

For brush motors

# H-bridge drivers (7V max.)

**BD6210, BD6211, BD6212, BD6215, BD6216, BD6217**

**●Overview**

These H-bridge drivers are full bridge drivers for brush motor applications. Each IC can operate at a wide range of power-supply voltages (from 3V to 36V), supporting output currents of up to 2A. MOS transistors in the output stage allow for PWM signal control, while the integrated VREF voltage control function of previous models offers direct replacement of deprecated motor driver ICs. These highly efficient H-bridge driver ICs facilitate low-power consumption design.

**●Features**

- 1) Built-in, selectable one channel or two channels configuration
- 2) Low standby current
- 3) Supports PWM control signal input (20kHz to 100kHz)
- 4) VREF voltage setting pin enables PWM duty control
- 5) Cross-conduction prevention circuit
- 6) Four protection circuits provided: OCP, OVP, TSD and UVLO

**●Applications**

VCR; CD/DVD players; audio-visual equipment; optical disc drives; PC peripherals;  
car audios; car navigation systems; OA equipments

**●Line up matrix**

Rating voltage	Channels	Maximum output current		
		0.5A	1.0A	2.0A
7V	1ch	BD6210 HFP / F	BD6211 HFP / F	BD6212 HFP / FP
	2ch	BD6215 FV / FP	BD6216 FP / FM	BD6217 FM
18V	1ch	BD6220 HFP / F	BD6221 HFP / F	BD6222 HFP / FP
	2ch	BD6225 FV / FP	BD6226 FP / FM	BD6227 FM
36V	1ch	BD6230 HFP / F	BD6231 HFP / F	BD6232 HFP / FP
	2ch	BD6235 FV / FP	BD6236 FP / FM	BD6237 FM

\* Packages; F:SOP8, FV: SSOPB24, HFP:HRP7, FP:HSOP25, FM:HSOPM28

Aug.2007

● **Absolute maximum ratings** (Ta=25°C)

Parameter	Symbol	Ratings	Unit
Supply voltage	VCC	7	V
Output current	IOMAX	0.5 * <sup>1</sup> / 1.0 * <sup>2</sup> / 2.0 * <sup>3</sup>	A
All other input pins	VIN	-0.3 ~ VCC	V
Operating temperature	TOPR	-40 ~ +85	°C
Storage temperature	TSTG	-55 ~ +150	°C
Power dissipation	Pd	0.687 * <sup>4</sup> / 0.98 * <sup>5</sup> / 1.4 * <sup>6</sup> / 1.45 * <sup>7</sup> / 2.2 * <sup>8</sup>	W
Junction temperature	Tjmax	150	°C

\*\*\* Notes: All voltages are with respect to ground.

\*1 BD6210 / BD6215. Do not, exceed Pd or ASO.

\*2 BD6211 / BD6216. Do not, exceed Pd or ASO.

\*3 BD6212 / BD6217. Do not, exceed Pd or ASO.

\*4 SOP8 package. Mounted on a 70mm x 70mm x 1.6mm FR4 glass-epoxy board with less than 3% copper foil. Derated at 5.5mW/°C above 25°C.

\*5 SSOPB24 package. Mounted on a 70mm x 70mm x 1.6mm FR4 glass-epoxy board with less than 3% copper foil. Derated at 7.8mW/°C above 25°C.

\*6 HRP7 package. Mounted on a 70mm x 70mm x 1.6mm FR4 glass-epoxy board with less than 3% copper foil. Derated at 11.2mW/°C above 25°C.

\*7 HSOP25 package. Mounted on a 70mm x 70mm x 1.6mm FR4 glass-epoxy board with less than 3% copper foil. Derated at 11.6mW/°C above 25°C.

\*8 HSOPM28 package. Mounted on a 70mm x 70mm x 1.6mm FR4 glass-epoxy board with less than 3% copper foil. Derated at 17.6mW/°C above 25°C.

● **Operating conditions** (Ta=25°C)

Parameter	Symbol	Conditions	Unit
Supply voltage	VCC	3.0 ~ 5.5	V
VREF voltage	VREF	1.5 ~ 5.5	V

● **Electrical characteristics** (Unless otherwise specified, Ta=25°C and VCC=VREF=5V)

Parameter	Symbol	Limits			Unit	Conditions
		Min.	Typ.	Max.		
Supply current	ICC	0.4	0.7	1.5	mA	Forward / Reverse / Brake
Stand-by current	ISTBY	-	0	10	μA	Stand-by
Input high voltage	VIH	2.0	-	-	V	
Input low voltage	VIL	-	-	0.8	V	
Input bias current	IiH	30	50	100	μA	VIN=5.0V
Output ON resistance * <sup>1</sup>	RON	0.5	1.0	1.5	Ω	Io=0.25A, vertically total
Output ON resistance * <sup>2</sup>	RON	0.5	1.0	1.5	Ω	Io=0.5A, vertically total
Output ON resistance * <sup>3</sup>	RON	0.2	0.5	1.0	Ω	Io=1.0A, vertically total
VREF bias current	IvREF	-10	0	10	μA	VREF=VCC
Carrier frequency	FPWM	20	25	35	kHz	VREF=3.75V
Input frequency range	FMAX	20	-	100	kHz	FIN / RIN

\*1 BD6210 / BD6215

\*2 BD6211 / BD6216

\*3 BD6212 / BD6217

● Electrical characteristic curves (Reference data)

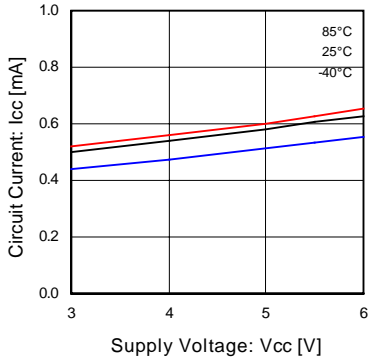

Fig.1 Supply current

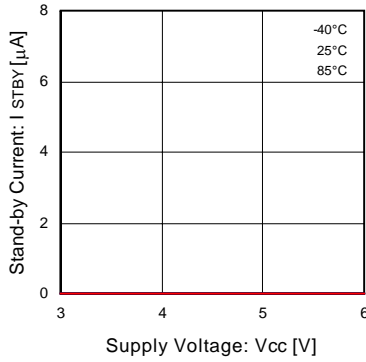

Fig.2 Stand-by current

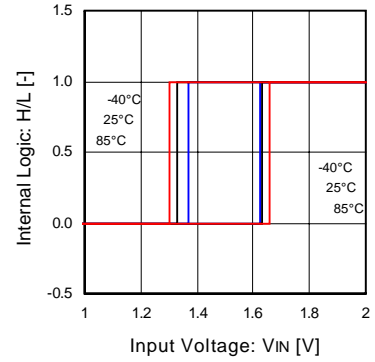

Fig.3 Input threshold voltage

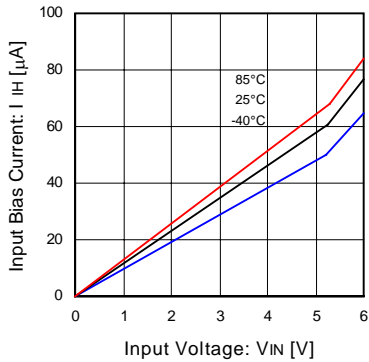

Fig.4 Input bias current

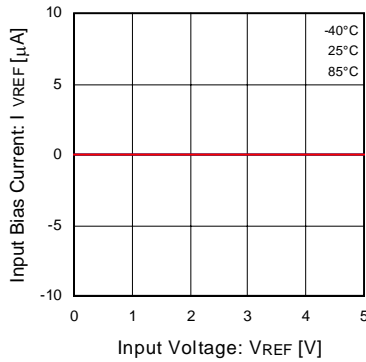

Fig.5 VREF input bias current

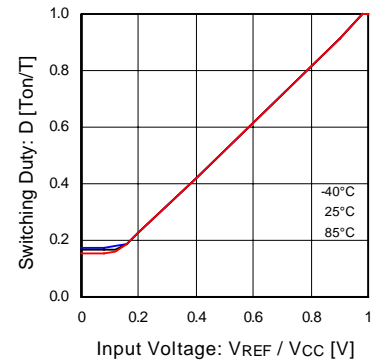

Fig.6 VREF - DUTY (VCC=5V)

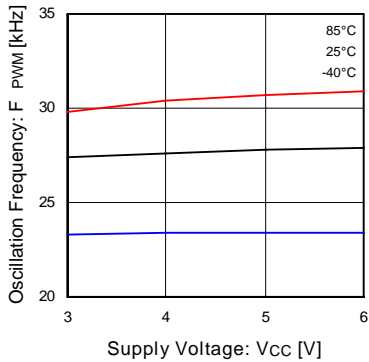

Fig.7 VCC - Carrier frequency

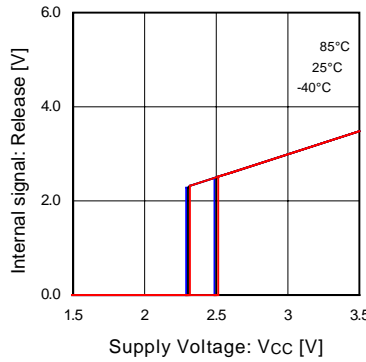

Fig.8 Under voltage lock out

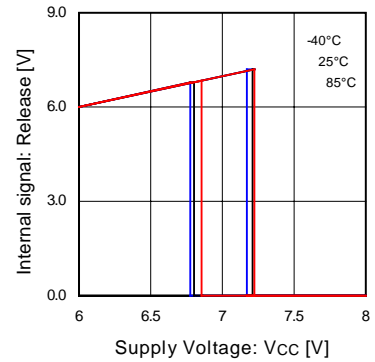

Fig.9 Over voltage protection

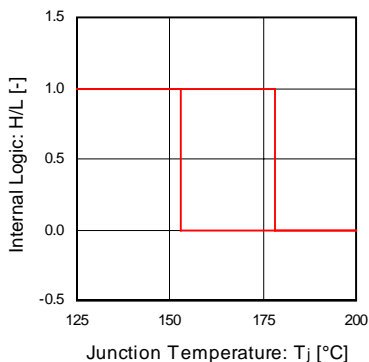

Fig.10 Thermal shutdown

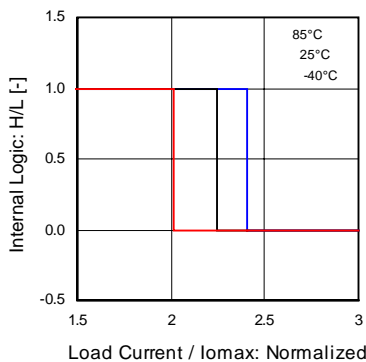

Fig.11 Over current protection (H side)

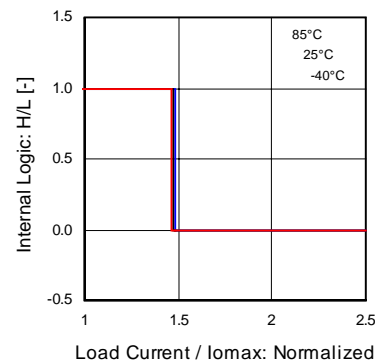

Fig.12 Over current protection (L side)

● **Electrical characteristic curves** (Reference data) – Continued

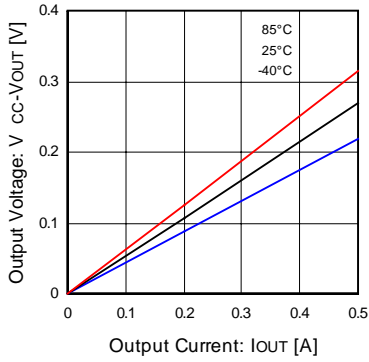

Fig.13 Output high voltage (0.5A class)

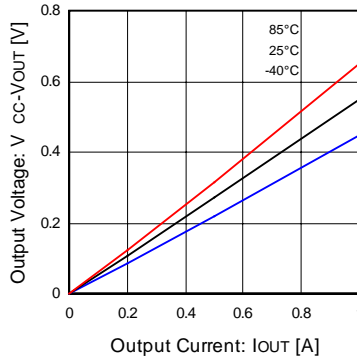

Fig.14 Output high voltage (1A class)

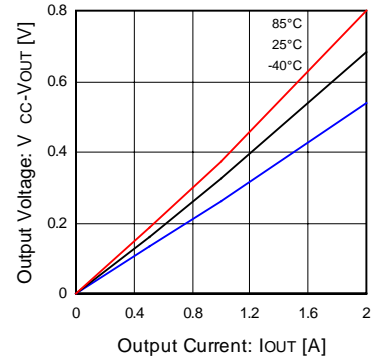

Fig.15 Output high voltage (2A class)

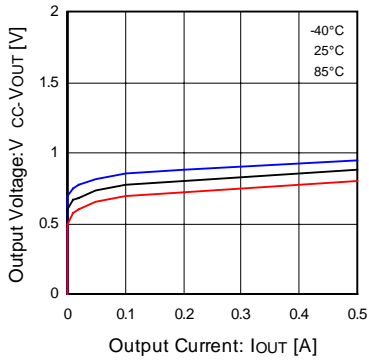

Fig.16 High side body diode (0.5A class)

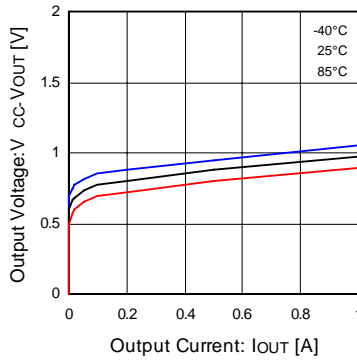

Fig.17 High side body diode (1A class)

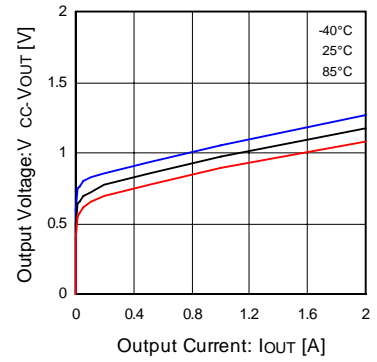

Fig.18 High side body diode (2A class)

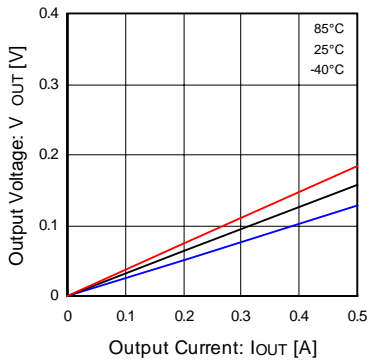

Fig.19 Output low voltage (0.5A class)

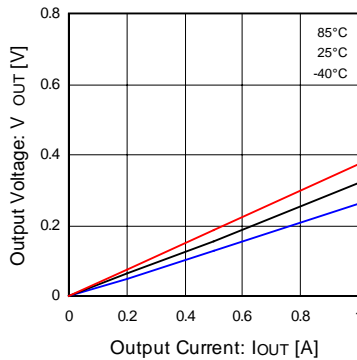

Fig.20 Output low voltage (1A class)

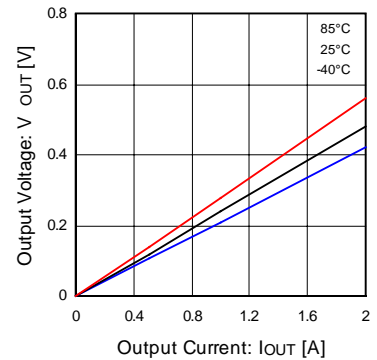

Fig.21 Output low voltage (2A class)

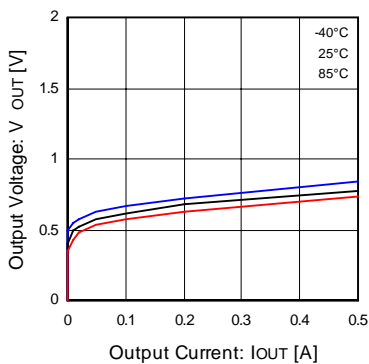

Fig.22 Low side body diode (0.5A class)

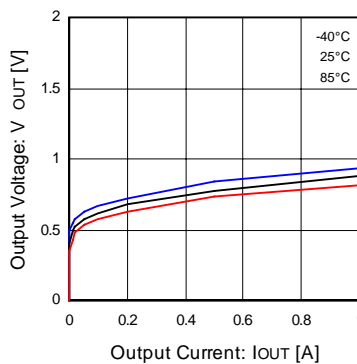

Fig.23 Low side body diode (1A class)

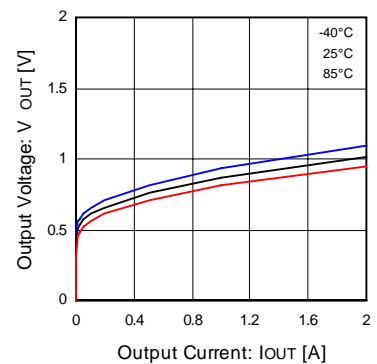

Fig.24 Low side body diode (2A class)

● Block diagram and pin configuration

**BD6210F / BD6211F**

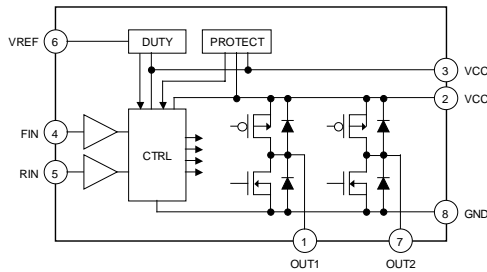

Fig.25 BD6210F / BD6211F

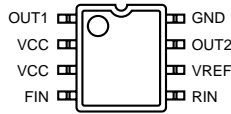

Fig.26 SOP8

Table 1 BD6210/11F

Pin	Name	Function
1	OUT1	Driver output
2	VCC	Power supply
3	VCC	Power supply
4	FIN	Control input (forward)
5	RIN	Control input (reverse)
6	VREF	Duty setting pin
7	OUT2	Driver output
8	GND	Ground

**BD6210HFP / BD6211HFP / BD6212HFP**

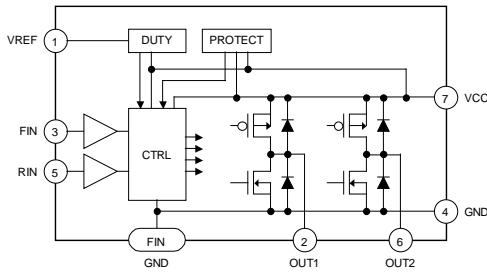

Fig.27 BD6210/11/12HFP

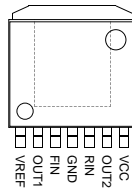

Fig.28 HRP7

Table 2 BD6210/11/12HFP

Pin	Name	Function
1	VREF	Duty setting pin
2	OUT1	Driver output
3	FIN	Control input (forward)
4	GND	Ground
5	RIN	Control input (reverse)
6	OUT2	Driver output
7	VCC	Power supply
8	GND	Ground

● Block diagram and pin configuration – Continued

**BD6212FP**

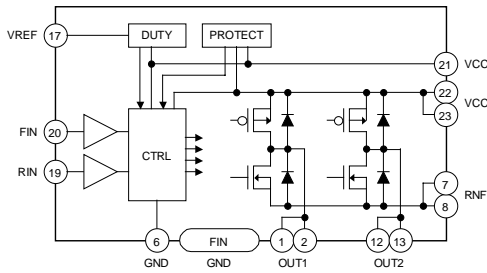

Fig.29 BD6212FP

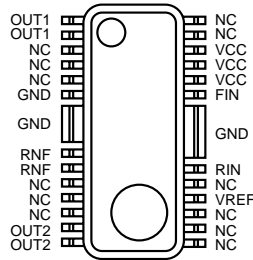

Fig.30 HSOP25

Table 3 BD6212FP

Pin	Name	Function
1,2	OUT1	Driver output
6	GND	Small signal ground
7,8	RNF	Power stage ground
12,13	OUT2	Driver output
17	VREF	Duty setting pin
19	RIN	Control input (reverse)
20	FIN	Control input (forward)
21	VCC	Power supply
22,23	VCC	Power supply
FIN	GND	Ground

Note: All pins not described above are NC pins.

**BD6215FV**

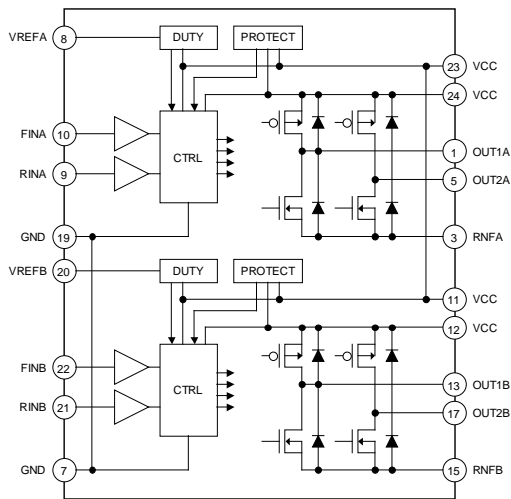

Fig. 31 BD6215FV

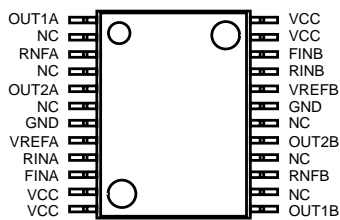

Fig. 32 SSOPB24

Table 4 BD6215FV

Pin	Name	Function
1	OUT1A	Driver output
3	RNFA	Power stage ground
5	OUT2A	Driver output
7	GND	Small signal ground
8	VREFA	Duty setting pin
9	RINA	Control input (reverse)
10	FINA	Control input (forward)
11	VCC	Power supply
12	VCC	Power supply
13	OUT1B	Driver output
15	RNFB	Power stage ground
17	OUT2B	Driver output
19	GND	Small signal ground
20	VREFB	Duty setting pin
21	RINB	Control input (reverse)
22	FINB	Control input (forward)
23	VCC	Power supply
24	VCC	Power supply

Note: All pins not described above are NC pins.

● Block diagram and pin configuration – Continued

**BD6215FP, BD6216FP/FM**

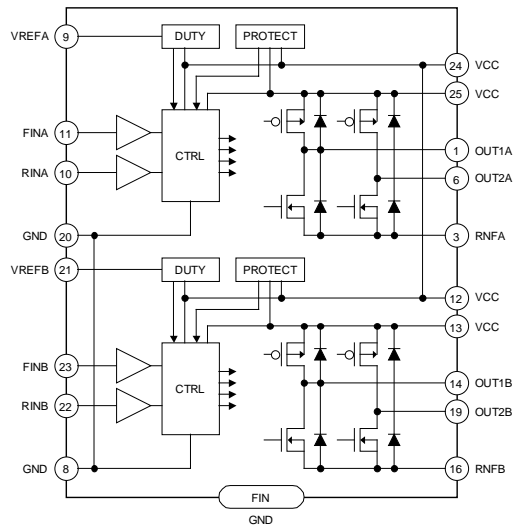

Fig. 33 BD6215FP, BD6216FP

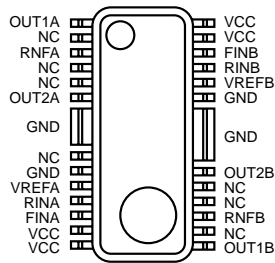

Fig. 34 HSOP25

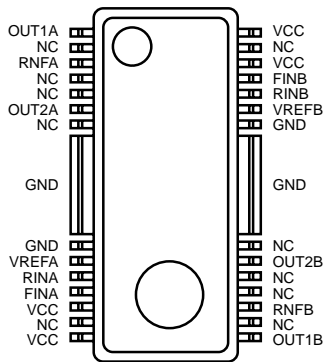

Fig. 35 HSOPM28

Table 5 BD6215FP / BD6216FP

Pin	Name	Function
1	OUT1A	Driver output
3	RNFA	Power stage ground
6	OUT2A	Driver output
8	GND	Small signal ground
9	VREFA	Duty setting pin
10	RINA	Control input (reverse)
11	FINA	Control input (forward)
12	VCC	Power supply
13	VCC	Power supply
14	OUT1B	Driver output
16	RNFB	Power stage ground
19	OUT2B	Driver output
20	GND	Small signal ground
21	VREFB	Duty setting pin
22	RINB	Control input (reverse)
23	FINB	Control input (forward)
24	VCC	Power supply
25	VCC	Power supply
FIN	GND	Ground

Note: All pins not described above are NC pins.

Table 6 BD6216FM

Pin	Name	Function
1	OUT1A	Driver output
3	RNFA	Power stage ground
6	OUT2A	Driver output
8	GND	Small signal ground
9	VREFA	Duty setting pin
10	RINA	Control input (reverse)
11	FINA	Control input (forward)
12	VCC	Power supply
14	VCC	Power supply
15	OUT1B	Driver output
17	RNFB	Power stage ground
20	OUT2B	Driver output
22	GND	Small signal ground
23	VREFB	Duty setting pin
24	RINB	Control input (reverse)
25	FINB	Control input (forward)
26	VCC	Power supply
28	VCC	Power supply
FIN	GND	Ground

Note: All pins not described above are NC pins.

● Block diagram and pin configuration – Continued

**BD6217FM**

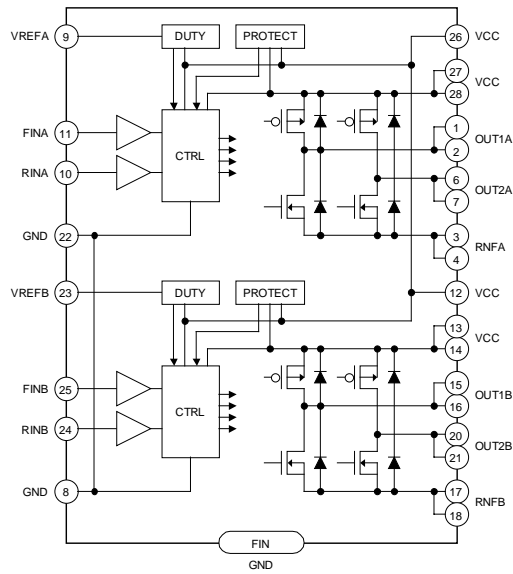

Fig. 36 BD6217FM

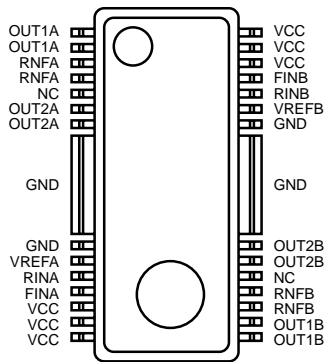

Fig. 37 HSOPM28

Table 7 BD6217FM

Pin	Name	Function
1,2	OUT1A	Driver output
3,4	RNF A	Power stage ground
6,7	OUT2A	Driver output
8	GND	Small signal ground
9	VREFA	Duty setting pin
10	RINA	Control input (reverse)
11	FINA	Control input (forward)
12	VCC	Power supply
13,14	VCC	Power supply
15,16	OUT1B	Driver output
17,18	RNFB	Power stage ground
20,21	OUT2B	Driver output
22	GND	Small signal ground
23	VREFB	Duty setting pin
24	RINB	Control input (reverse)
25	FINB	Control input (forward)
26	VCC	Power supply
27,28	VCC	Power supply
FIN	GND	Ground

Note: All pins not described above are NC pins.



● Functional descriptions

1) Operation modes

Table 8 Logic table

	FIN	RIN	VREF	OUT1	OUT2	Operation
a	L	L	X	Hi-Z*	Hi-Z*	Stand-by (idling)
b	H	L	VCC	H	L	Forward (OUT1 > OUT2)
c	L	H	VCC	L	H	Reverse (OUT1 < OUT2)
d	H	H	X	L	L	Brake (stop)
e	PWM	L	VCC	H	$\overline{\text{PWM}}$	Forward (PWM control)
f	L	PWM	VCC	$\overline{\text{PWM}}$	H	Reverse (PWM control)
g	H	L	Option	H	$\overline{\text{PWM}}$	Forward (VREF control)
h	L	H	Option	$\overline{\text{PWM}}$	H	Reverse (VREF control)

\* Hi-Z is the off state of all output transistors. Please note that this is the state of the connected diodes, which differs from that of the mechanical relay.

X : Don't care

a) Stand-by mode

Stand-by operates independently of the VREF pin voltage. In stand-by mode, all internal circuits are turned off, including the output power transistors. Motor output goes to high impedance. If the motor is running at the switch to stand-by mode, the system enters an idling state because of the body diodes. However, when the system switches to stand-by from any other mode (except the brake mode), the control logic remains in the high state for at least 50µs before shutting down all circuits.

b) Forward mode

This operating mode is defined as the forward rotation of the motor when the OUT1 pin is high and OUT2 pin is low. When the motor is connected between the OUT1 and OUT2 pins, the current flows from OUT1 to OUT2. For operation in this mode, connect the VREF pin with VCC pin.

c) Reverse mode

This operating mode is defined as the reverse rotation of the motor when the OUT1 pin is low and OUT2 pin is high. When the motor is connected between the OUT1 and OUT2 pins, the current flows from OUT2 to OUT1. For operation in this mode, connect the VREF pin with VCC pin.

d) Brake mode

This operating mode is used to quickly stop the motor (short circuit brake). It differs from the stand-by mode because the internal control circuit is operating in the brake mode. Please switch to the stand-by mode (rather than the brake mode) to save power and reduce consumption.

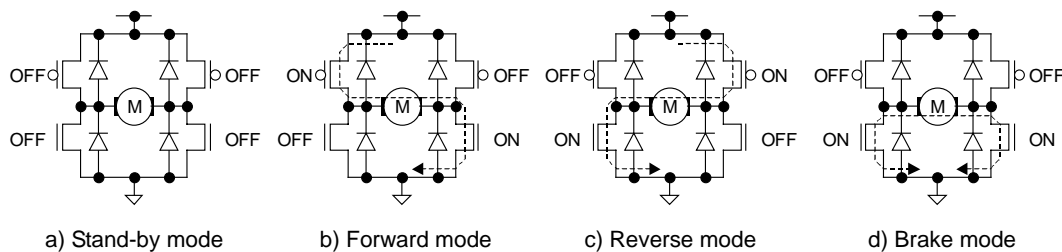

Fig.38 Four basic operations (output stage)

e) f) PWM control mode

The rotational speed of the motor can be controlled by the switching duty when the PWM signal is input to the FIN pin or the RIN pin. In this mode, the high side output is fixed and the low side output does the switching, corresponding to the input signal. The switching operates by the output state toggling between "L" and "Hi-Z".

The PWM frequency can be input in the range between 20kHz and 100kHz. Note that control may not be attained by switching on duty at frequencies lower than 20kHz, since the operation functions via the stand-by mode. Also, circuit operation may not respond correctly when the input signal is higher than 100kHz. To operate in this mode, connect the VREF pin with VCC pin. In addition, establish a current path for the recovery current from the motor, by connecting a bypass capacitor (10µF or more is recommended) between VCC and ground.

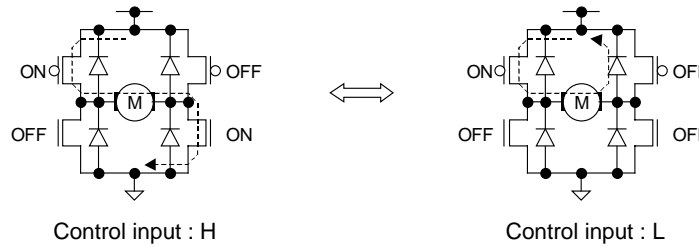

Fig.39 PWM control operation (output stage)

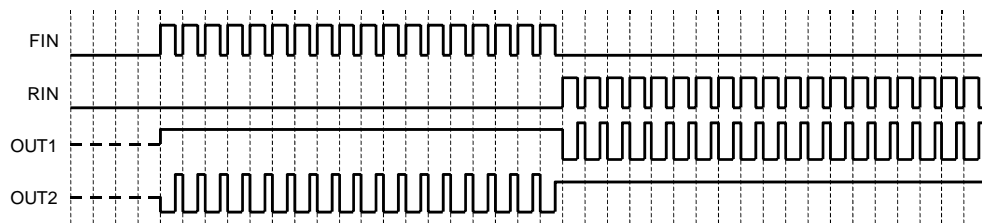

Fig.40 PWM control operation (timing chart)

g) h) VREF control mode

The built-in VREF-switching on duty conversion circuit provides switching duty corresponding to the voltage of the VREF pin and the VCC voltage. The function offers the same level of control as the high voltage output setting function in previous models. The on duty is shown by the following equation.

$$\text{DUTY} \approx \text{VREF [V]} / \text{VCC [V]}$$

For example, if VCC voltage is 5V and VREF pin voltage is 3.75V, the switching on duty is about 75 percent. However, please note that the switching on duty might be limited by the range of VREF pin voltage (Refer to the operating conditions, shown on page 2). The PWM carrier frequency in this mode is 25kHz (nominal), and the switching operation is the same as it is the PWM control modes. When operating in this mode, do not input the PWM signal to the FIN and RIN pins. In addition, establish a current path for the recovery current from the motor, by connecting a bypass capacitor (10µF or more is recommended) between VCC and ground.

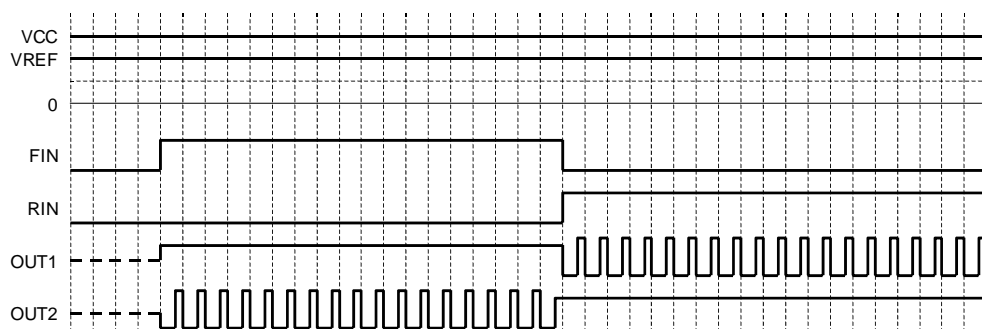

Fig.41 VREF control operation (timing chart)

## 2) Cross-conduction protection circuit

In the full bridge output stage, when the upper and lower transistors are turned on at the same time, and this condition exists during the period of transition from high to low, or low to high, a rush current flows from the power supply to ground, resulting in a loss. This circuit protects against the rush current by providing a dead time (about 400ns, nominal) at the transition.

## 3) Output protection circuits

### a) Under voltage lock out (UVLO) circuit

To secure the lowest power supply voltage necessary to operate the controller, and to prevent under voltage malfunctions, a UVLO circuit has been built into this driver. When the power supply voltage falls to 2.3V (nominal) or below, the controller forces all driver outputs to high impedance. When the voltage rises to 2.5V (nominal) or above, the UVLO circuit ends the lockout operation and returns the chip to normal operation.

### b) Over voltage protection (OVP) circuit

When the power supply voltage exceeds 7.3V (nominal), the controller forces all driver outputs to high impedance. The OVP circuit is released and its operation ends when the voltage drops back to 6.8V (nominal) or below. This protection circuit does not work in the stand-by mode. Also, note that this circuit is supplementary, and thus if it is asserted, the absolute maximum rating will have been exceeded. Therefore, do not continue to use the IC after this circuit is activated, and do not operate the IC in an environment where activation of the circuit is assumed.

### c) Thermal shutdown (TSD) circuit

The TSD circuit operates when the junction temperature of the driver exceeds the preset temperature (175°C nominal). At this time, the controller forces all driver outputs to high impedance. Since thermal hysteresis is provided in the TSD circuit, the chip returns to normal operation when the junction temperature falls below the preset temperature (150°C nominal). Thus, it is a self-returning type circuit.

The TSD circuit is designed only to shut the IC off to prevent thermal runaway. It is not designed to protect the IC or guarantee its operation in the presence of extreme heat. Do not continue to use the IC after the TSD circuit is activated, and do not operate the IC in an environment where activation of the circuit is assumed.

### d) Over current protection (OCP) circuit

To protect this driver IC from ground faults, power supply line faults and load short circuits, the OCP circuit monitors the output current for the circuit's monitoring time (10 $\mu$ s, nominal). When the protection circuit detects an over current, the controller forces all driver outputs to high impedance during the off time (290 $\mu$ s, nominal). The IC returns to normal operation after the off time period has elapsed (self-returning type). At the two channels type, this circuit works independently for each channel.

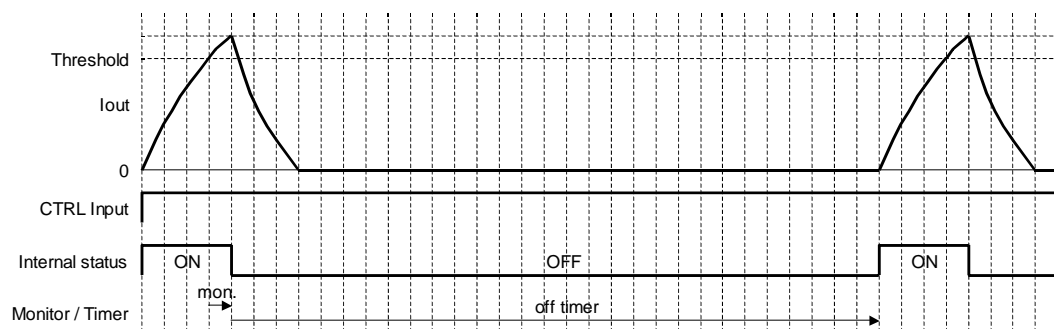

Fig.42 Over current protection (timing chart)

● Thermal design

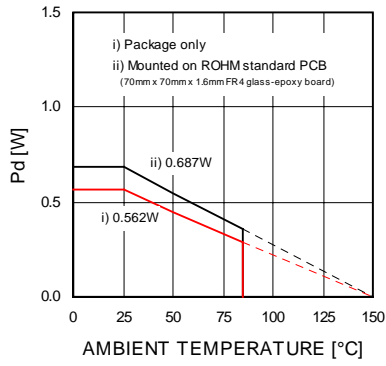

Fig.43 Thermal derating curve (SOP8)

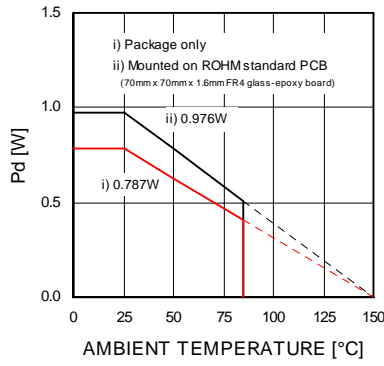

Fig.44 Thermal derating curve (SSOPB24)

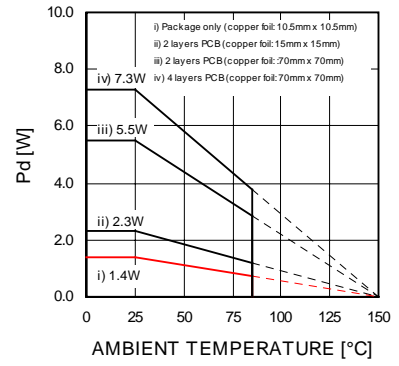

Fig.45 Thermal derating curve (HRP7)

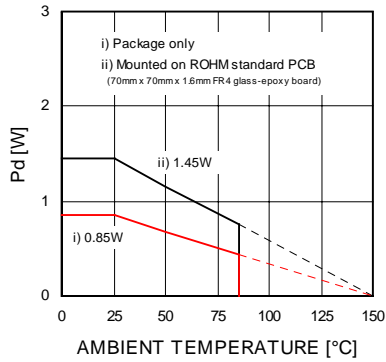

Fig.46 Thermal derating curve (HSOP25)

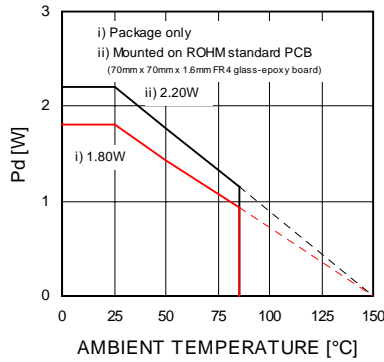

Fig.47 Thermal derating curve (HSOPM28)

Table 9 Thermal resistance

Package	$\theta_{j-a}$ [°C/W]
SOP8	182
SSOPB24	122
HRP7	89.3
HSOP25	86.2
HSOP28	56.8

Mounted on a 70mmx70mmx1.6mm FR4 glass-epoxy board with less than 3% copper foil.

Thermal design needs to meet the following operating conditions.

In creating the thermal design, sufficient margin must be provided to guarantee the temperature conditions below.

1. The ambient temperature  $T_a$  must be 85°C or below
2. The junction temperature  $T_j$  must be 150°C or below

The junction temperature  $T_j$  can be determined using the following equation.

$$T_j \approx T_a + \theta_{j-a} \times P_c \text{ [°C]}$$

The power consumption  $P_c$  can be determined using the following equation. Refer to page 4 about  $V_{ON(H)}$  and  $V_{F(H)}$ .

$$P_c \approx (I_{OUT}^2 \times R_{ON}) \times (V_{REF} / V_{CC}) + I_{OUT} \times (V_{ON(H)} + V_{F(H)}) \times (1 - V_{REF} / V_{CC}) + V_{CC} \times I_{CC} \text{ [W]}$$

Example using the BD6211F

Conditions:  $T_a=50^\circ\text{C}$ ,  $V_{CC}=V_{REF}=5\text{V}$ ,  $I_{out}=0.1\text{A}$ .

The power consumption of the IC and the junction temperature are as follows:

$$P_c \approx 0.1^2 \times 1.0 + 5 \times 0.7\text{m} = 13.5\text{mW}$$

$$T_j \approx 50 + 182 \times 13.5\text{m} = 52.5 \text{ [°C]}$$

Where the  $T_{jmax}$  parameter is 150°C and the derating is set to 80 percents, the maximum ambient temperature  $T_{amax}$  is determined as follows.

$$T_a \leq T_{jmax} \times 0.8 - \theta_{j-a} \times P_c \approx 115 \text{ [°C]}$$

In this example, thermal design can be considered satisfactory (meaning that there are no problems in thermal design), since the system meets the operating temperature conditions.

## ● Interfaces

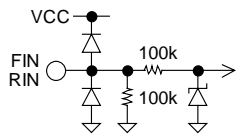

Fig.48 FIN / RIN

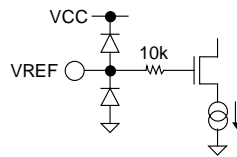

Fig.49 VREF

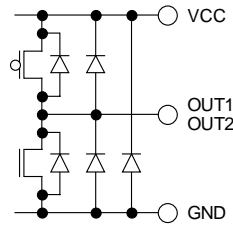

Fig.50 OUT1 / OUT2  
(SOP8/HRP7)

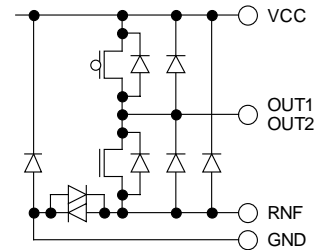

Fig.51 OUT1 / OUT2  
(SSOPB24/HSOP25/HSOPM28)

## ● NOTES FOR USE

### 1) Absolute maximum ratings

Devices may be destroyed when supply voltage or operating temperature exceeds the absolute maximum rating. Because the cause of this damage cannot be identified as, for example, a short circuit or an open circuit, it is important to consider circuit protection measures – such as adding fuses – if any value in excess of absolute maximum ratings is to be implemented.

### 2) Connecting the power supply connector backward

Connecting the power supply in reverse polarity can damage the IC. Take precautions against reverse polarity when connecting the power supply lines, such as adding an external direction diode.

### 3) Power supply lines

Return current generated by the motor's Back-EMF requires countermeasures, such as providing a return current path by inserting capacitors across the power supply and GND. In this case, it is important to conclusively confirm that none of the negative effects sometimes seen with electrolytic capacitors – including a capacitance drop at low temperatures - occurs. Also, the connected power supply must have sufficient current absorbing capability. Otherwise, the regenerated current will increase voltage on the power supply line, which may in turn cause problems with the product, including peripheral circuits exceeding the absolute maximum rating. To help protect against damage or degradation, physical safety measures should be taken, such as providing a voltage clamping diode across the power supply and GND.

### 4) Electrical potential at GND

Keep the GND terminal potential to the minimum potential under any operating condition. In addition, check to determine whether there is any terminal that provides voltage below GND, including the voltage during transient phenomena. When both a small signal GND and high current GND are present, single-point grounding (at the set's reference point) is recommended, in order to separate the small signal and high current GND, and to ensure that voltage changes due to the wiring resistance and high current do not affect the voltage at the small signal GND. In the same way, care must be taken to avoid changes in the GND wire pattern in any external connected component.

### 5) Thermal design

Use a thermal design that allows for a sufficient margin in light of the power dissipation (Pd) under actual operating conditions.

### 6) Inter-pin shorts and mounting errors

Use caution when positioning the IC for mounting on printed circuit boards. The IC may be damaged if there is any connection error, or if pins are shorted together.

### 7) Operation in strong electromagnetic fields

Using this product in strong electromagnetic fields may cause IC malfunctions. Use extreme caution with electromagnetic fields.

8) ASO - Area of Safety Operation

When using the IC, set the output transistor so that it does not exceed absolute maximum ratings or ASO.

9) Built-in thermal shutdown (TSD) circuit

The TSD circuit is designed only to shut the IC off to prevent thermal runaway. It is not designed to protect the IC or guarantee its operation in the presence of extreme heat. Do not continue to use the IC after the TSD circuit is activated, and do not operate the IC in an environment where activation of the circuit is assumed.

10) Capacitor between output and GND

In the event a large capacitor is connected between the output and GND, if VCC and VIN are short-circuited with 0V or GND for any reason, the current charged in the capacitor flows into the output and may destroy the IC. Use a capacitor smaller than 1µF between output and GND.

11) Testing on application boards

When testing the IC on an application board, connecting a capacitor to a low impedance pin subjects the IC to stress. Therefore, always discharge capacitors after each process or step. Always turn the IC's power supply off before connecting it to or removing it from the test setup during the inspection process. Ground the IC during assembly steps as an antistatic measure. Use similar precaution when transporting or storing the IC.

12) Switching noise

When the operation mode is in PWM control or VREF control, PWM switching noise may effects to the control input pins and cause IC malfunctions. In this case, insert a pulled down resistor (10kΩ is recommended) between each control input pin and ground.

13) Regarding the input pin of the IC

This monolithic IC contains P+ isolation and P substrate layers between adjacent elements, in order to keep them isolated.

P-N junctions are formed at the intersection of these P layers with the N layers of other elements, creating a parasitic diode or transistor. For example, the relation between each potential is as follows:

When GND > Pin A and GND > Pin B, the P-N junction operates as a parasitic diode.

When GND > Pin B, the P-N junction operates as a parasitic transistor.

Parasitic diodes inevitably occur in the structure of the IC. The operation of parasitic diodes can result in mutual interference among circuits, as well as operating malfunctions and physical damage. Therefore, do not use methods by which parasitic diodes operate, such as applying a voltage lower than the GND (P substrate) voltage to an input pin.

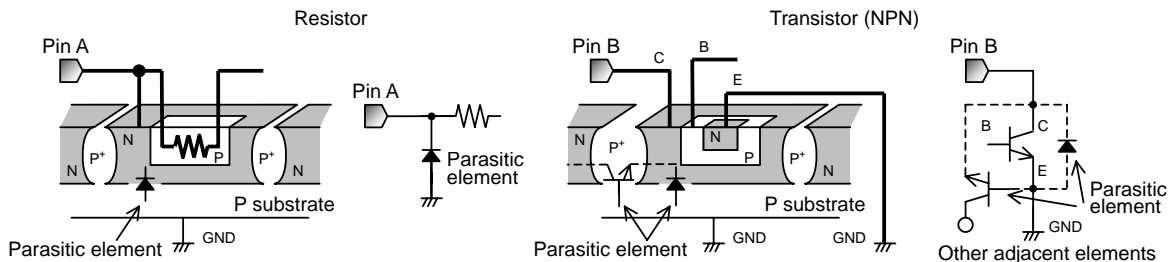

Appendix: Example of monolithic IC structure

● Ordering part number

B	D	6	2	X	X	-			
ROHM part number		Type				Package		Packaging spec.	
		1X: 7V max.				F: SOP8		E2: Embossed taping	
		2X: 18V max.				FV: SSOPB24		(SOP8/SSOPB24	
		3X: 36V max.				FP: HSOP25		/HSOP25/HSOPM28)	
		X0: 1ch/0.5A		X5: 2ch/0.5A		FM: HSOPM28		TR: Embossed taping	
		X1: 1ch/1A		X6: 2ch/1A		HFP: HRP7		(HRP7)	
		X2: 1ch/2A		X7: 2ch/2A					

## SOP8

### <Dimension>

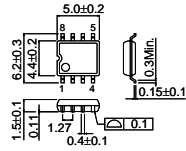

(Unit:mm)

### <Tape and reel information>

Tape	Embossed carrier tape
Quantity	2500pcs
Direction of feed	E2 (Holding the reel with the left hand and pulling the tape out with the right, pin 1 will be on the upper left-hand side.)

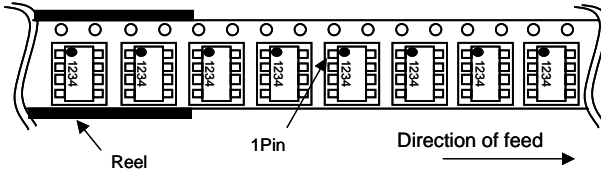

※Orders should be placed in multiples of package quantity.

## SSOP-B24

### <Dimension>

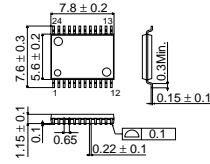

(Unit:mm)

### <Tape and Reel information>

Tape	Embossed carrier tape
Quantity	2000pcs
Direction of feed	E2 (Holding the reel with the left hand and pulling the tape out with the right, pin 1 will be on the upper left-hand side.)

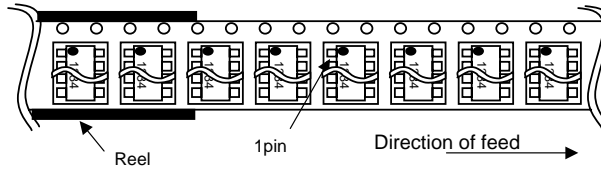

※Orders should be placed in multiples of package quantity.

## HSOP25

### <Dimension>

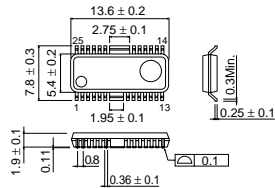

(Unit:mm)

### <Tape and reel information>

Tape	Embossed carrier tape
Quantity	2000pcs
Direction of feed	E2 (Holding the reel with the left hand and pulling the tape out with the right, pin 1 will be on the upper left-hand side.)

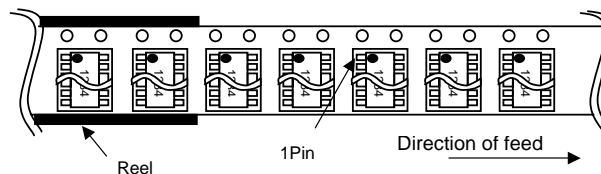

※Orders should be placed in multiples of package quantity.

## HSOP-M28

### <Dimension>

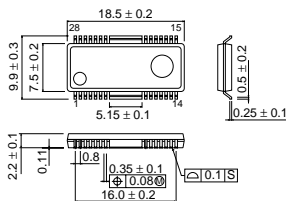

(Unit:mm)

### <Tape and reel information>

Tape	Embossed carrier tape
Quantity	1500pcs
Direction of feed	E2 (Holding the reel with the left hand and pulling the tape out with the right, pin 1 will be on the upper left-hand side.)

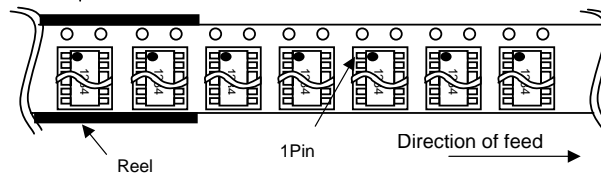

※Orders should be placed in multiples of package quantity.

# HRP7

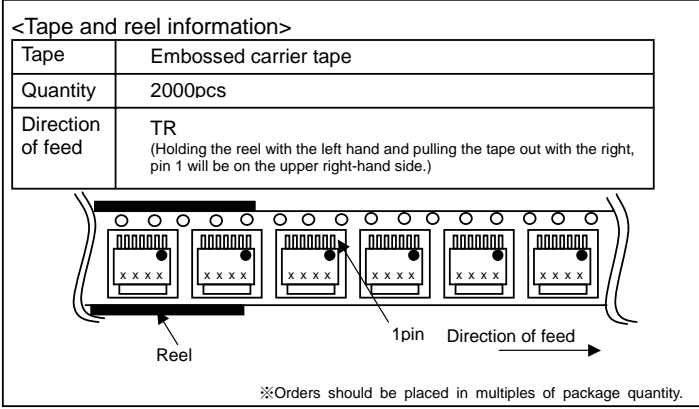
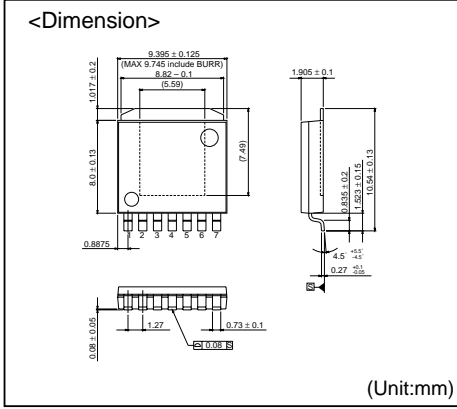

- The contents described herein are correct as of April, 2005
- The contents described herein are subject to change without notice. For updates of the latest information, please contact and confirm with ROHM CO.,LTD.
- Any part of this application note must not be duplicated or copied without our permission.
- Application circuit diagrams and circuit constants contained herein are shown as examples of standard use and operation. Please pay careful attention to the peripheral conditions when designing circuits and deciding upon circuit constants in the set.
- Any data, including, but not limited to application circuit diagrams and information, described herein are intended only as illustrations of such devices and not as the specifications for such devices. ROHM CO.,LTD. disclaims any warranty that any use of such devices shall be free from infringement of any third party's intellectual property rights or other proprietary rights, and further, assumes no liability of whatsoever nature in the event of any such infringement, or arising from or connected with or related to the use of such devices.
- Upon the sale of any such devices, other than for buyer's right to use such devices itself, resell or otherwise dispose of the same, implied right or license to practice or commercially exploit any intellectual property rights or other proprietary rights owned or controlled by ROHM CO., LTD. is granted to any such buyer.
- The products described herein utilize silicon as the main material.
- The products described herein are not designed to be X ray proof.

The products listed in this catalog are designed to be used with ordinary electronic equipment or devices (such as audio visual equipment, office-automation equipment, communications devices, electrical appliances and electronic toys). Should you intend to use these products with equipment or devices which require an extremely high level of reliability and the malfunction of which would directly endanger human life (such as medical instruments, transportation equipment, aerospace machinery, nuclear-reactor controllers, fuel controllers and other safety devices), please be sure to consult with our sales representative in advance.

Excellence in Electronics



## ROHM CO., LTD.

21, Saiin Mizosaki-cho, Ukyo-ku, Kyoto  
615-8585, Japan  
TEL: (075)311-2121 FAX: (075)315-0172  
URL: <http://www.rohm.com>

Published by  
LSI Application Engineering Group

Contact us for further information about the products.

Atlanta U.S.A. / ROHM ELECTRONICS ATLANTA SALES OFFICE  
(DIVISION OF ROHM ELE.U.S.A.,LLC.)  
TEL: +1(770)754-5972 FAX: +1(770)754-0691  
Dallas U.S.A. / ROHM ELECTRONICS DALLAS SALES OFFICE  
(DIVISION OF ROHM ELE.U.S.A.,LLC.)  
TEL: +1(972)312-8818 FAX: +1(972)312-0330  
San Diego U.S.A. / ROHM ELECTRONICS SAN DIEGO SALES OFFICE  
(DIVISION OF ROHM ELE.U.S.A.,LLC.)  
TEL: +1(858)625-3630 FAX: +1(858)625-3670  
Germany / ROHM ELECTRONICS GMBH (GERMANY)  
TEL: +49(2154)9210 FAX: +49(2154)921400  
United Kingdom / ROHM ELECTRONICS GMBH (UK)  
TEL: +44(0)1908-306700 FAX: +44(0)1908-235788  
France / ROHM ELECTRONICS GMBH (FRANCE)  
TEL: +33(141)231400 FAX: +33(141)231430  
Hong Kong China / ROHM ELECTRONICS (H.K.) CO., LTD.  
TEL: +852(2)7406262 FAX: +852(2)375-8971  
Shanghai China / ROHM ELECTRONICS (SHANGHAI) CO., LTD.  
TEL: +86(21)6279-2727 FAX: +86(21)6247-2066

Dalian China / ROHM ELECTRONICS TRADING (DALIAN) CO., LTD.  
TEL: +86(411)8230-9549 FAX: +86(411)8230-8537  
Beijing China / BEIJING REPRESENTATIVE OFFICE  
TEL: +86(10)8525-2483 FAX: +86(10)8525-2489  
Taiwan / ROHM ELECTRONICS TAIWAN CO., LTD.  
TEL: +886(2)2500-6956 FAX: +886(2)2500-2669  
Korea / ROHM ELECTRONICS KOREA CORPORATION  
TEL: +82(2)8182-700 FAX: +82(2)8182-715  
Singapore / ROHM ELECTRONICS ASIA PTE LTD. (RES/REI)  
TEL: +65-6332-2322 FAX: +65-6332-6562  
Malaysia / ROHM ELECTRONICS (MALAYSIA) SDN. BHD.  
TEL: +60(3)7958-8355 FAX: +60(3)7958-8377  
Philippines / ROHM ELECTRONICS (PHILIPPINES) SALES CORPORATION  
TEL: +63(2)807-8872 FAX: +63(2)808-1422  
Thailand / ROHM ELECTRONICS (THAILAND) CO., LTD.  
TEL: +66(2)254-4890 FAX: +66(2)256-6334

Catalog NO.05N000A'05.4 ROHM ©3000 TSU



### Notes

- No technical content pages of this document may be reproduced in any form or transmitted by any means without prior permission of ROHM CO.,LTD.
- The contents described herein are subject to change without notice. The specifications for the product described in this document are for reference only. Upon actual use, therefore, please request that specifications to be separately delivered.
- Application circuit diagrams and circuit constants contained herein are shown as examples of standard use and operation. Please pay careful attention to the peripheral conditions when designing circuits and deciding upon circuit constants in the set.
- Any data, including, but not limited to application circuit diagrams information, described herein are intended only as illustrations of such devices and not as the specifications for such devices. ROHM CO.,LTD. disclaims any warranty that any use of such devices shall be free from infringement of any third party's intellectual property rights or other proprietary rights, and further, assumes no liability of whatsoever nature in the event of any such infringement, or arising from or connected with or related to the use of such devices.
- Upon the sale of any such devices, other than for buyer's right to use such devices itself, resell or otherwise dispose of the same, no express or implied right or license to practice or commercially exploit any intellectual property rights or other proprietary rights owned or controlled by
- ROHM CO., LTD. is granted to any such buyer.
- Products listed in this document are no antiradiation design.

The products listed in this document are designed to be used with ordinary electronic equipment or devices (such as audio visual equipment, office-automation equipment, communications devices, electrical appliances and electronic toys).

Should you intend to use these products with equipment or devices which require an extremely high level of reliability and the malfunction of which would directly endanger human life (such as medical instruments, transportation equipment, aerospace machinery, nuclear-reactor controllers, fuel controllers and other safety devices), please be sure to consult with our sales representative in advance.

It is our top priority to supply products with the utmost quality and reliability. However, there is always a chance of failure due to unexpected factors. Therefore, please take into account the derating characteristics and allow for sufficient safety features, such as extra margin, anti-flammability, and fail-safe measures when designing in order to prevent possible accidents that may result in bodily harm or fire caused by component failure. ROHM cannot be held responsible for any damages arising from the use of the products under conditions out of the range of the specifications or due to non-compliance with the NOTES specified in this catalog.

Thank you for your accessing to ROHM product informations.

More detail product informations and catalogs are available, please contact your nearest sales office.

**ROHM** Customer Support System

THE AMERICAS / EUROPE / ASIA / JAPAN

[www.rohm.com](http://www.rohm.com)

Contact us : [webmaster@rohm.co.jp](mailto:webmaster@rohm.co.jp)