

Features

- On Chip Hall Sensor
- Rotor-Locked Shutdown
- Automatically Restart
- Built-in Zener Protection for Output Driver
- Operating Voltage: 1.8V~5.75 V
- Output Current: $I_{O(AVE)} = 400 \text{ mA}$
- Packages: SIP-4L, SOT25, and SOT89-5L

General Description

AH291 is a monolithic fan motor controller with Hall sensor's capability. It contains two complementary open-collector drivers for motor's coil driving, automatic lock shutdown and restart function relatively.

Rotor-lock shutdown detection circuit turns off the output driver when the rotor is blocked to avoid coil overheat. Then, the automatic recovery circuit will restart the motor. These protected actions are repeated and periodic during the blocked period. Until the blocking is removed, the motor recovers and runs normally.

Ordering Information

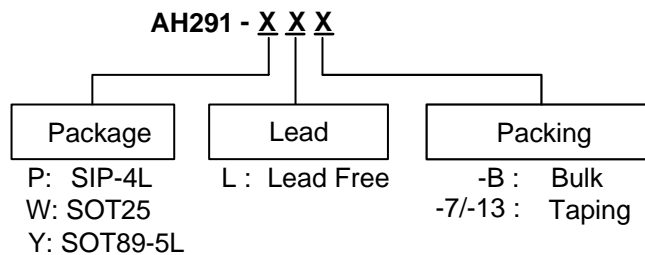

Note: 1. RoHS revision 13.2.2003. Glass and High Temperature Solder Exemptions Applied, see *EU Directive Annex Notes 5 and 7*.

Device	Package Code	Packaging (Note 2)	Tube/Bulk		7" Tape and Reel	
			Quantity	Part Number Suffix	Quantity	Part Number Suffix
AH291-P	P	SIP-4L	1000	-B	NA	NA
AH291-W	W	SOT25	NA	NA	3000/Tape & Reel	-7
AH291-Y	Y	SOT89-5L	NA	NA	2500/Tape & Reel	-13

Note: 2. Pad layout as shown on Diodes Inc. suggested pad layout document AP02001, which can be found on our website at <http://www.diodes.com/datasheets/ap02001.pdf>.

Pin Assignment

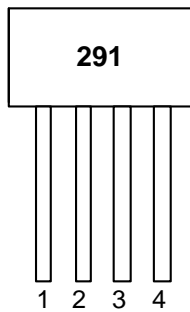

SIP-4L

Front View

- 1 : V_{dd}
- 2 : DO
- 3 : DOB
- 4 : GND

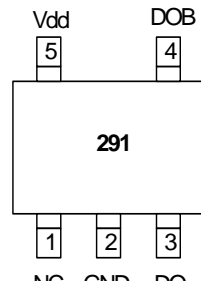

SOT25

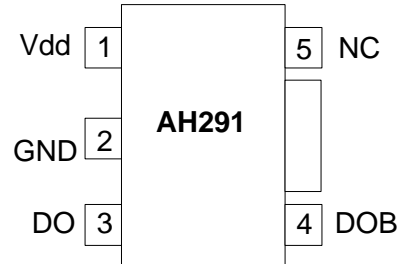

SOT89-5L

Pin Descriptions

Name	Description
V _{dd}	Input Power
DO	Output Pin
DOB	Output Pin
GND	Ground
NC	Not Connected

Block Diagram (SIP-4L)

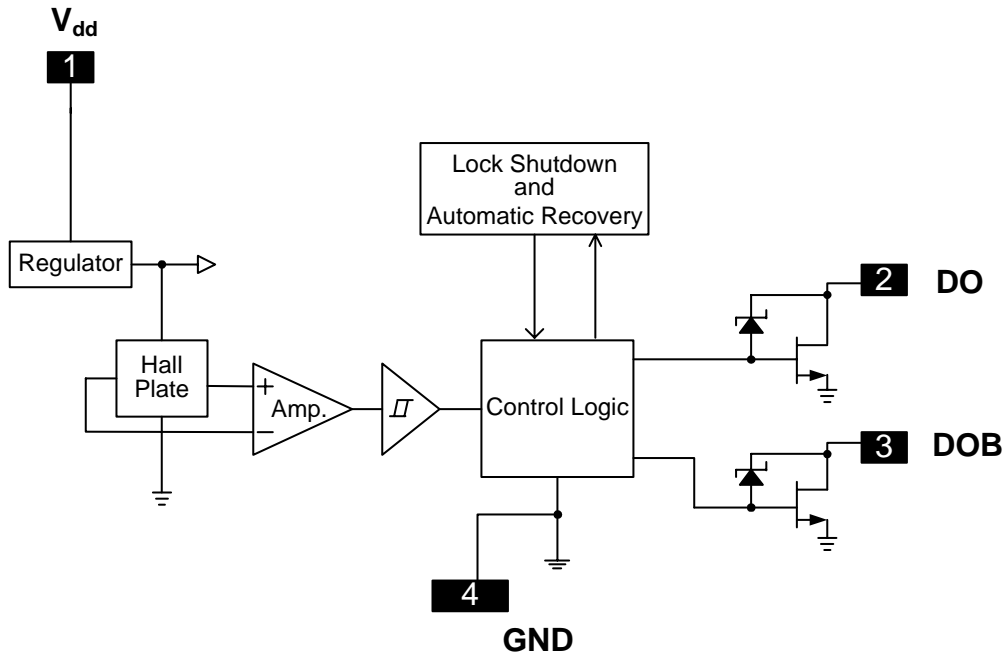

Typical Application Circuit

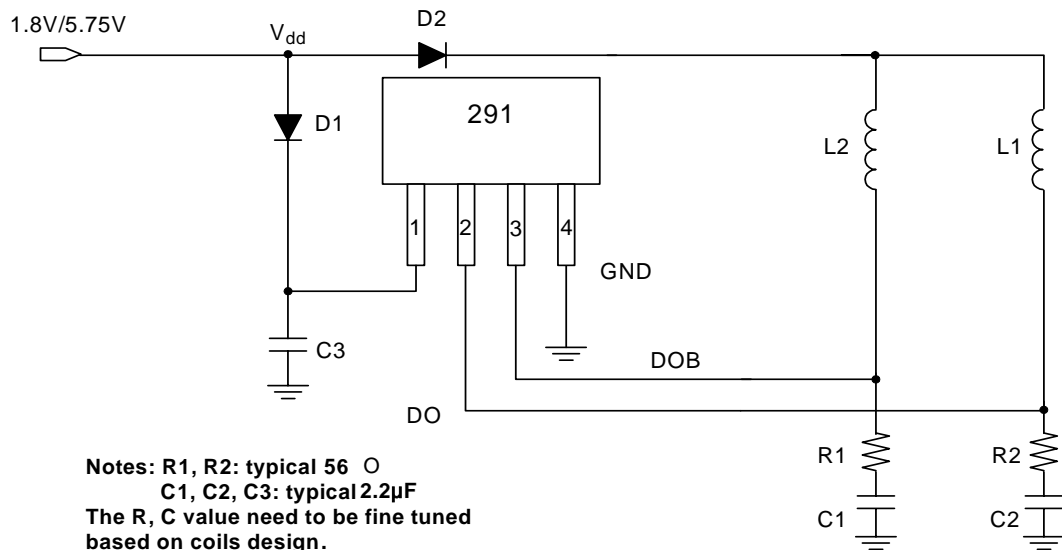

1.8V/5.75V Brush-Less DC Fan

Absolute Maximum Ratings ($T_A = 25^\circ\text{C}$)

Characteristics	Symbol	Rating	Unit	
Operating Supply Voltage	V_{dd}	8	V	
Output Current	$I_{O(AVE)}$	400	mA	
	$I_{O(PEAK)}$	700		
Power Dissipation	P_D	SIP-4L	550	mW
		SOT25	230	
		SOT89-5L	800	
Operating Temperature	T_{opr}	-20 ~ 100	$^\circ\text{C}$	
Storage Temperature	T_{stg}	-55 ~ 150	$^\circ\text{C}$	
Maximum Junction Temperature	T_j	150	$^\circ\text{C}$	

Electrical Characteristics ($T_A = 25^\circ\text{C}$, $V_{dd} = 5\text{V}$, unless otherwise specified)

Characteristics	Symbol	Conditions	Min.	Typ.	Max.	Unit
Supply Voltage	V_{dd}	Operating	1.8*	-	5.75	V
Supply Current	I_{dd}	Operating	-	2.6	4.0	mA
Lock Protection On	T_{lrp-on}		-	0.4	-	Sec
Lock Protection Off	$T_{lrp-off}$		2.4	3	3.6	Sec
Output Saturation Voltage	$V_{OUT(SAT)}$	$I_O = 180\text{mA}$	-	300	-	mV
		$I_O = 350\text{mA}$	-	600	-	
Output On Resistance	$R_{ds(on)}$		-	1.75	-	ohm
Output Zener-Breakdown Voltage	V_Z		-	15	-	V

*Note: 3. The output of IC will be switched after the supply voltage is over 1.8V, but the magnetic characteristics won't be normal until the supply is over 2.0V.

Truth Table

IN-	IN+	CT	OUT1	OUT2	Mode
H	L	L	H	L	Rotating
L	H	L	L	H	Rotating
-	-	H	off	off	Lockup protection activated

Magnetic Characteristics ($T_A = 25\text{ }^\circ\text{C}$, $V_{CC} = 24\text{V}$, unless otherwise specified)

(1mT = 10 Gauss)

Characteristics	Symbol	Min.	Typ.	Max.	Unit
Operation Point	Bop	--	30	60	Gauss
Release Point	Brp	-60	-30	--	Gauss
Hysteresis	Bhy	--	60	--	Gauss

Operating Characteristics

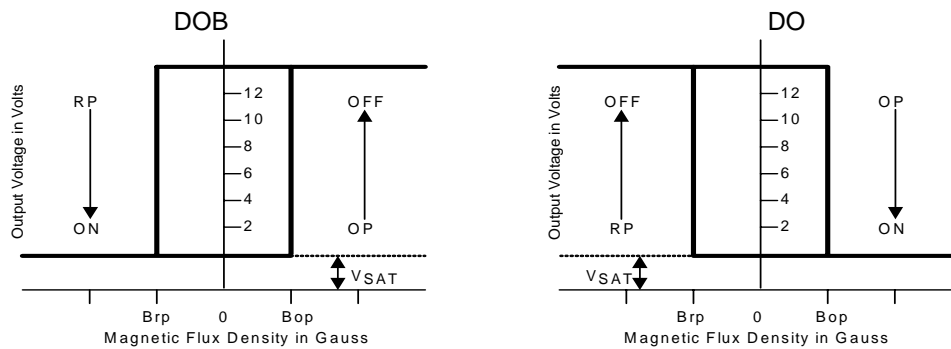

Performance Characteristics (SIP-4L)

T_a ($^\circ\text{C}$)	25	50	60	70	80	85	90	95	100
P_d (mW)	550	440	396	352	308	286	264	242	220
T_a ($^\circ\text{C}$)	105	110	115	120	125	130	135	140	150
P_d (mW)	198	176	154	132	110	88	66	44	0

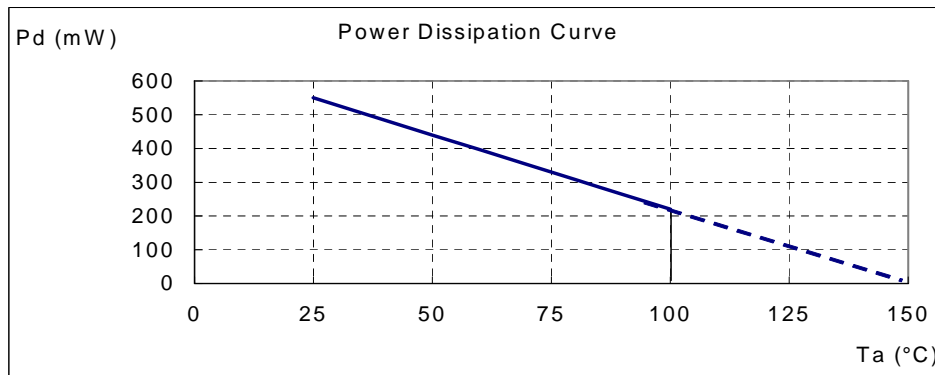

Performance Characteristics (SOT25)

T _a (°C)	25	50	60	70	80	90	100	110	120	130	140	150
P _d (mW)	230	184	166	147	129	110	92	74	55	37	18	0

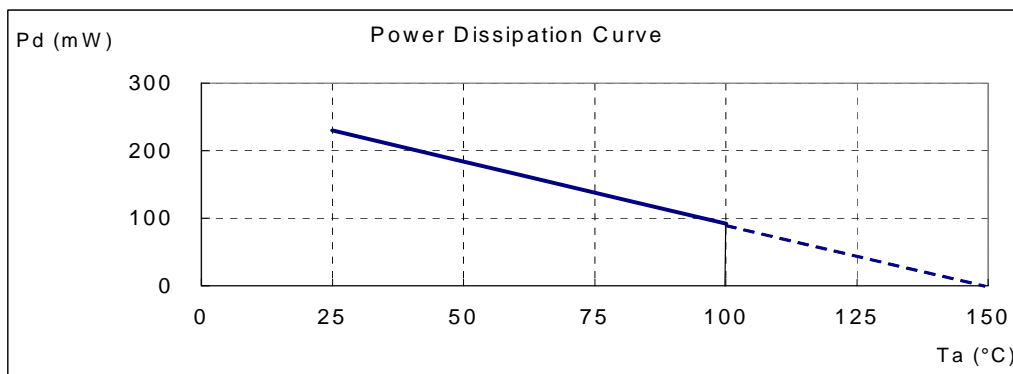

Performance Characteristics (SOT89-5L) (Continued)

T _d (°C)	25	50	60	70	75	80	85	90	95	100
P _d (mW)	800	640	576	512	480	448	416	384	352	320
T _d (°C)	105	110	115	120	125	130	135	140	145	150
P _d (mW)	288	256	224	192	160	128	96	64	32	0

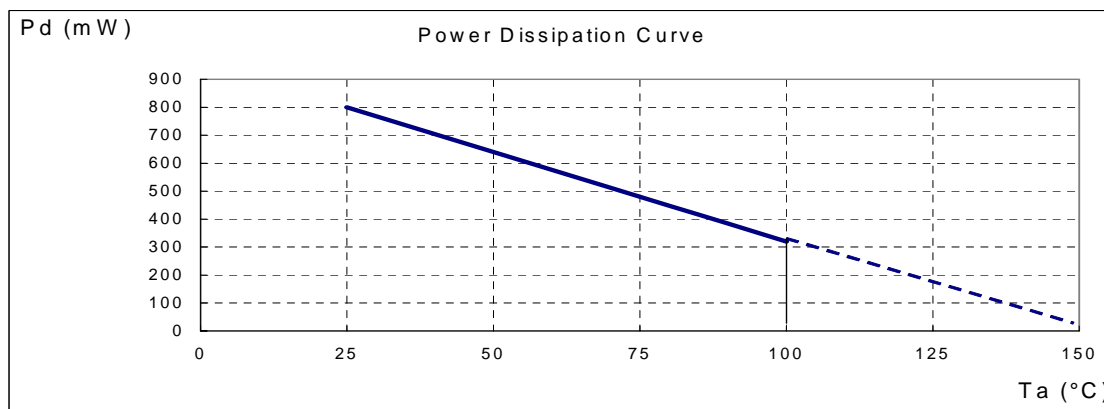

Marking Information

(1) SIP-4L

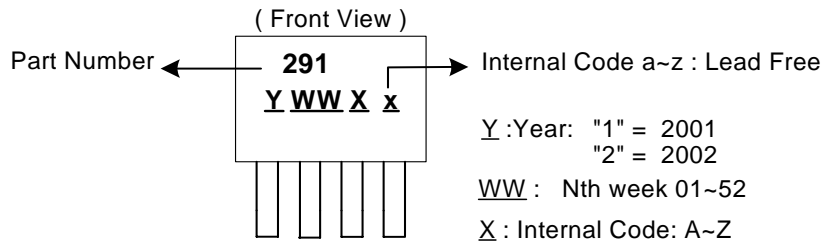

(2) SOT25

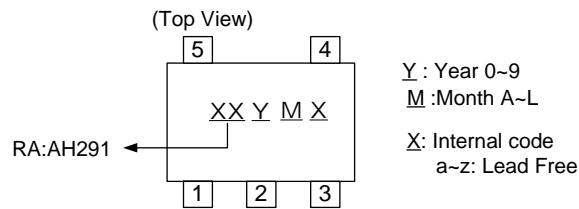

(3) SOT89-5L

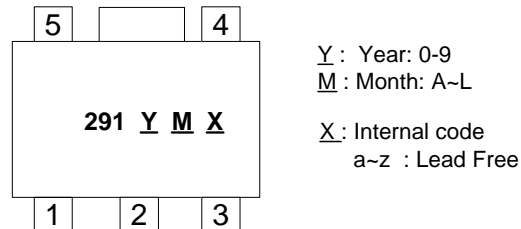

Package Information (unit: mm)

(1) SIP-4L

Active Area Depth

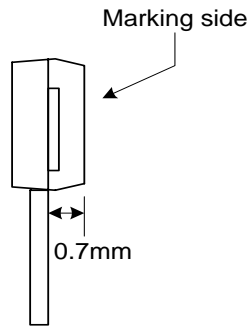

Package Sensor Location

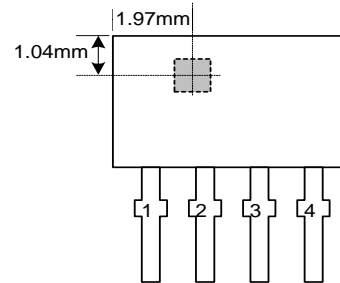

Package Dimension

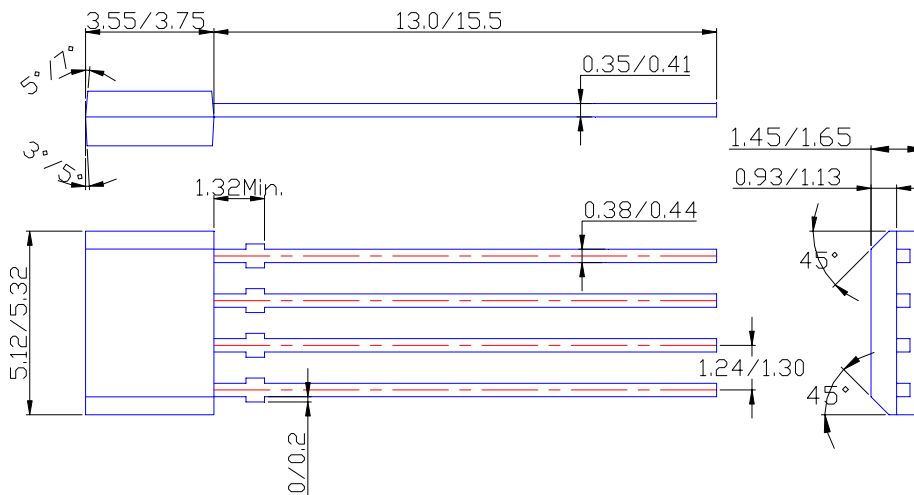

Package Information (Continued)

(2) SOT25

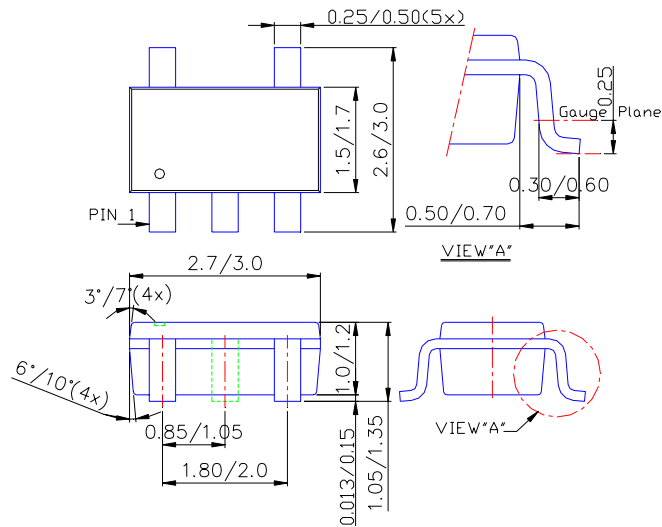

(3) SOT89-5L

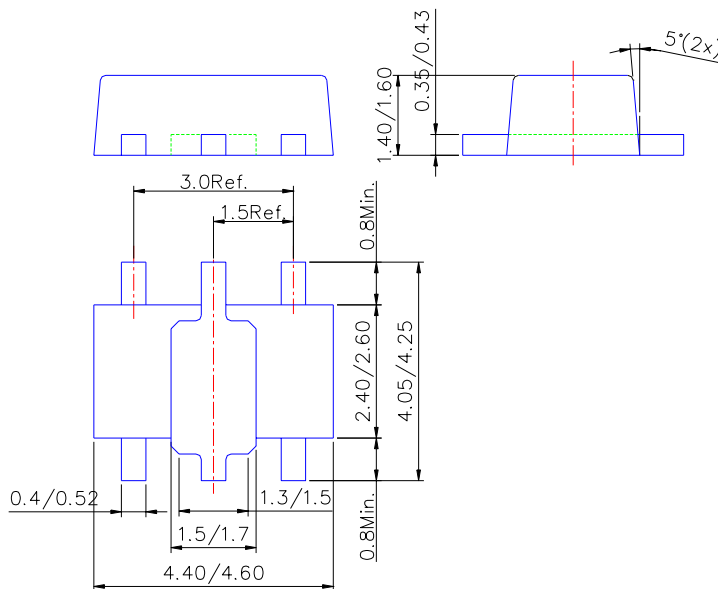

IMPORTANT NOTICE

Diodes Incorporated and its subsidiaries reserve the right to make modifications, enhancements, improvements, corrections or other changes without further notice to any product herein. Diodes Incorporated does not assume any liability arising out of the application or use of any product described herein; neither does it convey any license under its patent rights, nor the rights of others. The user of products in such applications shall assume all risks of such use and will agree to hold Diodes Incorporated and all the companies whose products are represented on our website, harmless against all damages.

LIFE SUPPORT

Diodes Incorporated products are not authorized for use as critical components in life support devices or systems without the expressed written approval of the President of Diodes Incorporated.