

DATA SHEET

Part No.	AN44066A
Package Code No.	SSOP032-P-0300B

Contents

■ Overview	3
■ Features	3
■ Applications	3
■ Package	3
■ Type	3
■ Application Circuit Example	4
■ Pin Descriptions	5
■ Absolute Maximum Ratings	6
■ Operating Supply Voltage Range	6
■ Allowable Current and Voltage Range	7
■ Electrical Characteristics	8
■ Electrical Characteristics (Reference values for design)	10
■ Technical Data	11
• I/O block circuit diagrams and pin function descriptions	11
• Control mode	16
• P_D — T_a diagram	21
■ Usage Notes	22
• Special attention and precaution in using	22
• Notes of Power LSI	23

AN44066A

Driver IC for Stepping Motor

■ Overview

AN44066A is a two channels H-bridge driver IC. Bipolar stepping motor can be controlled by this single driver IC. 2-phase, half-step, 1-2 phase, W1-2 phase can be selected.

■ Features

- 2-phase input control by rationalization of interface (2-phase excitation, half-step, and 1-2 phase excitation enabled)
- 4-phase input control (W1-2 phase excitation enabled)
- Built-in CR chopping (with frequency selected)
- Built-in standby function
- Built-in thermal protection and low voltage detection circuit
- Built-in 5 V power supply

■ Applications

- IC for stepping motor drives

■ Package

- 32 pin Plastic Shrink Small Outline Package (SSOP Type)

■ Type

- Bi-CDMOS IC

■ Application Circuit Example

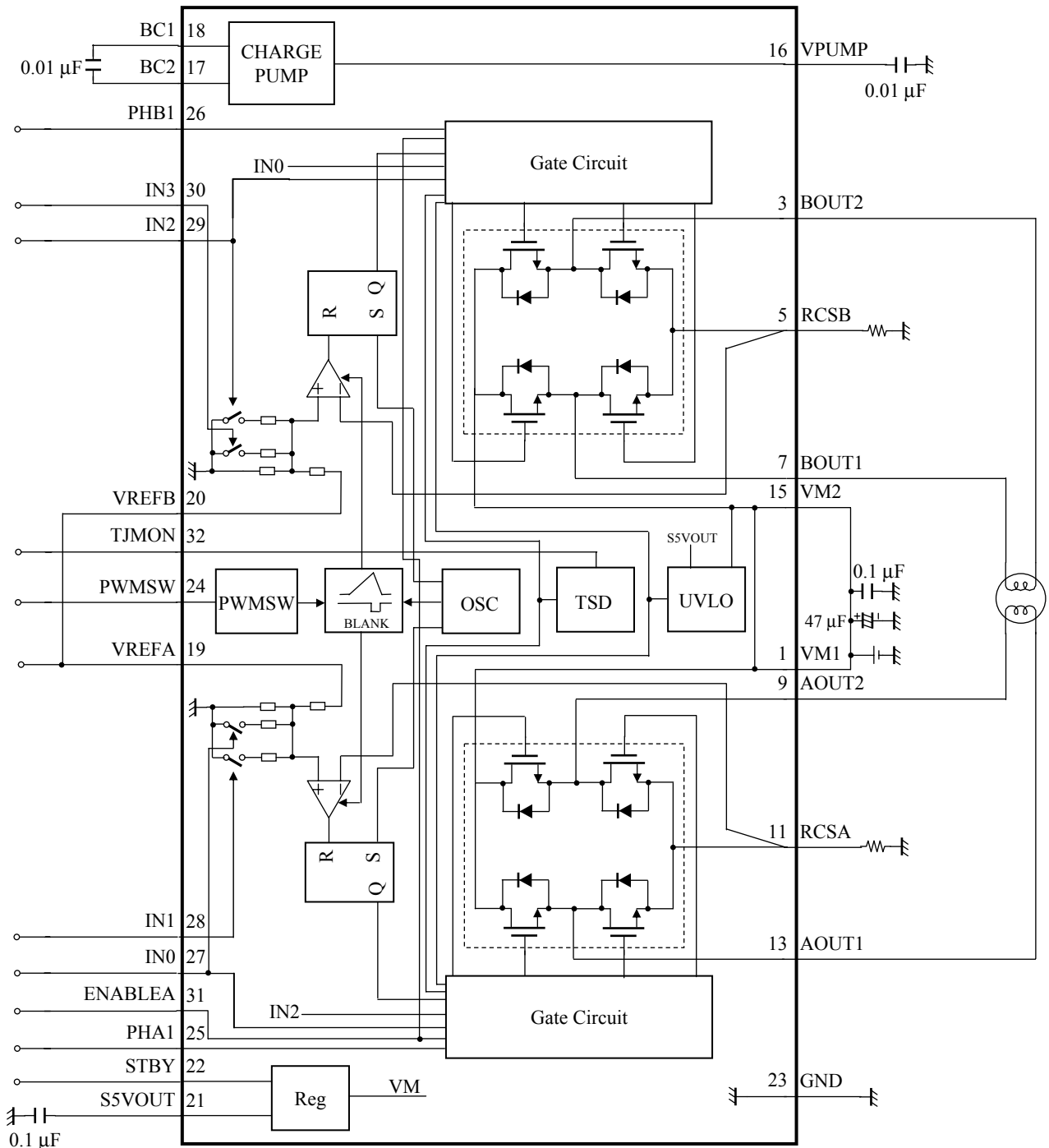

Note) • This application circuit is shown as an example but does not guarantee the design for mass production set.

■ Pin Descriptions

Pin No.	Pin name	Type	Description
1	VM1	Power supply	Motor power supply 1
2	N.C.	—	N.C.
3	BOUT2	Output	Phase B motor drive output 2
4	N.C.	—	N.C.
5	RCSB	Input / Output	Phase B current detection
6	N.C.	—	N.C.
7	BOUT1	Output	Phase B motor drive output 1
8	N.C.	—	N.C.
9	AOUT2	Output	Phase A motor drive output 2
10	N.C.	—	N.C.
11	RCSA	Input / Output	Phase A current detection
12	N.C.	—	N.C.
13	AOUT1	Output	Phase A motor drive output 1
14	N.C.	—	N.C.
15	VM2	Power supply	Motor power supply 2
16	VPUMP	Output	Charge Pump circuit output
17	BC2	Output	Charge Pump capacitor connection 2
18	BC1	Output	Charge Pump capacitor connection 1
19	VREFA	Input	Phase A torque reference voltage input
20	VREFB	Input	Phase B torque reference voltage input
21	S5VOUT	Output	Internal reference voltage (5 V output)
22	STBY	Input	Standby setting
23	GND	Ground	Signal ground
24	PWMSW	Input	PWM frequency selection input
25	PHA1	Input	Phase A phase selection input
26	PHB1	Input	Phase B phase selection input
27	IN0	Input	Phase A output torque control 1
28	IN1	Input	Phase A output torque control 2
29	IN2	Input	Phase B output torque control 1
30	IN3	Input	Phase B output torque control 2
31	ENABLEA	Input	Phase A/B start/stop signal input
32	TJMON	Output	VBE monitor

■ Absolute Maximum Ratings

Note) Absolute maximum ratings are limit values which are not destructed, and are not the values to which operation is guaranteed.

A No.	Parameter	Symbol	Rating	Unit	Note
1	Supply voltage (Pin 1, 15)	V_M	37	V	*1
2	Power dissipation	P_D	0.427	W	*2
3	Operating ambient temperature	T_{opr}	-20 to +70	°C	*3
4	Storage temperature	T_{stg}	-55 to +150	°C	*3
5	Output pin voltage (Pin 3, 7, 9, 13)	V_{OUT}	37	V	*4
6	Motor drive current (Pin 3, 7, 9, 13)	I_{OUT}	±0.8	A	*4
7	Flywheel diode current (Pin 3, 7, 9, 13)	I_f	0.8	A	*4

Notes) *1 : The values under the condition not exceeding the above absolute maximum ratings and the power dissipation.

*2 : The power dissipation shown is the value at $T_a = 70^\circ\text{C}$ for the independent (unmounted) IC package without a heat sink.

When using this IC, refer to the P_D - T_a diagram of the package standard and design the heat radiation with sufficient margin so that the allowable value might not be exceeded based on the conditions of power supply voltage, load, and ambient temperature.

*3 : Except for the power dissipation, operating ambient temperature, and storage temperature, all ratings are for $T_a = 25^\circ\text{C}$.

*4 : Do not apply external currents or voltages to any pin not specifically mentioned.

For the circuit currents, "+" denotes current flowing into the IC, and "-" denotes current flowing out of the IC.

■ Operating Supply Voltage Range

Parameter	Symbol	Range	Unit	Note
Operating supply voltage range	V_M	10.0 to 34.0	V	*

Note) *: The values under the condition not exceeding the above absolute maximum ratings and the power dissipation.

■ Allowed Voltage and Current Ranges

Notes) • Rating Voltage is voltage of pin on GND

- Do not apply current or voltage from outside to any pin not listed above.
- For the circuit currents, "+" denotes current flowing into the IC, and "-" denotes current flowing out of the IC.

Pin No.	Pin name	Rating	Unit	Note
5	RCSB	2.5	V	—
11	RCSA	2.5	V	—
16	VPUMP	$(V_M - 1)$ to 43	V	*1
17	BC2	$(V_M - 1)$ to 43	V	*1
18	BC1	$V_M + 0.3$	V	*1
19	VREFA	-0.3 to 6	V	—
20	VREFB	-0.3 to 6	V	—
22	STBY	-0.3 to 6	V	—
24	PWMSW	-0.3 to 6	V	—
25	PHA1	-0.3 to 6	V	—
26	PHB1	-0.3 to 6	V	—
27	IN0	-0.3 to 6	V	—
28	IN1	-0.3 to 6	V	—
29	IN2	-0.3 to 6	V	—
30	IN3	-0.3 to 6	V	—
31	ENABLEA	-0.3 to 6	V	—

Pin No.	Pin name	Rating	Unit	Note
21	S5VOUT	-5 to 0	mA	*1 *2

Notes) *1 : Do not apply external voltages to this pin. Set not to exceed allowable range at any time.

*2 : This is the rating under the condition that V_M is used in the range between 16 V and 34 V. When V_M is used in the range between 10 V and 16 V, the rating is -1.4 mA to 0.

■ Electrical Characteristics at $V_M = 24\text{ V}$

Note) $T_a = 25^\circ\text{C} \pm 2^\circ\text{C}$ unless otherwise specified.

B No.	Parameter	Symbol	Conditions	Limits			Unit	Note
				Min	Typ	Max		
Power Block								
1	High-level output saturation voltage	V_{OH}	$I_{IN} = -0.5\text{ A}$	$V_M - 0.47$	$V_M - 0.31$	—	V	—
2	Low-level output saturation voltage	V_{OL}	$I_{IN} = 0.5\text{ A}$	—	0.47	0.71	V	—
3	Flywheel diode forward voltage	V_{DI}	$I_{IN} = \pm 0.5\text{ A}$	0.5	1.0	1.5	V	—
4	Output leakage current	I_{LEAK}	$V_M = 37\text{ V}, V_{RCS} = 0\text{ V}$	—	10	20	μA	—
5	Supply current (at when only control system and charge Pump circuit are ON)	I_M	ENABLEA = 3.3 V STBY = 0 V	—	5.4	8.2	mA	—
6	Supply current (at standby mode)	I_{STBY}	STBY = 2.1 V	—	120	190	μA	—
I/O Block								
7	High-level IN input voltage	V_{INH}		2.2	—	5.5	V	—
8	Low-level IN input voltage	V_{INL}		0	—	0.6	V	—
9	High-level IN input current	I_{INH}	IN0 = IN1 = IN2 = IN3 = 5 V	-10	—	10	μA	—
10	Low-level IN input current	I_{INL}	IN0 = IN1 = IN2 = IN3 = 0 V	-15	—	15	μA	—
11	High-level PHA1/PHB1 input voltage	V_{PHAH} V_{PHBH}		2.2	—	5.5	V	—
12	Low-level PHA1/PHB1 input voltage	V_{PHAL} V_{PHBL}		0	—	0.6	V	—
13	High-level PHA1/PHB1 input current	I_{PHAH} I_{PHBH}	PHA1 = PHB1 = 3.3 V	16.5	33	66	μA	—
14	Low-level PHA1/PHB1 input current	I_{PHAL} I_{PHBL}	PHA1 = PHB1 = 0 V	-15	—	15	μA	—
15	High-level ENABLEA input voltage	$V_{ENABLEAH}$		2.2	—	5.5	V	—
16	Low-level ENABLEA input voltage	$V_{ENABLEAL}$		0	—	0.6	V	—
17	High-level ENABLEA input current	$I_{ENABLEAH}$	ENABLEA = 5 V	-10	—	10	μA	—
18	Low-level ENABLEA input current	$I_{ENABLEAL}$	ENABLEA = 0 V	-15	—	15	μA	—
19	High-level PWMSW input voltage	V_{PWMSWH}		2.2	—	5.5	V	—
20	Low-level PWMSW input voltage	V_{PWMSWL}		0	—	0.6	V	—
21	High-level PWMSW input current	I_{PWMSWH}	PWMSW = 3.3 V	8	16.5	33	μA	—
22	Low-level PWMSW input current	I_{PWMSWL}	PWMSW = 0 V	-15	—	15	μA	—
23	High-level STBY input voltage	V_{STBYH}		2.1	—	5.5	V	—
24	Low-level STBY input voltage	V_{STBYL}		0	—	0.6	V	—
25	High-level STBY input current	I_{STBYH}	STBY = 5 V	—	30	45	μA	—
26	Low-level STBY input current	I_{STBYL}	STBY = 0 V	-2	—	2	μA	—

■ Electrical Characteristics (continued) at $V_M = 24\text{ V}$

Note) $T_a = 25^\circ\text{C} \pm 2^\circ\text{C}$ unless otherwise specified.

B No.	Parameter	Symbol	Conditions	Limits			Unit	Note
				Min	Typ	Max		
Torque Control Block								
27	Input bias current	I_{REFA} I_{REFB}	$V_{\text{REFA}} = 5\text{ V}$ $V_{\text{REFB}} = 5\text{ V}$	83.3	100	125	μA	—
28	PWM frequency1	f_{PWM1}	$\text{PWMSW} = 0.6\text{ V}$	34	52	70	kHz	—
29	PWM frequency2	f_{PWM2}	$\text{PWMSW} = 2.2\text{ V}$	17	26	35	kHz	—
30	Pulse blanking time	T_B	$V_{\text{REFA}} = V_{\text{REFB}} = 0\text{ V}$	0.38	0.75	1.12	μs	—
31	Comp threshold H (100%)	VT_H	$V_{\text{REFA}} = V_{\text{REFB}} = 3.3\text{ V}$ $IN0 = IN1 = 0.6\text{ V}$ $IN2 = IN3 = 0.6\text{ V}$	627	660	693	mV	—
32	Comp threshold C (67%)	VT_C	$V_{\text{REFA}} = V_{\text{REFB}} = 3.3\text{ V}$ $IN0 = 2.2\text{ V}, IN1 = 0.6\text{ V}$ $IN2 = 2.2\text{ V}, IN3 = 0.6\text{ V}$	410	440	470	mV	—
33	Comp threshold L (33%)	VT_L	$V_{\text{REFA}} = V_{\text{REFB}} = 3.3\text{ V}$ $IN0 = 0.6\text{ V}, IN1 = 2.2\text{ V}$ $IN2 = 0.6\text{ V}, IN3 = 2.2\text{ V}$	200	220	240	mV	—
Reference Voltage Block								
34	Reference voltage	V_{SSVOUT}	$I_{\text{SSVOUT}} = 0\text{ mA}$	4.5	5.0	5.5	V	—
35	Output impedance	Z_{SSVOUT}	$I_{\text{SSVOUT}} = -1.5\text{ mA}, -3.5\text{ mA}$	—	18	27	Ω	—

■ Electrical Characteristics (Reference values for design) at $V_M = 24\text{ V}$

Notes) $T_a = 25^\circ\text{C} \pm 2^\circ\text{C}$ unless otherwise specified.

The characteristics listed below are reference values derived from the design of the IC and are not guaranteed by inspection.

If a problem does occur related to these characteristics, we will respond in good faith to user concerns.

B No.	Parameter	Symbol	Conditions	Reference values			Unit	Note
				Min	Typ	Max		
Output Drivers								
36	Output slew rate 1	VT_r	Output voltage rising edge	—	270	—	V/ μs	—
37	Output slew rate 2	VT_f	Output voltage falling edge	—	330	—	V/ μs	—
38	Dead time	T_D		—	2.8	—	μs	—
Thermal Protection								
39	Thermal protection operating temperature	TSD_{on}		—	150	—	$^\circ\text{C}$	—
40	Thermal protection hysteresis width	ΔTSD		—	40	—	$^\circ\text{C}$	—
VREF Block								
41	Input impedance	Z_{VREFA} Z_{VREFB}	$V_{REFA} = 5\text{ V}$ $V_{REFB} = 5\text{ V}$	40	50	60	k Ω	—
42	Input impedance precision	—		-20	—	20	%	—
I/O Block								
43	High-level PHA1/PHB1 input current 2	I_{PHAH2} I_{PHBH2}	PHA1 = PHB1 = 5 V	—	68	—	μA	*1
44	High-level PWMSW input current 2	$I_{PWMSWH2}$	PWMSW = 5 V	—	42	—	μA	*1

Note) *1 : Refer to the “Usage Notes” (P.35) for the input current characteristics about PHA1, PHB1, PWMSW.

■ Technical Data

- Circuit diagrams of the input/output part and pin function descriptions

Note) The characteristics listed below are reference values based on the IC design and are not guaranteed.

Pin No.	Waveform and voltage	Internal circuit	Impedance	Description
3 5 7 9 11 13	—		—	Pin3 : Phase B motor drive output 2 5 : Phase B current detection 7 : Phase B motor drive output 1 9 : Phase A motor drive output 2 11 : Phase A current detection 13 : Phase A motor drive output 1
16 17	—		—	Pin16 : Charge Pump circuit output 17 : Charge Pump capacitor connection 2

■ Technical Data (continued)

- Circuit diagrams of the input/output part and pin function descriptions (continued)

Note) The characteristics listed below are reference values based on the IC design and are not guaranteed.

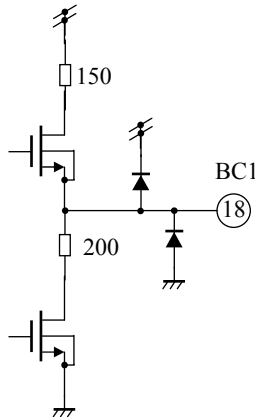
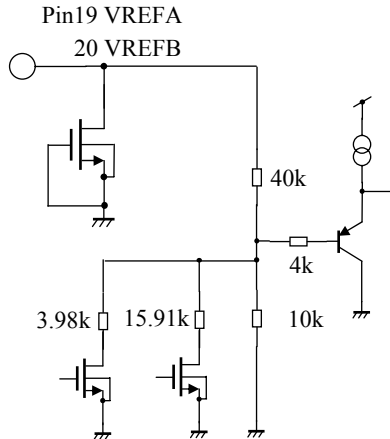
Pin No.	Waveform and voltage	Internal circuit	Impedance	Description
18	—		—	Pin18 : Charge Pump capacitor connection 1
19 20	—		50 kΩ	Pin19 : Phase A torque reference voltage input 20 : Phase B torque reference voltage input

■ Technical Data (continued)

- Circuit diagrams of the input/output part and pin function descriptions (continued)

Note) The characteristics listed below are reference values based on the IC design and are not guaranteed.

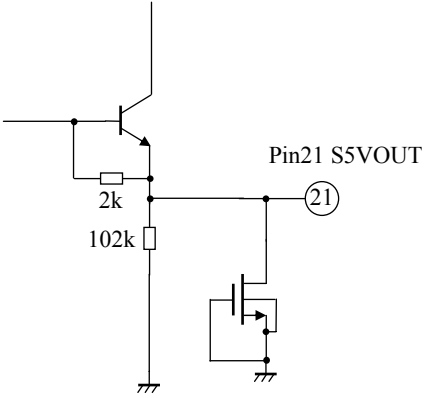
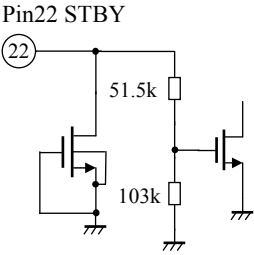
Pin No.	Waveform and voltage	Internal circuit	Impedance	Description
21	—	 <p>Pin21 S5VOUT</p>	—	Pin21 : Internal reference voltage (5 V output)
22	—	 <p>Pin22 STBY</p>	154.5 kΩ	Pin22 : Standby setting

■ Technical Data (continued)

- Circuit diagrams of the input/output part and pin function descriptions (continued)

Note) The characteristics listed below are reference values based on the IC design and are not guaranteed.

Pin No.	Waveform and voltage	Internal circuit	Impedance	Description
24	—		200 kΩ	Pin24 : PWM frequency selection input
25 26	—		100 kΩ	Pin25 : Phase A phase selection input 26 : Phase B phase selection input

■ Technical Data (continued)

• Circuit diagrams of the input/output part and pin function descriptions (continued)

Note) The characteristics listed below are reference values based on the IC design and are not guaranteed.

Pin No.	Waveform and voltage	Internal circuit	Impedance	Description
27 28 29 30 31	—	<p>Pin27 IN0 28 IN1 29 IN2 30 IN3 31 ENABLEA</p>	—	Pin27 : Phase A output torque control 1 28 : Phase A output torque control 2 29 : Phase B output torque control 1 30 : Phase B output torque control 2 31 : Phase A/B start/stop signal input
32	—	<p>Pin32 TJMON</p>	—	Pin32 : VBE monitor
Symbols	—	<p> \uparrow S5VOUT (Pin21) \uparrow VM(Pin1, Pin15) \uparrow Diode \uparrow Zener diode \uparrow Ground </p>	—	—

■ Technical Data

• Control mode

1. Truth table

1) Control/Charge pump circuit

STBY	ENABLE	Control/Charge pump circuit	Output transistor
High	—	OFF	OFF
Low	High	ON	OFF
Low	Low	ON	ON

2) Output polarity

ENABLEA	PHA1/PHB1	AOUT1/BOU1	AOUT2/BOU2
Low	High	High	Low
Low	Low	Low	High
High	—	OFF	OFF

3) Output current of 2-phase excitation / half step / 1-2 phase excitation

IN0	IN2	A-ch. Output Current	B-ch. Output Current
Low	Low	$(VREF / 5) \times (1 / Rs)$	$(VREF / 5) \times (1 / Rs)$
High	Low	0	$(VREF / 5) \times (1 / Rs)$
Low	High	$(VREF / 5) \times (1 / Rs)$	0
High	High	$(VREF / 5) \times (1 / Rs) \times (2 / 3)$	$(VREF / 5) \times (1 / Rs) \times (2 / 3)$

Notes) Rs : current detection region
IN1 = IN3 = Low level

4) Output current of W1-2 phase excitation

A-ch. output

IN0	IN2	IN1	A-ch. Output Current
Low	Low	Low	$(VREF / 5) \times (1 / Rs)$
Low	Low	High	$(VREF / 5) \times (1 / Rs) \times (1 / 3)$
High	Low	Don't care	0
Low	High	Low	$(VREF / 5) \times (1 / Rs)$
High	High	Low	$(VREF / 5) \times (1 / Rs) \times (2 / 3)$

Note) Rs : current detection region

B-ch. output

IN0	IN2	IN3	B-ch. Output Current
Low	Low	Low	$(VREF / 5) \times (1 / Rs)$
Low	Low	High	$(VREF / 5) \times (1 / Rs) \times (1 / 3)$
High	Low	Low	$(VREF / 5) \times (1 / Rs)$
Low	High	Don't care	0
High	High	Low	$(VREF / 5) \times (1 / Rs) \times (2 / 3)$

Note) Rs : current detection region

■ Technical Data (continued)

- Control mode (continued)

2. Output wave

- 1) Drive of 2-phase excitation (4steps sequence)
(IN0 to IN3 = Low)

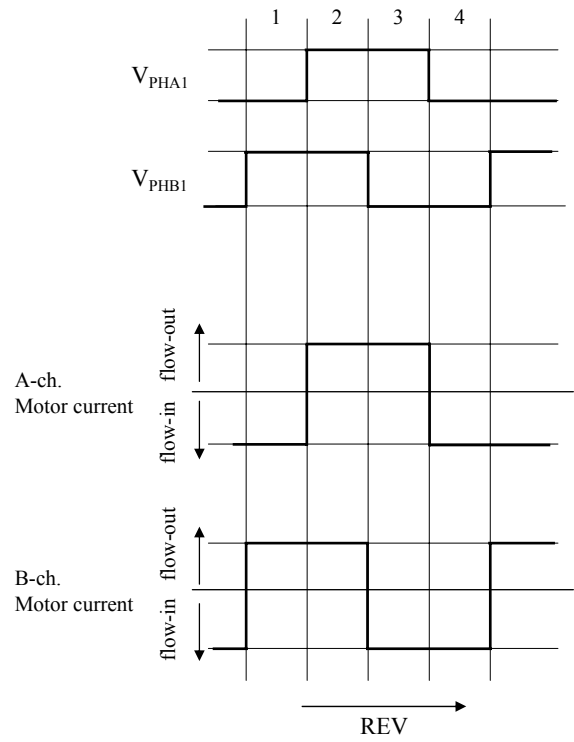
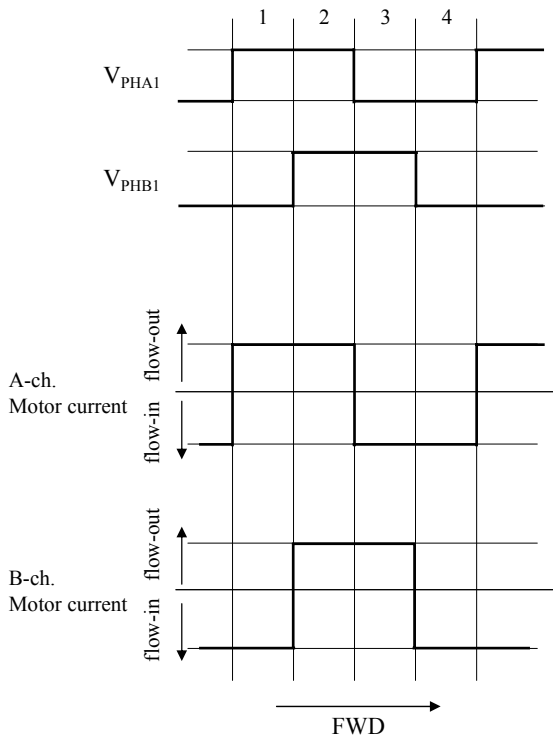

■ Technical Data (continued)

- Control mode (continued)

2. Output wave (continued)

- 2) Drive of half step (8-steps sequence)
(IN1 = IN3 = Low)

(Ex.)

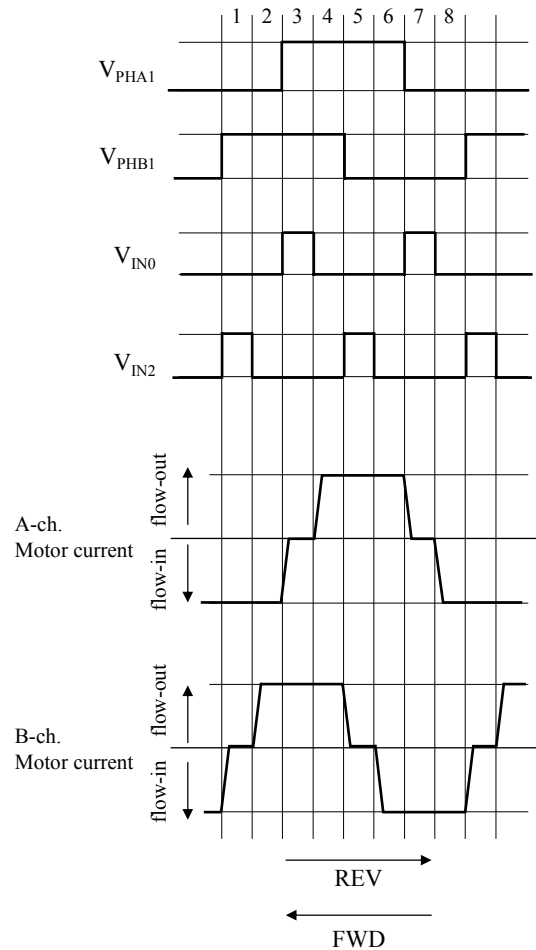
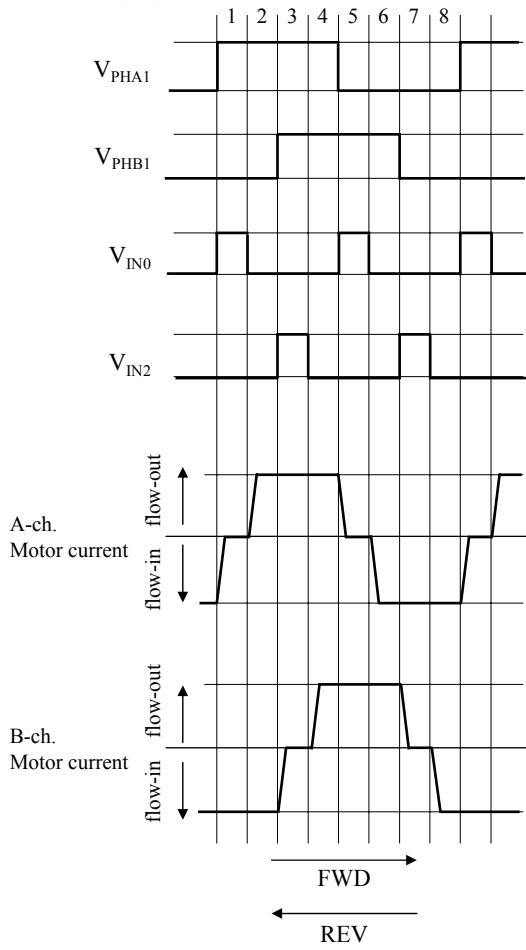

■ Technical Data (continued)

- Control mode (continued)

2. Output wave (continued)

- 3) Drive of 1-2 phase excitation (8-steps sequence)
(IN1 = IN3 = Low)

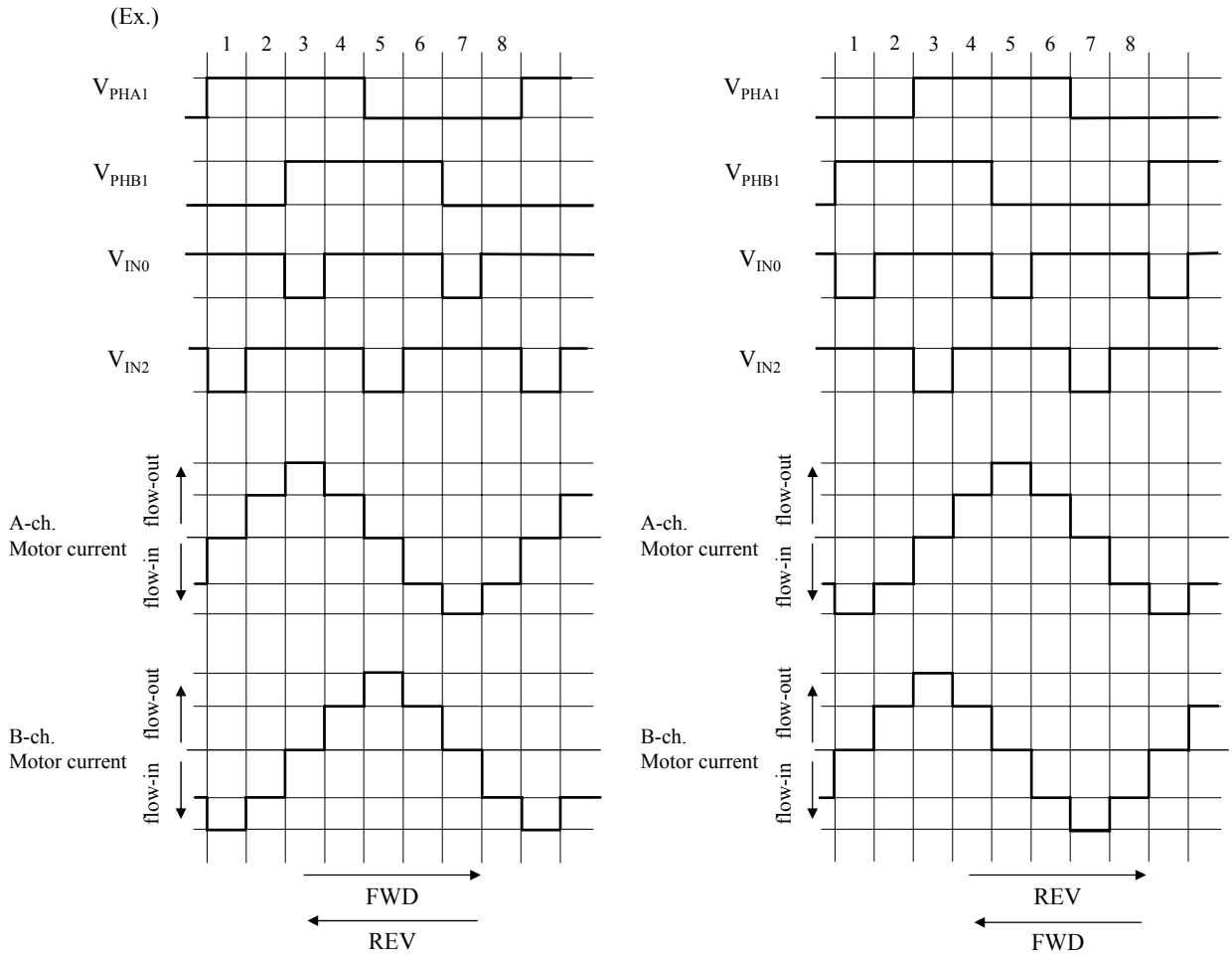

■ Technical Data (continued)

- Control mode (continued)

2. Output wave (continued)

4) Drive of W1-2 phase excitation (16-steps sequence)

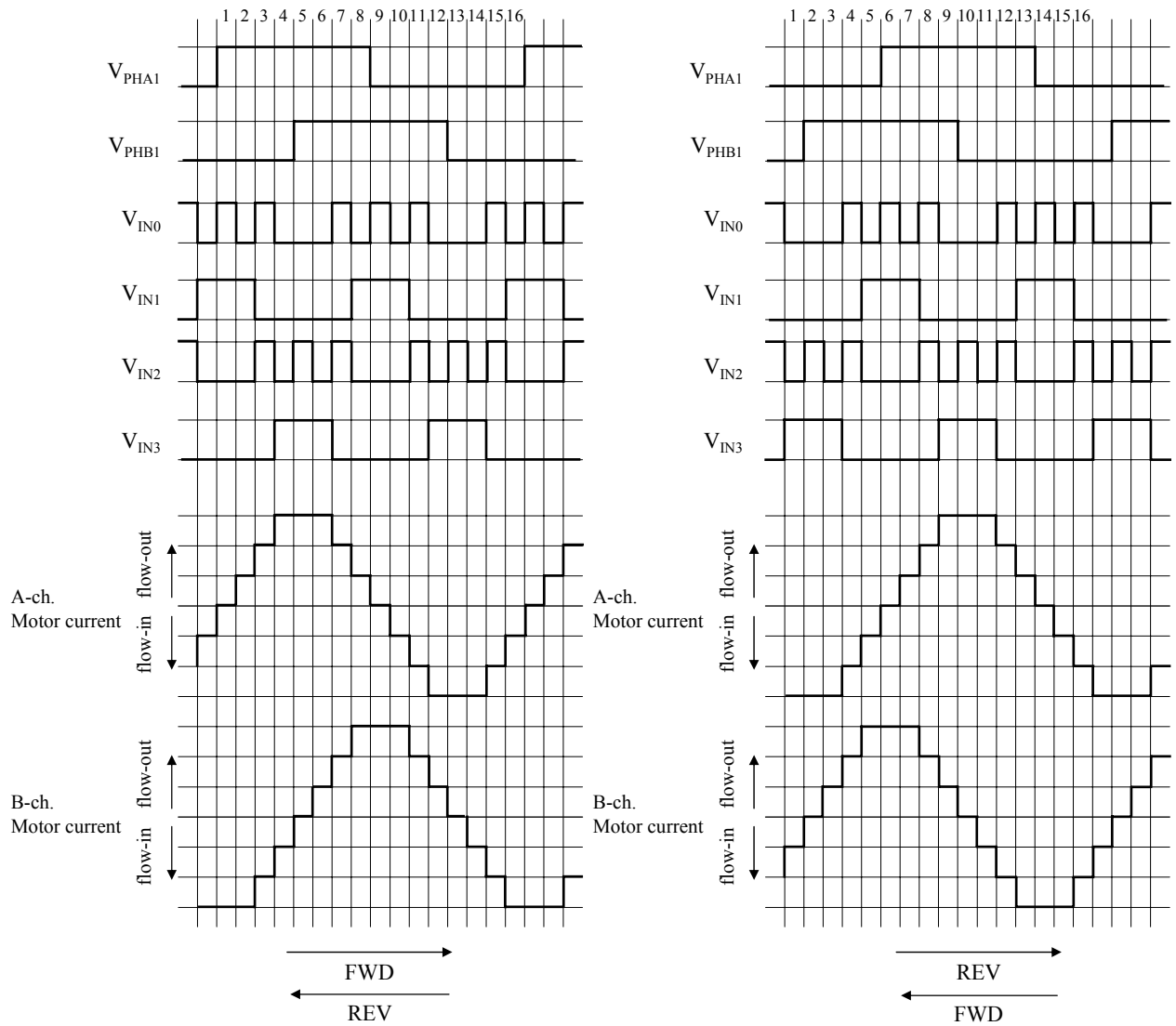

■ Technical Data (continued)

- $P_D - T_a$ diagram

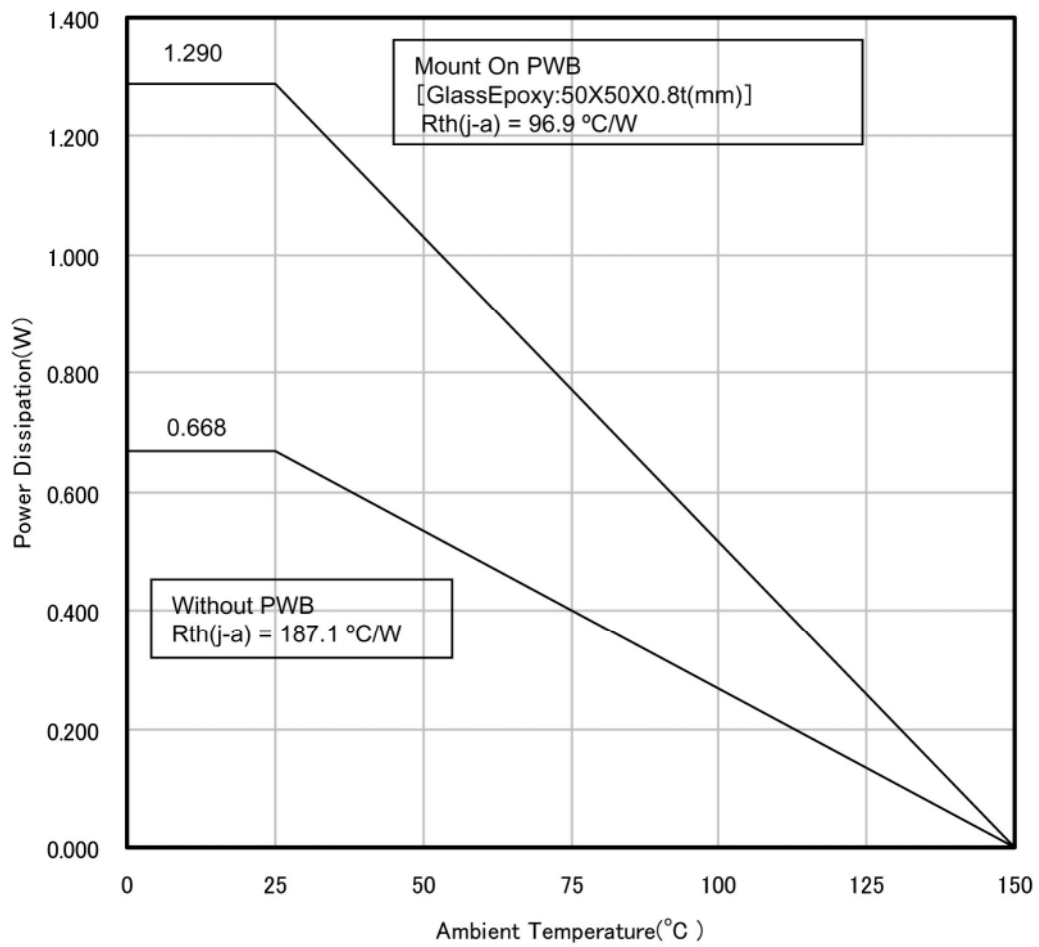

■ Usage Notes

• Special attention and precaution in using

1. This IC is intended to be used for general electronic equipment and driving stepping motor.
Consult our sales staff in advance for information on the following applications:
 - Special applications in which exceptional quality and reliability are required, or if the failure or malfunction of this IC may directly jeopardize life or harm the human body.
 - Any applications other than the standard applications intended.
 - (1) Space appliance (such as artificial satellite, and rocket)
 - (2) Traffic control equipment (such as for automobile, airplane, train, and ship)
 - (3) Medical equipment for life support
 - (4) Submarine transponder
 - (5) Control equipment for power plant
 - (6) Disaster prevention and security device
 - (7) Weapon
 - (8) Others : Applications of which reliability equivalent to (1) to (7) is required
2. Pay attention to the direction of LSI. When mounting it in the wrong direction onto the PCB (printed-circuit-board), it might smoke or ignite.
3. Pay attention in the PCB (printed-circuit-board) pattern layout in order to prevent damage due to short circuit between pins. In addition, refer to the Pin Description for the pin configuration.
4. Perform a visual inspection on the PCB before applying power, otherwise damage might happen due to problems such as a solder-bridge between the pins of the semiconductor device. Also, perform a full technical verification on the assembly quality, because the same damage possibly can happen due to conductive substances, such as solder ball, that adhere to the LSI during transportation.
5. Take notice in the use of this product that it might break or occasionally smoke when an abnormal state occurs such as output pin- V_M short (Power supply fault), output pin-GND short (Ground fault), or output-to-output-pin short (load short) .
And, safety measures such as an installation of fuses are recommended because the extent of the above-mentioned damage and smoke emission will depend on the current capability of the power supply.
Pay special attention to the following pins so that they are not short-circuited with the VM pin, ground pin, other output pin, or current detection pin.
 - (1) AOUT1 (Pin 13), AOUT2 (Pin 9), BOUT1 (Pin 7), BOUT2 (Pin 3)
 - (2) BC2 (Pin 17), VPUMP (Pin 16)
 - (3) VM1 (Pin 1), VM2 (Pin 15), S5VOUT(Pin 21)
 - (4) RCSA (Pin 11), RCSB (Pin 5)

The higher the current capacity of power supply is, the higher the possibility of the above destruction or smoke generation.
Therefore, it is recommended to take safety countermeasures, such as the use of a fuse.
6. When using the LSI for new models, verify the safety including the long-term reliability for each product.
7. When the application system is designed by using this LSI, be sure to confirm notes in this book.
Be sure to read the notes to descriptions and the usage notes in the book.

■ Usage Notes (continued)

• Notes of Power LSI

1. Perform thermal design work with consideration of a sufficient margin to keep the power dissipation based on supply voltage, load, and ambient temperature conditions.
(The IC is recommended that junctions are designed below 70% to 80% of Absolute Maximum Rating.)
2. The protection circuit is incorporated for the purpose of securing safety if the IC malfunctions.
Therefore, design the protection circuit so that the protection circuit will not operate under normal operating conditions. The temperature protection circuit, in particular, may be destructed before the temperature protection circuit operates if the area of safety operation of the device or the maximum rating is exceeded instantaneously due to the short-circuiting between the output pin and VM pin or a ground fault caused by the output pin and ground pin.
3. Unless specified in the product specifications, make sure that negative voltage or excessive voltage are not applied to the pins because the device might be damaged, which could happen due to negative voltage or excessive voltage generated during the ON and OFF timing when the inductive load of a motor coil or actuator coils of optical pick-up is being driven.
4. The product which has specified ASO (Area of Safe Operation) should be operated in ASO.
5. Verify the risks which might be caused by the malfunctions of external components.
6. Set the value of the capacitor between the VPUMP and GND pins so that the voltage on the VPUMP (Pin 16) will not exceed 43 V in any case regardless of whether it is a transient phenomenon or not while the motor standing by is started.
7. This IC employs a PWM drive method that switches the high-current output of the output transistor. Therefore, the IC is apt to generate noise that may cause the IC to malfunction or have fatal damage. To prevent these problems, the power supply must be stable enough. Therefore, the capacitance between the S5VOUT and GND pins must be 0.1 μ F and the one for power supply stabilization between the VM and GND pins must be a minimum of 47 μ F (recommendation) and as close as possible to the IC so that PWM noise will not cause the IC to malfunction or have fatal damage.

■ Usage Notes (continued)

8. Pulse blanking time

In order to prevent mistakes in current detection resulting noise, this IC is provided with a pulse blanking time of 0.75 μs (typ.). The motor current will not be less than the current determined by the pulse blanking time. Pay utmost attention at the time of minute current control.

Fig.1 shows the relationship between the pulse blanking time and minimum current value.

The increase or decrease in the motor current is determined by a load and a resistance of a internal winding in the motor, induced voltage, and PWM on-duty.

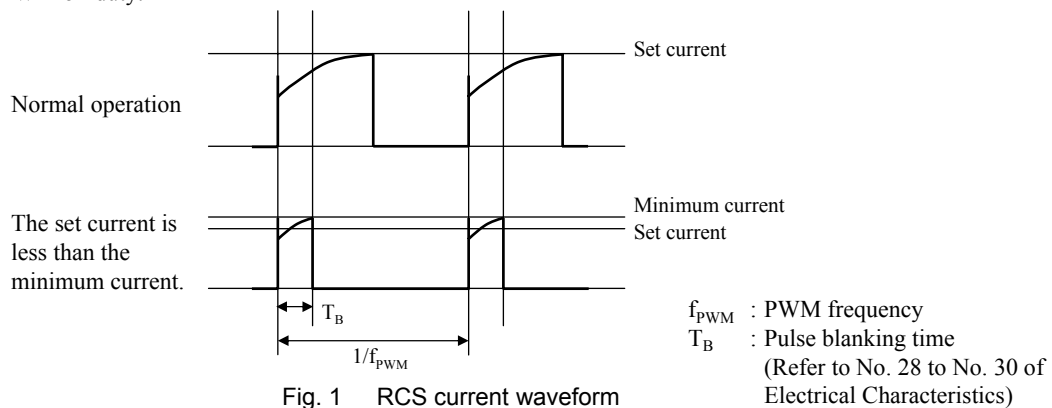

9. VREF voltage

When VREF voltage is set to lower, an error detection of motor current might be caused by noise because Comp threshold voltage (No.31, 32, 33 in the “Electrical Characteristics” / P.10) becomes low. Use this IC after confirming there is no error detection when VREF voltage is less than the set value.

10. Notes on the interface

Absolute maximum ratings of Pin 19, 20, 22 and Pin 24 to Pin31 are -0.3 V to 6 V . When the current setting for a motor is large and the lead line of GND is long, the potential of GND in this LSI will rise. Take notice that there is a possibility that potential of the interface pin is negative compared with that of GND in this LSI even if 0 V is applied to the interface pin. At that time, pay attention so that the input voltage of these pins might not exceed the values which are set in the allowable voltage range.

■ Usage Notes (continued)

11. Notes at the clear of standby mode / the rise of VM supply

In this LSI, all phases are forced OFF for about 300 μ s (typ.) after the clear of standby mode or the rise of VM supply. (See the following figure.) This is why the operation mode can be started after the charge pump circuit voltage boosts efficiently at shift to operation mode from standby mode / VM supply = OFF, when the charge pump operation stops. Therefore, the excitation patterns input after the forced all phase OFF period are effect.

When the charge pump circuit rises slowly owing to that the capacitance value between VPUMP-GND is made large etc. and the booster voltage cannot rise efficiently for the forced all phase OFF, the IC might overheat. In this case, clear the standby mode at ENABLE = High or restart after VM supply is turned ON, the booster voltage rises efficiently, and ENABLE is shifted to Low. The thermal protection is same operation as that at VM supply OFF.

[In case that standby mode is cleared]

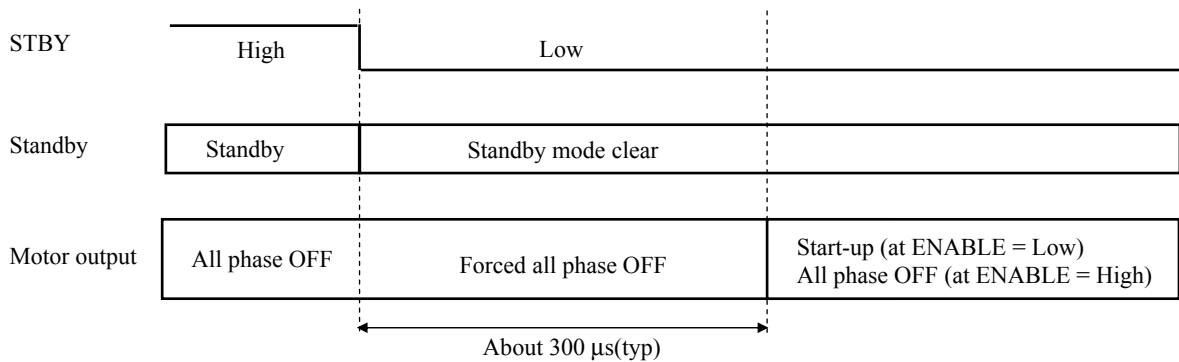

[In case that VM supply rises]

After VM supply exceeds threshold VM = 8.8 V(typ), all phases are forced OFF for about 300 μ s(typ).

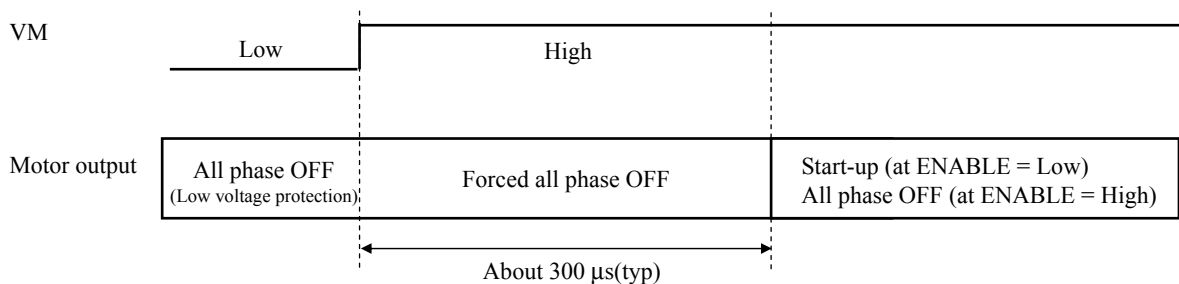

■ Usage Notes (continued)

12. PWMSW, PHA1, PHB1 pins

Under conditions where VM power supply is shutdown in standby mode (STBY pin = High level), when applying approx. 0.7 V (TYP) or more to PWMSW (Pin 24), PHA1 (Pin 25), PHB1 (Pin 26), the current flows into above-mentioned pins owing to parasitic elements in the LSI and the current flowing into the above-mentioned pins varies from the current determined by pull down resistance. In addition, the current flowing into PHA1/PHA2 is 341.4 μ A (impedance = approx. 9.1 k Ω) at 3.3 V, while that into PWMSW is 323.2 μ A (impedance = approx. 9.7 k Ω) at 3.3 V. There is no problem that the voltage up to rating is applied to the above-mentioned pins. However, it is recommended to set the voltage applied to the above-mentioned to 0.7 V or less at shutdown of VM power supply in standby mode.

Also, in case of the voltage of above-mentioned pins > S5VOUT(Pin 21) – 0.2 V at power on to VM power supply, the current flows owing to parasitic elements in the LSI, and the current flowing into the above-mentioned pins varies (refer to Fig. 2, 3). As the same as at standby, there is no problem that the voltage up to rating is applied to the above-mentioned pins. However, it is recommended to set the voltage applied to the above-mentioned pins to 4.3 V or less.

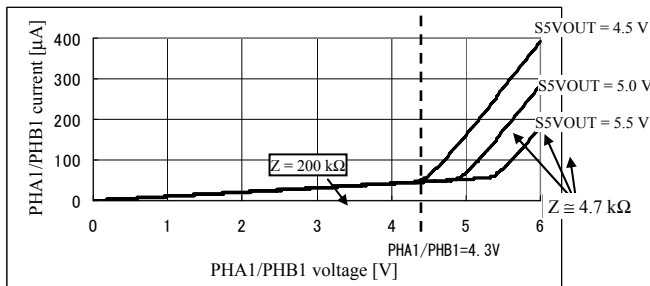

Fig. 2 Input impedance of PHA1/PHB1 at VM power supply power on

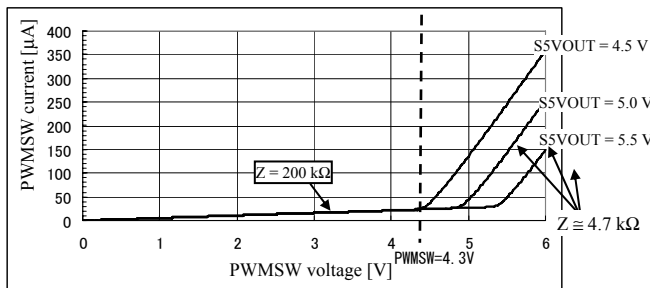
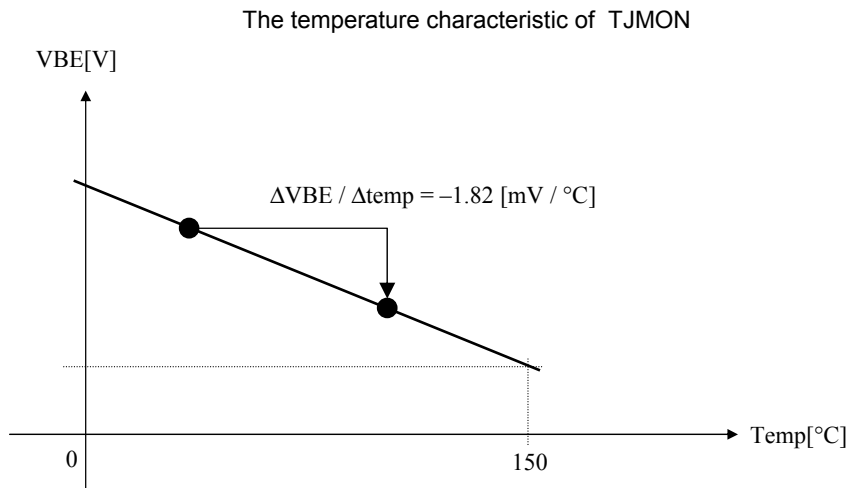

Fig. 3 Input impedance of PWMSW at VM power supply power on

■ Usage Notes (continued)

13. In the case of measuring the chip temperature of the IC, measure the voltage of TJMON (Pin 32) and presume chip temperature from following data. Use the following data as reference data. Before applying the IC to a product, conduct a sufficient reliability test of the IC along with the evaluation of the product with the IC incorporated.



14. Power supply start up speed and shutdown speed

Set the rising speed to 0.1 V/ μ s or less for VM voltage at power on to VM (Pin 1, 15).

It is recommended that the falling speed of VM voltage is set to 0.1 V/ μ s or less on condition of STBY = High or ENABLE = High at shutdown. In case of shutdown at motor drive (STBY = Low and ENABLE = Low), the motor current might flow back to the power supply and supply voltage might not fall stably.

If the rising or falling speed of power supply is too high, which might cause malfunctions or destruction on the IC. In this case, perform the long-term reliability test and confirm the sufficient evaluation for products.

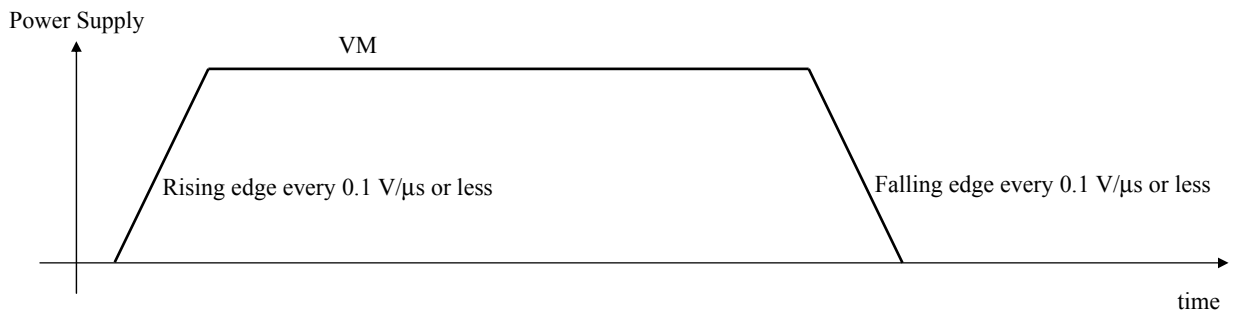

■ Usage Notes (continued)

15. RCS line

Take consideration in the following figure and the points and design PCB pattern.

(1) Point 1

Design so that the wiring to the current detection pins of this IC (RCSA, RCSB) should be thick and short in order to lower the impedance. This is why the current cannot be detected correctly owing to the wiring impedance, and the current might not be supplied to a motor sufficiently.

(2) Point 2

Design so that the wiring between the current detection resistor and the connector GND (Point 2 in the following figure) should be thick and short in order to lower the impedance. As the same as Point 1, a sufficient current might not be supplied due to the wiring impedance.

In addition, if there is a common impedance between GND and RCSA or RCSB, a peak detection may be detected by mistake. Therefore, connect the wiring between GND and RCSA or RCSB independently.

(3) Point 3

Connect the GND of this IC to the connector on PCB independently. Separate the wiring which is a large current line (Point 2) from that of GND, and make these wirings with one-point shorted at the connector as the following figure. That can minimize the fluctuation of GND.

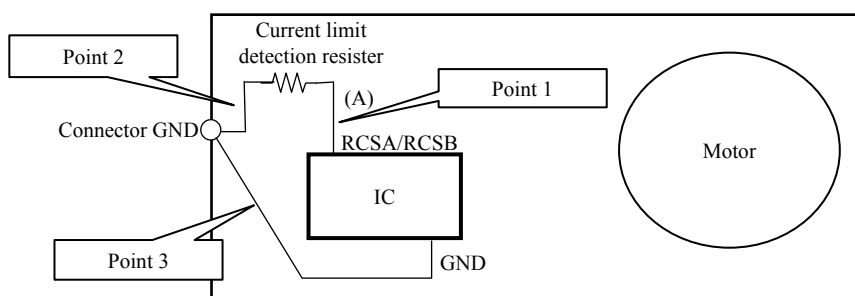

16. A high current flows into this IC. Therefore, the common impedance of the PCB pattern cannot be ignored. Take the following points into consideration and design the PCB pattern of the motor.

A high current flows into the line between the VM1 (Pin 1) and VM2 (Pin 15) pins. Therefore, noise is generated with ease at the time of switching due to the inductance (L) of the line, which may result in the malfunctioning or destruction of the IC. (Fig. 4) As shown in the circuit diagram on the right-hand side, the escape way of the noise is secured by connecting a capacitor to the connector close to the VM pin of the IC. This makes it possible to suppress the direct VM pin voltage of the IC. Make the settings as shown in the circuit diagram on Fig. 5 as much as possible.

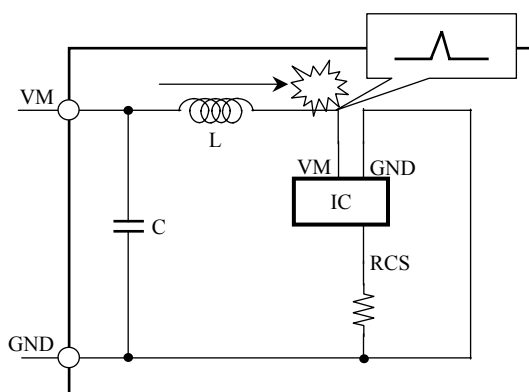

Fig. 4 Depreciated PCB

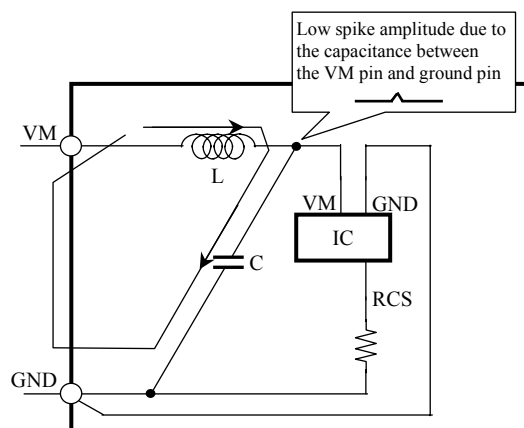

Fig. 5 Recommended PCB

Request for your special attention and precautions in using the technical information and semiconductors described in this book

- (1) If any of the products or technical information described in this book is to be exported or provided to non-residents, the laws and regulations of the exporting country, especially, those with regard to security export control, must be observed.
- (2) The technical information described in this book is intended only to show the main characteristics and application circuit examples of the products. No license is granted in and to any intellectual property right or other right owned by Panasonic Corporation or any other company. Therefore, no responsibility is assumed by our company as to the infringement upon any such right owned by any other company which may arise as a result of the use of technical information described in this book.
- (3) The products described in this book are intended to be used for standard applications or general electronic equipment (such as office equipment, communications equipment, measuring instruments and household appliances).
Consult our sales staff in advance for information on the following applications:
 - Special applications (such as for airplanes, aerospace, automobiles, traffic control equipment, combustion equipment, life support systems and safety devices) in which exceptional quality and reliability are required, or if the failure or malfunction of the products may directly jeopardize life or harm the human body.
 - Any applications other than the standard applications intended.
- (4) The products and product specifications described in this book are subject to change without notice for modification and/or improvement. At the final stage of your design, purchasing, or use of the products, therefore, ask for the most up-to-date Product Standards in advance to make sure that the latest specifications satisfy your requirements.
- (5) When designing your equipment, comply with the range of absolute maximum rating and the guaranteed operating conditions (operating power supply voltage and operating environment etc.). Especially, please be careful not to exceed the range of absolute maximum rating on the transient state, such as power-on, power-off and mode-switching. Otherwise, we will not be liable for any defect which may arise later in your equipment.
 - Even when the products are used within the guaranteed values, take into the consideration of incidence of break down and failure mode, possible to occur to semiconductor products. Measures on the systems such as redundant design, arresting the spread of fire or preventing glitch are recommended in order to prevent physical injury, fire, social damages, for example, by using the products.
- (6) Comply with the instructions for use in order to prevent breakdown and characteristics change due to external factors (ESD, EOS, thermal stress and mechanical stress) at the time of handling, mounting or at customer's process. When using products for which damp-proof packing is required, satisfy the conditions, such as shelf life and the elapsed time since first opening the packages.
- (7) This book may be not reprinted or reproduced whether wholly or partially, without the prior written permission of our company.