

PowerMOS transistor Logic level TOPFET

PIP3103-T

DESCRIPTION

Monolithic temperature and overload protected logic level power MOSFET in **TOPFET2** technology assembled in a 3 pin surface mount plastic package.

APPLICATIONS

General purpose switch for driving

- lamps
- motors
- solenoids
- heaters

FEATURES

- TrenchMOS output stage
- Current limiting
- Overload protection
- Overtemperature protection
- Protection latched reset by input
- 5 V logic compatible input level
- Control of output stage and supply of overload protection circuits derived from input
- Low operating input current permits direct drive by micro-controller
- ESD protection on all pins
- Overvoltage clamping for turn off of inductive loads

QUICK REFERENCE DATA

SYMBOL	PARAMETER	MAX.	UNIT
V_{DS}	Continuous drain source voltage	50	V
I_D	Continuous drain current	0.7	A
P_D	Total power dissipation	1.8	W
T_j	Continuous junction temperature	150	°C
$R_{DS(ON)}$	Drain-source on-state resistance	200	mΩ

FUNCTIONAL BLOCK DIAGRAM

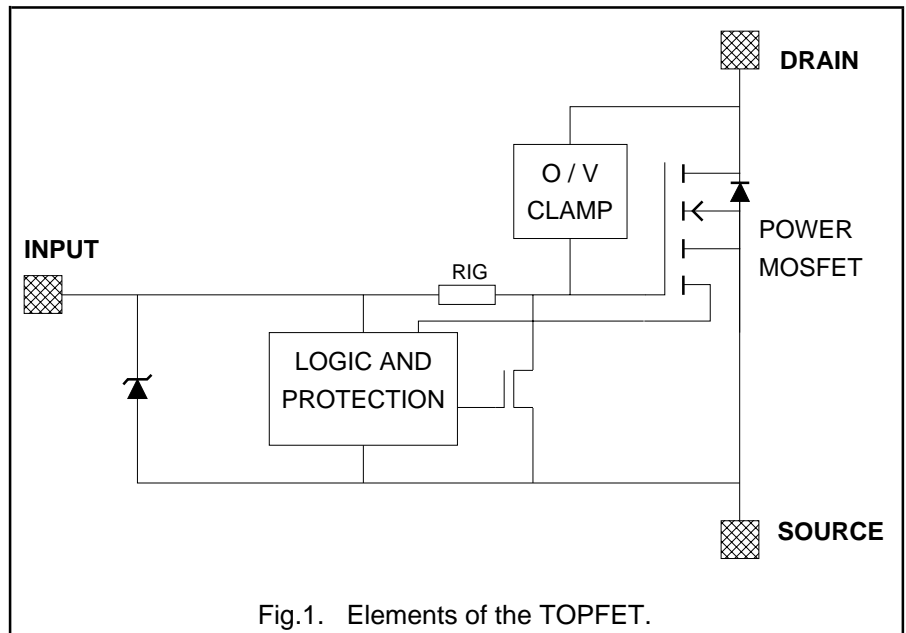

PINNING - SOT223

PIN	DESCRIPTION
1	input
2	drain
3	source
4	drain (tab)

PIN CONFIGURATION

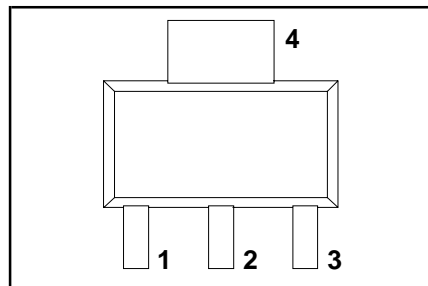

SYMBOL

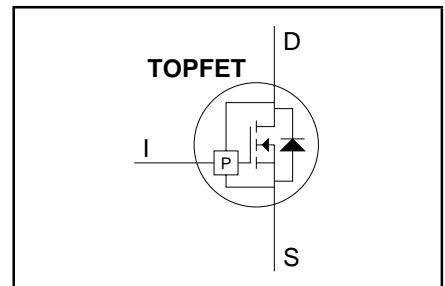

PowerMOS transistor Logic level TOPFET

PIP3103-T

LIMITING VALUES

Limiting values in accordance with the Absolute Maximum System (IEC 134)

SYMBOL	PARAMETER	CONDITIONS	MIN.	MAX.	UNIT
V_{DS}	Continuous drain source voltage ¹	-	-	50	V
I_D	Continuous drain current ²	-	-	self limiting	A
I_I	Continuous input current	clamping	-	3	mA
I_{IRM}	Non-repetitive peak input current	$t_p \leq 1$ ms	-	10	mA
P_D	Total power dissipation	$T_a = 25^\circ\text{C}$	-	1.8	W
T_{stg}	Storage temperature	-	-55	150	$^\circ\text{C}$
T_j	Continuous junction temperature	normal operation ³	-	150	$^\circ\text{C}$

ESD LIMITING VALUE

SYMBOL	PARAMETER	CONDITIONS	MIN.	MAX.	UNIT
V_C	Electrostatic discharge capacitor voltage	Human body model; $C = 250$ pF; $R = 1.5$ k Ω	-	2	kV

OVERVOLTAGE CLAMPING LIMITING VALUES

At a drain source voltage above 50 V the power MOSFET is actively turned on to clamp overvoltage transients.

SYMBOL	PARAMETER	CONDITIONS	MIN.	MAX.	UNIT
E_{DSM}	Non-repetitive clamping energy	$T_a \leq 25^\circ\text{C}$; $I_{DM} < I_{D(lim)}$; inductive load	-	100	mJ
E_{DRM}	Repetitive clamping energy	$T_{sp} \leq 125^\circ\text{C}$; $I_{DM} = 50$ mA; $f = 250$ Hz	-	5	mJ

OVERLOAD PROTECTION LIMITING VALUES

With the protection supply provided via the input pin, TOPFET can protect itself from short circuit loads.

Overload protection operates by means of drain current limiting and activating the overtemperature protection.

SYMBOL	PARAMETER	REQUIRED CONDITION	MIN.	MAX.	UNIT
V_{DDP}	Protected drain source supply voltage	$V_{IS} \geq 4$ V	-	35	V

THERMAL CHARACTERISTICS

SYMBOL	PARAMETER	CONDITIONS	MIN.	TYP.	MAX.	UNIT
$R_{th\ j-sp}$	Thermal resistance Junction to solder point		-	12	18	K/W
$R_{th\ j-b}$	Junction to board ⁴	Mounted on any PCB	-	40	-	K/W
$R_{th\ j-a}$	Junction to ambient	Mounted on PCB of fig. 22	-	-	70	K/W

¹ Prior to the onset of overvoltage clamping. For voltages above this value, safe operation is limited by the overvoltage clamping energy.

² Refer to OVERLOAD PROTECTION CHARACTERISTICS.

³ Not in an overload condition with drain current limiting.

⁴ Temperature measured 1.3 mm from tab.

PowerMOS transistor Logic level TOPFET

PIP3103-T

OUTPUT CHARACTERISTICS

Limits are for $-40^{\circ}\text{C} \leq T_{\text{mb}} \leq 150^{\circ}\text{C}$; typicals are for $T_{\text{mb}} = 25^{\circ}\text{C}$ unless otherwise specified

SYMBOL	PARAMETER	CONDITIONS	MIN.	TYP.	MAX.	UNIT
$V_{(\text{CL})\text{DSS}}$	Off-state Drain-source clamping voltage	$V_{\text{IS}} = 0 \text{ V}$	50	-	-	V
		$I_{\text{D}} = 10 \text{ mA}$ $I_{\text{D}} = 200 \text{ mA}; t_{\text{p}} \leq 300 \mu\text{s}; \delta \leq 0.01$	50	60	70	V
I_{DSS}	Drain source leakage current	$V_{\text{DS}} = 40 \text{ V}$	-	-	100	μA
		$T_{\text{mb}} = 25^{\circ}\text{C}$	-	0.1	10	μA
$R_{\text{DS(ON)}}$	On-state Drain-source resistance	$V_{\text{IS}} \geq 4 \text{ V}; t_{\text{p}} \leq 300 \mu\text{s}; \delta \leq 0.01$	-	-	380	$\text{m}\Omega$
		$I_{\text{D}} = 100 \text{ mA}$ $T_{\text{mb}} = 25^{\circ}\text{C}$	-	150	200	$\text{m}\Omega$

INPUT CHARACTERISTICS

The supply for the logic and overload protection is taken from the input.

Limits are for $-40^{\circ}\text{C} \leq T_{\text{mb}} \leq 150^{\circ}\text{C}$; typicals are for $T_{\text{mb}} = 25^{\circ}\text{C}$ unless otherwise specified

SYMBOL	PARAMETER	CONDITIONS	MIN.	TYP.	MAX.	UNIT	
$V_{\text{IS(TO)}}$	Input threshold voltage	$V_{\text{DS}} = 5 \text{ V}; I_{\text{D}} = 1 \text{ mA}$	0.6	-	2.4	V	
		$T_{\text{mb}} = 25^{\circ}\text{C}$	1.1	1.6	2.1	V	
I_{IS}	Input supply current	normal operation;	$V_{\text{IS}} = 5 \text{ V}$	100	220	400	μA
			$V_{\text{IS}} = 4 \text{ V}$	80	195	330	μA
I_{ISL}	Input supply current	protection latched;	$V_{\text{IS}} = 5 \text{ V}$	200	400	650	μA
			$V_{\text{IS}} = 3 \text{ V}$	130	250	430	μA
V_{ISR}	Protection reset voltage ¹	reset time $t_{\text{r}} \geq 100 \mu\text{s}$	1.5	2	2.9	V	
t_{r}	Latch reset time	$V_{\text{IS1}} = 5 \text{ V}, V_{\text{IS2}} < 1 \text{ V}$	10	40	100	μs	
$V_{(\text{CL})\text{IS}}$	Input clamping voltage	$I_{\text{I}} = 1.5 \text{ mA}$	5.5	-	8.5	V	
R_{IG}	Input series resistance ² to gate of power MOSFET	$T_{\text{mb}} = 25^{\circ}\text{C}$	-	33	-	$\text{k}\Omega$	

¹ The input voltage below which the overload protection circuits will be reset.

² Not directly measurable from device terminals.

PowerMOS transistor

Logic level TOPFET

PIP3103-T

OVERLOAD PROTECTION CHARACTERISTICS

TOPFET switches off to protect itself when one of the overload thresholds is exceeded. It remains latched off until reset by the input.

SYMBOL	PARAMETER	CONDITIONS	MIN.	TYP.	MAX.	UNIT
I_D	Overload protection Drain current limiting	$-40^\circ\text{C} \leq T_j \leq 150^\circ\text{C}$				
		$V_{IS} = 5\text{ V}$	0.8	1.3	1.7	A
		$V_{IS} = 4.5\text{ V}$	0.7	-	-	A
		$V_{IS} = 4\text{ V to } 5.5\text{ V}$	0.6	-	1.8	A
$P_{D(TO)}$	Short circuit load protection Overload power threshold	$V_{IS} = 5\text{ V}$				
		for protection to operate	-	17	-	W
T_{DSC}	Characteristic time	which determines trip time ¹	-	1.6	-	ms
$T_{j(TO)}$	Overtemperature protection Threshold junction temperature	from $I_D \geq 280\text{ mA}$ or $V_{DS} \geq 100\text{ mV}$ $V_{IS} = 4\text{ V to } 5.5\text{ V}$	150	165	-	$^\circ\text{C}$

SWITCHING CHARACTERISTICS

$T_a = 25^\circ\text{C}$; resistive load $R_L = 50\ \Omega$; adjust V_{DD} to obtain $I_D = 250\text{ mA}$; refer to test circuit and waveforms

SYMBOL	PARAMETER	CONDITIONS	MIN.	TYP.	MAX.	UNIT
$t_{d\ on}$	Turn-on delay time	$V_{IS}: 0\text{ V} \Rightarrow 5\text{ V}$	-	5	12	μs
t_r	Rise time		-	11	30	μs
$t_{d\ off}$	Turn-off delay time	$V_{IS}: 5\text{ V} \Rightarrow 0\text{ V}$	-	25	65	μs
t_f	Fall time		-	14	35	μs

REVERSE DIODE LIMITING VALUE

SYMBOL	PARAMETER	CONDITIONS	MIN.	MAX.	UNIT
I_S	Continuous forward current	$T_{mb} \leq 25^\circ\text{C}$; $V_{IS} = 0\text{ V}$	-	2	A

REVERSE DIODE CHARACTERISTICS

Limits are for $-40^\circ\text{C} \leq T_{mb} \leq 150^\circ\text{C}$; typicals are for $T_{mb} = 25^\circ\text{C}$ unless otherwise specified

SYMBOL	PARAMETER	CONDITIONS	MIN.	TYP.	MAX.	UNIT
V_{SDO}	Forward voltage	$I_S = 2\text{ A}$; $V_{IS} = 0\text{ V}$; $t_p = 300\ \mu\text{s}$	-	0.83	1.1	V
t_{rr}	Reverse recovery time	not applicable ²	-	-	-	-

¹ Trip time $t_{d\ sc}$ varies with overload dissipation P_D according to the formula $t_{d\ sc} \approx T_{DSC} / [P_D / P_{D(TO)} - 1]$.

² The reverse diode of this type is not intended for applications requiring fast reverse recovery.

PowerMOS transistor
Logic level TOPFET

PIP3103-T

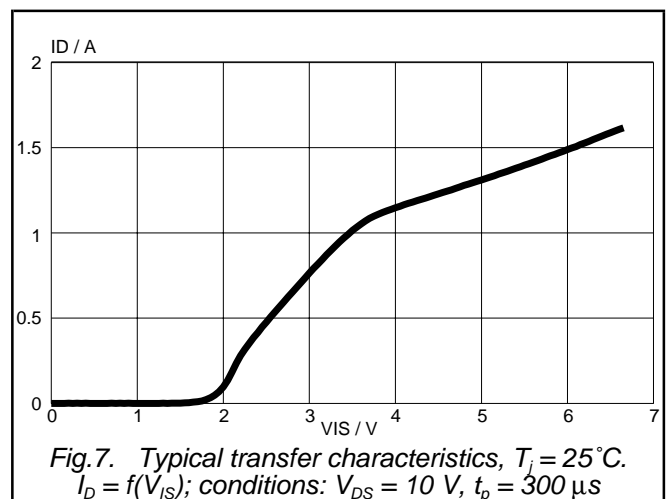
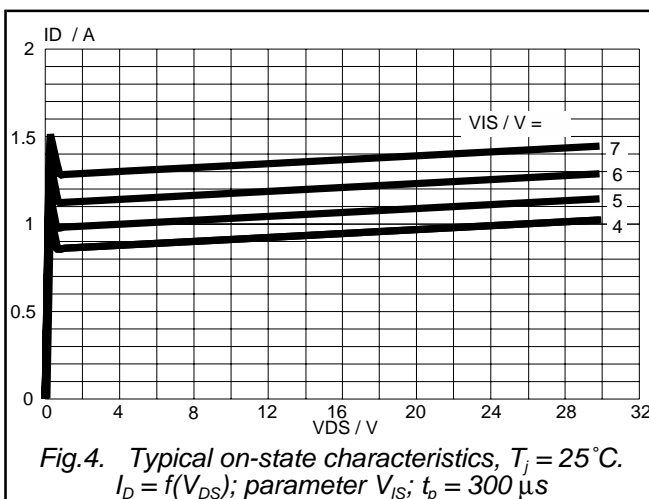
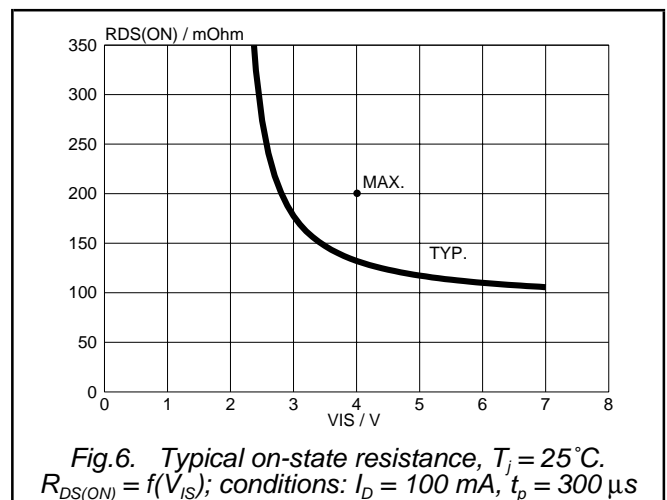
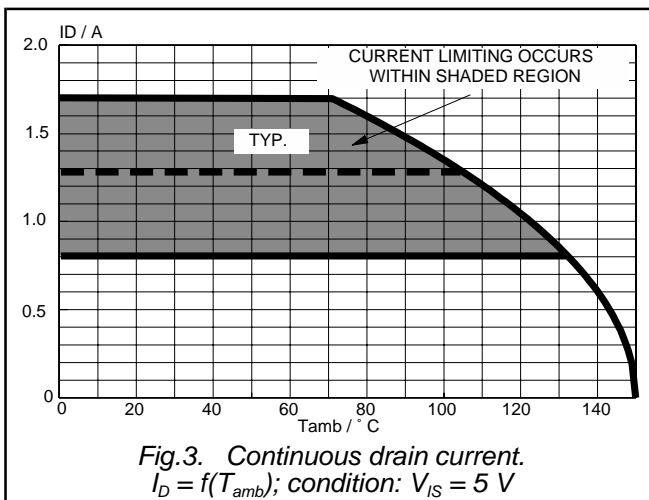
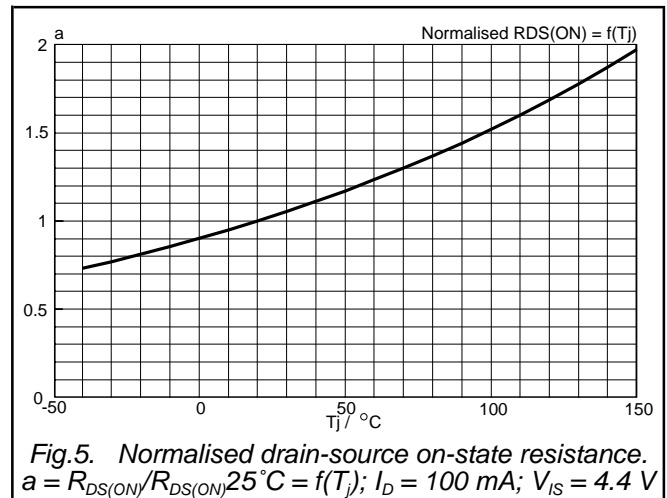
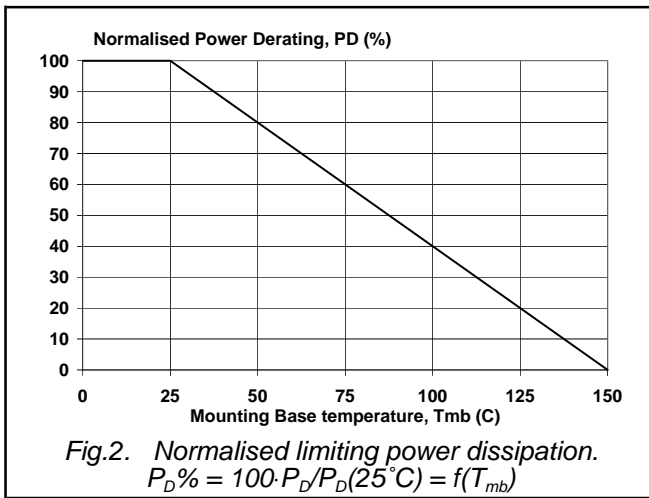

PowerMOS transistor
Logic level TOPFET

PIP3103-T

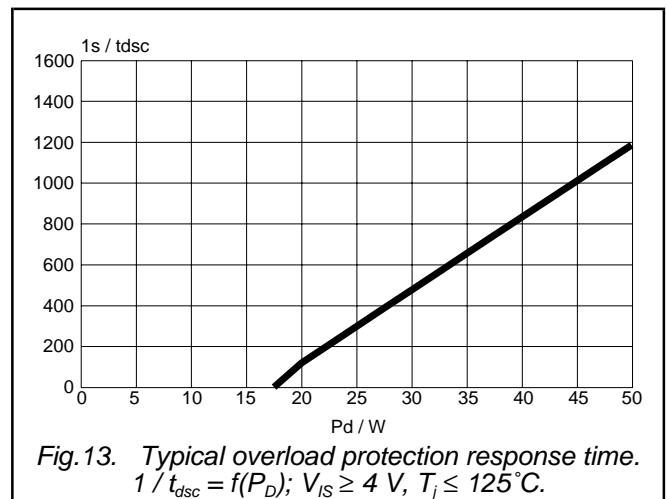
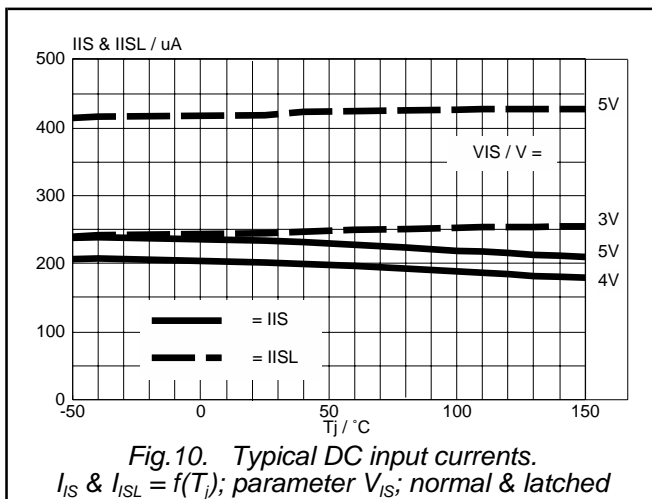
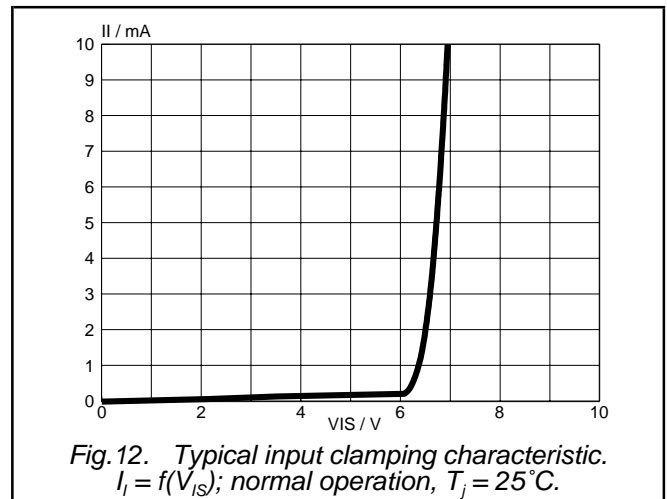
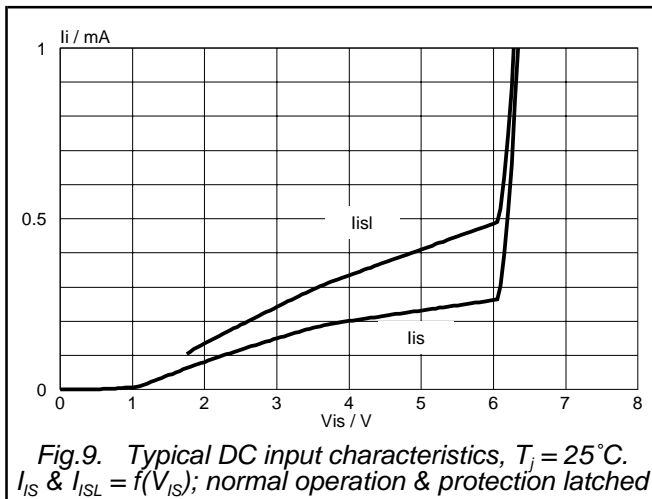
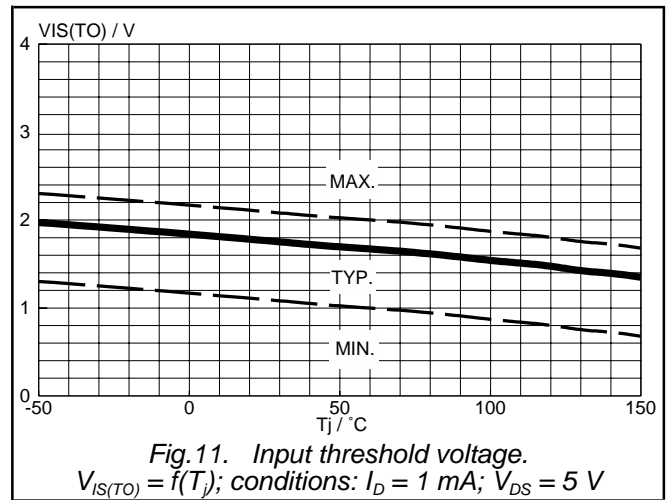
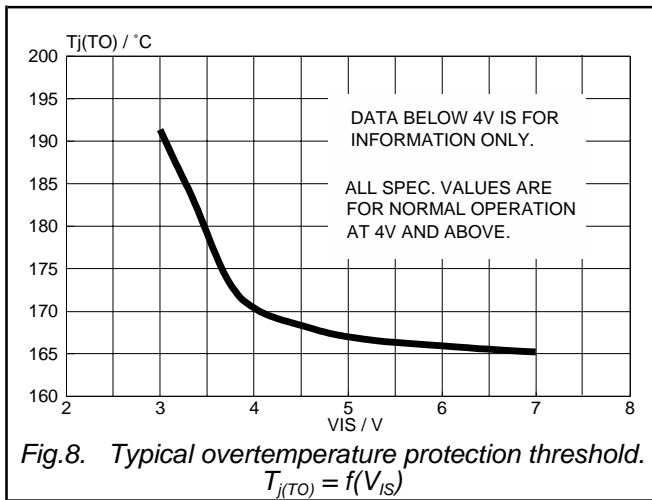

PowerMOS transistor
Logic level TOPFET

PIP3103-T

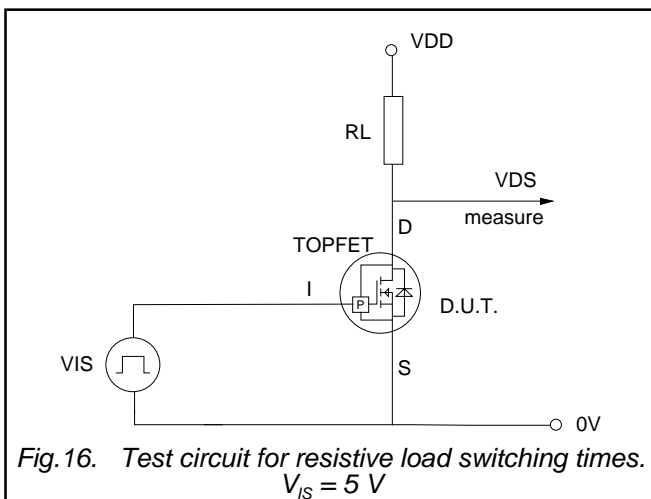
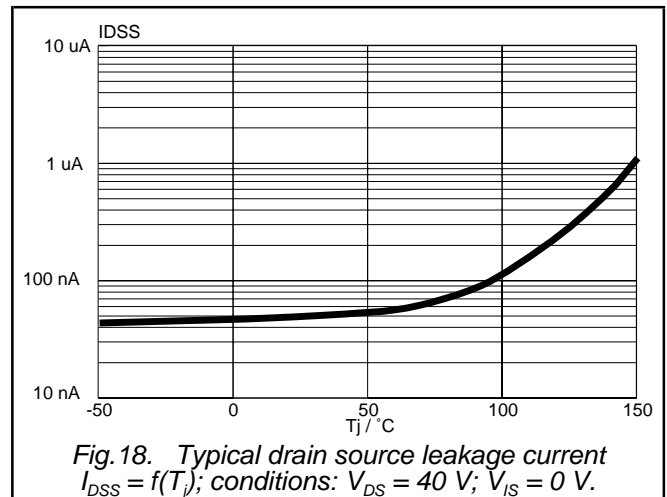
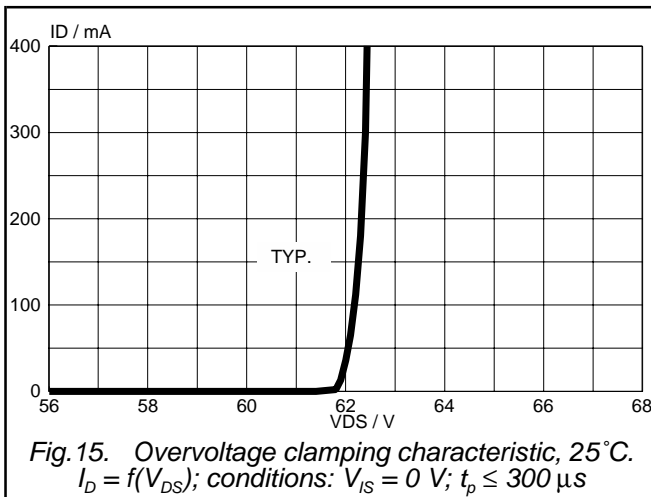
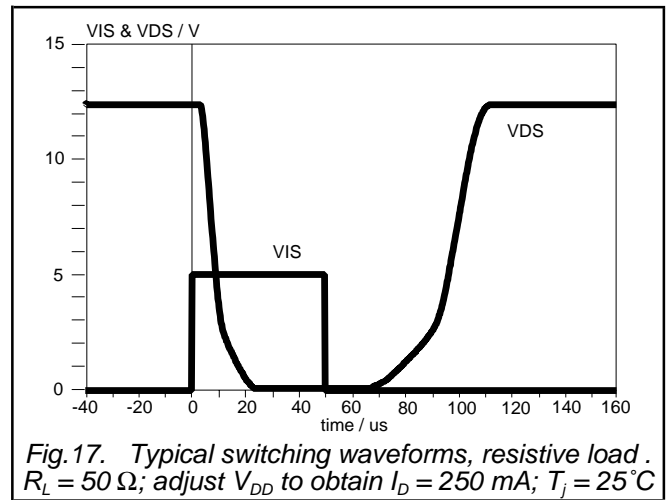
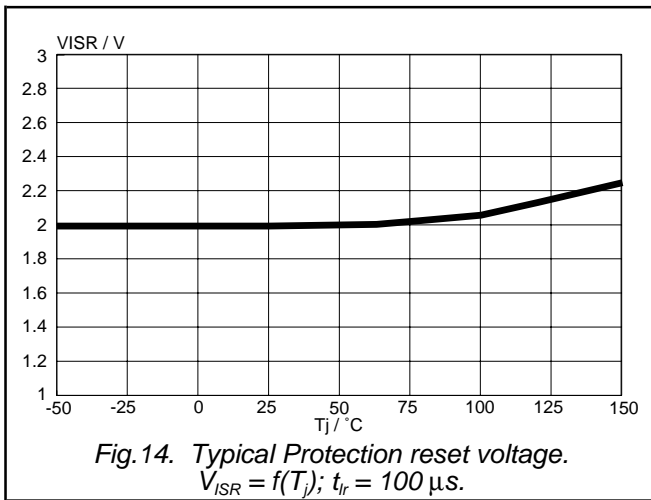

PowerMOS transistor
Logic level TOPFET

PIP3103-T

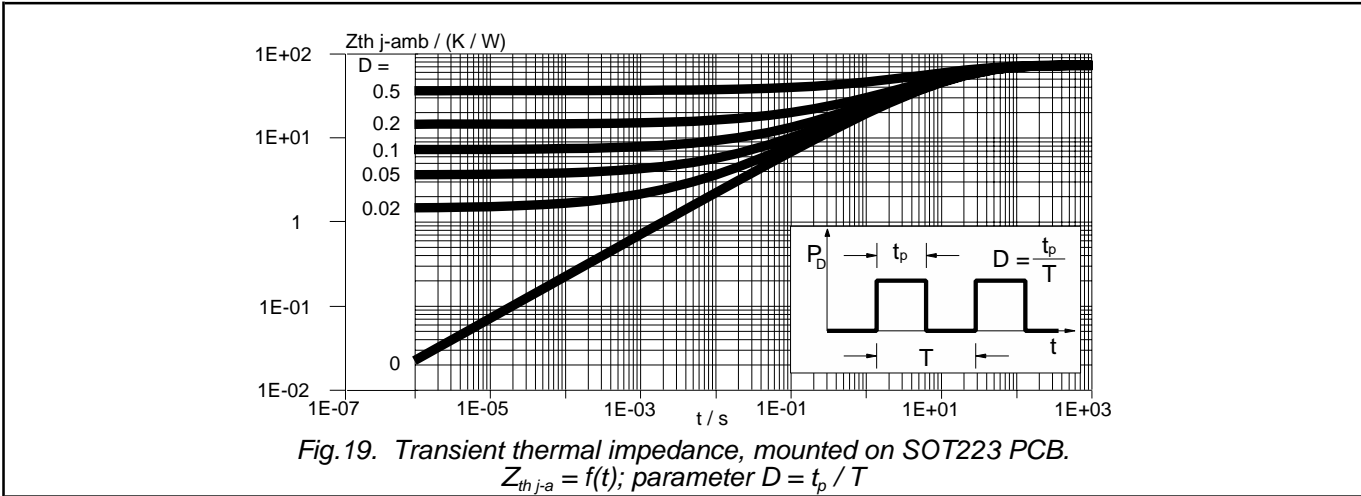

PowerMOS transistor
Logic level TOPFET

PIP3103-T

MECHANICAL DATA

Plastic surface mounted package; collector pad for good heat transfer; 4 leads

SOT223

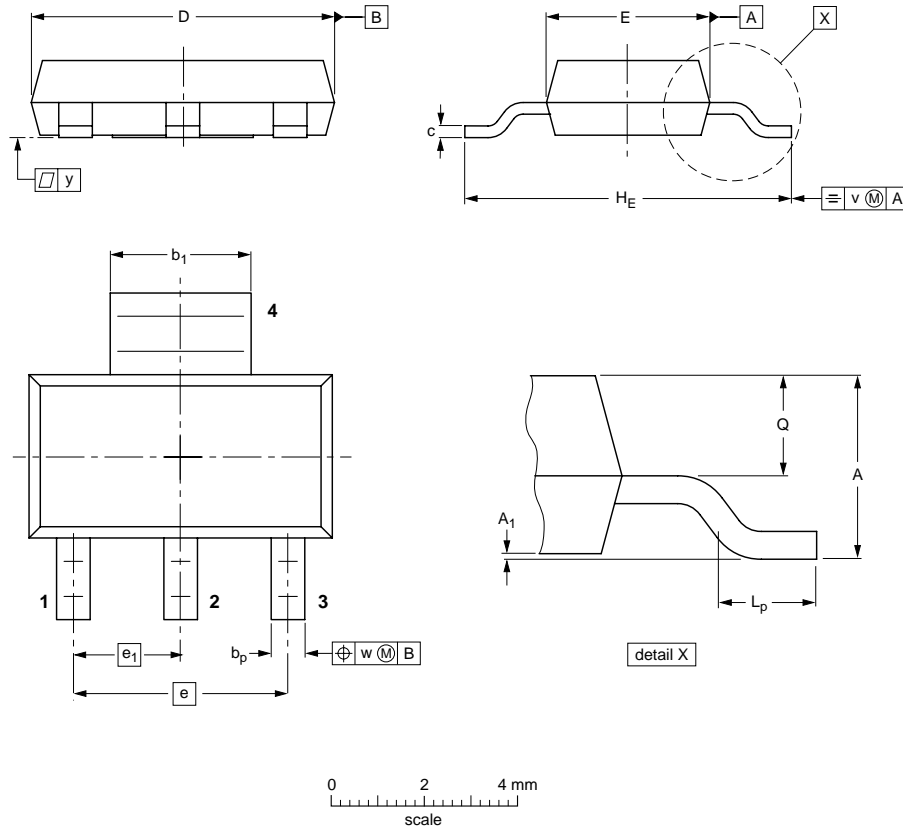

DIMENSIONS (mm are the original dimensions)

UNIT	A	A ₁	b _p	b ₁	c	D	E	e	e ₁	H _E	L _p	Q	v	w	y
mm	1.8 1.5	0.10 0.01	0.80 0.60	3.1 2.9	0.32 0.22	6.7 6.3	3.7 3.3	4.6	2.3	7.3 6.7	1.1 0.7	0.95 0.85	0.2	0.1	0.1

OUTLINE VERSION	REFERENCES				EUROPEAN PROJECTION	ISSUE DATE
	IEC	JEDEC	EIAJ			
SOT223						-96-11-11 97-02-28

Fig.20. SOT223 surface mounting package³.

³ For further information, refer to surface mounting instructions for SOT223 envelope. Epoxy meets UL94 V0 at 1/8". Net Mass: 0.11 g

PowerMOS transistor
Logic level TOPFET

PIP3103-T

MOUNTING INSTRUCTIONS

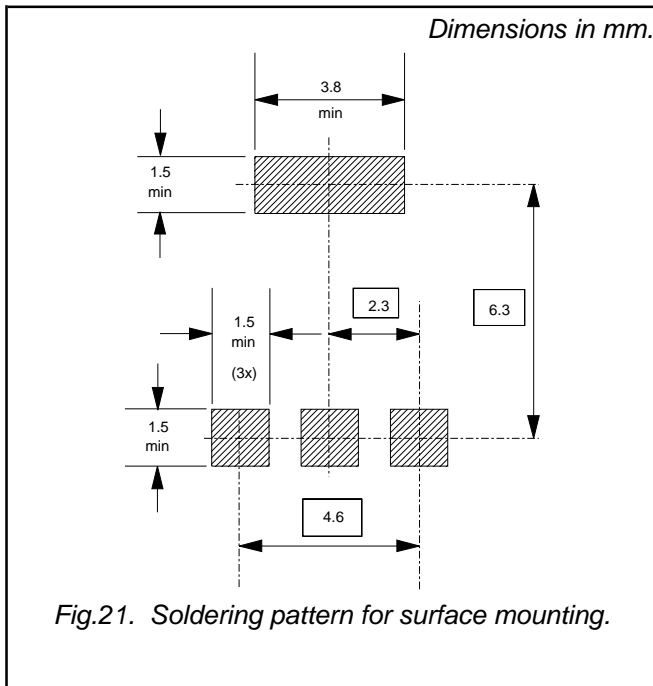

PRINTED CIRCUIT BOARD

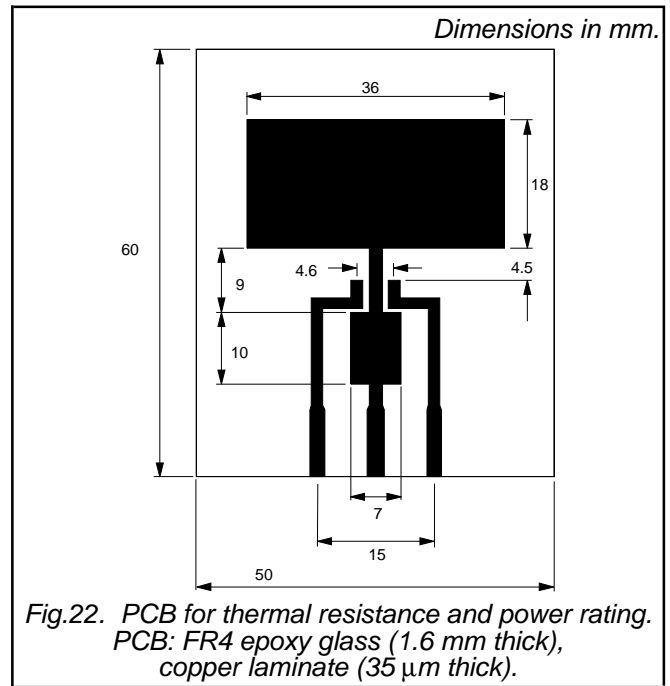

PowerMOS transistor

Logic level TOPFET

PIP3103-T

DEFINITIONS

DATA SHEET STATUS		
DATA SHEET STATUS ⁴	PRODUCT STATUS ⁵	DEFINITIONS
Objective data	Development	This data sheet contains data from the objective specification for product development. Philips Semiconductors reserves the right to change the specification in any manner without notice
Preliminary data	Qualification	This data sheet contains data from the preliminary specification. Supplementary data will be published at a later date. Philips Semiconductors reserves the right to change the specification without notice, in order to improve the design and supply the best possible product
Product data	Production	This data sheet contains data from the product specification. Philips Semiconductors reserves the right to make changes at any time in order to improve the design, manufacturing and supply. Changes will be communicated according to the Customer Product/Process Change Notification (CPCN) procedure SNW-SQ-650A
Limiting values		
Limiting values are given in accordance with the Absolute Maximum Rating System (IEC 134). Stress above one or more of the limiting values may cause permanent damage to the device. These are stress ratings only and operation of the device at these or at any other conditions above those given in the Characteristics sections of this specification is not implied. Exposure to limiting values for extended periods may affect device reliability.		
Application information		
Where application information is given, it is advisory and does not form part of the specification.		
© Philips Electronics N.V. 2001		
All rights are reserved. Reproduction in whole or in part is prohibited without the prior written consent of the copyright owner.		
The information presented in this document does not form part of any quotation or contract, it is believed to be accurate and reliable and may be changed without notice. No liability will be accepted by the publisher for any consequence of its use. Publication thereof does not convey nor imply any license under patent or other industrial or intellectual property rights.		

LIFE SUPPORT APPLICATIONS

These products are not designed for use in life support appliances, devices or systems where malfunction of these products can be reasonably expected to result in personal injury. Philips customers using or selling these products for use in such applications do so at their own risk and agree to fully indemnify Philips for any damages resulting from such improper use or sale.

⁴ Please consult the most recently issued datasheet before initiating or completing a design.

⁵ The product status of the device(s) described in this datasheet may have changed since this datasheet was published. The latest information is available on the Internet at URL <http://www.semiconductors.philips.com>.