

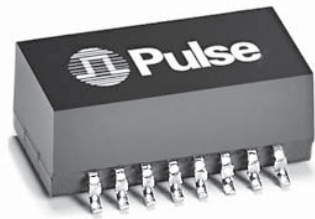



GIGABIT DUAL TRANSFORMERS

For Use with 150 Ω Twinax Cable



-  Compliant with ANSI X3T9.5, FC-PH-3 Fibre Channel Physical Layer Specification
-  Compliant with IEEE 802.3z PMD
-  Designed for fast rise-time and a low frequency cutoff of 2.5 MHz
-  IC grade transfer-molded package withstand 245°C peak temperature profile

Electrical Specifications @ 25°C — Operating Temperature 0°C to 70°C

| Part Number | Turns Ratio (±6%) | Primary Inductance OCL (µH MIN) (@ 20 mVRMS, 100 kHz) | DCR (Ω MAX) | Hi-Pot (VRMS) | Rise Time (ps MAX) 20-80% | Low Frequency Cutoff (-3 dB) |
|-------------|-------------------|---|-------------|---------------|---------------------------|------------------------------|
| A6801NL | 1CT:1CT | 5.50 | 0.21 | 1500 | 350 | ≤ 2.5 MHz |
| A6802NL | 1:1 | 5.50 | 0.21 | 1500 | 280 | ≤ 2.5 MHz |

Mechanical

A680XNL

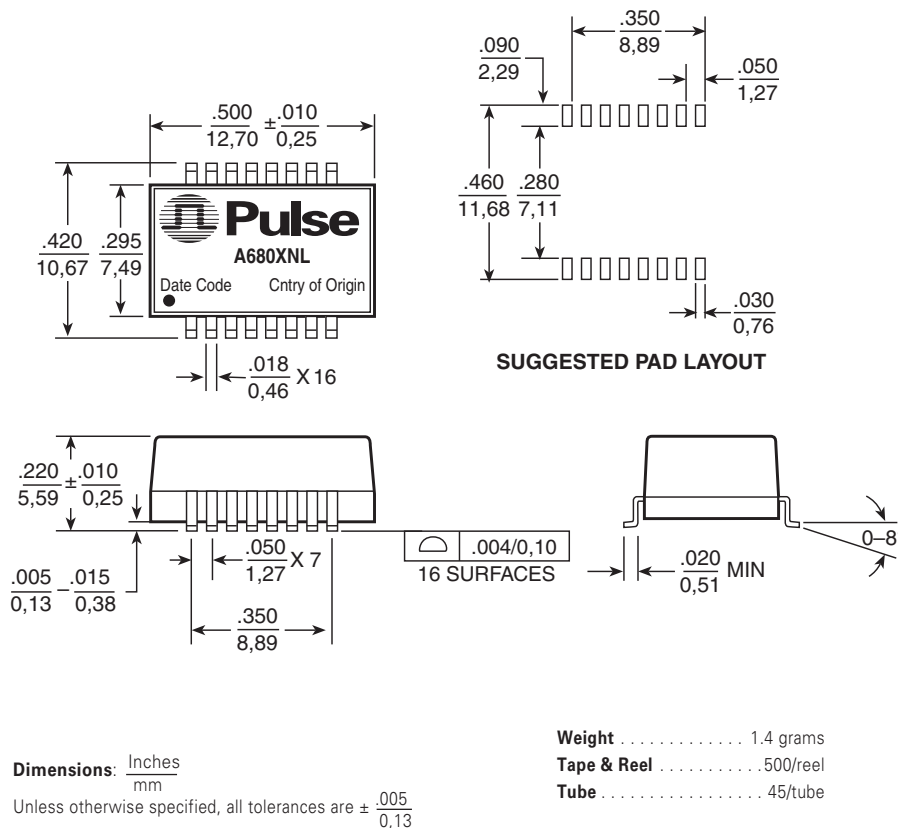

NOTE: For lower speed Fibre Channel applications, please refer to application note on data sheet A101.

Schematics

A6801NL

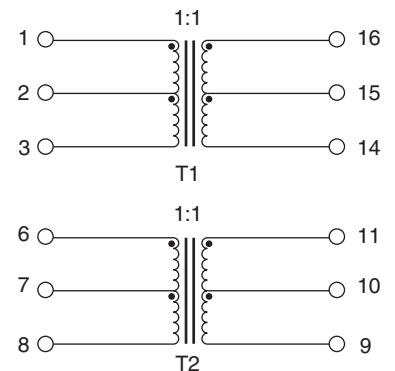

A6802NL

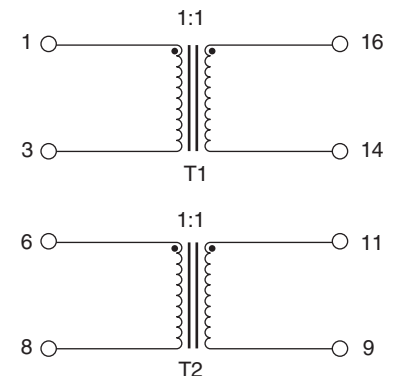

GIGABIT DUAL TRANSFORMERS

For Use with 150 Ω Twinax Cable



Application Notes:

Pulse has designed Gigabit Dual Transformers specifically for point to point coupling to 150 Ω Twinax cable. The isolation transformers protect the station from static charges that may develop on the cable and prevent ground loop currents from being transferred between stations. The devices have also been designed to provide common mode rejection within the transmission band and thus reduce EMI. The bandwidth of

these devices minimizes data dependent jitter by providing fast signal rise times. The dual package allows connection of both the transmit and receive channels as shown in the application circuit below. Surface mount packaging also allows a cost-effective solution. The transformers are available in either tubes or Tape & Reel packaging.

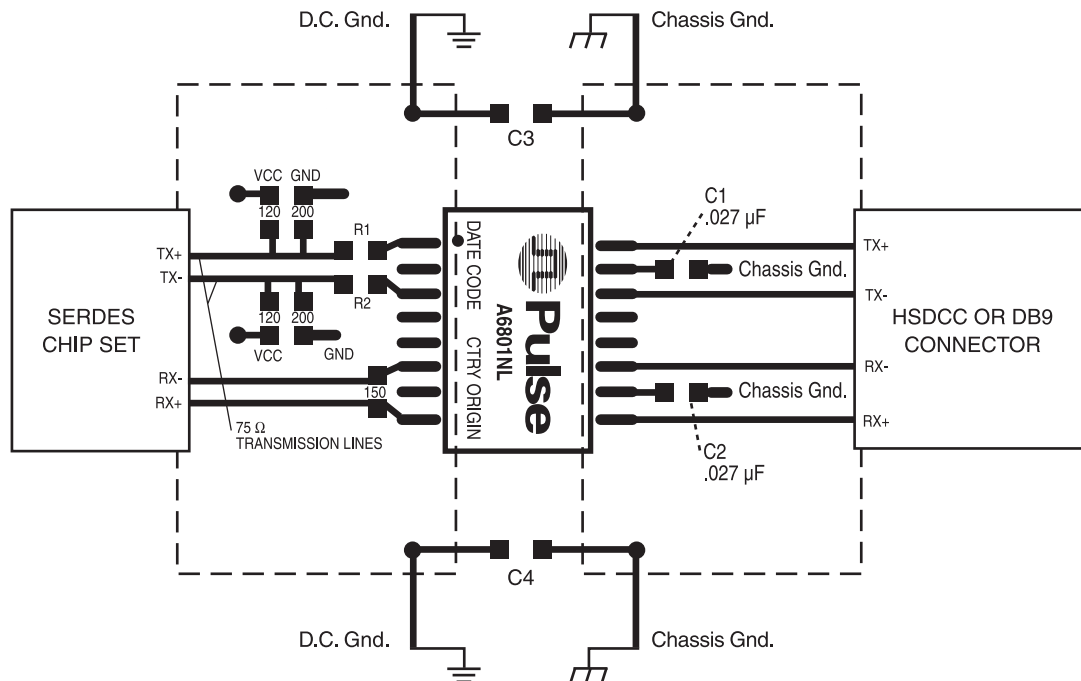

1. R1 and R2 values should be based upon the transmit amplitude required for the system. Placing a short (0 Ω) will result in maximum amplitude. However, doing so will result in distortion on the output due to impedance mismatch. For optimum design, R1 and R2 should be approximately 68 Ω for each leg. This will result in a -6.0 dB insertion loss (transmitter section). If this is too much insertion loss, then at least a 15 Ω for R1 and R2 is recommended.

Insertion Loss of Transmitter:

$$R_{eq} = R1 + R2 \text{ and } Z_0 = 150 \Omega$$

$$\text{Insertion Loss} = 20 \log [Z_0 / R_{eq} + Z_0]$$

2. When designing PCB layout, transmission line methods must be utilized to maintain return loss and signal integrity. Transformer should be located within 1" of cable connector.
3. $t_r \text{ transformer} = \sqrt{[(t_{rout})^2 - (t_{rin})^2]}$
4. The typical application circuit shown above is a suggested layout. Actual board layout may vary based upon individual applications and EMC concerns.

NOTE:

These gigabit dual transformers are packaged in tubes unless Tape & Reel is specified. When ordering, add the suffix "T" (i.e. A6801NLT) for "Tape & Reel" packaging in increments of 500.

For More Information:

Pulse Worldwide Headquarters

12220 World Trade Dr.
San Diego, CA 92128
U.S.A.

www.pulseeng.com

Tel: 858 674 8100
Fax: 858 674 8262

Pulse Europe

Einsteinstrasse 1
D-71083 Herrenberg
Germany

Tel: 49 7032 7806 0
Fax: 49 7032 7806 135

Pulse China Headquarters

B402, Shenzhen Academy of
Aerospace Technology Bldg.
10th Kejinan Rd.
High-Tech Zone
Nanshan District
Shenzhen, PR China 518057

TEL: 86 755 33966678
FAX: 86 755 33966700

Pulse North China

Room 1503
XinYin Building
No. 888 YiShan Rd.
Shanghai 200233
China

Tel: 86 21 54643211/2
Fax: 86 21 54643210

Pulse South Asia

135 Joo Seng Rd.
#03-02
PM Industrial Bldg.
Singapore 368363

TEL: 65 6287 8998
FAX: 65 6280 0080

Pulse North Asia

No. 26, Kao Ching Rd.
Yang Mei Chen
Taoyuan Hsien
Taiwan
R. O. C.

Tel: 886 3 4643715
Fax: 886 3 4641911

Performance warranty of products offered on this data sheet is limited to the parameters specified. Data is subject to change without notice. Other brand and product names mentioned herein may be trademarks or registered trademarks of their respective owners.

© Copyright, 2009. Pulse Engineering, Inc. All rights reserved.

www.pulseeng.com