

NCV8613B

Ultra-Low Iq Automotive System Power Supply IC Power Saving Triple-Output Linear Regulator

The NCV8613B is a multiple output linear regulator IC's with an Automatic Switchover (ASO) input voltage selector. The ASO circuit selects between three different input voltage sources to reduce power dissipation and to maintain the output voltage level across varying battery line voltages associated with an automotive environment.

The NCV8613B is specifically designed to address automotive radio systems and instrument cluster power supply requirements. The NCV8613B can be used in combination with the 4-Output Controller/Regulator IC, NCV885x, to form a complete automotive radio or instrument cluster power solution. The NCV8613B is intended to supply power to various "always on" loads such as the CAN transceivers and microcontrollers (core, memory and IO). The NCV8613B has three output voltages, a reset / delay circuit, and a host of control features suitable for the automotive radio and instrument cluster systems.

Features

- Operating Range 7.0 V to 18.0 V (45 V Load Dump Tolerant)
- Output Voltage Tolerance, All Rails, $\pm 2\%$
- $< 50 \mu\text{A}$ Quiescent Current
- Independent Input for LDO3 Linear Regulator
- High Voltage Ignition Buffer
- Automatic Switchover Input Voltage Selector
- Independent Input Voltage Monitor with a High Input Voltage and Low Input Voltage (Brown-out) Indicators
- Thermal Warning Indicator with Thermal Shutdown
- Single Reset with Externally Adjustable Delay for the 3.3 V Rail
- Push-Pull Outputs for Logic Level Control Signals
- All Ceramic Solution for Reduced Leakage Current at the Output
- NCV Prefix for Automotive and Other Applications Requiring Site and Control Changes
- This is a Pb-Free Device

Applications

- Automotive Radio
- Instrument Cluster



ON Semiconductor®

<http://onsemi.com>

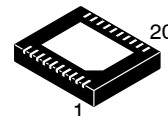

DFN20
MN SUFFIX
CASE 505AB

MARKING DIAGRAM

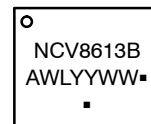

- A = Assembly Location
- WL = Wafer Lot
- YY = Year
- WW = Work Week
- = Pb-Free Package

(Note: Microdot may be in either location)

PIN CONNECTIONS

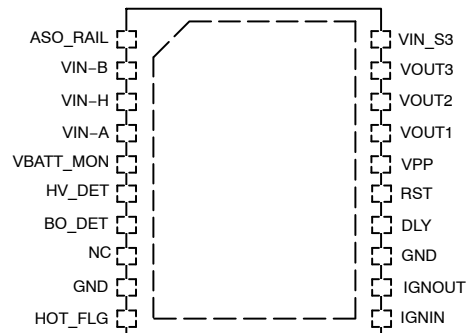

ORDERING INFORMATION

Device	Package	Shipping†
NCV8613BMNR2G	DFN20 (Pb-Free)	2500 / Tape & Reel

†For information on tape and reel specifications, including part orientation and tape sizes, please refer to our Tape and Reel Packaging Specification Brochure, BRD8011/D.

NCV8613B

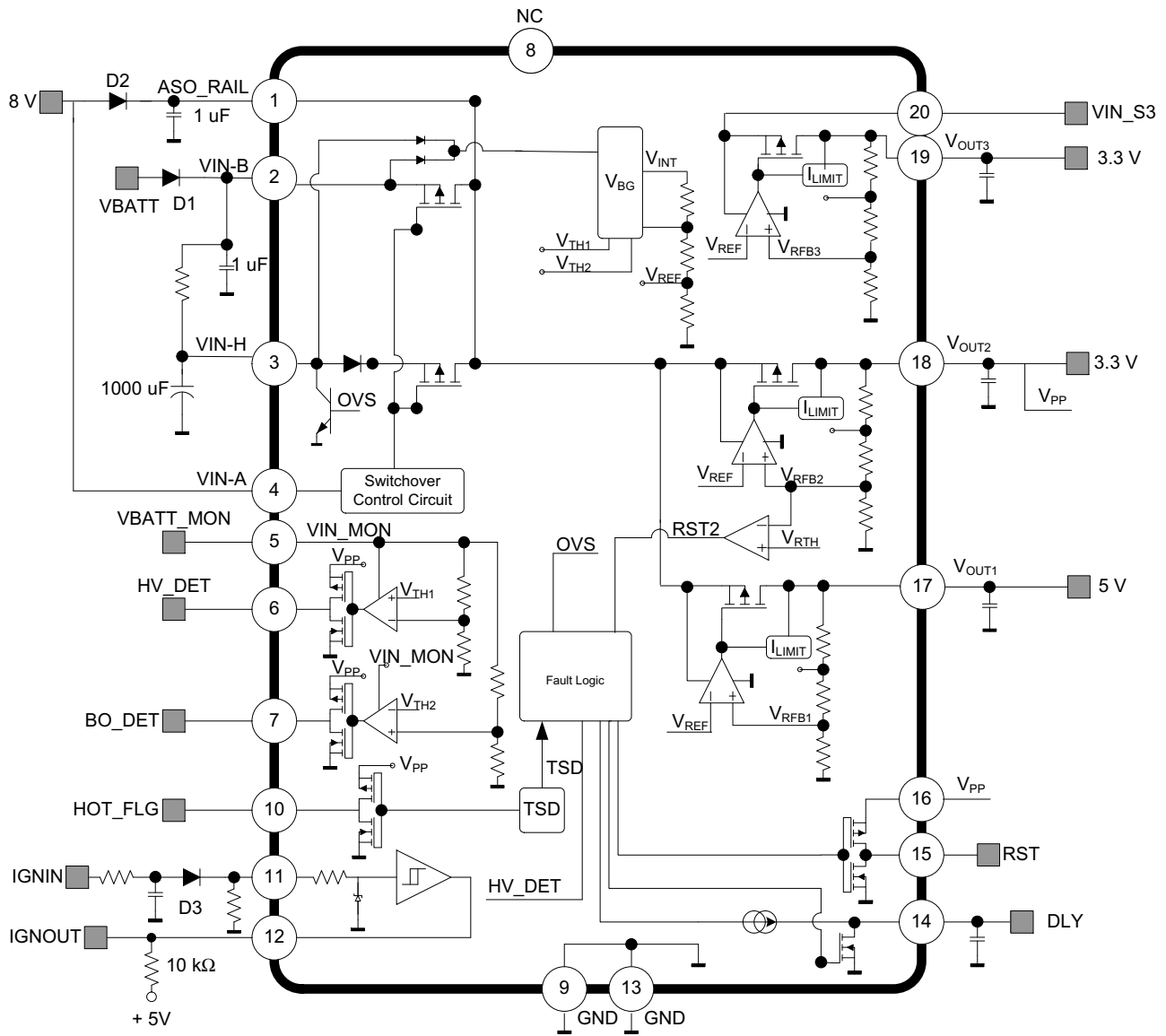

Components	Value	Manufacturer
D1	MBRS2H100T3G	ON Semiconductor
D2	MBR130T1	ON Semiconductor
D3	MMDL914T1	ON Semiconductor

Figure 1. Typical Circuit with the Internal Schematic

NCV8613B

PIN FUNCTION DESCRIPTIONS

Pin No.	Symbol	Description
1	ASO_RAIL	Output/Input of the automatic switchover (ASO) circuitry. Place a 1 uF ceramic capacitor on this pin to provide local bypassing to the LDO linear regulator pass devices.
2	VIN-B	Primary power supply input. Connect battery to this pin through a blocking diode.
3	VIN-H	Holdup power supply rail. Connect a storage capacitor to this pin to provide a temporary backup rail during loss of battery supply. A bleed resistor (typically 1 k Ω) is needed from VIN-B to this pin in order to trickle charge this capacitor.
4	VIN-A	Voltage monitor which determines whether the 8 V supply is able to power the outputs. If the 8 V supply is present, the FET's connected to VIN-B and VIN-H will be turned off, and the 8 V supply will be providing power to the outputs. If the 8 V supply is not present, the FET's on VIN-B and VIN-H will be left on, and the greater of those voltages will be driving the outputs.
5	VBATT_MON	VBATT monitor pin. To operate overvoltage shutdown, HV_DET and BO_DET, connect this pin to ASO_RAIL or battery. To eliminate overvoltage shutdown, HV_DET and BO_DET, tie this pin to ground.
6	HV_DET	High-voltage detect output. When VBATT_MON surpasses 17 V, this pin will be driven to ground. During normal operation, this pin is held at V _{PP} .
7	BO_DET	Brown out indicator output. When VBATT_MON and VIN-A falls below 7.5 V, this pin will be driven to ground. During normal operation, this pin is held at V _{PP} .
8	NC	No Connect
9	GND	Ground. Reference point for internal signals. Internally connected to pin 13. Ground is <i>not</i> connected to the exposed pad of the DFN20 package.
10	HOT_FLG	Thermal warning indicator. This pin provides an early warning signal of an impending thermal shutdown.
11	IGNIN	Ignition buffer input
12	IGOUT	Ignition buffer logic output
13	GND	Ground. Reference point for internal signals. Internally connected to pin 9. Ground is <i>not</i> connected to the exposed pad of the DFN20 package.
14	DLY	Delay pin. Connect a capacitor to this pin to set the delay time.
15	RST	Reset pin. Monitors V _{OUT1} .
16	V _{PP}	Supply rail for the push-pull outputs of the control signals HOT_FLG, RST, HV_DET & BO_DET
17	V _{OUT1}	5 V output. Voltage is internally set.
18	V _{OUT2}	3.3 V output. Voltage is internally set.
19	V _{OUT3}	3.3 V output. Voltage is internally set.
20	VIN_S3	Supply rail for the standby linear regulator V _{OUT3} . Tie this pin to ASO_RAIL or a separate supply rail.
EP	-	Exposed Pad of DFN device. This pad serves as the main path for thermal spreading. The Exposed Pad is not connected to IC ground.

NCV8613B

MAXIMUM RATINGS (Voltages are with respects to GND unless noted otherwise)

Rating	Symbol	Max	Min	Unit
Maximum DC Voltage	VIN-B, VIN-A, ASO_RAIL, VBATT_MON, VIN_S3, ĒN, IGNIN	40	-0.3	V
Peak Transient	VIN-B, VIN-A, ASO_RAIL, VBATT_MON, VIN_S3, ĒN, IGNIN	45	-0.3	V
Maximum DC Voltage	VIN-H	24	-0.3	V
Maximum DC Voltage	IGNOUT, V _{PP} , HV_DET, BO_DET, HOT_FLG, RST, DLY, V _{OUT1} , V _{OUT2} , V _{OUT3}	7	-0.3	V

Stresses exceeding Maximum Ratings may damage the device. Maximum Ratings are stress ratings only. Functional operation above the Recommended Operating Conditions is not implied. Extended exposure to stresses above the Recommended Operating Conditions may affect device reliability.

THERMAL INFORMATION

Rating	Symbol	Min	Unit
Thermal Characteristic (Note 1)	R _{θJA}	40	°C/W
Operating Junction Temperature Range	T _J	-40 to 150	°C
Maximum Storage Temperature Range	T _{STG}	-55 to +150	°C
Moisture Sensitivity Level	MSL	1	

- Values based on measurement of NCV8613B assembled on 2-layer 1-oz Cu thickness PCB with Copper Area of more than 645 mm² with several thermal vias for improved thermal performance. Refer to CIRCUIT DESCRIPTION section for safe operating area.

ATTRIBUTES

Rating	Symbol	Min	Unit
ESD Capability, Human Body Model (Note 2)	ESD _{HB}	2	kV
ESD Capability, Machine Model (Note 2)	ESD _{MM}	200	V
ESD Capability, Charged Device Model (Note 2)	ESD _{CDM}	1	kV
IGNIN ESD Capability, Human Body Model (Note 2)	ESD _{HB_IGNIN}	3	kV
IGNIN ESD Capability, Machine Model (Note 2)	ESD _{MM_IGNIN}	200	V
IGNIN ESD Capability (Note 3)	ESD_IGNIN	10	kV

- This device series incorporates ESD protection and is tested by the following methods:
 - ESD Human Body Model (HBM) tested per AEC-Q100-002 (EIA/JESD22-A114)
 - ESD Machine Model (MM) tested per AEC-Q100-003 (EIA/JESD22-A115)
 - ESD Charged Device Model (CDM) tested per EIA/JES D22/C101, Field Induced Charge Model
- Device tested with external 10 kΩ series resistance and 1 nF storage capacitor.

NCV8613B

SUPPLY VOLTAGES AND SYSTEM SPECIFICATION ELECTRICAL CHARACTERISTICS (7 V < ASO_RAIL < 18 V, VIN-H = VIN-B ≥ ASO_RAIL, V_{PP} = 5 V, VIN_S3 tied to ASO_RAIL, VBATT_MON = 0 V, IGNIN = 0 V, I_{SYS} = 3 mA (Note 6))
 Minimum/Maximum values are valid for the temperature range -40°C ≤ T_J ≤ 150°C unless noted otherwise. Min/Max values are guaranteed by test, design or statistical correlation.

Parameter	Symbol	Conditions	Min	Typ	Max	Unit
-----------	--------	------------	-----	-----	-----	------

SUPPLY RAILS

Quiescent Current (Notes 4 and 6)	i _q	T _J = 25°C, I _{SYS} = 70 μA, VIN-A = VIN_S3 = 0 V, VIN-B = 13.2 V		34	50	μA
Minimum Operating Voltage (VIN-H, VIN-B)			4.5			V

THERMAL MONITORING

Thermal Warning (HOT_FLG) Temperature	T _{WARN}		140	150	160	°C
T _{WARN} Hysteresis			10		20	°C
Thermal Shutdown			160	170	180	°C
Thermal Shutdown Hysteresis			10		20	°C
Delta Junction Temperature (TSD - T _{WARN})			10	20	30	°C
HOT_FLG Voltage Low		T _J < T _{WARN} , 10 kΩ Pullup to 3.3 V			0.4	V
HOT_FLG Voltage High		T _J > T _{WARN} , 10 kΩ Pulldown to GND	V _{PP} -0.5			V

AUTO SWITCHOVER

VIN-A Quiescent Current				24		μA
VIN-A to VIN-B Risetime		T _J = 25°C, C _{ASO_RAIL} = 1 μF, I _{SYS} = 400 mA		200		μsec
VIN-B to VIN-A Falltime		T _J = 25 °C, C _{ASO_RAIL} = 1 μF, I _{SYS} = 400 mA		100		μsec
VIN-A Operating Threshold		VIN-A Rising	7.2	7.5	7.75	V
VIN-A Operating Hysteresis		VIN-A Falling	100	175	250	mV
Max VIN-B to V _{ASO_RAIL} Voltage Drop		I _{SYS} = 400 mA, VIN-B = 7 V			1.5	V
Max VIN-H to V _{ASO_RAIL} Voltage Drop		I _{SYS} = 400 mA, VIN-H = 7.5 V			2.0	V

RESET (RST Pin)

RESET Threshold		% of V _{OUT2}	90	93	96	%
Hysteresis		% of V _{OUT2}			2.5	%
Reset Voltage High		10 kΩ Pulldown to GND	V _{PP} -0.5			V
Reset Voltage Low		10 kΩ Pullup to 3.3 V			0.4	V

DELAY (DLY Pin)

Charge Current			2.4	5	7	μA
Delay Trip Point Voltage				2.0		V

IGNITION BUFFER

Schmitt Trigger Rising Threshold			2.75	3.25	3.75	V
Schmitt Trigger Falling Threshold			0.8	1.0	1.2	V
IGNOUT Voltage Low		IGNIN = 5 V, 10 kΩ Pullup to 5 V			0.4	V
IGNOUT Leakage Current		T _J = 25°C, IGNOUT = 5 V		0.1	0.5	μA

VBATT MONITOR

VBATT_MON Quiescent Current		T _J = 25°C, VBATT_MON = 13.2 V		3	5	μA
VBATT_MON Minimum Operating Voltage		Threshold where BO_DET and HV_DET signals become valid	1.0	2.0	2.5	V

NCV8613B

SUPPLY VOLTAGES AND SYSTEM SPECIFICATION ELECTRICAL CHARACTERISTICS (7 V < ASO_RAIL < 18 V, VIN-H = VIN-B ≥ ASO_RAIL, V_{PP} = 5 V, VIN_S3 tied to ASO_RAIL, VBATT_MON = 0 V, IGNIN = 0 V, I_{SYS} = 3 mA (Note 6))
 Minimum/Maximum values are valid for the temperature range -40°C ≤ T_J ≤ 150°C unless noted otherwise. Min/Max values are guaranteed by test, design or statistical correlation.

Parameter	Symbol	Conditions	Min	Typ	Max	Unit
-----------	--------	------------	-----	-----	-----	------

VBATT MONITOR

VBATT_MON Hysteresis				0.25		V
HV_DET Voltage High		10 kΩ Pulldown to GND VBATT_MON Tied to ASO_RAIL	V _{PP} -0.5			V
HV_DET Voltage Low		10 kΩ Pullup to 3.3 V VBATT_MON Tied to ASO_RAIL			0.4	V
HV_DET Threshold		VBATT_MON Rising	16.2		17.8	V
HV_DET Hysteresis		VBATT_MON Falling	0.2	0.35	0.5	V
BO_DET Voltage High		10 kΩ Pulldown to GND VBATT_MON Tied to ASO_RAIL	V _{PP} -0.5			V
BO_DET Voltage Low		10 kΩ Pullup to 3.3 V VBATT_MON Tied to ASO_RAIL			0.4	V
BO_DET Threshold		VBATT_MON Falling	7	7.5	8	V
BO_DET Hysteresis		VBATT_MON Rising	0.2	0.35	0.5	V

VPP PIN

VPP Voltage Range			3	5	6	V
Leakage Current		T _J = 25°C		0.1	0.5	μA

4. i_q is equal to $I_{VIN-B} + I_{VIN-H} - I_{SYS}$
5. I_{SHDN} is equal to $I_{VIN-B} + I_{VIN-H}$
6. I_{SYS} is equal to $I_{OUT1} + I_{OUT2} + I_{OUT3}$

NCV8613B

ELECTRICAL CHARACTERISTICS (7 V < ASO_RAIL < 18 V, VIN-H = VIN-B ≥ ASO_RAIL, V_{PP} = 5 V, VIN_S3 tied to ASO_RAIL, VBATT_MON = 0 V, IGNIN = 0 V, I_{SYS} = 3 mA (Note 6)) Min/Max values are valid for the temperature range -40°C ≤ T_J ≤ 150 °C unless noted otherwise. Min/Max values are guaranteed by test, design or statistical correlation.

Parameter	Symbol	Conditions	Min	Typ	Max	Unit
-----------	--------	------------	-----	-----	-----	------

LOW DROP-OUT LINEAR REGULATOR 1 (LDO1) SPECIFICATION

Output Voltage		I _{OUT1} = 0 mA to 100 mA, 7 V < ASO_RAIL < 18 V	4.9	5	5.1	V
Dropout (ASO_RAIL - V _{OUT1})	V _{DR1}	I _{OUT1} = 100 mA (Note 7)			500	mV
Load Regulation		I _{OUT1} = 0 mA to 100 mA, VIN_B = 13.2 V		0	75	μV/mA
Line Regulation		I _{OUT1} = 1 mA, 7 V < ASO_RAIL < 18 V		0	2	mV/V
Output Current Limit			200			mA
Output Load Capacitance Range	Co	Output Capacitance for Stability	1.0		100	μF
Output Load Capacitance ESR Range (Notes 8 and 9)	ESRCo	Cap ESR for Stability	0.01		13	Ω
ΔV _{OUT1} (ASO Low to High Transient)		T _J = 25 °C, I _{OUT1} = 100 mA, I _{SYS} = 400 mA, C _{ASO_RAIL} = 1 μF, ESR _{Co} = 0.01 Ω, Co = 10 μF, VIN-A falling		70	100	± mV
ΔV _{OUT1} (ASO high to Low Transient)		T _J = 25 °C, I _{OUT1} = 100 mA, I _{SYS} = 400 mA, C _{ASO_RAIL} = 1 μF, ESR _{Co} = 0.01 Ω, Co = 10 μF, VIN-A rising		70	100	± mV
Power Supply Ripple Rejection (Note 8)	PSRR	VIN_B = 13.2 V, 0.5 V _{PP} , 100 Hz		60		dB
Startup Overshoot		I _{OUT1} = 0 mA to 100 mA			3	%

LOW DROP-OUT LINEAR REGULATOR 2 (LDO2) SPECIFICATION

Output Voltage		I _{OUT2} = 0 mA to 300 mA, 7 V < ASO_RAIL < 18 V	3.234	3.3	3.366	V
Dropout (ASO_RAIL - V _{OUT2})	V _{DR2}	I _{OUT2} = 300 mA (Note 7)			1.5	V
Load Regulation		I _{OUT2} = 0 mA to 300 mA, VIN_B = 13.2 V		0	66	μV/mA
Line Regulation		I _{OUT2} = 1 mA, 7 V < ASO_RAIL < 18 V		0	1.2	mV/V
Output Current Limit			400			mA
Output Load Capacitance Range	Co	Output Capacitance for Stability	1.0		100	μF
Output Load Capacitance ESR Range (Notes 8 and 9)	ESRCo	Maximum Cap ESR for stability	0.01		10	Ω
ΔV _{OUT2} (ASO Low to High Transient)		T _J = 25 °C, I _{OUT2} = 300 mA, I _{SYS} = 400 mA, C _{ASO_RAIL} = 1 μF, ESR _{Co} = 0.01 Ω, Co = 22 μF, VIN-A falling		30	66	± mV
ΔV _{OUT2} (ASO high to Low Transient)		T _J = 25 °C, I _{OUT2} = 300 mA, I _{SYS} = 400 mA, C _{ASO_RAIL} = 1 μF, ESR _{Co} = 0.01 Ω, Co = 22 μF, VIN-A rising		30	66	± mV
Power Supply Ripple Rejection (Note 8)	PSRR	VIN_B = 13.2 V, 0.5 V _{PP} , 100 Hz		60		dB
Startup Overshoot		I _{OUT2} = 0 mA to 300 mA			3	%

LOW DROP-OUT LINEAR REGULATOR 3 (LDO3) SPECIFICATION

Output Voltage	V _{OUT3}	I _{OUT3} = 0 mA to 400 mA, 7 V ≤ VIN_S3 ≤ 18 V	3.234	3.3	3.366	V
Dropout (VIN_S3 - V _{OUT3})	V _{DR3}	I _{OUT3} = 300 mA (Note 7)			1.5	V
Output Current Limit			400			mA
Load Regulation		I _{OUT3} = 0 mA to 300 mA, VIN_B = 13.2 V		0	66	μV/mA
Line Regulation		I _{OUT3} = 1 mA, 7 V ≤ VIN_S3 ≤ 18 V		0	1.2	mV/V

NCV8613B

ELECTRICAL CHARACTERISTICS (7 V < ASO_RAIL < 18 V, VIN-H = VIN-B ≥ ASO_RAIL, V_{PP} = 5 V, VIN_S3 tied to ASO_RAIL, VBATT_MON = 0 V, IGNIN = 0 V, I_{SYS} = 3 mA (Note 6)) Min/Max values are valid for the temperature range -40°C ≤ T_J ≤ 150 °C unless noted otherwise. Min/Max values are guaranteed by test, design or statistical correlation.

Parameter	Symbol	Conditions	Min	Typ	Max	Unit
-----------	--------	------------	-----	-----	-----	------

LOW DROP-OUT LINEAR REGULATOR 3 (LDO3) SPECIFICATION

Output Load Capacitance Range	Co	Output Capacitance for Stability	1.0		100	μF
Output Load Capacitance ESR Range (Notes 8 and 9)	ESRCo	Maximum Capacitance ESR for stability	0.01		12	Ω
ΔV _{OUT3} (ASO Low to High Transient)		T _J = 25 °C, I _{OUT3} = 300 mA, I _{SYS} = 400 mA, C _{ASO_RAIL} = 1 μF, ESR _{Co} = 0.01 Ω, Co = 47 μF, VIN-A falling		30	66	± mV
ΔV _{OUT3} (ASO high to Low Transient)		T _J = 25 °C, I _{OUT3} = 300 mA, I _{SYS} = 400 mA, C _{ASO_RAIL} = 1 μF, ESR _{Co} = 0.01 Ω, Co = 47 μF, VIN-A rising		30	66	± mV
Power Supply Ripple Rejection (Note 8)	PSRR	VIN_B = 13.2 V, 0.5 V _{PP} , 100 Hz		60		dB
Startup Overshoot		I _{OUT3} = 0 mA to 300 mA			3	%

7. Dropout voltage is measured when the output voltage has dropped 100 mV relative to the nominal value obtained with ASO_RAIL = VIN_S3 = 13.2 V.

8. Not tested in production. Limits are guaranteed by design.

9. Refer to CIRCUIT DESCRIPTION Section for Stability Consideration

ORDERING INFORMATION

Device	Conditions	Package	Shipping
NCV8613BMNR2G	No Enable, LDO2 Reset monitor	20 Lead DFN, 5x6 (Pb-Free)	2500 / Tape & Reel

NCV8613B

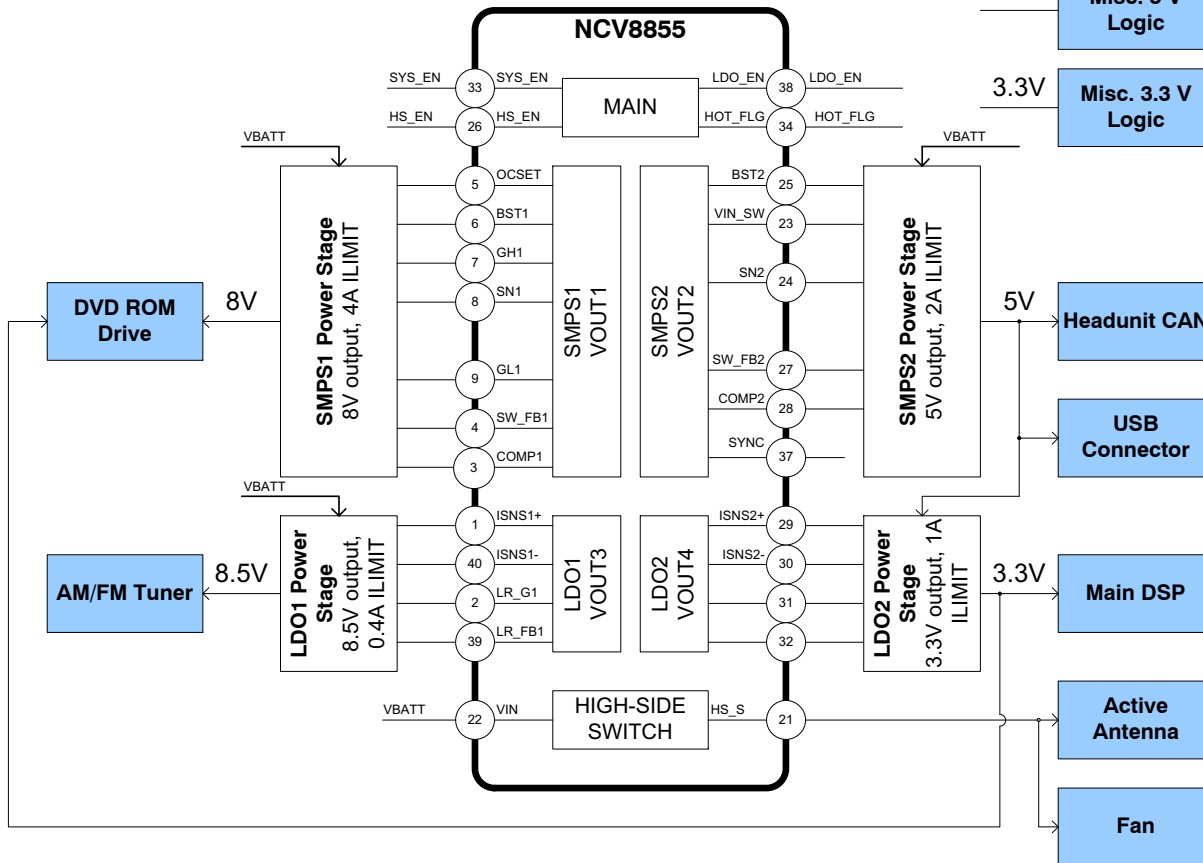
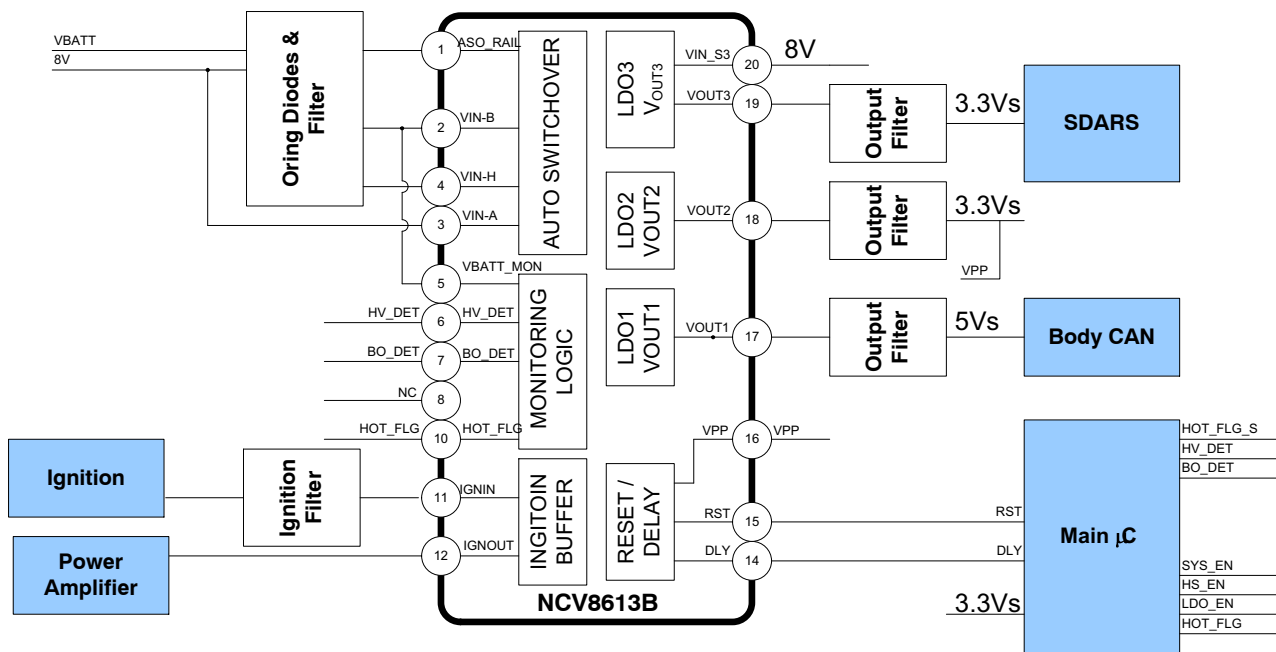

Figure 2. Automotive Radio System Block Diagram Example NCV8613B with NCV8855

CIRCUIT DESCRIPTION

Auto Switchover Circuitry

The auto switchover circuit is designed to insure continuous operation of the device, automatically switching the input voltage from the ASO_RAIL input, to the VIN-B input, to the VIN-H input depending on conditions. The primary input voltage pin is ASO_RAIL, which is driven from the 8 V supply. When this voltage is present it will drive the output voltages. Regardless of whether the 8 V supply is available, the reference and core functions of the device will be driven by the higher of VIN-B and VIN-H. The switchover control circuitry will be powered solely by the 8 V supply, via VIN-A.

When the 8 V supply is not present, the gates of the 2 P-FET switches will be pulled to ground, turning the switches on. In this condition, the VIN-B and VIN-H voltages will be diode or'ed, with the higher voltage powering the chip. The VIN-H voltage will be one diode lower than the VIN-B voltage, thereby forcing the VIN-B voltage to be dominant supply.

In the event that both the 8 V supply and the VIN-B supply are not present, the VIN-H supply will be powering the device. The VIN-H supply is then fed from a recommended 1000 μ F cap. The duration of VIN-H supply is dependent on output current. It is intended as protection against temporary loss of battery conditions.

In the event of a double battery, or prolonged high voltage condition on the battery line, a bleed transistor has been included on the VIN-H line. With the large hold-up cap on VIN-H, the voltage on that pin has the potential to remain in an elevated position for an extended period of time. The main result of this condition would be an Overvoltage Shutdown of the device. In order to avoid this condition, a transistor that is connected to the Overvoltage Shutdown signal is tied to the VIN-H line. This transistor will become active in a high voltage event, allowing the hold-up cap to discharge the excess voltage in a timely manner.

In the Block Diagram, Figure 1, C_{ASO_RAIL} is listed as a 1 μ F capacitor. It is required for proper operation of the device that C_{ASO_RAIL} is no larger than 1 μ F.

During a switchover event, a timer in the output stages prepares the regulator in anticipation of change in input voltage. The event results in a hitch in the output waveforms, as can be seen in Figure 3.

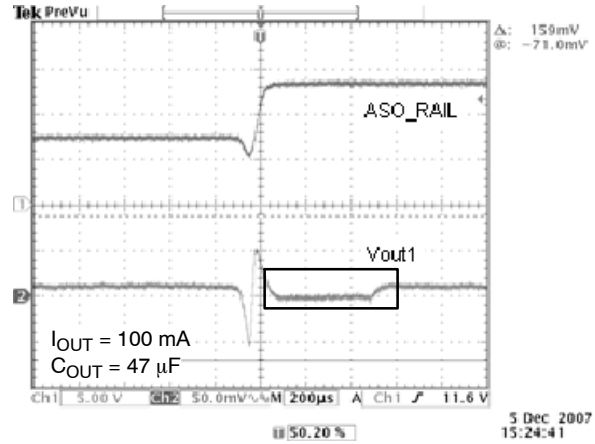

Figure 3. V_{OUTX} Response to ASO Switchover Event

VIN-B/VIN-H Minimum Operating Voltage

The internal reference and core functions are powered by either the VIN-B or VIN-H supply. The higher of the two voltages will dominate and power the reference. This provides quick circuit response on start-up, as well as a stable reference voltage. Since the VIN-B voltage will come up much more quickly than the VIN-H voltage, initially, the VIN-B voltage will be running the reference. In the case of any transient drops on VIN-B, the VIN-H supply, with its large hold-up capacitor, will then be the dominant voltage, and will be powering the reference.

For proper operation of the device, VIN-B or VIN-H must be at least 4.5 V. Below that voltage the reference will not operate properly, leading to incorrect functioning by the device. VIN-B or VIN-H must be greater than 4.5 V regardless of the voltage on the VIN-A pin.

Internal Soft-Start

The NCV8613B is equipped with an internal soft-start function. This function is included to limit inrush currents and overshoot of output voltages. The soft-start function applies to all 3 regulators.

The soft-start function kicks in for start up, start up via enable, start up after thermal shutdown, and startup after an over voltage condition.

LDO3 is not subject to soft-start under all conditions. The LDO3 output is not affected by overvoltage shutdown, and

therefore is not effected by the soft-start function upon the device's return from an over voltage condition. Also, when VIN_S3 is connected to an independent supply and the supply is made available after the soft-start function, LDO3 will not have an independent soft-start.

LDO1 Regulator

The LDO1 error amplifier compares the reference voltage to a sample of the output voltage (VOUT1) and drives the gate of an internal PFET. The reference is a bandgap design to give it a temperature-stable output.

LDO2 Regulator

The LDO2 error amplifier compares the reference voltage to a sample of the output voltage (VOUT2) and drives the gate of an internal PFET. The reference is a bandgap design to give it a temperature-stable output.

LDO3 Regulator

The LDO3 error amplifier compares the reference voltage to a sample of the output voltage (VOUT3) and drives the gate of an internal PFET. The reference is a bandgap design to give it a temperature-stable output

Stability Considerations

The output or compensation capacitors, COUTX help determine three main characteristics of a linear regulator: startup delay, load transient response and loop stability. The capacitor values and type should be based on cost, availability, size and temperature constraints. Tantalum, aluminum electrolytic, film, or ceramic capacitors are all acceptable solutions, however, attention must be paid to ESR constraints. The aluminum electrolytic capacitor is the least expensive solution, but, if the circuit operates at low temperatures (-25°C to -40°C), both the value and ESR of the capacitor will vary considerably. The capacitor manufacturer's data sheet usually provides this information. The value for each output capacitor COUTX shown in Figures 20 – 25 should work for most applications; however, it is not necessarily the optimized solution. Stability is guaranteed at the following values:

- COUT1 ≥ 47 μF, ESR ≤ 10 Ω
- COUT2 ≥ 47 μF, ESR ≤ 10 Ω
- COUT3 ≥ 47 μF, ESR ≤ 10 Ω

Actual limits are shown in graphs in the Typical Performance Characteristics section.

Thermal

As power in the NCV8613B increases, it might become necessary to provide some thermal relief. The maximum power dissipation supported by the device is dependent upon board design and layout. Mounting pad configuration on the PCB, the board material, and the ambient temperature affect the rate of junction temperature rise for the part. When the NCV8613B has good thermal conductivity through the PCB, the junction temperature will be relatively low with high power applications.

The maximum dissipation the NCV8613B can handle is given by:

$$P_{D(max)} = (T_{J(max)} - T_A) / R_{thJA}$$

See Figure 18 for R_{thJA} versus PCB Area.

R_{thJA} could be further decreased by using Multilayer PCB and/or if Air Flow is taken into account.

IGNOUT Circuitry

The IGNOUT pin is an open drain output Schmitt Trigger, externally pulled up to 3.3 V via a 10 kΩ resistor. The IGNOUT pin can be used to monitor the ignition signal of the vehicle, and send a signal to mute an audio amplifier during engine crank. The IGNIN pin is ESD protected, and can handle peak transients up to 45 V. An external diode is recommended to protect against negative voltage spikes.

The IGNOUT circuitry requires the device to be enabled for proper operation.

V_{PP} Function

The reset and warning circuits utilize a push-pull output stage. The high signal is provided by V_{PP}. V_{PP} is an externally fed signal that can be tied to an output, or tied to another regulated voltage signal, typically 5 V, but as low as 3.0 V. Under this setup, and any setup where LDO's 1-3 are tied to V_{PP}, loss of the V_{PP} signal can occur if the pull up voltage is reduced due to over current, thermal shutdown, or overvoltage conditions.

Reset Outputs

The Reset Output is used as the power on indicator to the Microcontroller. The NCV8613B Reset circuitry monitors the output on LDO2.

This signal indicates when the output voltage is suitable for reliable operation. It pulls low when the output is not considered to be suitable. The Reset circuitry utilizes a push pull output stage, with V_{PP} as the high signal. In the event of the part shutting down via Battery voltage or Enable, the Reset output will be pulled to ground.

The input and output conditions that control the Reset Output and the relative timing are illustrated in Figure 4, Reset Timing. Output voltage regulation must be maintained for the delay time before the reset output signals a valid condition. The delay for the reset output is defined as the amount of time it takes the timing capacitor on the delay pin to charge from a residual voltage of 0 V to the Delay timing threshold voltage V_D of 2 V. The charging current for this is I_D of 5 μA. By using typical IC parameters with a 10 nF capacitor on the Delay Pin, the following time delay is derived:

$$t_{RD} = C_D * V_{DU} / I_D$$

$$t_{RD} = 10 \text{ nF} * (2 \text{ V}) / (5 \text{ μA}) = 4 \text{ ms}$$

Other time delays can be obtained by changing the C_D capacitor value. The Delay Time can be reduced by decreasing the capacitance of C_D. Using the formula above, delay can be reduced as desired. Leaving the Delay Pin open

is not desirable as it can result in unwanted signals being coupled onto the pin.

VBATT_MON and Warning Flags

The NCV8613B is equipped with High Voltage Detection, Brown Out Detection, and High Temperature Detection circuitry. The Overvoltage Shutdown, High Voltage, and Brown Out Detection circuitry are all run off the VBATT_MON input. If this functionality is not desired, grounding of the VBATT_MON pin will turn off the functions.

The HV_DET and BO_DET signals are in a high impedance state until the VBATT_MON circuitry reaches its minimum operating voltage, typically 1.0 V to 2.5 V. At that point the BO_DET signal will be held low, while the HV_DET signal will go high. The BO_DET signal will go high once the VBATT_MON signal reaches the Brown Out Threshold, typically 7 V to 8 V. The BO_DET signal will stay high until the VBATT_MON voltage drops below the Brown Out Threshold. The HV_DET signal will stay high until the VBATT_MON voltage rises above the HV_DET threshold, typically 16.2 V to 17.8 V. The HV_DET signal will reassert high once the HV_DET signal crosses the HV_DET threshold going low.

The NCV8613B is also equipped with a Hot Flag pin which indicates when the junction temperature is approaching thermal shutdown. The Hot Flag signal will remain high as long as the junction temperature is below the Hot flag threshold, typically 140°C to 160°C. This pin is intended as a warning that the junction temperature is approaching the Thermal Shutdown threshold, which is

typically 160°C to 180°C. The Hot Flag signal will remain low until the junction temperature drops below the Hot Flag threshold.

The Hot_Flag circuitry does not run off the VBATT_MON Pin, and can not be disabled by grounding VBATT_MON.

Each of the three warning circuits utilizes a push-pull output stage. The high signal is provided by V_{PP}. When V_{PP} is tied to an output of the NCV8613B, the signal will go low if the corresponding output shuts down due to a fault condition.

Overvoltage Shutdown

The NCV8613B is equipped with overvoltage shutdown (OVS) functionality. The OVS is designed to turn on when the VBATT_MON signal crosses 17 V. If the VBATT_MON pin is tied to ground, the OVS functionality will be disabled.

When OVS is triggered, LDO1 and LDO2 will both be shut down. LDO3 is run off a separate input voltage line, VIN_S3, and will not shutdown in this condition. Once the OVS condition has passed, LDO1 and LDO2 will both turn back on.

The VIN-H line is equipped with a bleed transistor to prevent a continued OVS condition on the chip once the high battery condition has subsided. This transistor is needed to discharge the high voltage from the VIN-H hold-up capacitor. This transistor will only turn on when an OVS is detected on-chip, and will turn off as soon as the OVS condition is no longer detected by the chip.

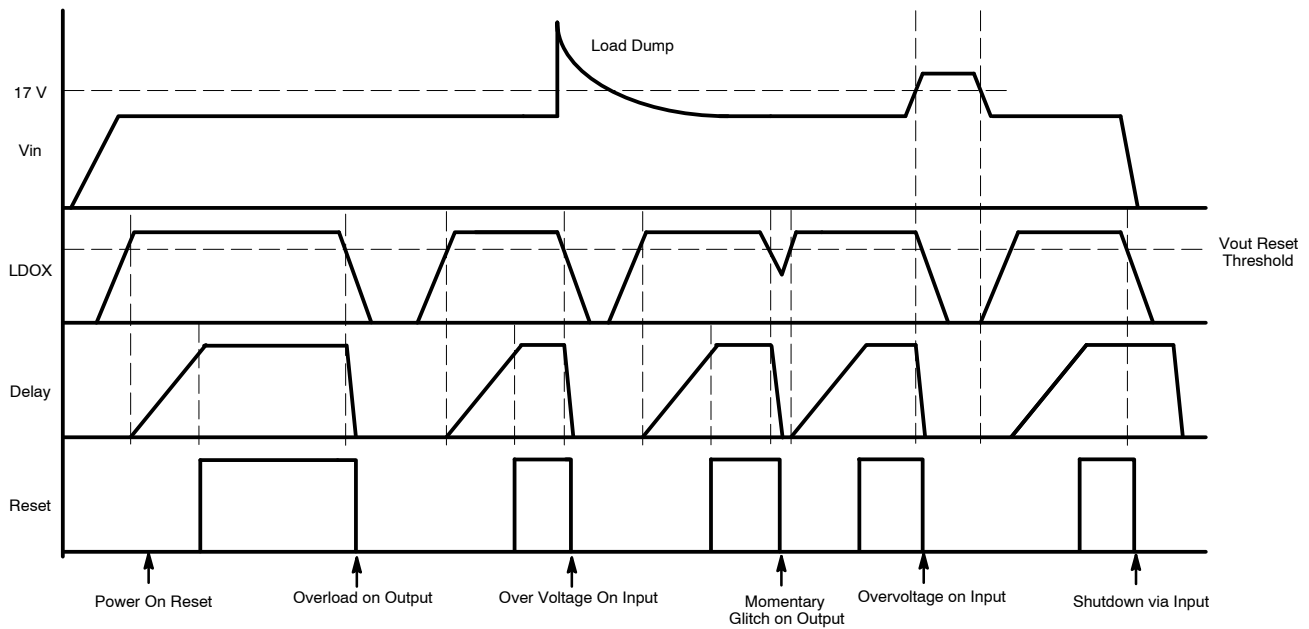

Figure 4. NCV8613B Reset Timing Diagram

NCV8613B

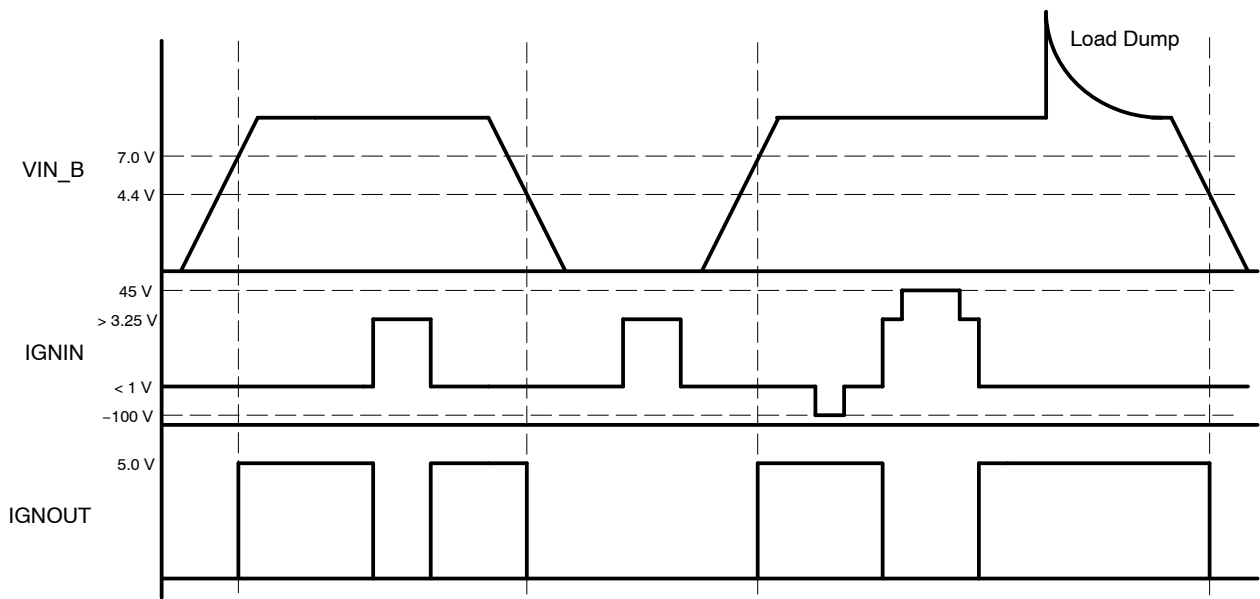

Figure 5. IGNOUT Timing Diagram

NCV8613B

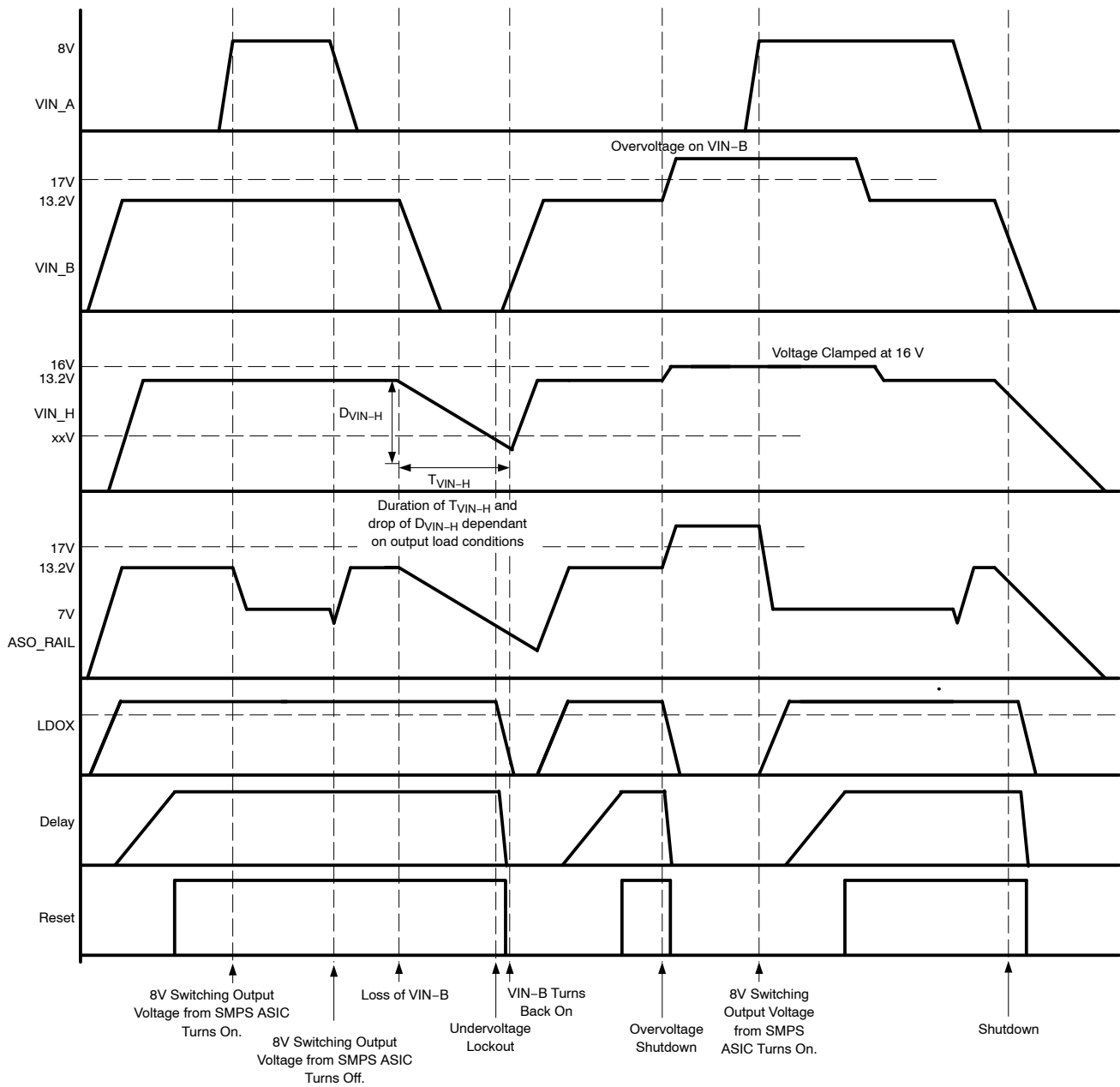

Figure 6. Auto Switchover Circuit Timing Diagram VBATTMON Connected to ASO_RAIL

NCV8613B

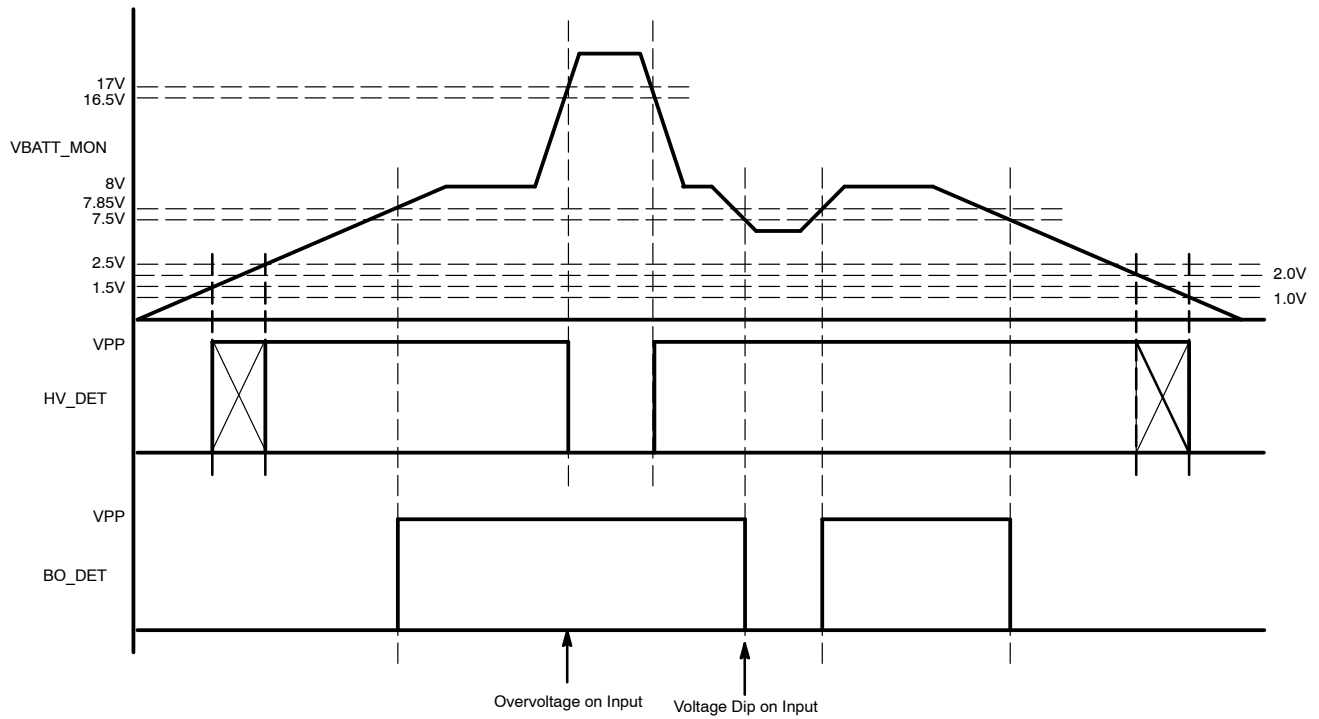

Figure 7. Warning Circuitry Timing Diagram

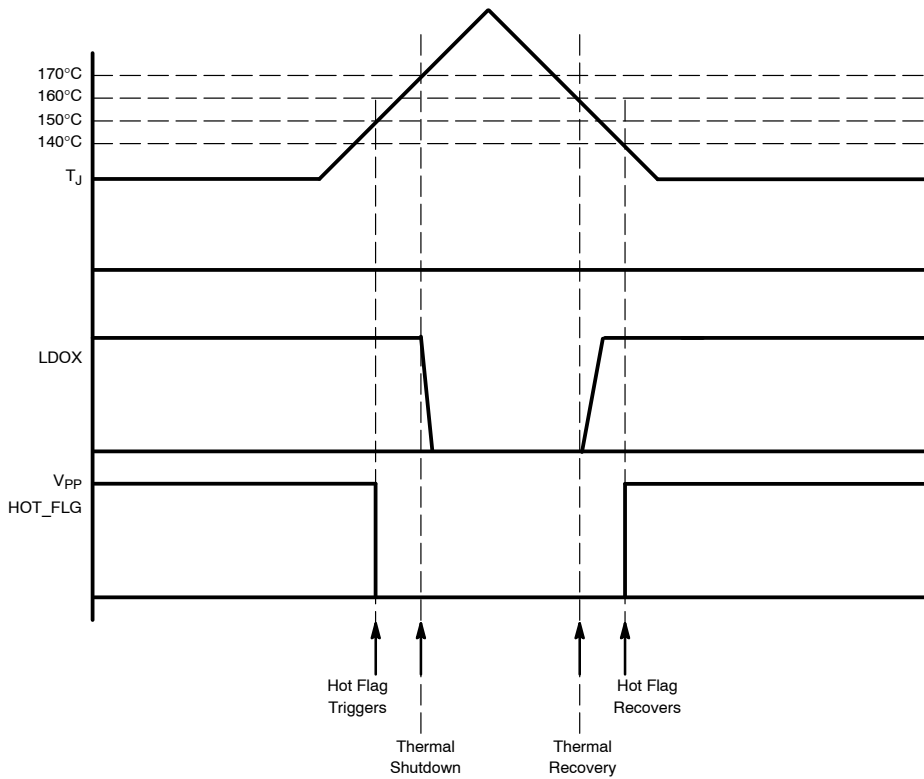

Figure 8. Thermal Shutdown Timing Diagram

NCV8613B

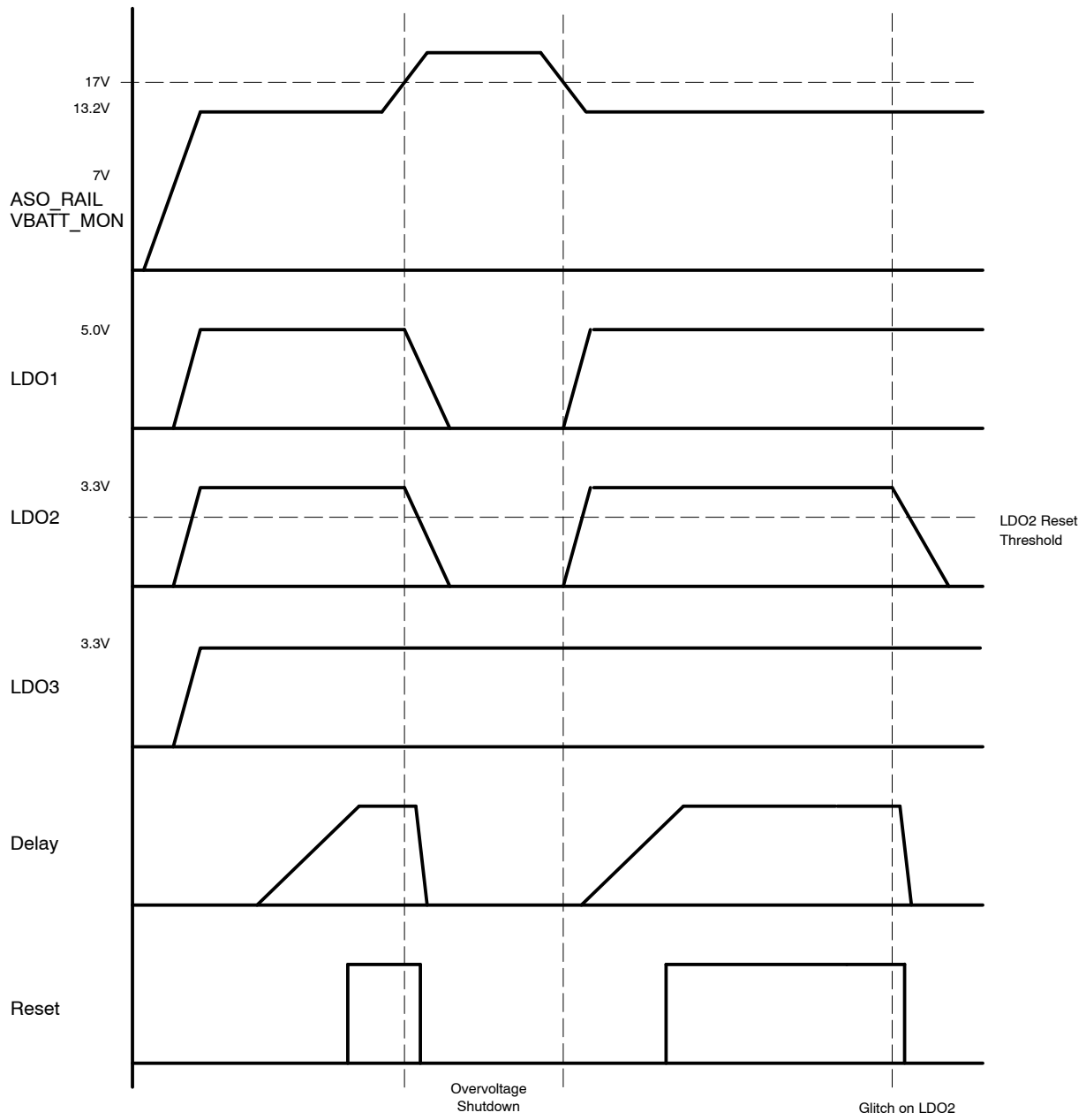

Figure 9. NCV8613B Regulator Output Timing Diagram– VIN_S3 Tied to ASO_RAIL

NCV8613B

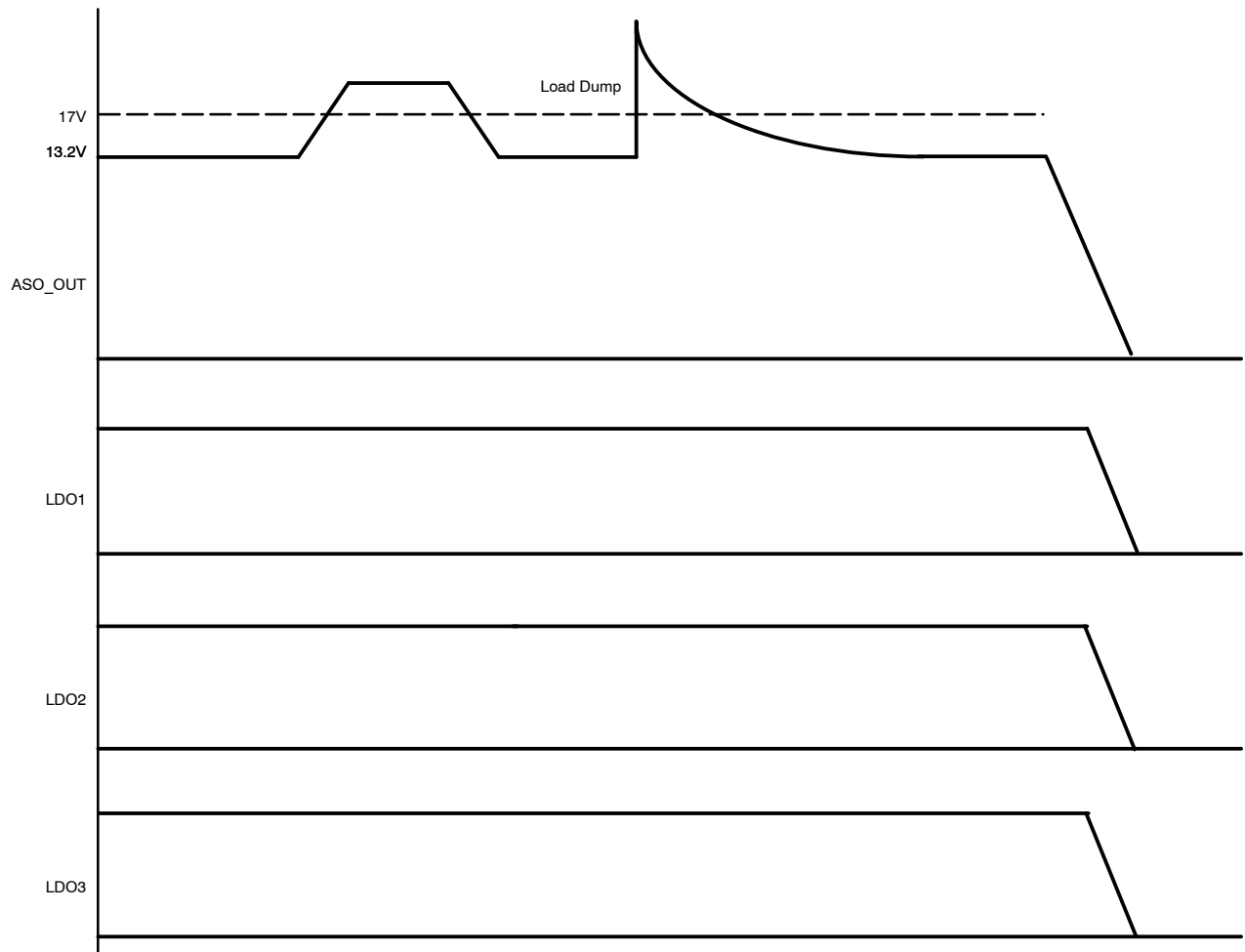

Figure 10. NCV8613B Regulator Output Timing Diagram- VBATT_MON Grounded

NCV8613B

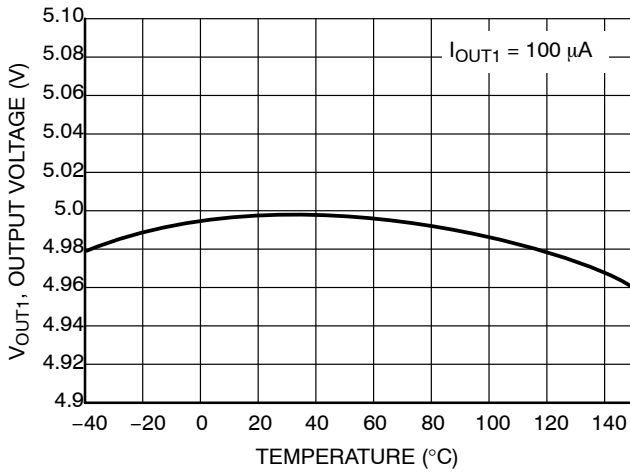

Figure 11. Output Voltage LDO1 vs Temperature

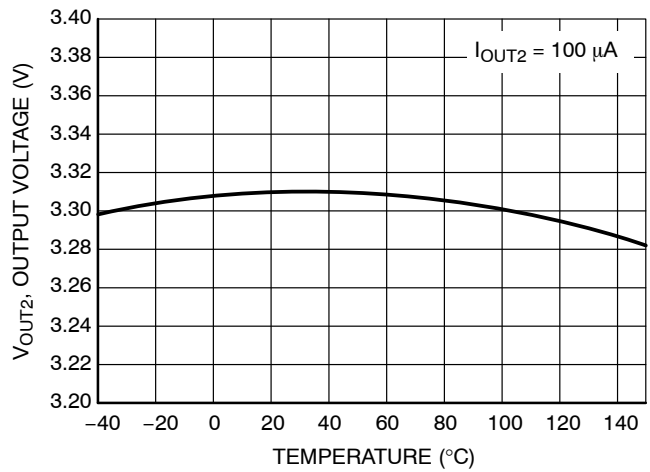

Figure 12. Output Voltage LDO2 vs Temperature

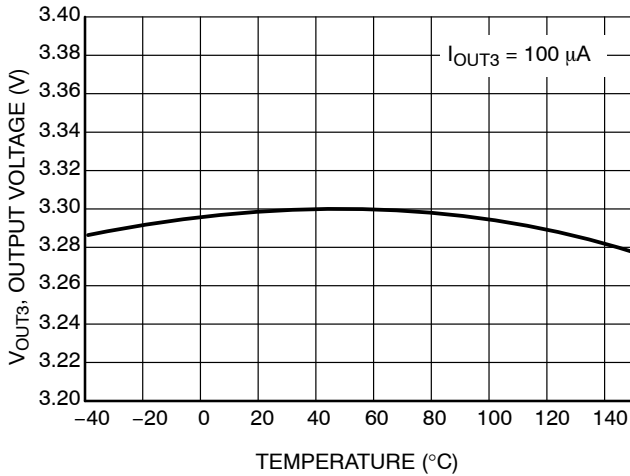

Figure 13. Output Voltage LDO3 vs Temperature

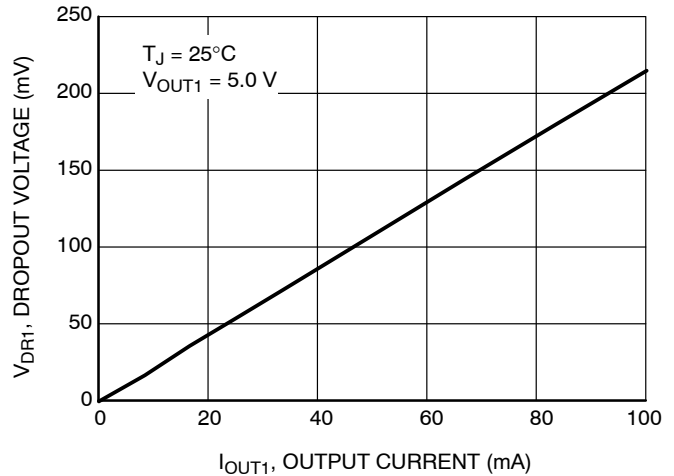

Figure 14. Dropout LDO1 vs Output Current

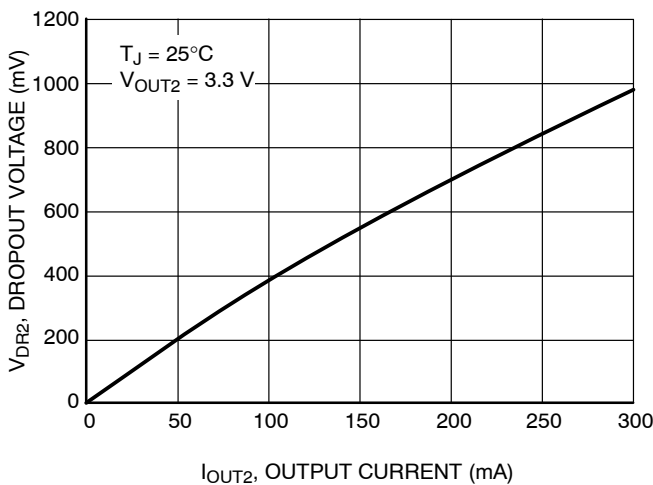

Figure 15. Dropout LDO2 vs Output Current

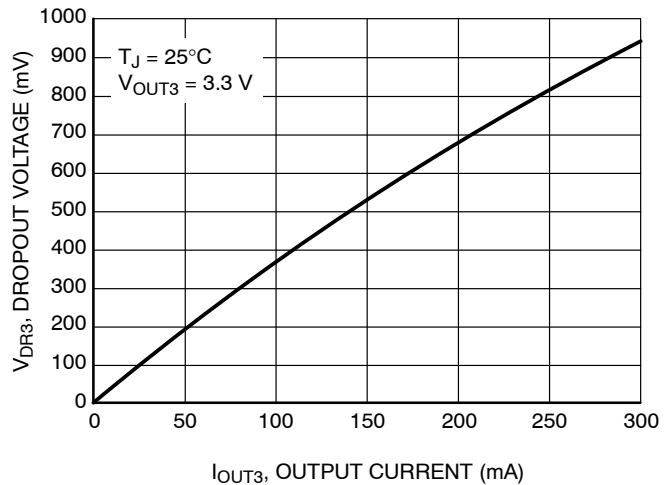

Figure 16. Dropout LDO3 vs Output Current

NCV8613B

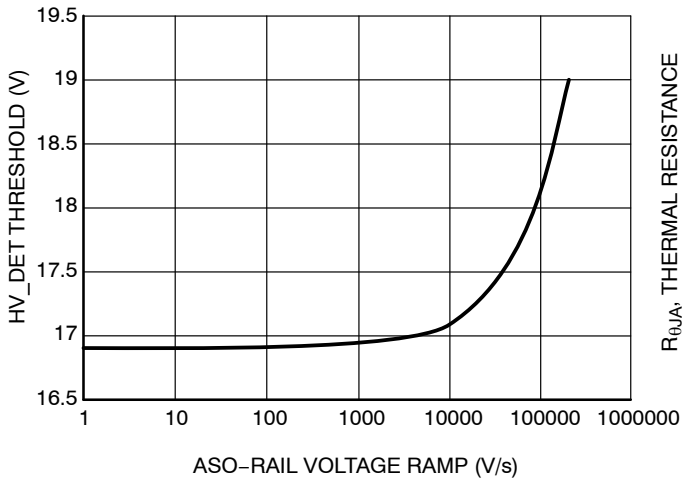

Figure 17. HV-DET Threshold vs. dV/dt

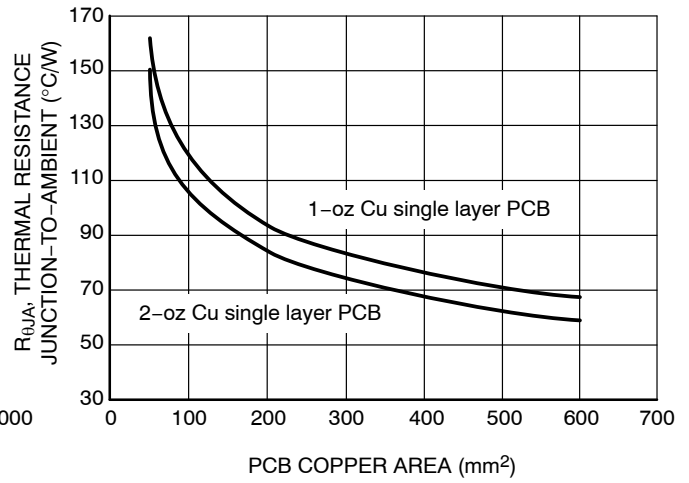

Figure 18. $R_{\theta JA}$ vs. Copper Area

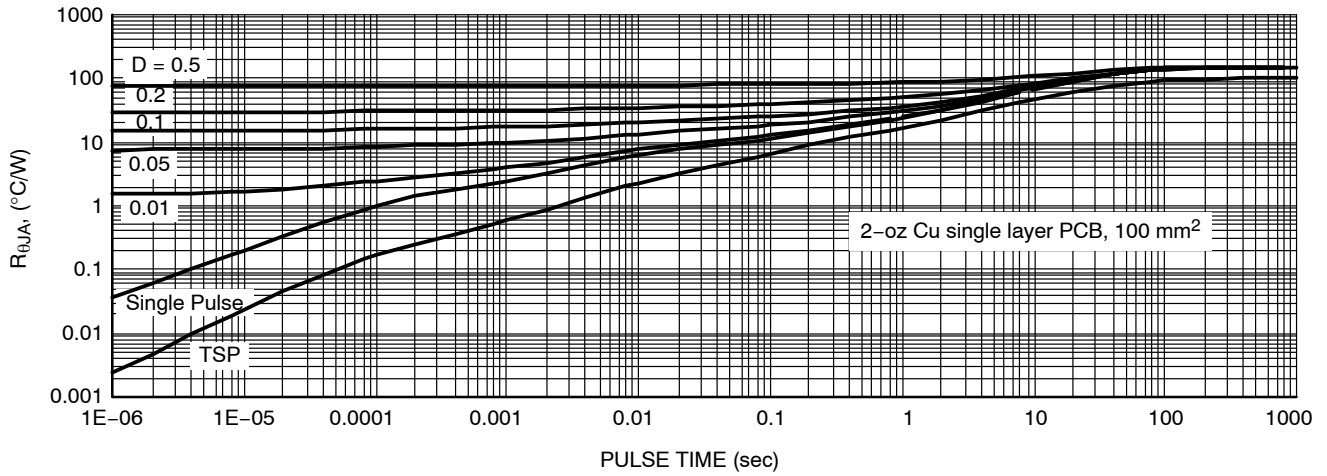

Figure 19. $R_{\theta JA}$ vs. Duty Cycle

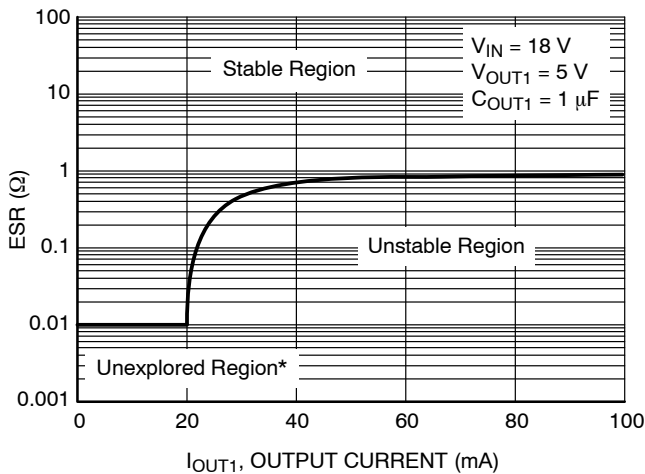

Figure 20. C_{OUT1} ESR Stability Region – 1 μ F

*The min specified ESR is based on Murata's capacitor GRM31CR60J476ME19 used in measurement. The true min ESR limit might be lower than shown.

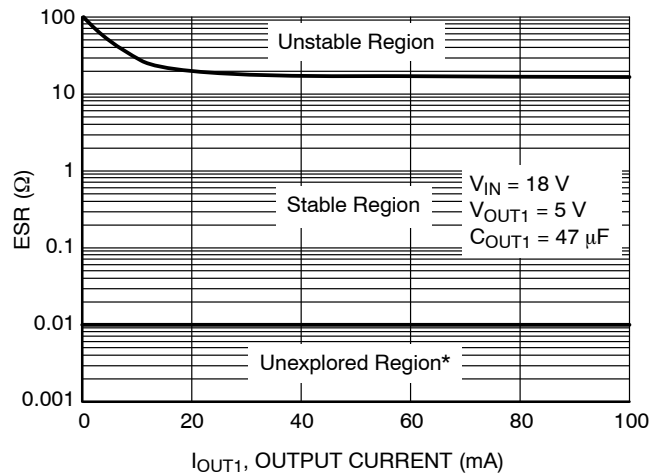

Figure 21. C_{OUT1} ESR Stability Region – 47 μ F

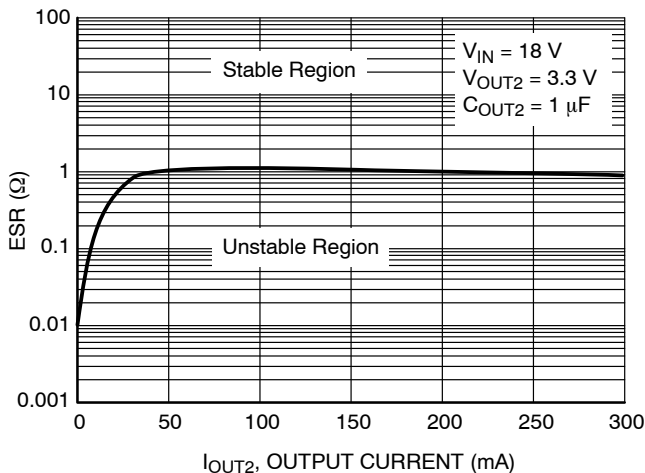

Figure 22. C_{OUT2} ESR Stability Region – 1 μ F

*The min specified ESR is based on Murata's capacitor GRM31CR60J476ME19 used in measurement. The true min ESR limit might be lower than shown.

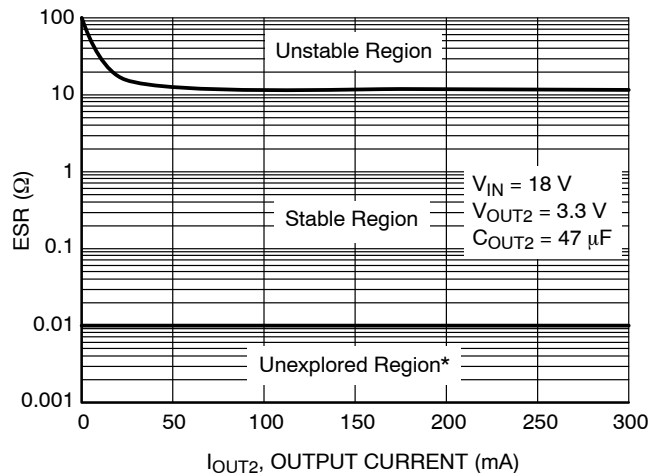

Figure 23. C_{OUT2} ESR Stability Region – 47 μ F

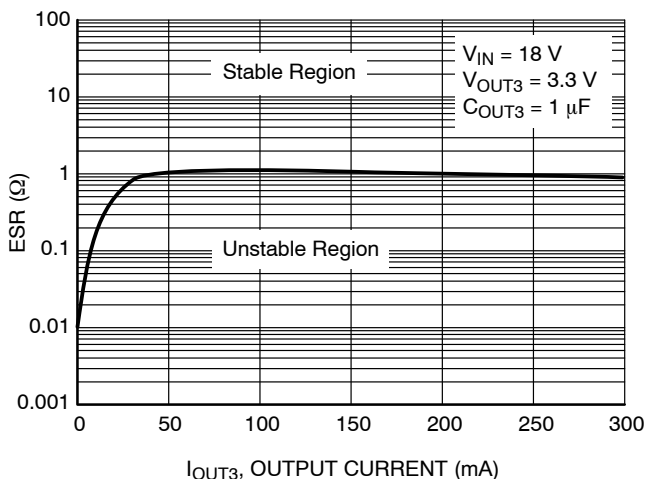

Figure 24. C_{OUT3} ESR Stability Region – 1 μ F

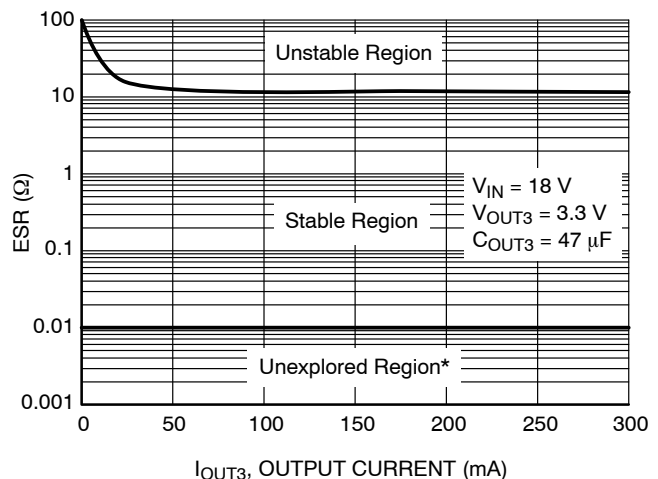

Figure 25. C_{OUT3} ESR Stability Region – 47 μ F

NCV8613B

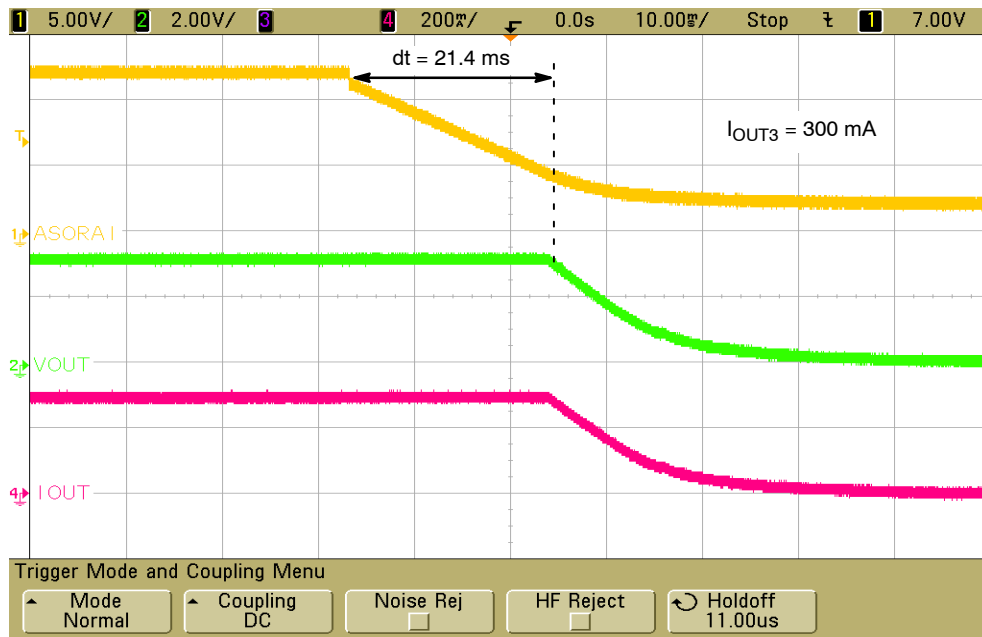

Figure 26. Output Response of LDO3 to Loss of Vin-B



Figure 27. Output Response of LDO2 to Loss of Vin-B

NCV8613B

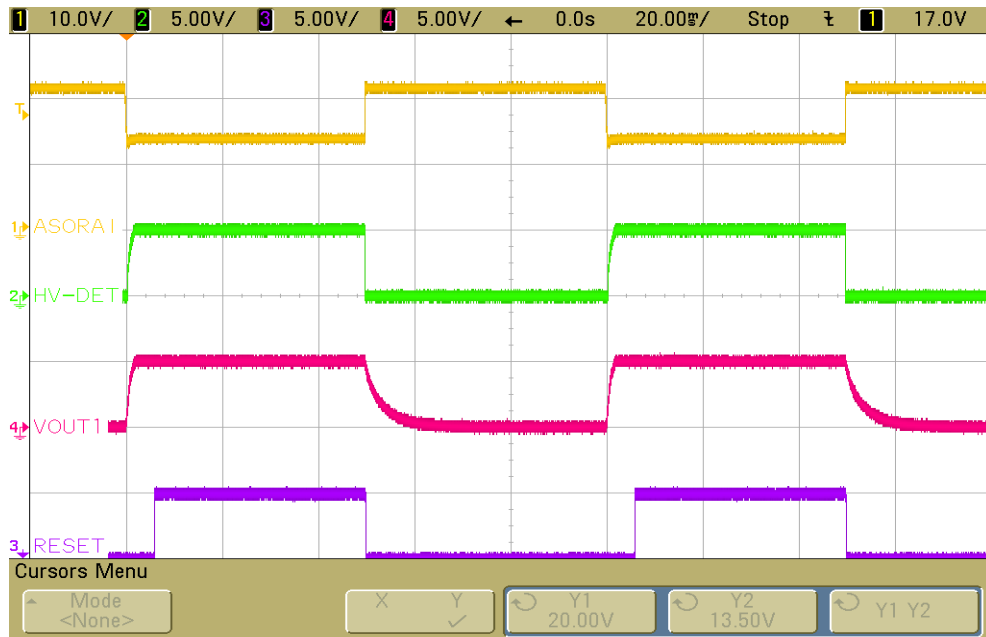

Figure 28. HV-DET Response to High Voltage – VBAT-MON tied to ASO-RAIL

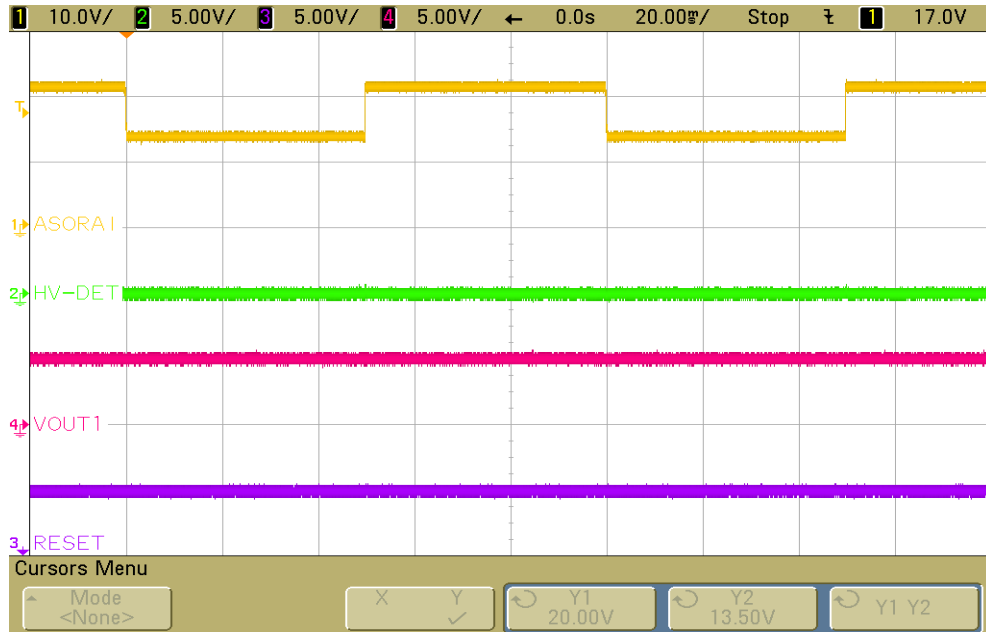

Figure 29. HV-DET Response to High Voltage – VBAT-MON Left Open

NCV8613B

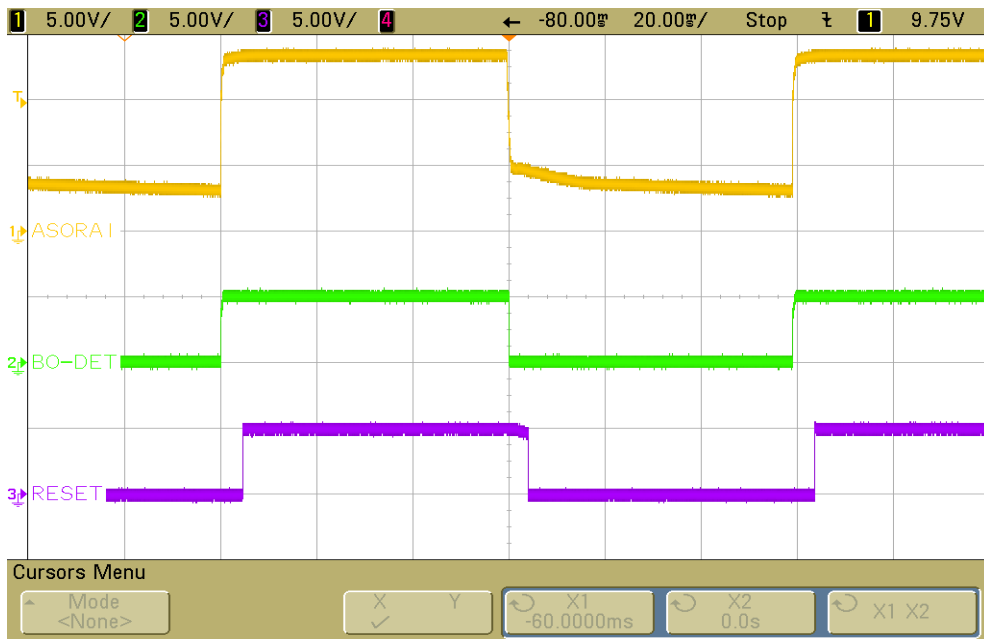

Figure 30. BO-DET Response to LOW Voltage – VBAT-MON tied to ASO-RAIL



Figure 31. BO-DET Response to LOW Voltage – VBAT-MON Left Open

NCV8613B

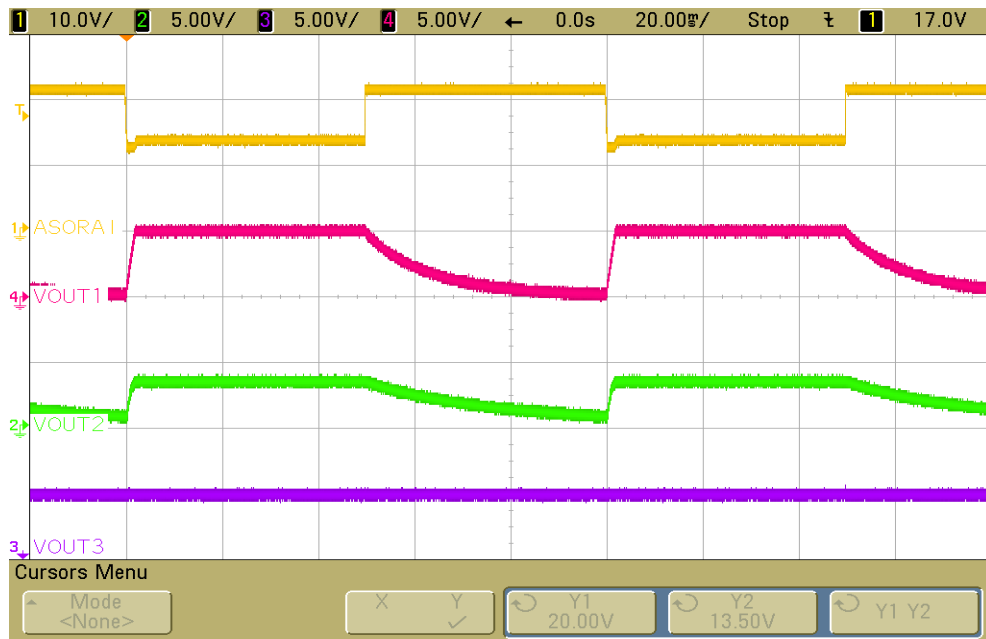

Figure 32. Output Response to OVS - VBAT-MON tied to ASO-RAIL

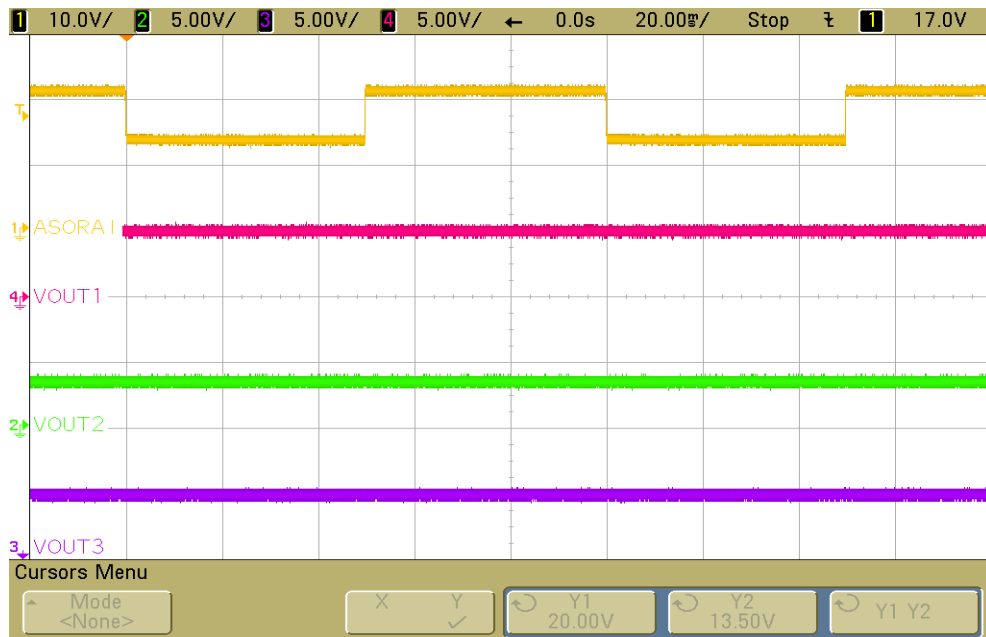
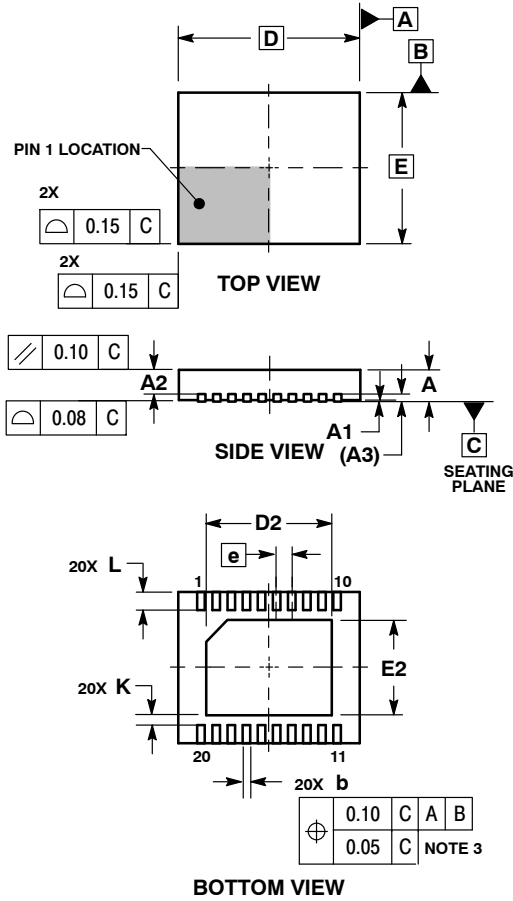

Figure 33. Output Response to OVS - VBAT-MON Left Open

NCV8613B

PACKAGE DIMENSIONS

DFN20
CASE 505AB-01
ISSUE B



NOTES:

1. DIMENSIONS AND TOLERANCING PER ASME Y14.5M, 1994.
2. DIMENSIONS IN MILLIMETERS.
3. DIMENSION b APPLIES TO PLATED TERMINALS AND IS MEASURED BETWEEN 0.25 AND 0.30 MM FROM TERMINAL
4. COPLANARITY APPLIES TO THE EXPOSED PAD AS WELL AS THE TERMINALS.

MILLIMETERS		
DIM	MIN	MAX
A	0.80	1.00
A1	0.00	0.05
A2	0.65	0.75
A3	0.20 REF	
b	0.20	0.30
D	6.00 BSC	
D2	3.98	4.28
E	5.00 BSC	
E2	2.98	3.28
e	0.50 BSC	
K	0.20	---
L	0.50	0.60

SOLDERING FOOTPRINT*

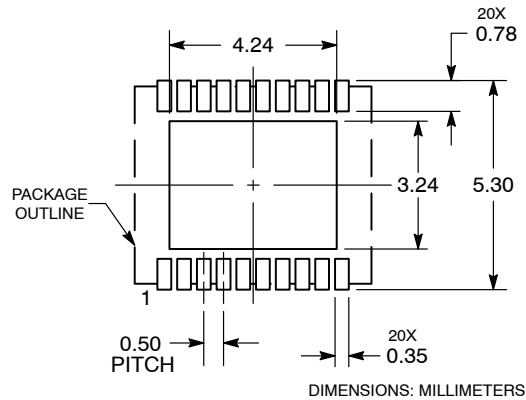

*For additional information on our Pb-Free strategy and soldering details, please download the ON Semiconductor Soldering and Mounting Techniques Reference Manual, SOLDERRM/D.

ON Semiconductor and are registered trademarks of Semiconductor Components Industries, LLC (SCILLC). SCILLC reserves the right to make changes without further notice to any products herein. SCILLC makes no warranty, representation or guarantee regarding the suitability of its products for any particular purpose, nor does SCILLC assume any liability arising out of the application or use of any product or circuit, and specifically disclaims any and all liability, including without limitation special, consequential or incidental damages. "Typical" parameters which may be provided in SCILLC data sheets and/or specifications can and do vary in different applications and actual performance may vary over time. All operating parameters, including "Typicals" must be validated for each customer application by customer's technical experts. SCILLC does not convey any license under its patent rights nor the rights of others. SCILLC products are not designed, intended, or authorized for use as components in systems intended for surgical implant into the body, or other applications intended to support or sustain life, or for any other application in which the failure of the SCILLC product could create a situation where personal injury or death may occur. Should Buyer purchase or use SCILLC products for any such unintended or unauthorized application, Buyer shall indemnify and hold SCILLC and its officers, employees, subsidiaries, affiliates, and distributors harmless against all claims, costs, damages, and expenses, and reasonable attorney fees arising out of, directly or indirectly, any claim of personal injury or death associated with such unintended or unauthorized use, even if such claim alleges that SCILLC was negligent regarding the design or manufacture of the part. SCILLC is an Equal Opportunity/Affirmative Action Employer. This literature is subject to all applicable copyright laws and is not for resale in any manner.

PUBLICATION ORDERING INFORMATION

LITERATURE FULFILLMENT:

Literature Distribution Center for ON Semiconductor
P.O. Box 5163, Denver, Colorado 80217 USA
Phone: 303-675-2175 or 800-344-3860 Toll Free USA/Canada
Fax: 303-675-2176 or 800-344-3867 Toll Free USA/Canada
Email: orderlit@onsemi.com

N. American Technical Support: 800-282-9855 Toll Free
USA/Canada
Europe, Middle East and Africa Technical Support:
Phone: 421 33 790 2910
Japan Customer Focus Center
Phone: 81-3-5773-3850

ON Semiconductor Website: www.onsemi.com

Order Literature: <http://www.onsemi.com/orderlit>

For additional information, please contact your local Sales Representative

NCV8613B/D