



VN5770AKP-E

Quad smart power solid state relay for complete H-bridge configurations

Features

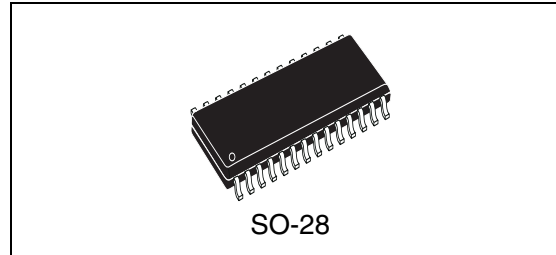
Type	R _{DS(on)}	I _{OUT} (typ)	V _{CC}
VN5770AKP-E	280 mΩ ⁽¹⁾	8.5 A	36 V

1. Total resistance of one side in bridge configuration

- ECOPACK®: lead free and RoHS compliant
- Automotive Grade: compliance with AEC guidelines
- General features
 - Inrush current management by active power limitation on the high-side switches
 - Very low standby current
 - Very low electromagnetic susceptibility
 - Compliance with European directive 2002/95/EC
- Protection
 - High-side drivers undervoltage shutdown
 - Overvoltage clamp
 - Output current limitation
 - High and low-side overtemperature shutdown
 - Short circuit protection
 - ESD protection
- Diagnostic functions
 - Proportional load current sense
 - Thermal shutdown indication on both the high and low-side switches

Applications

- DC motor driving in full or half bridge configuration
- All types of resistive, inductive and capacitive loads



Description

The VN5770AKP-E is a device formed by three monolithic chips housed in a standard SO-28 package: a double high-side and two low-side switches. The double high-side is made using STMicroelectronics™ VIPower™ M0-5 technology, while the low-side switches are fully protected VIPower™ M0-3 OMNIFET II. This device is suitable to drive a DC motor in a bridge configuration as well as to be used as a quad switch for any low voltage application.

The dual high-side switches integrate built in non latching thermal shutdown with thermal hysteresis. An output current limiter protects the device in overload condition. In the case of long overload duration, the device limits the dissipated power to a safe level up to thermal shutdown intervention. An analog current sense pin delivers a current proportional to the load current (according to a known ratio) and indicates overtemperature shutdown of the relevant high-side switch through a voltage flag.

The low-side switches have built in non latching thermal shutdown with thermal hysteresis, linear current limitation and overvoltage clamping.

Fault feedback for overtemperature shutdown of the low-side switch is indicated by the relevant input pin current consumption going up to the fault sink current flag.

Contents

1	Block diagram and pin descriptions	5
2	Absolute maximum ratings	7
2.1	Absolute maximum ratings	7
3	Electrical characteristics	9
3.1	Electrical characteristics for dual high-side switch	9
3.2	Electrical characteristics curves for dual high-side switch	13
3.3	Electrical characteristics for low-side switches	15
3.4	Electrical characteristics curves for low-side switches	17
4	Application information	20
4.1	Maximum demagnetization energy ($V_{CC} = 13.5 \text{ V}$)	23
5	Package and thermal data	24
5.1	SO-28 thermal data	24
6	Package and packing information	29
6.1	ECOPACK® packages	29
6.2	SO-28 package information	29
6.3	SO-28 packing information	31
7	Order codes	32
8	Revision history	33

List of tables

Table 1.	Pin descriptions	6
Table 2.	Thermal data.	7
Table 3.	Dual high-side switch	7
Table 4.	Low-side switch	8
Table 5.	Power section	9
Table 6.	Switching ($V_{CC} = 13\text{ V}$)	9
Table 7.	Logic input	10
Table 8.	Protection and diagnostics	10
Table 9.	Current sense ($8\text{ V} < V_{CC} < 16\text{ V}$)	11
Table 10.	Truth table.	12
Table 11.	Off.	15
Table 12.	On.	15
Table 13.	Dynamic ($T_j = 25^\circ\text{C}$, unless otherwise specified)	15
Table 14.	Switching ($T_j = 25^\circ\text{C}$, unless otherwise specified)	15
Table 15.	Source drain diode	16
Table 16.	Protection and diagnostics ($-40^\circ\text{C} < T_j < 150^\circ\text{C}$, unless otherwise specified)	16
Table 17.	Thermal calculations in clockwise and anti-clockwise operation in steady-state mode	25
Table 18.	Thermal resistances definitions	25
Table 19.	Single pulse thermal impedance definitions	25
Table 20.	Thermal calculations in transient mode	26
Table 21.	Thermal parameters	28
Table 22.	SO-28 mechanical data	29
Table 23.	Device summary	32
Table 24.	Document revision history	33

List of figures

Figure 1.	Block diagram	5
Figure 2.	Configuration diagram (top view)	6
Figure 3.	Switching time waveforms	11
Figure 4.	Output voltage drop limitation	12
Figure 5.	Current sense delay characteristics	12
Figure 6.	Off-state output current	13
Figure 7.	High level input current	13
Figure 8.	Input clamp voltage	13
Figure 9.	Input low level	13
Figure 10.	Input high level	13
Figure 11.	Input hysteresis voltage	13
Figure 12.	On-state resistance vs T_{case}	14
Figure 13.	On-state resistance vs V_{CC}	14
Figure 14.	Undervoltage shutdown	14
Figure 15.	Turn-on voltage slope	14
Figure 16.	I_{LIMH} vs T_{case}	14
Figure 17.	Turn-off voltage slope	14
Figure 18.	Static drain source on resistance	17
Figure 19.	Derating curve	17
Figure 20.	Transconductance	17
Figure 21.	Transfer characteristics	17
Figure 22.	Input voltage vs input charge	17
Figure 23.	Capacitance variations	17
Figure 24.	Output characteristics	18
Figure 25.	Step response current limit	18
Figure 26.	Source-drain diode forward characteristics	18
Figure 27.	Static drain-source on resistance vs I_D	18
Figure 28.	Static drain-source on resistance vs input voltage (part 1)	18
Figure 29.	Static drain-source on resistance vs input voltage (part 2)	18
Figure 30.	Normalized input threshold voltage vs temperature	19
Figure 31.	Normalized on resistance vs temperature	19
Figure 32.	Current limit vs junction temperature	19
Figure 33.	Typical application schematic	20
Figure 34.	Recommended motor operation	21
Figure 35.	Waveforms	22
Figure 36.	Maximum turn off current versus load inductance	23
Figure 37.	SO-28 PC board	24
Figure 38.	Chipset configuration	24
Figure 39.	Auto and mutual $R_{thj-amb}$ vs PCB copper area in open box free air condition	25
Figure 40.	SO-28 HSD thermal impedance junction ambient single pulse	26
Figure 41.	SO-28 LSD thermal impedance junction ambient single pulse	27
Figure 42.	Thermal fitting model of an H-bridge in SO-28	27
Figure 43.	SO-28 package dimensions	30
Figure 44.	SO-28 tube shipment (no suffix)	31
Figure 45.	Tape and reel shipment (suffix "TR")	31

1 Block diagram and pin descriptions

Figure 1. Block diagram

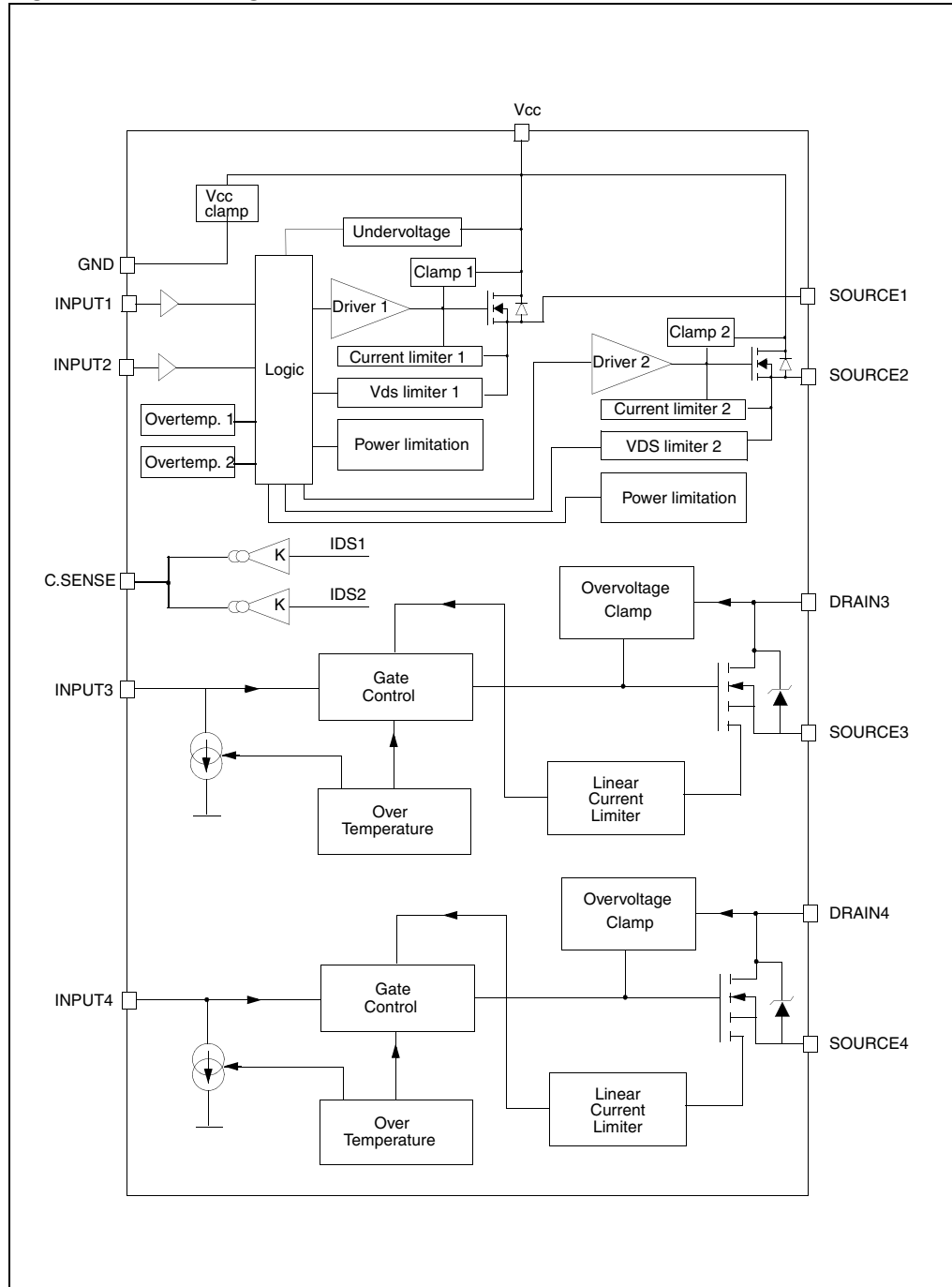
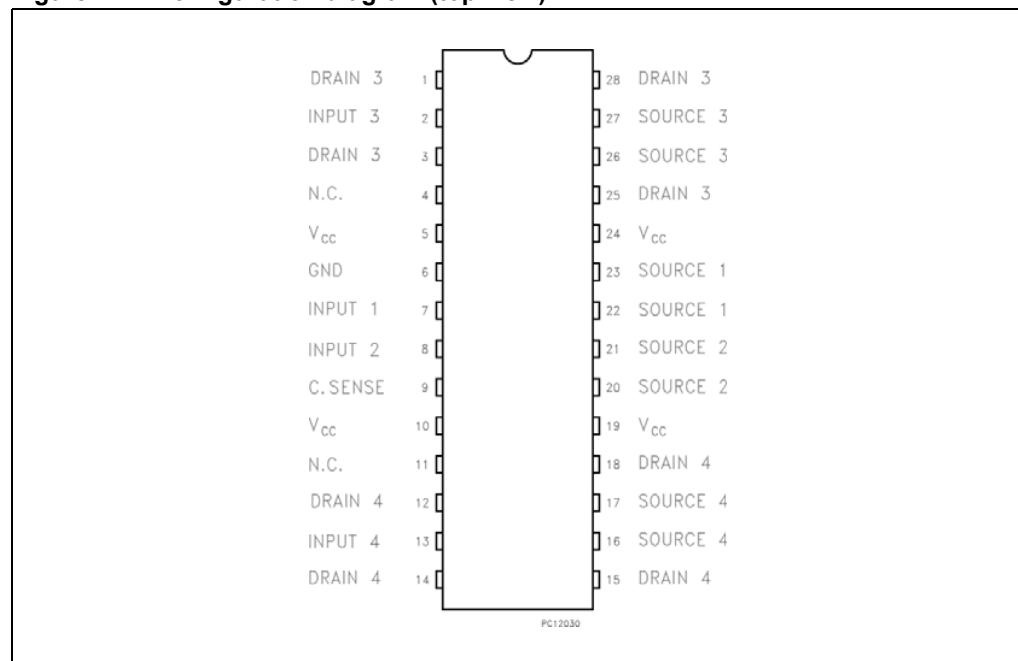


Table 1. Pin descriptions

No	Name	Function
1, 3, 25, 28	DRAIN 3	Drain of switch 3 (low-side switch)
2	INPUT 3	Input of switch 3 (low-side switch)
4, 11	N.C.	Not connected
5, 10, 19, 24	V _{CC}	Drain of switches 1 and 2 (high-side switches) and power supply voltage
6	GND	Ground of switches 1 and 2 (high-side switches)
7	INPUT 1	Input of switch 1 (high-side switches)
8	INPUT 2	Input of switch 2 (high-side switch)
9	CURRENT SENSE	Analog current sense pin, delivers a current proportional to the load current
12, 14, 15, 18	DRAIN 4	Drain of switch 4 (low-side switch)
13	INPUT 4	Input of switch 4 (low-side switch)
16, 17	SOURCE 4	Source of switch 4 (low-side switch)
20, 21	SOURCE 2	Source of switch 2 (high-side switch)
22, 23	SOURCE 1	Source of switch 1 (high-side switch)
26, 27	SOURCE 3	Source of switch 3 (low-side switch)

Figure 2. Configuration diagram (top view)

2 Absolute maximum ratings

Stressing the device above the rating listed in the “Absolute maximum ratings” table may cause permanent damage to the device. These are stress ratings only and operation of the device at these or any other conditions above those indicated in the Operating sections of this specification is not implied. Exposure to the conditions in [Section 2.1: Absolute maximum ratings](#) for extended periods may affect device reliability. Refer also to the STMicroelectronics SURE Program and other relevant quality document.

2.1 Absolute maximum ratings

Table 2. Thermal data

Symbol	Parameter	Max value	Unit
$R_{thj-case}$	Thermal resistance junction-lead (high-side switch)	10	°C/W
$R_{thj-case}$	Thermal resistance junction-lead (low-side switch)	7	°C/W
$R_{thj-amb}$	Thermal resistance junction-ambient.	See Figure 38	°C/W

Table 3. Dual high-side switch

Symbol	Parameter	Value	Unit
V_{CC}	DC supply voltage	41	V
$-V_{CC}$	Reverse DC supply voltage	0.3	V
$-I_{GND}$	DC reverse ground pin current	200	mA
I_{OUT}	DC output current	Internally limited	A
$-I_{OUT}$	Reverse DC output current	-12	A
I_{IN}	DC input current	-1 to 10	mA
I_{CSD}	DC current sense disable input current	-1 to 10	mA
V_{CSense}	Current sense maximum voltage	$V_{CC}-41$ $+V_{CC}$	V V
E_{MAX}	Maximum switching energy (single pulse) ($L = 3.7$ mH; $R_L = 0$ Ω ; $V_{bat} = 13.5$ V; $T_{jstart} = 150$ °C; $I_{OUT} = I_{limL}(Typ.)$)	32	mJ
V_{ESD}	Electrostatic discharge (Human Body Model: $R = 1.5$ K Ω ; $C = 100$ pF) - INPUT - CURRENT SENSE - OUTPUT - V_{CC}	4000 2000 5000 5000	V V V V
V_{ESD}	Charge device model (CDM-AEC-Q100-011)	750	V
T_j	Junction operating temperature	-40 to 150	°C
T_{stg}	Storage temperature	-55 to 150	°C

Table 4. Low-side switch

Symbol	Parameter	Value	Unit
V_{DSn}	Drain-source voltage ($V_{INn} = 0$ V)	Internally clamped	V
V_{INn}	Input voltage	Internally clamped	V
I_{INn}	Input current	+/-20	mA
$R_{IN\ MINn}$	Minimum input series impedance	220	Ω
I_{Dn}	Drain current	Internally Limited	A
I_{Rn}	Reverse DC output current	-12	A
V_{ESD1}	Electrostatic discharge ($R = 1.5$ K Ω , $C = 100$ pF)	4000	V
V_{ESD2}	Electrostatic discharge on output pins only ($R = 330$ Ω , $C = 150$ pF)	16500	V
P_{tot}	Total dissipation at $T_c = 25$ °C	4	W
T_j	Operating junction temperature	Internally limited	°C
T_c	Case operating temperature	Internally limited	°C
T_{stg}	Storage temperature	-55 to 150	°C

3 Electrical characteristics

3.1 Electrical characteristics for dual high-side switch

Values specified in this section are for $8\text{ V} < V_{CC} < 36\text{ V}$; $-40\text{ °C} < T_j < 150\text{ °C}$, unless otherwise specified (for each channel).

Table 5. Power section

Symbol	Parameter	Test conditions	Min.	Typ.	Max.	Unit
V_{CC}	Operating supply voltage		4.5	13	36	V
V_{USD}	Undervoltage shutdown			3.5	4.5	V
$V_{USDhyst}$	Undervoltage shutdown hysteresis			0.5		V
R_{ON}	On-state resistance	$I_{OUT} = 3\text{ A}$; $T_j = 25\text{ °C}$		160		m Ω
		$I_{OUT} = 3\text{ A}$; $T_j = 150\text{ °C}$			320	m Ω
		$I_{OUT} = 3\text{ A}$; $V_{CC} = 5\text{ V}$; $T_j = 25\text{ °C}$			210	m Ω
V_{clamp}	Clamp Voltage	$I_S = 20\text{ mA}$	41	46	52	V
I_S	Supply current	Off-state; $V_{CC} = 13\text{ V}$; $T_j = 25\text{ °C}$; $V_{IN} = V_{OUT} = V_{SENSE} = 0\text{ V}$		2 ⁽¹⁾	5 ⁽¹⁾	μA
		On-state; $V_{CC} = 13\text{ V}$; $V_{IN} = 5\text{ V}$; $I_{OUT} = 0\text{ A}$		3	6	mA
$I_{L(off)}$	Off-state output current ⁽²⁾	$V_{IN} = V_{OUT} = 0\text{ V}$; $V_{CC} = 13\text{ V}$; $T_j = 25\text{ °C}$	0		3	μA
		$V_{IN} = V_{OUT} = 0\text{ V}$; $V_{CC} = 13\text{ V}$; $T_j = 125\text{ °C}$	0		5	μA
V_F	Output - V_{CC} diode voltage ⁽²⁾	$-I_{OUT} = 3\text{ A}$; $T_j = 150\text{ °C}$			0.7	V

1. PowerMOS leakage included

2. For each channel

Table 6. Switching ($V_{CC} = 13\text{ V}$)

Symbol	Parameter	Test conditions	Min.	Typ.	Max.	Unit
$t_{d(on)}$	Turn-on delay time	$R_L = 4.3\ \Omega$ (see Figure 3)	—	15	—	μs
$t_{d(off)}$	Turn-off delay time	$R_L = 4.3\ \Omega$ (see Figure 3)	—	10	—	μs
$(dV_{OUT}/dt)_{on}$	Turn-on voltage slope	$R_L = 4.3\ \Omega$	—	See Figure 15	—	V/ μs
$(dV_{OUT}/dt)_{off}$	Turn-off voltage slope	$R_L = 4.3\ \Omega$	—	See Figure 17	—	V/ μs
W_{ON}	Switching energy losses during t_{won}	$R_L = 4.3\ \Omega$ (see Figure 3)	—	0.16	—	mJ
W_{OFF}	Switching energy losses during t_{woff}	$R_L = 4.3\ \Omega$ (see Figure 3)	—	0.08	—	mJ

Table 7. Logic input

Symbol	Parameter	Test conditions	Min.	Typ.	Max.	Unit
V_{IL}	Input low level voltage				0.9	V
I_{IL}	Low level input current	$V_{IN} = 0.9\text{ V}$	1			μA
V_{IH}	Input high level voltage		2.1			V
I_{IH}	High level input current	$V_{IN} = 2.1\text{ V}$			10	μA
$V_{I(hyst)}$	Input hysteresis voltage		0.25			V
V_{ICL}	Input clamp voltage	$I_{IN} = 1\text{ mA}$	5.5		7	V
		$I_{IN} = -1\text{ mA}$		-0.7		V

Table 8. Protection and diagnostics⁽¹⁾

Symbol	Parameter	Test conditions	Min.	Typ.	Max.	Unit
I_{limH}	DC Short circuit current	$V_{CC} = 13\text{ V}$	6	8.5	12	A
		$5\text{ V} < V_{CC} < 36\text{ V}$			12	A
I_{limL}	Short circuit current during thermal cycling	$V_{CC} = 13\text{ V}; T_R < T_j < T_{TSD}$		3.5		A
T_{TSD}	Shutdown temperature		150	175	200	$^{\circ}\text{C}$
T_R	Reset temperature		$T_{RS} + 1$	$T_{RS} + 5$		$^{\circ}\text{C}$
T_{RS}	Thermal reset of STATUS		135			$^{\circ}\text{C}$
T_{HYST}	Thermal hysteresis ($T_{TSD} - T_R$)			7		$^{\circ}\text{C}$
V_{DEMAG}	Turn-off output voltage clamp	$I_{OUT} = 1\text{ A}; V_{IN} = 0;$ $L = 20\text{ mH}$	$V_{CC} - 41$	$V_{CC} - 46$	$V_{CC} - 52$	V
V_{ON}	Output voltage drop limitation	$I_{OUT} = 0.03\text{ A};$ $T_j = -40\text{ }^{\circ}\text{C}$ to $150\text{ }^{\circ}\text{C}$ (see Figure 4)		25		mV

1. To ensure long term reliability under heavy overload or short circuit conditions, protection and related diagnostic signals must be used together with a proper software strategy. If the device is subjected to abnormal conditions, this software must limit the duration and number of activation cycles

Table 9. Current sense (8 V V_{CC} <math>< 16V</math>)

Symbol	Parameter	Test conditions	Min.	Typ.	Max.	Unit
K_0	I_{OUT}/I_{SENSE}	$I_{OUT} = 0.08\text{ A}$; $V_{SENSE} = 0.5\text{ V}$; $T_j = -40\text{ }^\circ\text{C}$ to $50\text{ }^\circ\text{C}$	850	1450	2120	
K_1	I_{OUT}/I_{SENSE}	$I_{OUT} = 0.35\text{ A}$; $V_{SENSE} = 0.5\text{ V}$; $T_j = -40\text{ }^\circ\text{C}$ to $150\text{ }^\circ\text{C}$ $T_j = 25\text{ }^\circ\text{C}$ to $150\text{ }^\circ\text{C}$	840 980	1360 1360	2000 1740	
K_2	I_{OUT}/I_{SENSE}	$I_{OUT} = 3\text{ A}$; $V_{SENSE} = 4\text{ V}$; $T_j = -40\text{ }^\circ\text{C}$ to $150\text{ }^\circ\text{C}$	1200	1270	1350	
K_3	I_{OUT}/I_{SENSE}	$I_{OUT} = 4\text{ A}$; $V_{SENSE} = 4\text{ V}$; $T_j = -40\text{ }^\circ\text{C}$ to $150\text{ }^\circ\text{C}$	1200	1270	1350	
I_{SENSE0}	Analog sense current	$I_{OUT} = 0\text{ A}$; $V_{SENSE} = 0\text{ V}$; $V_{IN} = 0\text{ V}$; $T_j = -40\text{ }^\circ\text{C}$ to $150\text{ }^\circ\text{C}$ $V_{IN} = 5\text{ V}$; $T_j = -40\text{ }^\circ\text{C}$ to $150\text{ }^\circ\text{C}$	0 0		1 2	μA μA
V_{SENSE}	Max analog sense output voltage	$I_{OUT} = 5\text{ A}$; $R_{SENSE} = 3.9\text{ K}\Omega$	5			V
V_{SENSEH}	Analog sense output voltage in over temperature condition	$V_{CC} = 13\text{ V}$; $R_{SENSE} = 3.9\text{ K}\Omega$		9		V
I_{SENSEH}	Analog sense output current in over temperature condition	$V_{CC} = 13\text{ V}$		8		mA
$t_{DSENSE2H}$	Delay response time from rising edge of INPUT pin	$V_{SENSE} < 4\text{ V}$, $0.35\text{ A} < I_{OUT} < 5\text{ A}$ $I_{SENSE} = 90\%$ of $I_{SENSE\text{ max}}$ (see Figure 5)		70	300	μs
$t_{DSENSE2L}$	Delay response time from falling edge of INPUT pin	$V_{SENSE} < 4\text{ V}$, $0.35\text{ A} < I_{OUT} < 5\text{ A}$ $I_{SENSE} = 10\%$ of $I_{SENSE\text{ max}}$ (see Figure 5)		100	250	μs

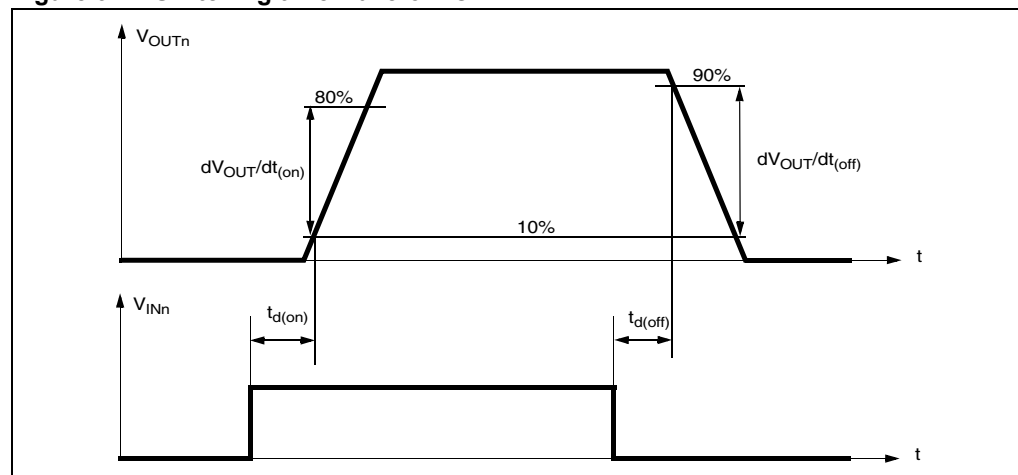
Figure 3. Switching time waveforms

Figure 4. Output voltage drop limitation

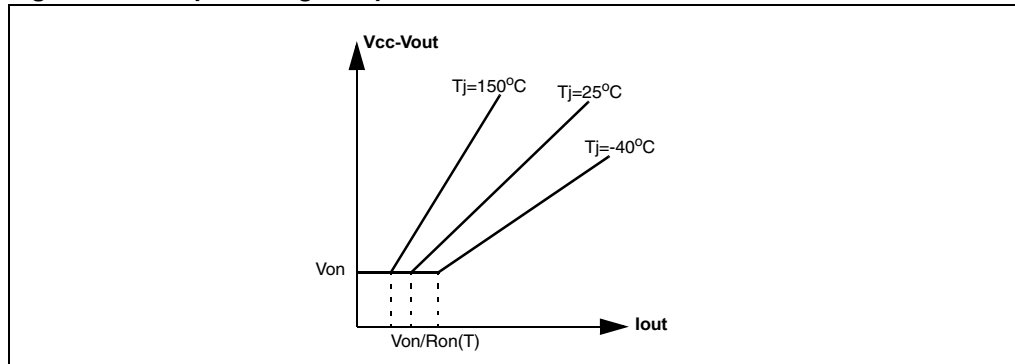


Table 10. Truth table

Conditions	Input	Output	Sense
Normal operation	L	L	0
	H	H	Nominal
Overtemperature	L	L	0
	H	L	V_{SENSEH}
Undervoltage	L	L	0
	H	L	0
Short circuit to GND	L	L	0
	H	L	0
Short circuit to V_{CC}	L	H	0
	H	H	< Nominal
Negative output voltage clamp	L	L	0

Figure 5. Current sense delay characteristics



3.2 Electrical characteristics curves for dual high-side switch

Figure 6. Off-state output current

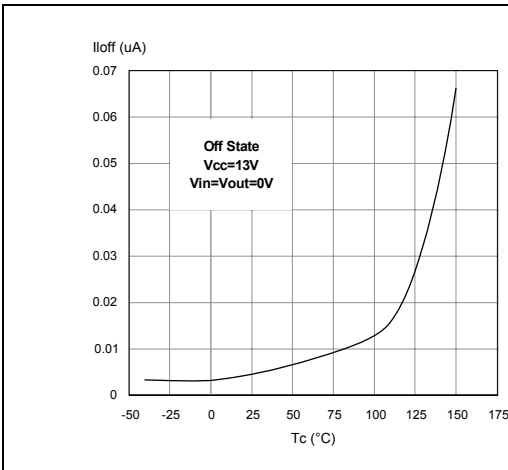


Figure 7. High level input current

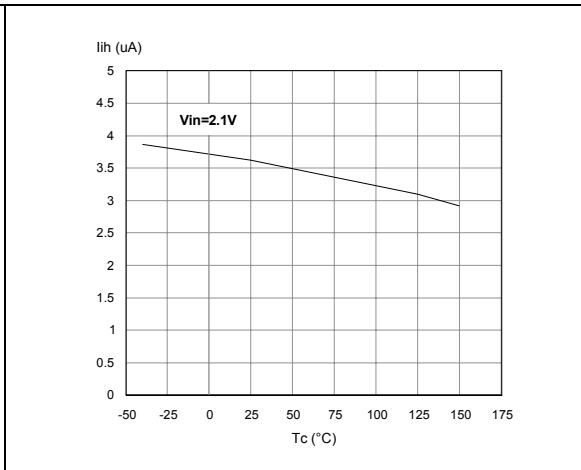


Figure 8. Input clamp voltage

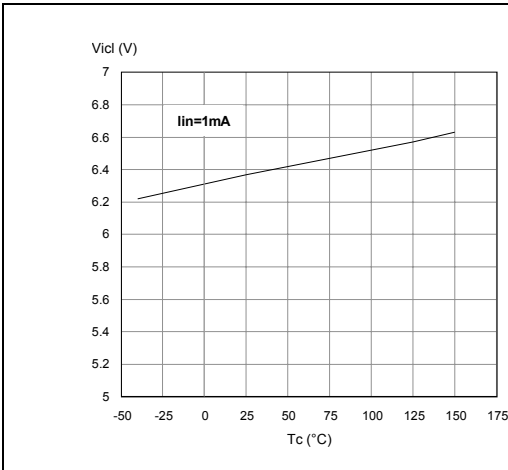


Figure 9. Input low level

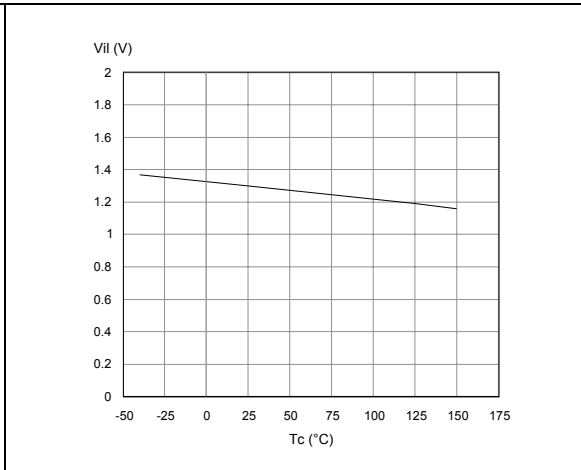


Figure 10. Input high level

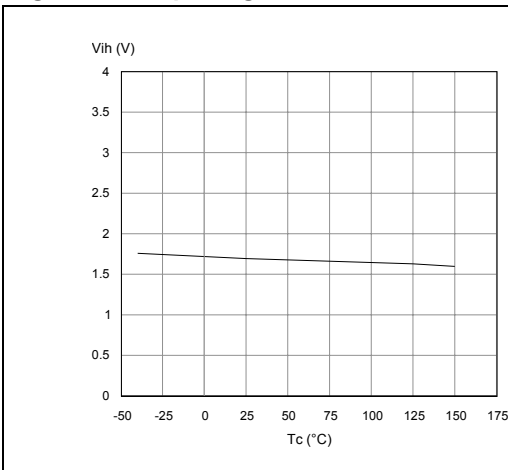


Figure 11. Input hysteresis voltage

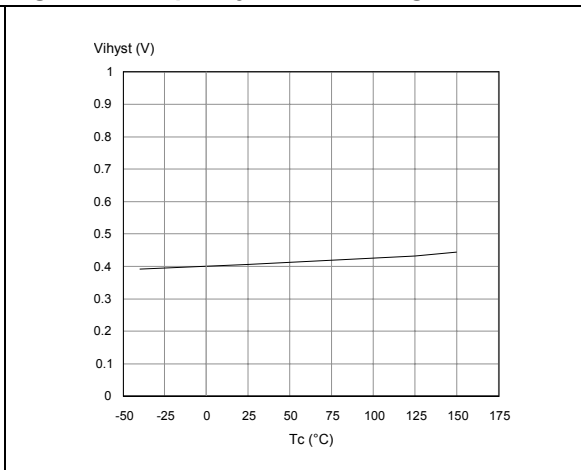


Figure 12. On-state resistance vs T_{case}

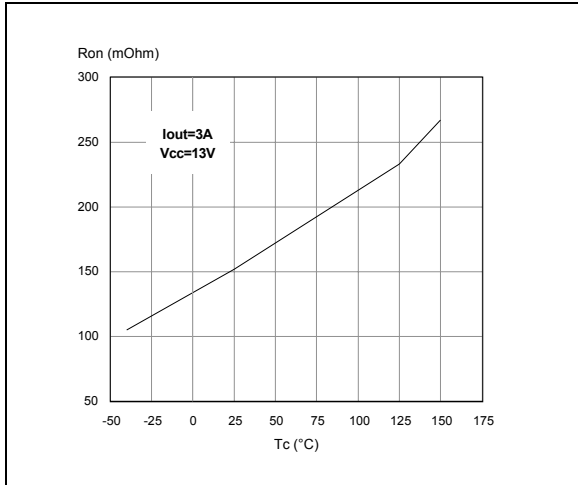


Figure 13. On-state resistance vs V_{CC}

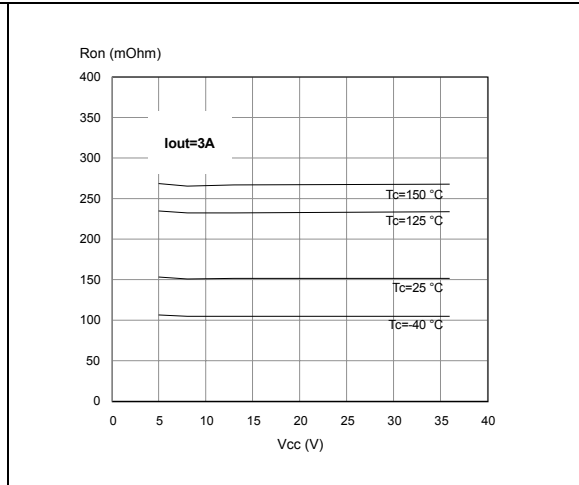


Figure 14. Undervoltage shutdown

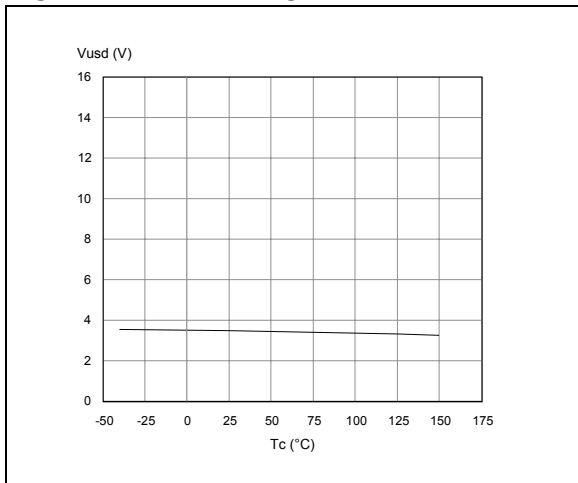


Figure 15. Turn-on voltage slope

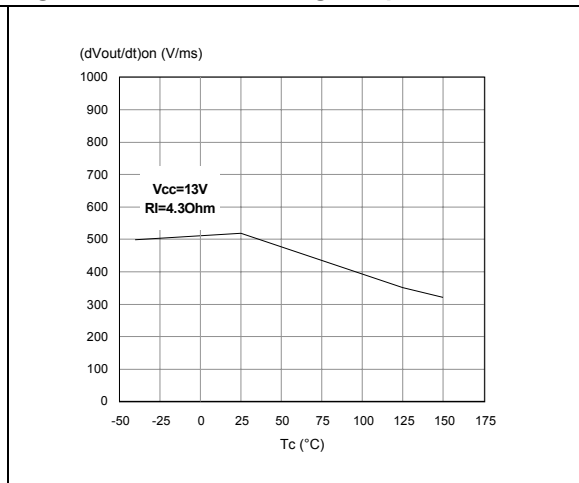


Figure 16. I_{LIMH} vs T_{case}

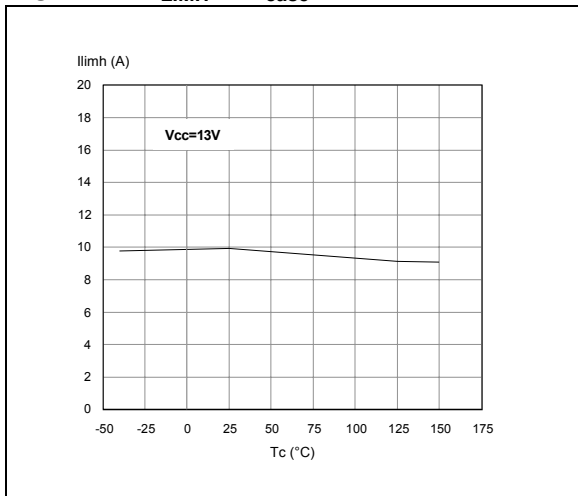
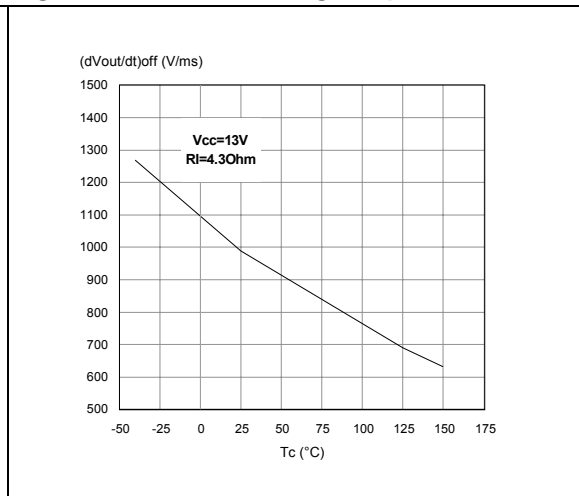


Figure 17. Turn-off voltage slope



3.3 Electrical characteristics for low-side switches

Values specified in this section are for $-40\text{ °C} < T_j < 150\text{ °C}$, unless otherwise specified

Table 11. Off

Symbol	Parameter	Test conditions	Min	Typ	Max	Unit
V_{CLAMP}	Drain-source clamp voltage	$V_{IN} = 0\text{ V}; I_D = 1.5\text{ A}$	40	45	55	V
V_{CLTH}	Drain-source clamp threshold voltage	$V_{IN} = 0\text{ V}; I_D = 2\text{ mA}$	36			V
V_{INTH}	Input threshold voltage	$V_{DS} = V_{IN}; I_D = 1\text{ mA}$	0.5		2.5	V
I_{ISS}	Supply current from input pin	$V_{DS} = 0\text{ V}; V_{IN} = 5\text{ V}$		100	150	μA
V_{INCL}	Input-source clamp voltage	$I_{IN} = 1\text{ mA}$	6	6.8	8	V
		$I_{IN} = -1\text{ mA}$	-1.0		-0.3	V
I_{DSS}	Zero input voltage drain current ($V_{IN} = 0\text{ V}$)	$V_{DS} = 13\text{ V}; V_{IN} = 0\text{ V}; T_j = 25\text{ °C}$			30	μA
		$V_{DS} = 25\text{ V}; V_{IN} = 0\text{ V}$			75	μA

Table 12. On

Symbol	Parameter	Test conditions	Min	Typ	Max	Unit
$R_{DS(on)}$	Static drain-source on resistance	$V_{IN} = 5\text{ V}; I_D = 3\text{ A}; T_j = 25\text{ °C}$	—	—	120	m Ω
		$V_{IN} = 5\text{ V}; I_D = 3\text{ A}$	—	—	240	m Ω

Table 13. Dynamic ($T_j = 25\text{ °C}$, unless otherwise specified)

Symbol	Parameter	Test conditions	Min	Typ	Max	Unit
g_{fs}	Forward transconductance	$V_{DD} = 13\text{ V}; I_D = 1.5\text{ A}$	—	2.5	—	S
C_{OSS}	Output capacitance	$V_{DS} = 13\text{ V}; f = 1\text{ MHz}; V_{IN} = 0\text{ V}$	—	150	—	pF

Table 14. Switching ($T_j = 25\text{ °C}$, unless otherwise specified)

Symbol	Parameter	Test conditions	Min	Typ	Max	Unit
$t_{d(on)}$	Turn-on delay time	$V_{DD} = 15\text{ V}; I_D = 3\text{ A}; V_{gen} = 5\text{ V}; R_{gen} = R_{IN\text{ MIN}} = 220\ \Omega$	—	200	400	ns
t_r	Rise time		—	1.2	2.5	μs
$t_{d(off)}$	Turn-off delay time		—	600	1350	ns
t_f	Fall time		—	400	1000	ns

Table 14. Switching ($T_j = 25\text{ °C}$, unless otherwise specified)

Symbol	Parameter	Test conditions	Min	Typ	Max	Unit
$t_{d(on)}$	Turn-on delay time	$V_{DD} = 15\text{ V}; I_D = 3\text{ A}$ $V_{gen} = 5\text{ V}; R_{gen} = 2.2\text{ K}\Omega$	—	0.80	2.5	μs
t_r	Rise time		—	3.7	7.5	μs
$t_{d(off)}$	Turn-off delay time		—	2.6	7.5	μs
t_f	Fall time		—	2.3	7.0	μs
$(dl/dt)_{on}$	Turn-on current slope	$V_{DD} = 15\text{ V}; I_D = 3\text{ A}; V_{gen} = 5\text{ V};$ $R_{gen} = R_{IN\text{ MINn}} = 220\ \Omega$	—	3.0		$\text{A}/\mu\text{s}$
Q_i	Total input charge	$V_{DD} = 12\text{ V}; I_D = 3\text{ A}; V_{IN} = 5\text{ V};$ $I_{gen} = 2.13\text{ mA}$	—	9.0		nC

Table 15. Source drain diode

Symbol	Parameter	Test conditions	Min	Typ	Max	Unit
$V_{SD}^{(1)}$	Forward on voltage	$I_{SD} = 1.5\text{ A}; V_{IN} = 0\text{ V}$	—	0.8	—	V
t_{rr}	Reverse recovery time	$I_{SD} = 1.5\text{ A}; dl/dt = 12\text{ A/ms}$ $V_{DD} = 30\text{ V}; L = 200\ \mu\text{H}$	—	400	—	ns
Q_{rr}	Reverse recovery charge		—	200	—	nC
I_{RRM}	Reverse recovery current		—	1.0	—	A

1. Pulsed: Pulse duration = 300 μs , duty cycle 1.5%

Table 16. Protection and diagnostics ($-40\text{ °C} < T_j < 150\text{ °C}$, unless otherwise specified)

Symbol	Parameter	Test conditions	Min	Typ	Max	Unit
I_{lim}	Drain current limit	$V_{IN} = 5\text{ V}; V_{DS} = 13\text{ V}$	6	8.5	12	A
t_{dlim}	Step response current limit	$V_{IN} = 5\text{ V}; V_{DS} = 13\text{ V}$		10		μs
T_{jsh}	Overtemperature shutdown		150	175	200	$^{\circ}\text{C}$
T_{jrs}	Overtemperature reset		135			$^{\circ}\text{C}$
I_{gf}	Fault sink current	$V_{IN} = 5\text{ V}; V_{DS} = 13\text{ V}; T_j = T_{jsh}$	10	15	20	mA
E_{as}	Single pulse avalanche energy	Starting $T_j = 25\text{ °C}; V_{DD} = 24\text{ V};$ $V_{IN} = 5\text{ V}; R_{gen} = R_{IN\text{ MINn}} = 220\ \Omega;$ $L = 24\text{ mH}$	100			mJ

3.4 Electrical characteristics curves for low-side switches

Figure 18. Static drain source on resistance

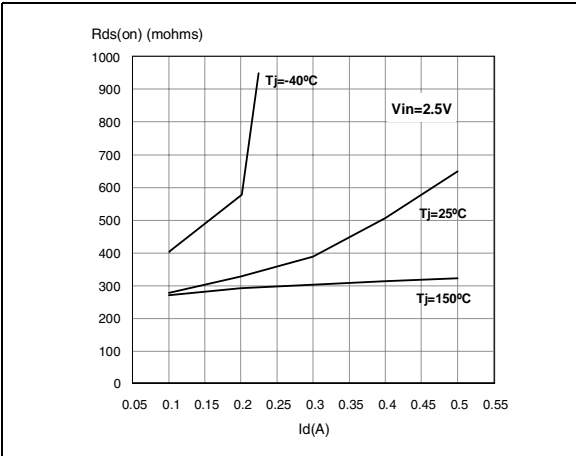


Figure 19. Derating curve

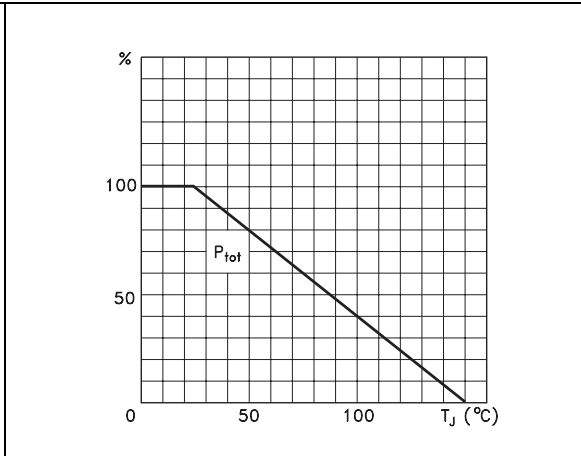


Figure 20. Transconductance

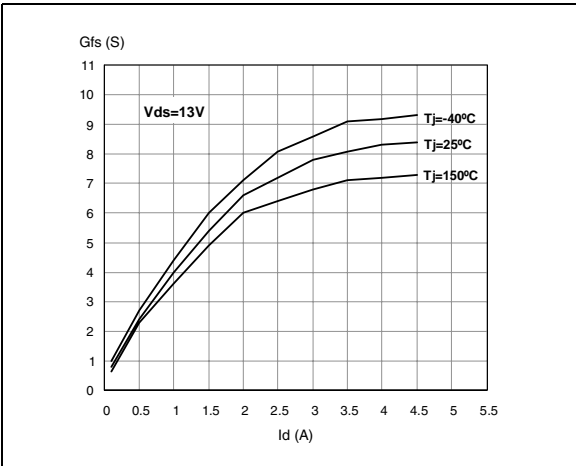


Figure 21. Transfer characteristics

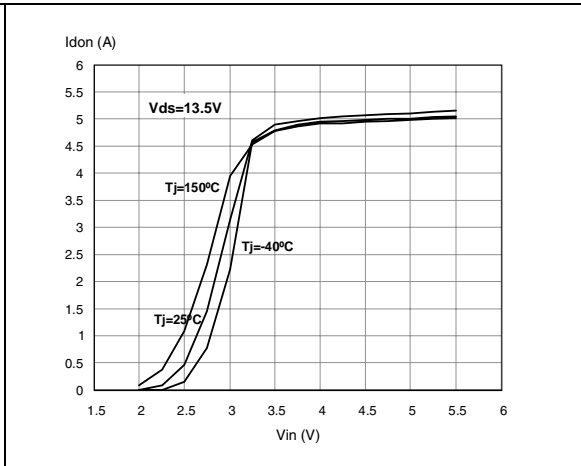


Figure 22. Input voltage vs input charge

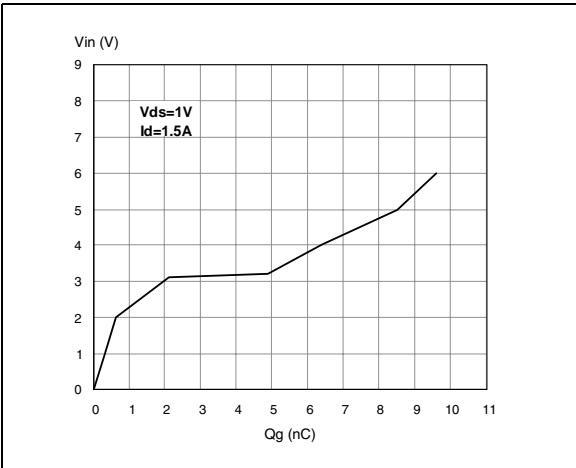


Figure 23. Capacitance variations

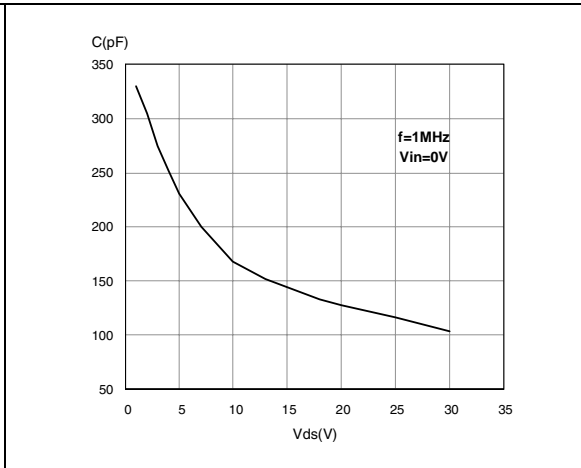


Figure 24. Output characteristics

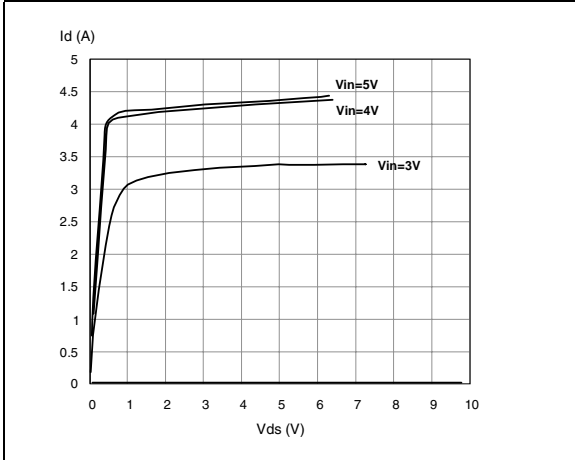


Figure 25. Step response current limit

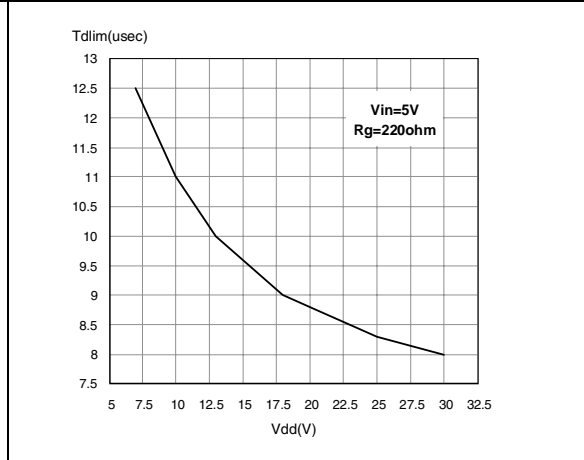


Figure 26. Source-drain diode forward characteristics

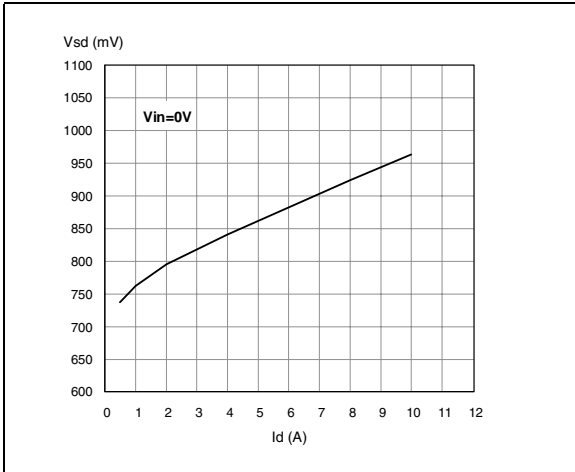


Figure 27. Static drain-source on resistance vs I_D

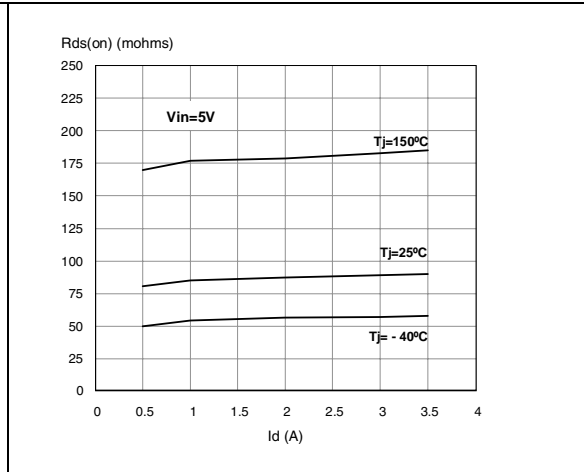


Figure 28. Static drain-source on resistance vs input voltage (part 1)

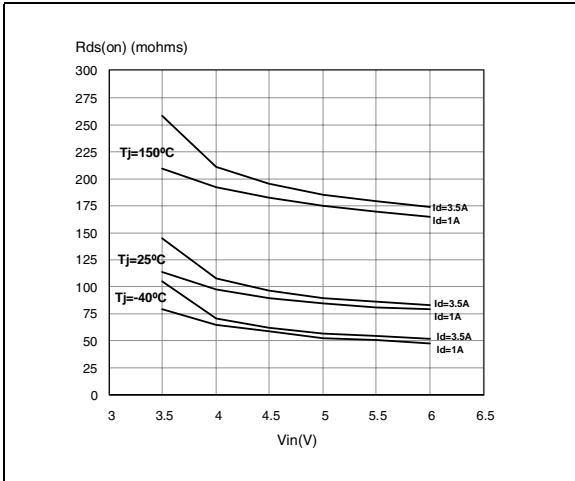


Figure 29. Static drain-source on resistance vs input voltage (part 2)

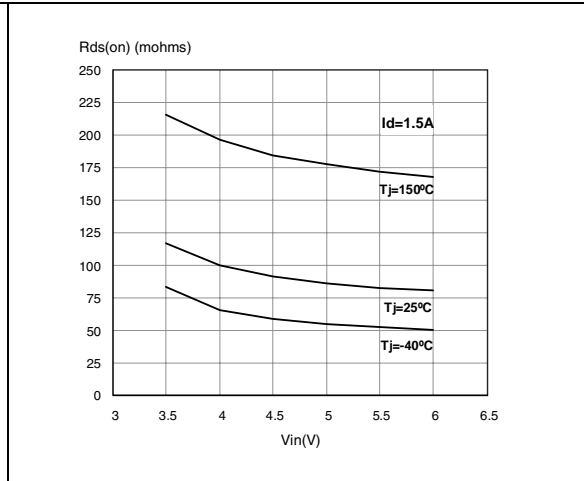


Figure 30. Normalized input threshold voltage vs temperature Figure 31. Normalized on resistance vs temperature

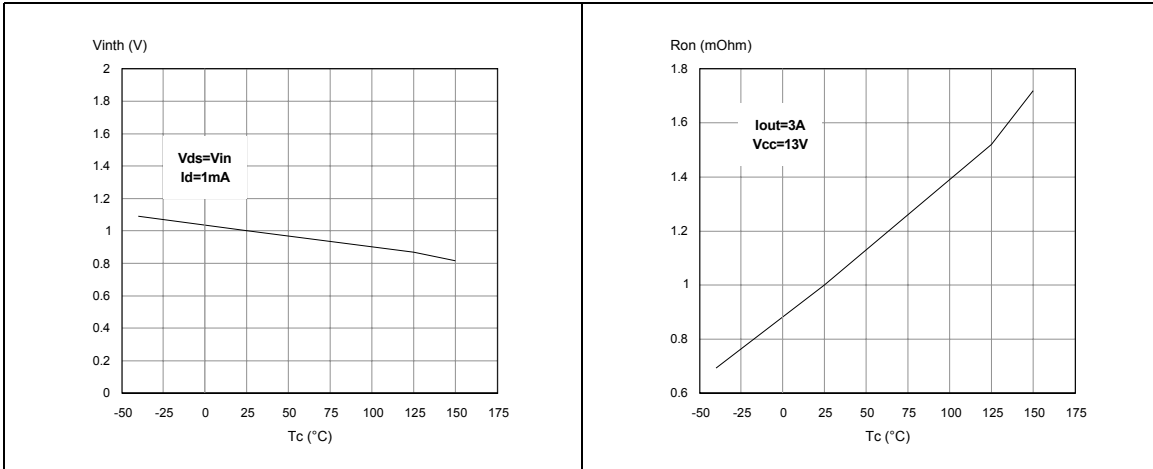
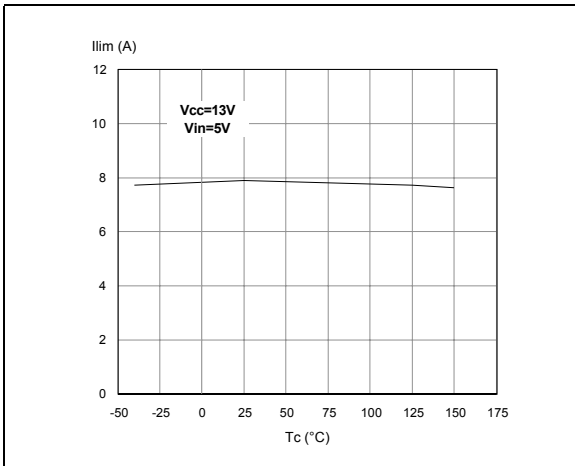
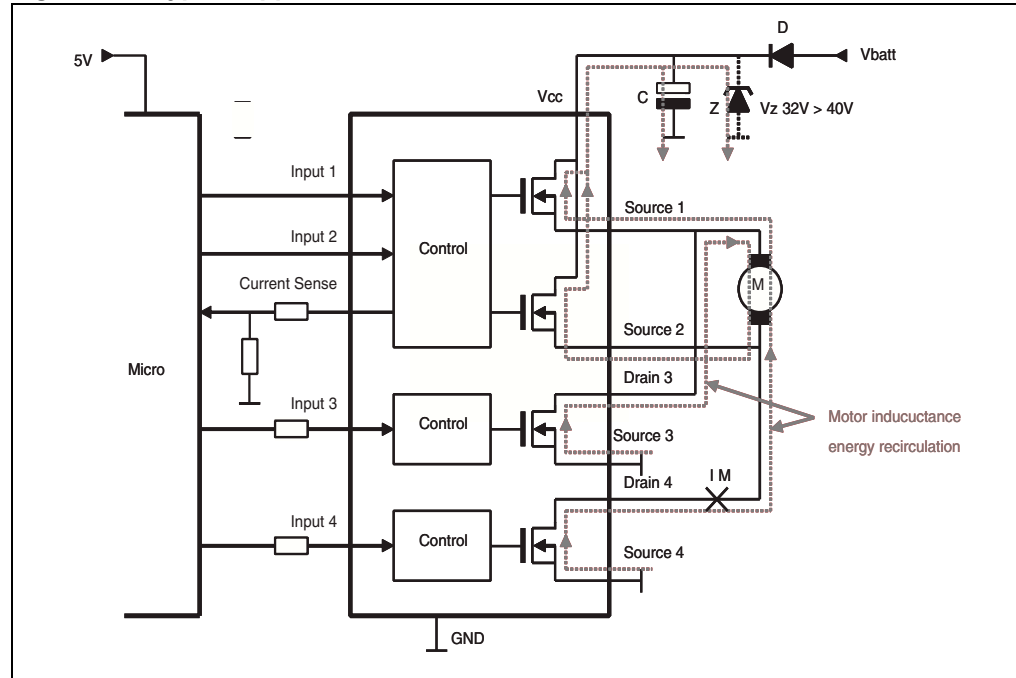


Figure 32. Current limit vs junction temperature



4 Application information

Figure 33. Typical application schematic



Note: *Mostly motor bridge drivers use a reverse battery protection diode (D) inside supply rail. This diode prevents a reverse current flow back to Vbatt in case the bridge gets disabled via the logic inputs while motor inductance still carries energy. In order to prevent a hazardous overvoltage at circuit supply terminal (Vcc), a blocking capacitor (C) is needed to limit the voltage overshoot. As basic orientation, 50µF per 1A load current is recommended. In alternative, also a Zener protection (Z) is suitable. Even if a reverse polarity diode is not present, it is recommended to use a capacitor or zener at Vcc because a similar problem appears in case supply terminal of the module has intermittent electrical contact to the battery or gets disconnected while motor is operating.*

Figure 34. Recommended motor operation

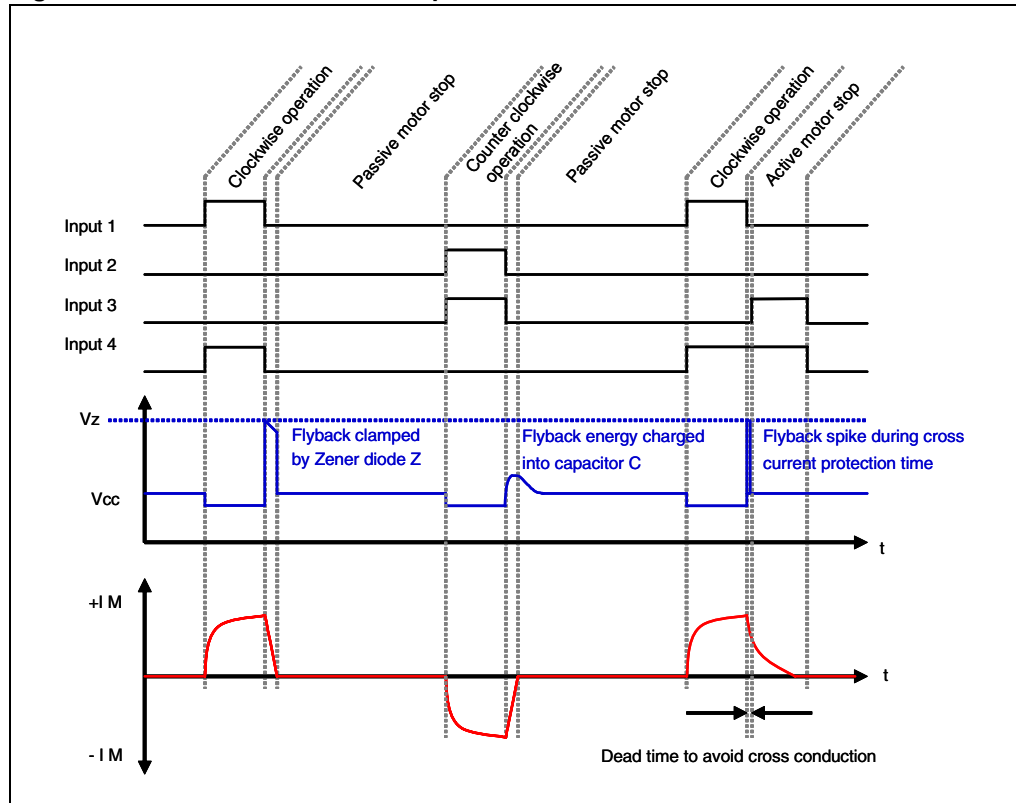
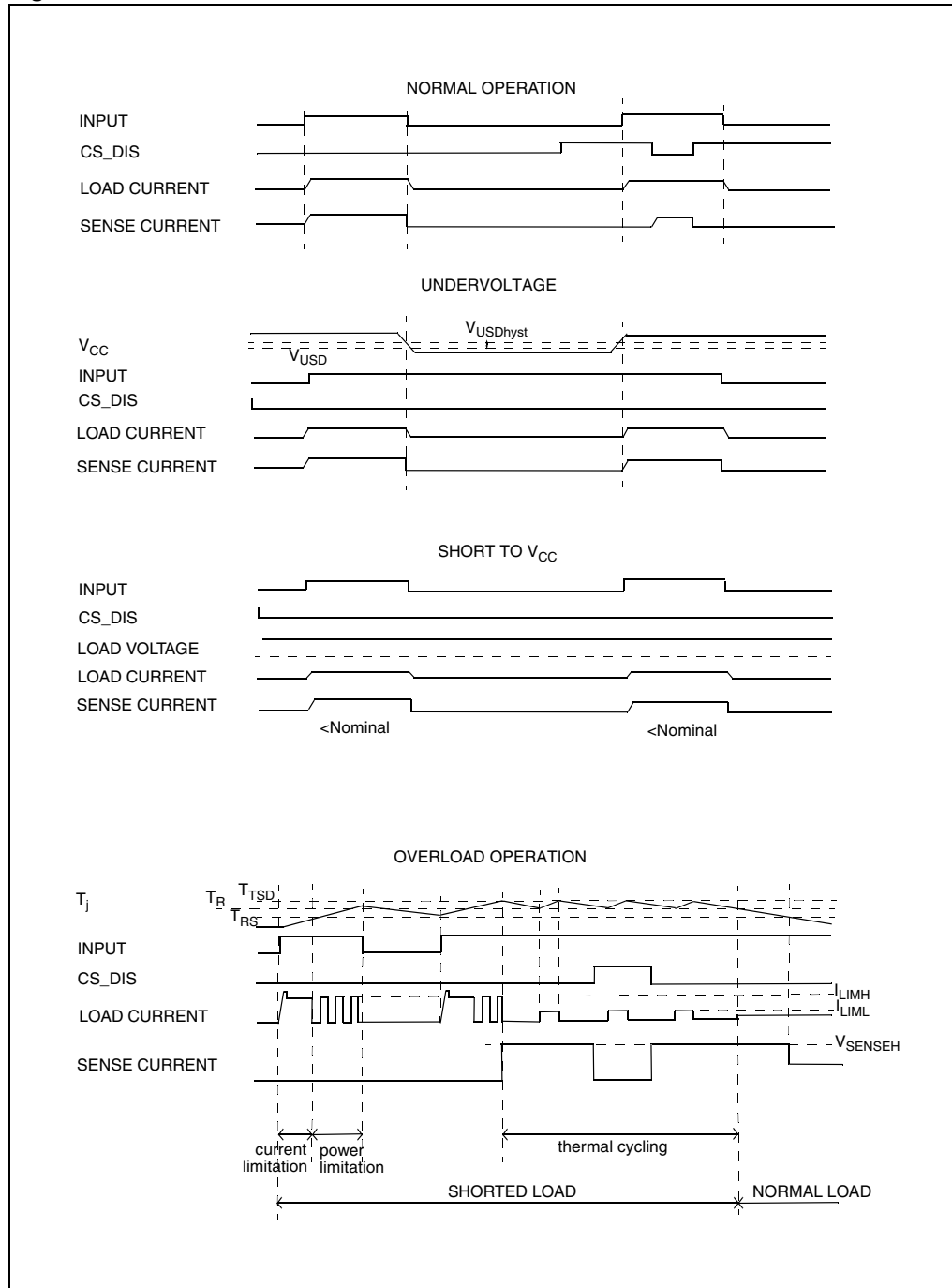
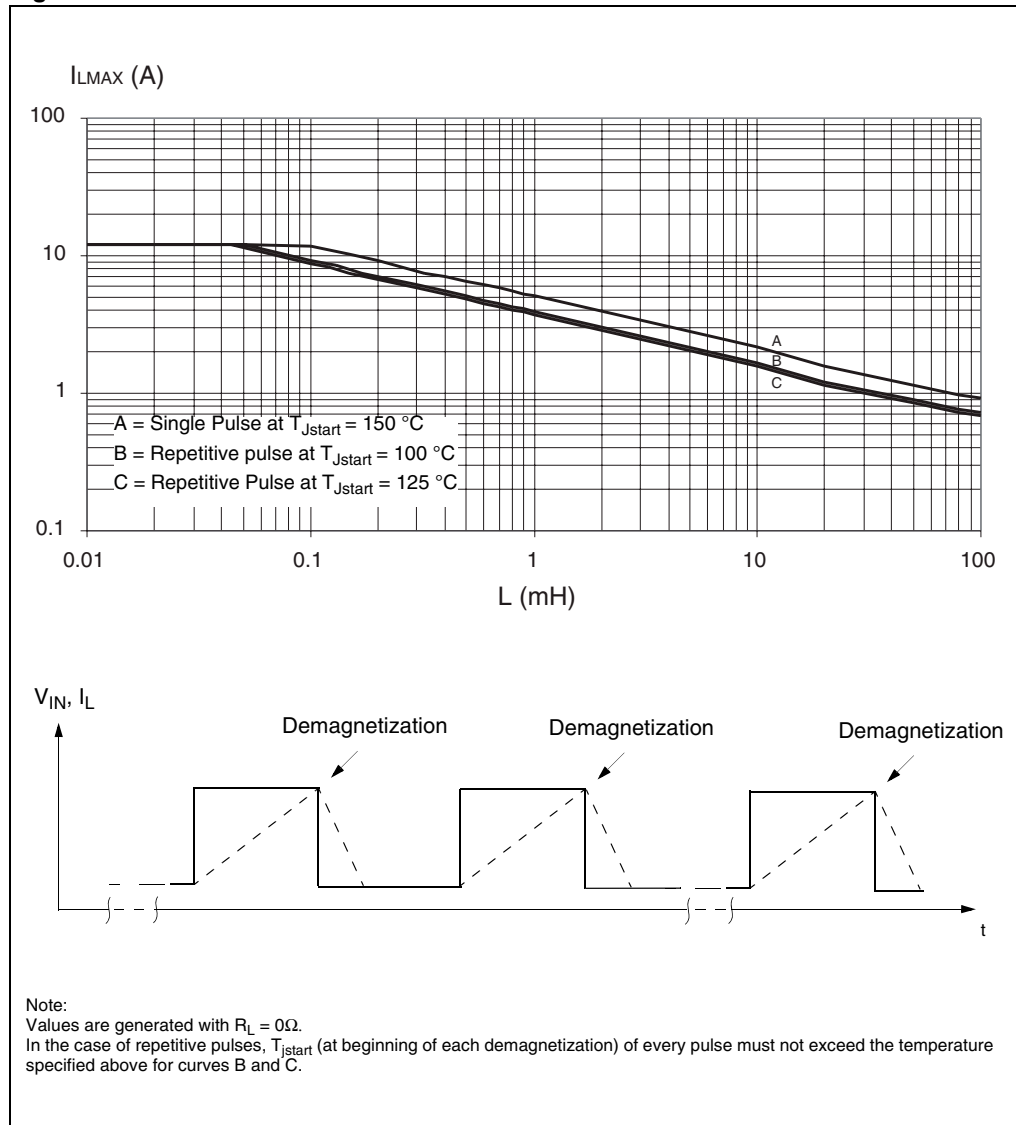


Figure 35. Waveforms



4.1 Maximum demagnetization energy ($V_{CC} = 13.5\text{ V}$)

Figure 36. Maximum turn off current versus load inductance



5 Package and thermal data

5.1 SO-28 thermal data

Figure 37. SO-28 PC board

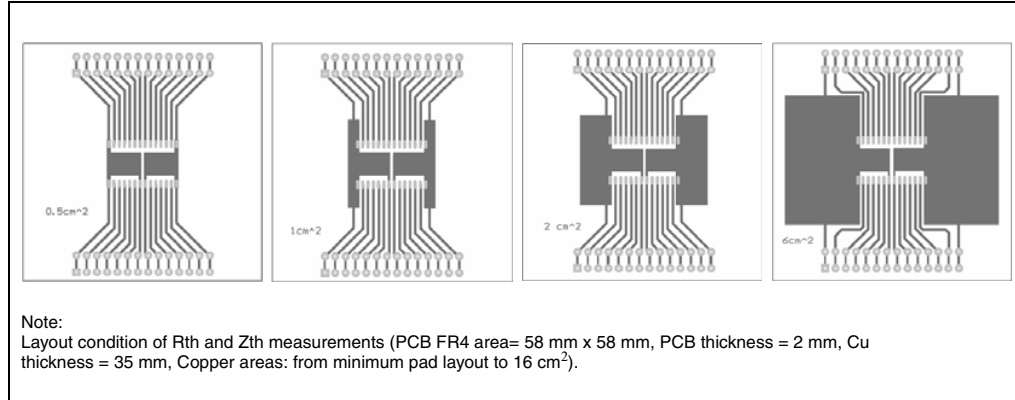


Figure 38. Chipset configuration

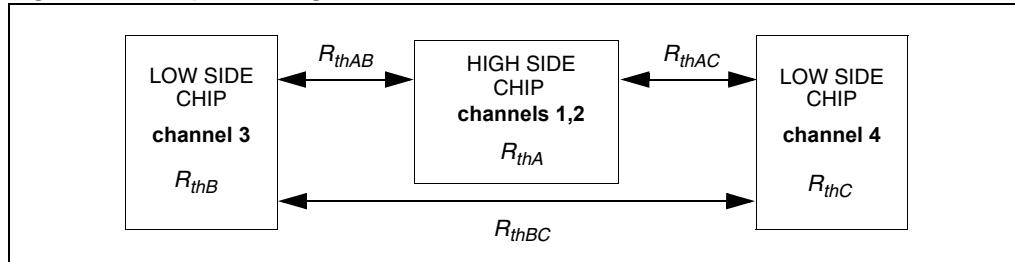


Figure 39. Auto and mutual Rthj-amb vs PCB copper area in open box free air condition

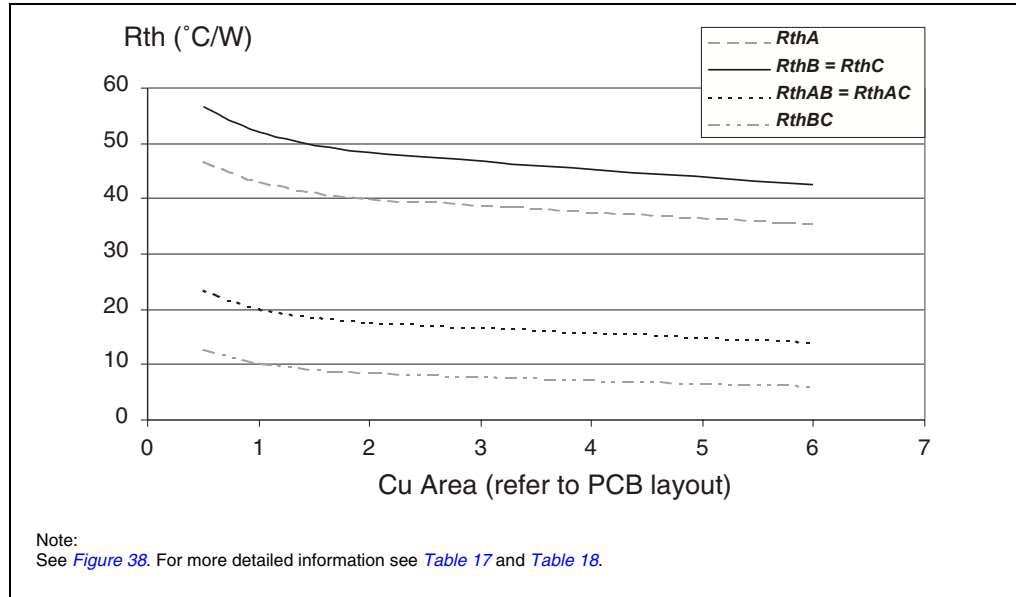


Table 17. Thermal calculations in clockwise and anti-clockwise operation in steady-state mode

HS ₁	HS ₂	LS ₃	LS ₄	T _{JHS12}	T _{JLS3}	T _{JLS4}
ON	OFF	OFF	ON	$P_{dHS1} \times R_{thHS} + P_{dLS4} \times R_{thHLSL} + T_{amb}$	$P_{dHS1} \times R_{thHLSL} + P_{dLS4} \times R_{thLSL} + T_{amb}$	$P_{dHS1} \times R_{thHLSL} + P_{dLS4} \times R_{thLS} + T_{amb}$
OFF	ON	ON	OFF	$P_{dHS2} \times R_{thHS} + P_{dLS3} \times R_{thHLSL} + T_{amb}$	$P_{dHS2} \times R_{thHLSL} + P_{dLS3} \times R_{thLS} + T_{amb}$	$P_{dHS2} \times R_{thHLSL} + P_{dLS3} \times R_{thLSL} + T_{amb}$

Table 18. Thermal resistances definitions⁽¹⁾

$R_{thHS} = R_{thHS1} = R_{thHS2}$	High-side chip thermal resistance junction to ambient (HS ₁ or HS ₂ in ON-state)
$R_{thLS} = R_{thLS3} = R_{thLS4}$	Low-side chip thermal resistance junction to ambient
$R_{thHLSL} = R_{thHS1LS4} = R_{thHS2LS3}$	Mutual thermal resistance junction to ambient between high-side and low-side chips
$R_{thLSL} = R_{thLS3LS4}$	Mutual thermal resistance junction to ambient between low-side chips

1. values dependent on PCB heatsink area

Table 19. Single pulse thermal impedance definitions⁽¹⁾

Z_{thHS}	High-side chip thermal impedance junction to ambient
$Z_{thLS} = Z_{thLS3} = Z_{thLS4}$	Low-side chip thermal impedance junction to ambient

Table 19. Single pulse thermal impedance definitions⁽¹⁾

$Z_{thHLSLS} = Z_{thHS12LS3} = Z_{thHS12LS4}$	Mutual thermal impedance junction to ambient between high-side and low-side chips
$Z_{thLSLS} = Z_{thLS3LS4}$	Mutual thermal impedance junction to ambient between low-side chips

1. values dependent on PCB heatsink area

Table 20. Thermal calculations in transient mode⁽¹⁾

T_{jHS12}	$Z_{thHS} \times P_{dHS12} + Z_{thHLSLS} \times (P_{dLS3} + P_{dLS4}) + T_{amb}$
T_{jLS3}	$Z_{thHLSLS} \times P_{dHS12} + Z_{thLS} \times P_{dLS3} + Z_{thLSLS} \times P_{dLS4} + T_{amb}$
T_{jLS4}	$Z_{thHLSLS} \times P_{dHS12} + Z_{thLSLS} \times P_{dLS3} + Z_{thLS} \times P_{dLS4} + T_{amb}$

1. Calculation is valid in any dynamic operating condition. Pd values set by user.

Figure 40. SO-28 HSD thermal impedance junction ambient single pulse

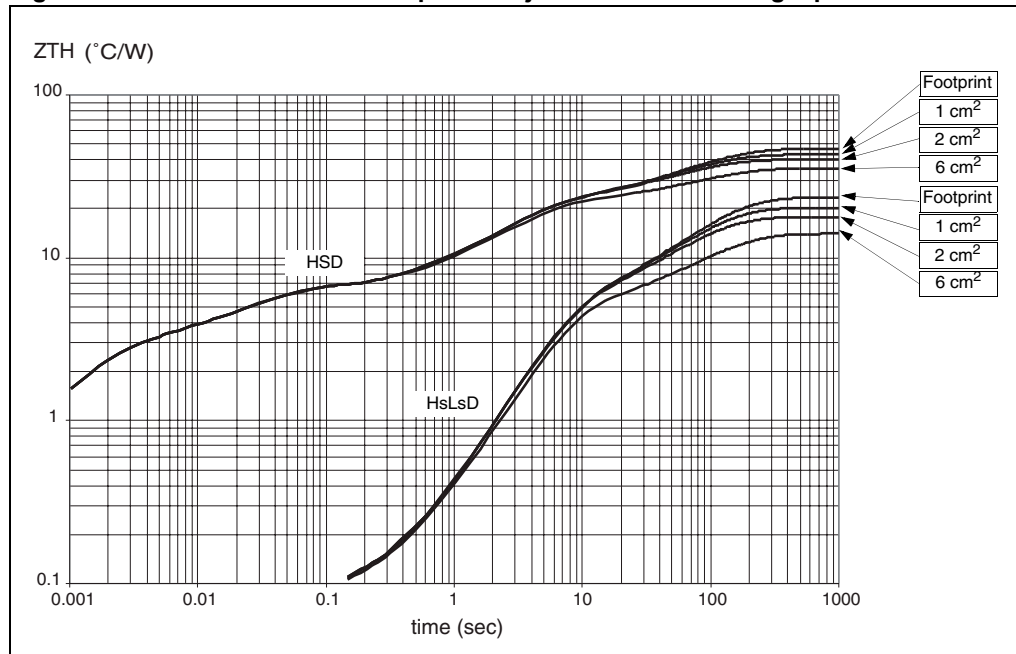
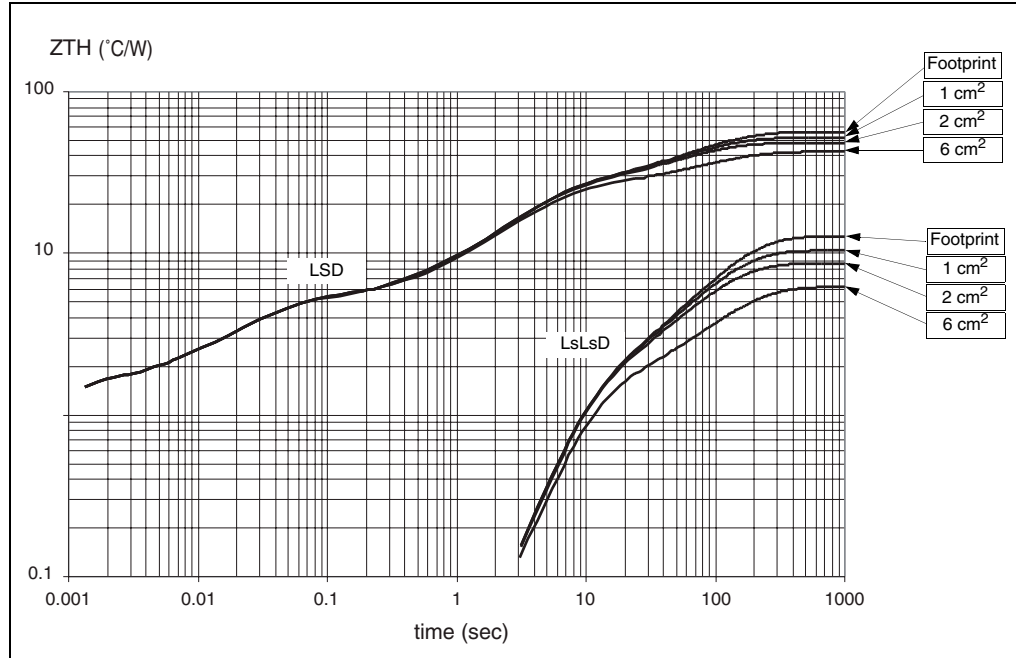


Figure 41. SO-28 LSD thermal impedance junction ambient single pulse



Equation 1: pulse calculation formula

$$Z_{TH\delta} = R_{TH} \cdot \delta + Z_{THtp}(1 - \delta)$$

where $\delta = t_p/T$

Figure 42. Thermal fitting model of an H-bridge in SO-28

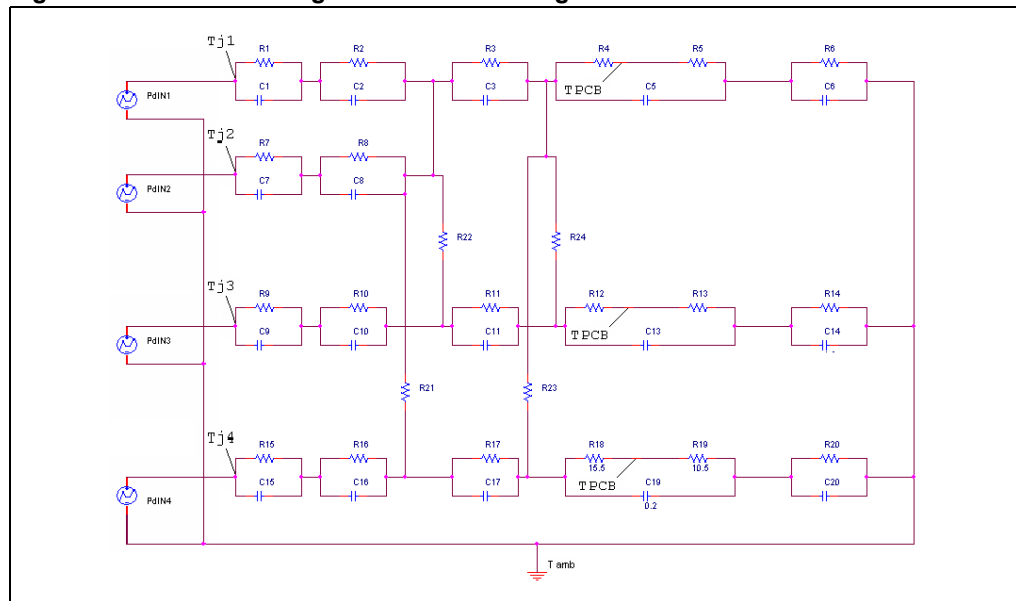


Table 21. Thermal parameters⁽¹⁾

Area/island (cm ²)	Footprint	1	2	6
R1 = R7 (°C/W)	1			
R2 = R8 (°C/W)	1.8			
R3 = R11 = R17 (°C/W)	3.5			
R4 (°C/W)	13.5			
R5 = R13 = R19 (°C/W)	10.5			
R6 = R14 = R20 (°C/W)	62.28	52.28	44.28	32.28
R9 = R15 (°C/W)	0.24			
R10 = R16 (°C/W)	1.2			
R12 (°C/W)	15.2			
R18 (°C/W)	15.5			
R21 = R22 = R23 (°C/W)	150			
R24 (°C/W)	150	52.28	44.28	32.28
C1 = C7 (W·s/°C)	0.0008			
C2 = C8 (W·s/°C)	0.001			
C3 = C11 = C17 (W·s/°C)	0.008			
C5 = C13 = C19 (W·s/°C)	0.2			
C6 = C14 = C20 (W·s/°C)	1.6	1.61	1.7	3.25
C9 = C15 (W·s/°C)	0.00015			
C10 = C16 (W·s/°C)	0.0005			

1. A blank space means that the value is the same as the previous one.

6 Package and packing information

6.1 ECOPACK[®] packages

In order to meet environmental requirements, ST offers these devices in different grades of ECOPACK[®] packages, depending on their level of environmental compliance. ECOPACK[®] specifications, grade definitions and product status are available at: www.st.com.

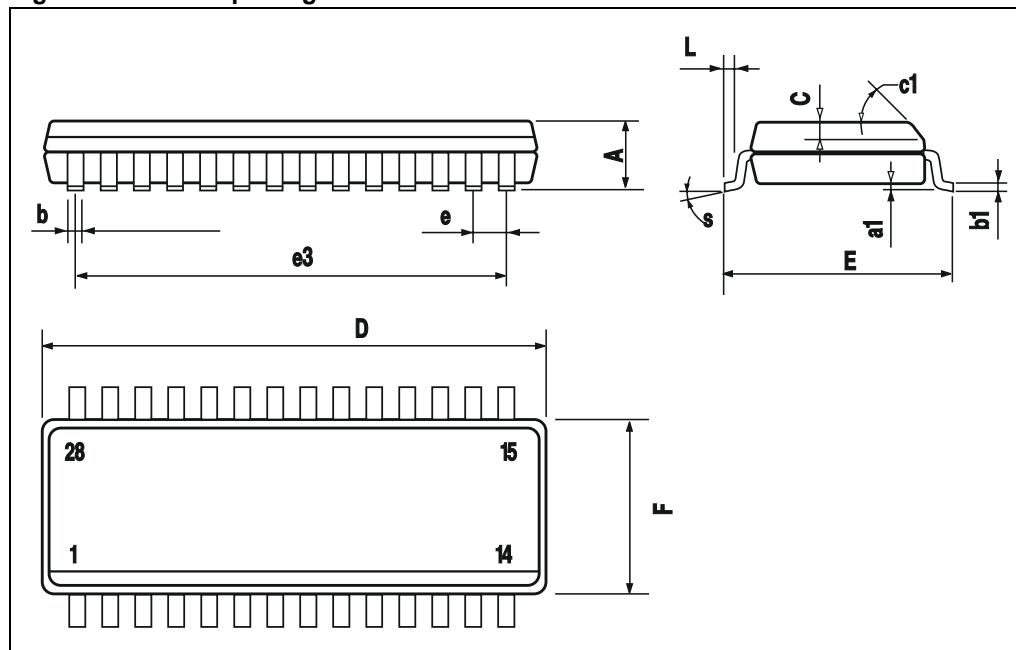
ECOPACK[®] is an ST trademark.

6.2 SO-28 package information

Table 22. SO-28 mechanical data

Symbol	Millimeters		
	Min	Typ	Max
A			2.65
a1	0.10		0.30
b	0.35		0.49
b1	0.23		0.32
C		0.50	
c1	45° (typ.)		
D	17.7		18.1
E	10.00		10.65
e		1.27	
e3		16.51	
F	7.40		7.60
L	0.40		1.27
S	8° (max.)		

Figure 43. SO-28 package dimensions



6.3 SO-28 packing information

Figure 44. SO-28 tube shipment (no suffix)

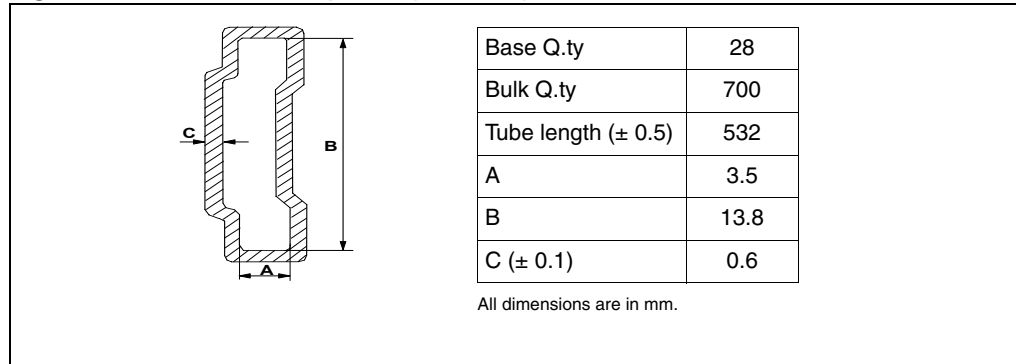
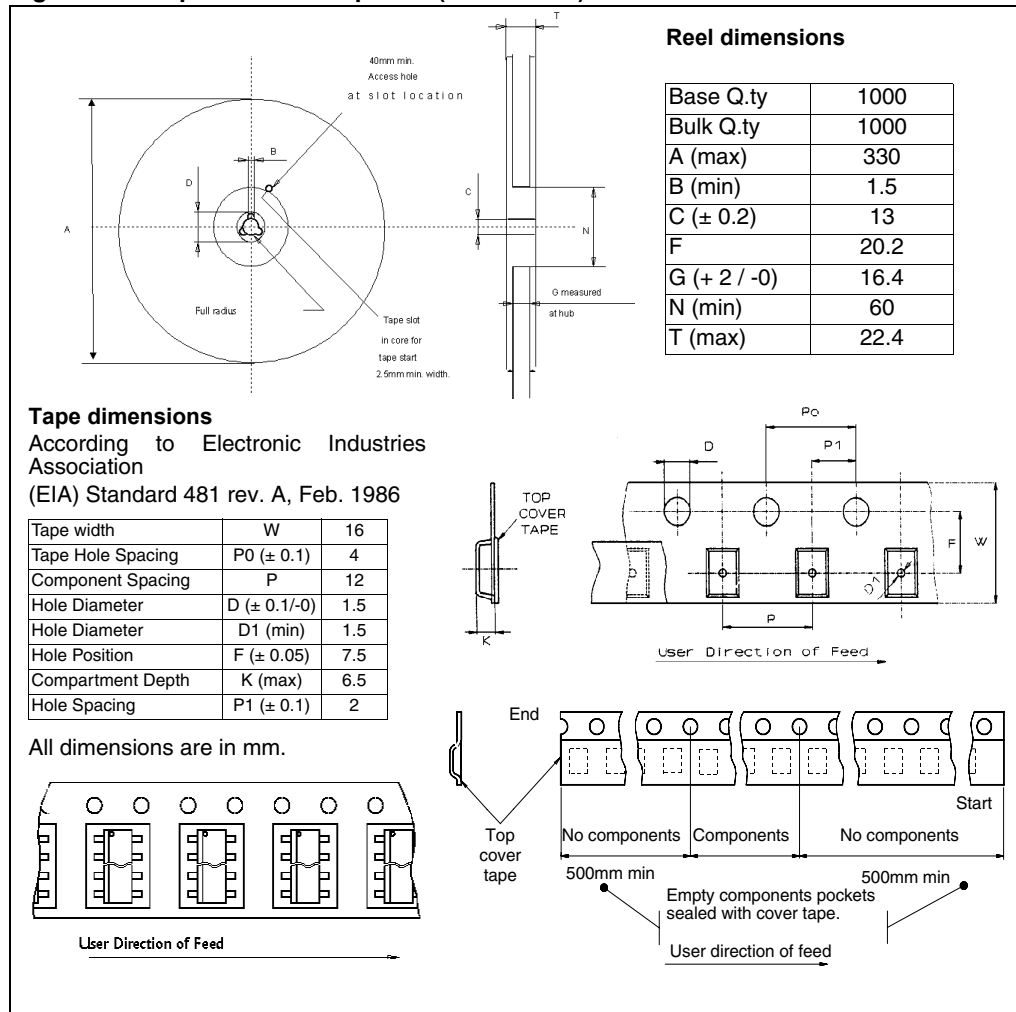


Figure 45. Tape and reel shipment (suffix "TR")



7 Order codes

Table 23. Device summary

Package	Order codes	
	Tube	Tape and reel
SO-28	VN5770AKP-E	VN5770AKPTR-E

8 Revision history

Table 24. Document revision history

Date	Revision	Changes
11-Nov-2010	1	Initial release.

Please Read Carefully:

Information in this document is provided solely in connection with ST products. STMicroelectronics NV and its subsidiaries ("ST") reserve the right to make changes, corrections, modifications or improvements, to this document, and the products and services described herein at any time, without notice.

All ST products are sold pursuant to ST's terms and conditions of sale.

Purchasers are solely responsible for the choice, selection and use of the ST products and services described herein, and ST assumes no liability whatsoever relating to the choice, selection or use of the ST products and services described herein.

No license, express or implied, by estoppel or otherwise, to any intellectual property rights is granted under this document. If any part of this document refers to any third party products or services it shall not be deemed a license grant by ST for the use of such third party products or services, or any intellectual property contained therein or considered as a warranty covering the use in any manner whatsoever of such third party products or services or any intellectual property contained therein.

UNLESS OTHERWISE SET FORTH IN ST'S TERMS AND CONDITIONS OF SALE ST DISCLAIMS ANY EXPRESS OR IMPLIED WARRANTY WITH RESPECT TO THE USE AND/OR SALE OF ST PRODUCTS INCLUDING WITHOUT LIMITATION IMPLIED WARRANTIES OF MERCHANTABILITY, FITNESS FOR A PARTICULAR PURPOSE (AND THEIR EQUIVALENTS UNDER THE LAWS OF ANY JURISDICTION), OR INFRINGEMENT OF ANY PATENT, COPYRIGHT OR OTHER INTELLECTUAL PROPERTY RIGHT.

UNLESS EXPRESSLY APPROVED IN WRITING BY AN AUTHORIZED ST REPRESENTATIVE, ST PRODUCTS ARE NOT RECOMMENDED, AUTHORIZED OR WARRANTED FOR USE IN MILITARY, AIR CRAFT, SPACE, LIFE SAVING, OR LIFE SUSTAINING APPLICATIONS, NOR IN PRODUCTS OR SYSTEMS WHERE FAILURE OR MALFUNCTION MAY RESULT IN PERSONAL INJURY, DEATH, OR SEVERE PROPERTY OR ENVIRONMENTAL DAMAGE. ST PRODUCTS WHICH ARE NOT SPECIFIED AS "AUTOMOTIVE GRADE" MAY ONLY BE USED IN AUTOMOTIVE APPLICATIONS AT USER'S OWN RISK.

Resale of ST products with provisions different from the statements and/or technical features set forth in this document shall immediately void any warranty granted by ST for the ST product or service described herein and shall not create or extend in any manner whatsoever, any liability of ST.

ST and the ST logo are trademarks or registered trademarks of ST in various countries.

Information in this document supersedes and replaces all information previously supplied.

The ST logo is a registered trademark of STMicroelectronics. All other names are the property of their respective owners.

© 2010 STMicroelectronics - All rights reserved

STMicroelectronics group of companies

Australia - Belgium - Brazil - Canada - China - Czech Republic - Finland - France - Germany - Hong Kong - India - Israel - Italy - Japan - Malaysia - Malta - Morocco - Philippines - Singapore - Spain - Sweden - Switzerland - United Kingdom - United States of America

www.st.com