

General Description

The MIC921 is a high-speed operational amplifier with a gain-bandwidth product of 45MHz. The part is unity gain stable. It has a very low 300µA supply current, and features the IttyBitty™ SC-70 and SOT-23-5 package.

Supply voltage range is from ±2.5V to ±9V, allowing the MIC921 to be used in low-voltage circuits or applications requiring large dynamic range.

The MIC921 is stable driving any capacitive load and achieves excellent PSRR and CMRR, making it much easier to use than most conventional high-speed devices. Low supply voltage, low power consumption, and small packing make the MIC921 ideal for portable equipment. The ability to drive capacitive loads also makes it possible to drive long coaxial cables.

Features

- 45MHz gain bandwidth product
- 61MHz –3dB bandwidth
- 300µA supply current
- SC-70 or SOT-23-5 packages
- 3200V/µs slew rate
- Drives any capacitive load
- 112dB CMRR
- Unity gain stable

Applications

- Video
- Imaging
- Ultrasound
- Portable equipment
- Line drivers

Ordering Information

| Part Number | | | | Ambient Temperature | Package |
|-------------|---------|-----------|---------|---------------------|-----------|
| Standard | Marking | Pb-Free | Marking | | |
| MIC921BM5 | A38 | | | –40°C to +85°C | SOT-23-5* |
| MIC921BC5 | A38 | MIC921YC5 | A38 | –40°C to +85°C | SC-70-5 |

* Contact factory for availability of SOT-23-5 package.
Note: Underbar marking may not be to scale.

Pin Configuration

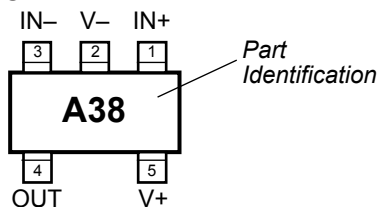

SOT-23-5 or SC-70

Functional Pinout

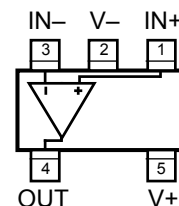

SOT-23-5 or SC-70

Pin Description

| Pin Number | Pin Name | Pin Function |
|------------|----------|--------------------------|
| 1 | IN+ | Noninverting Input |
| 2 | V– | Negative Supply (Input) |
| 3 | IN– | Inverting Input |
| 4 | OUT | Output: Amplifier Output |
| 5 | V+ | Positive Supply (Input) |

IttyBitty is a trademark of Micrel, Inc.

Micrel, Inc. • 2180 Fortune Drive • San Jose, CA 95131 • USA • tel + 1 (408) 944-0800 • fax + 1 (408) 474-1000 • <http://www.micrel.com>

Absolute Maximum Ratings (Note 1)

| | |
|-----------------------------------------------------------|----------------------|
| Supply Voltage ($V_{V+} - V_{V-}$)..... | 20V |
| Differential Input Voltage ($ V_{IN+} - V_{IN-} $)..... | 4V, Note 3 |
| Input Common-Mode Range (V_{IN+}, V_{IN-})..... | V_{V+} to V_{V-} |
| Lead Temperature (soldering, 5 sec.)..... | 260°C |
| Storage Temperature (T_S)..... | 150°C |
| ESD Rating, Note 4 | 1.5kV |

Operating Ratings (Note 2)

| | |
|-------------------------------------|--------------------------------|
| Supply Voltage (V_S)..... | $\pm 2.5V$ to $\pm 9V$ |
| Junction Temperature (T_J)..... | $-40^\circ C$ to $+85^\circ C$ |
| Package Thermal Resistance | |
| SC70-5 | 450°C/W |
| SOT23-5 | 260°C/W |

Electrical Characteristics ($\pm 5V$)

$V_+ = +5V$, $V_- = -5V$, $V_{CM} = 0V$, $R_L = 10M\Omega$; $T_J = 25^\circ C$, **bold** values indicate $-40^\circ C \leq T_J \leq +85^\circ C$; unless noted.

| Symbol | Parameter | Condition | Min | Typ | Max | Units |
|-----------|----------------------------------|-----------------------------------------------------------------------------------|--------------|------|--------------|------------------|
| V_{OS} | Input Offset Voltage | | | 0.43 | 5 | mV |
| V_{OS} | V_{OS} Temperature Coefficient | | | 1 | | $\mu V/^\circ C$ |
| I_B | Input Bias Current | | | 0.13 | 0.6 | μA |
| I_{OS} | Input Offset Current | | | 0.06 | 0.3 | μA |
| V_{CM} | Input Common-Mode Range | CMRR > 72dB | -3.25 | | +3.25 | V |
| CMRR | Common-Mode Rejection Ratio | $-2.5V < V_{CM} < +2.5V$ | 75 | 87 | | dB |
| PSRR | Power Supply Rejection Ratio | $\pm 3.5V < V_S < \pm 9V$ | 95 | 105 | | dB |
| A_{VOL} | Large-Signal Voltage Gain | $R_L = 2k, V_{OUT} = \pm 2V$ | 70 | 84 | | dB |
| | | $R_L = 100\Omega, V_{OUT} = \pm 1V$ | | 85 | | dB |
| V_{OUT} | Maximum Output Voltage Swing | positive, $R_L = 2k\Omega$ | +3.0 | 3.7 | | V |
| | | negative, $R_L = 2k\Omega$ | | -3.7 | -3.0 | V |
| | | positive, $R_L = 200\Omega$ | +1.5 | 3.0 | | V |
| | | negative, $R_L = 200\Omega$, Note 5 | | -2.5 | -1.0 | V |
| GBW | Unity Gain-Bandwidth Product | $A_V = 1, C_L = 1.7pF$ | | 37 | | MHz |
| PM | Phase Margin | | | 46 | | ° |
| BW | -3dB Bandwidth | $A_V = 1, R_L = 1k\Omega, C_L = 1.7pF$ | | 53 | | MHz |
| SR | Slew Rate | $C = 1.7pF$, Gain=1, $V_{OUT} = 5V$, peak to peak, negative SR = 1300V/ μs | | 1500 | | V/ μs |
| I_{SC} | Short-Circuit Output Current | source | 45 | 57 | | mA |
| | | sink | 20 | 40 | | mA |
| I_S | Supply Current | No Load | | 0.30 | 0.50 | mA |
| | Input Voltage Noise | $f = 10kHz$ | | 12 | | $nV\sqrt{Hz}$ |
| | Input Current Noise | $f = 10kHz$ | | 0.7 | | $pA\sqrt{Hz}$ |

Electrical Characteristics

$V_+ = +9V$, $V_- = -9V$, $V_{CM} = 0V$, $R_L = 10M\Omega$; $T_J = 25^\circ C$, **bold** values indicate $-40^\circ C \leq T_J \leq +85^\circ C$; unless noted

| Symbol | Parameter | Condition | Min | Typ | Max | Units |
|----------|----------------------------------------------|--------------------------|--------------|------|--------------|------------------|
| V_{OS} | Input Offset Voltage | | | 0.4 | 5 | mV |
| V_{OS} | Input Offset Voltage Temperature Coefficient | | | 1 | | $\mu V/^\circ C$ |
| I_B | Input Bias Current | | | 0.13 | 0.6 | μA |
| I_{OS} | Input Offset Current | | | 0.06 | 0.3 | μA |
| V_{CM} | Input Common-Mode Range | CMRR > 75dB | -7.25 | | +7.25 | V |
| CMRR | Common-Mode Rejection Ratio | $-2.5V < V_{CM} < +2.5V$ | 75 | 87 | | dB |

| Symbol | Parameter | Condition | Min | Typ | Max | Units |
|-----------|------------------------------|--------------------------------------------------------------------------------------------|-------------|------|-------------|---------------|
| PSRR | Power Supply Rejection Ratio | $\pm 3.5V < V_S < \pm 9V$ | 95 | 105 | | dB |
| A_{VOL} | Large-Signal Voltage Gain | $R_L = 2k, V_{OUT} = \pm 3V$ | 75 | 86 | | dB |
| | | $R_L = 100\Omega, V_{OUT} = \pm 1V$ | | 92 | | dB |
| V_{OUT} | Maximum Output Voltage Swing | positive, $R_L = 2k\Omega$ | +6.5 | 7.6 | | V |
| | | negative, $R_L = 2k\Omega$ | | -7.6 | -6.2 | V |
| GBW | Unity Gain-Bandwidth Product | $A_V = 1, C_L = 1.7pF$ | | 45 | | MHz |
| PM | Phase Margin | | | 40 | | ° |
| BW | -3dB Bandwidth | $A_V = 1, R_L = 1k\Omega, C_L = 1.7pF$ | | 61 | | MHz |
| SR | Slew Rate | $C = 1.7pF, \text{Gain} = 1, V_{OUT} = 5V, \text{peak to peak, negative SR} = 2500V/\mu s$ | | 3200 | | V/ μs |
| I_{SC} | Short-Circuit Output Current | source | 40 | 59 | | mA |
| | | sink | 25 | 45 | | mA |
| I_S | Supply Current | No Load | | 0.36 | 0.6 | mA |
| | Input Voltage Noise | $f = 10kHz$ | | 12 | | $nV\sqrt{Hz}$ |
| | Input Current Noise | $f = 10kHz$ | | 0.7 | | $pA\sqrt{Hz}$ |

Note 1. Exceeding the absolute maximum rating may damage the device.

Note 2. The device is not guaranteed to function outside its operating rating.

Note 3. Exceeding the maximum differential input voltage will damage the input stage and degrade performance (in particular, input bias current is likely to change).

Note 4. Devices are ESD sensitive. Handling precautions recommended. Human body model, 1.5k in series with 100pF.

Note 5. Output swing limited by the maximum output sink capability, refer to the short-circuit current vs. temperature graph in "Typical Characteristics."

Test Circuits

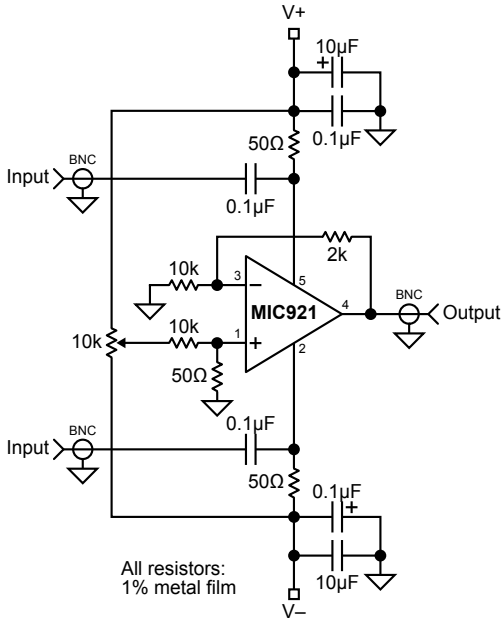

PSRR vs. Frequency

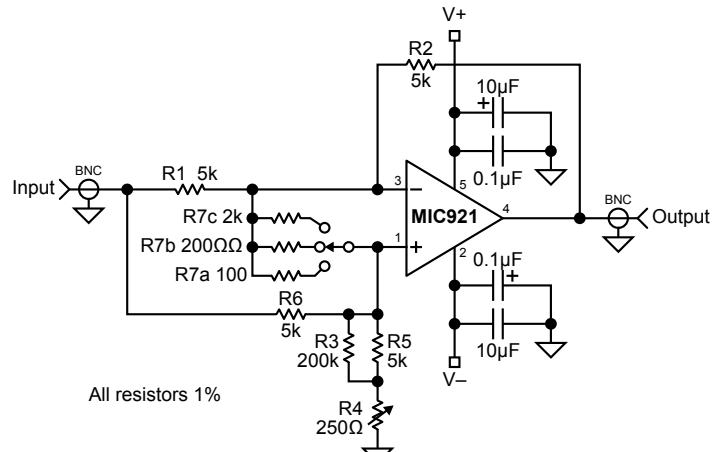

$$V_{OUT} = V_{ERROR} \left(1 + \frac{R2}{R1} + \frac{R2 + R5 + R4}{R7} \right)$$

CMRR vs. Frequency

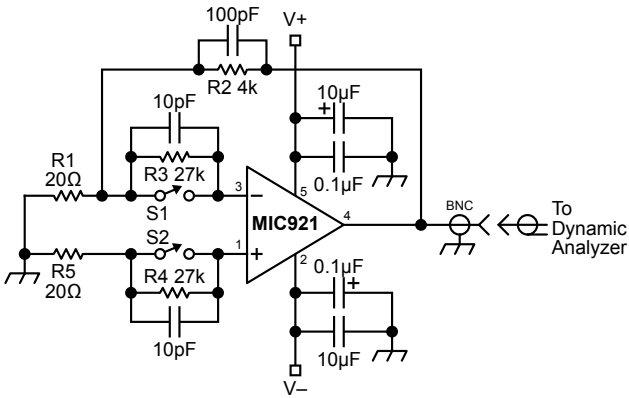

Noise Measurement

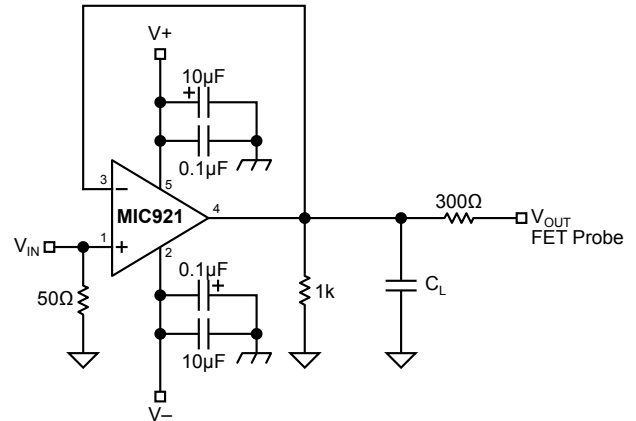

Closed Loop Frequency Response Measurement

Typical Characteristics

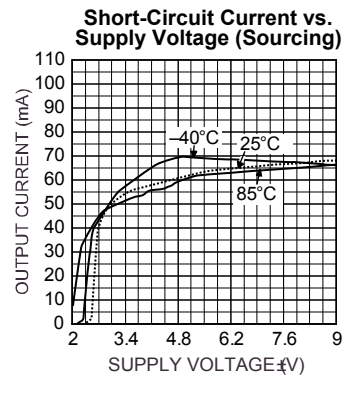
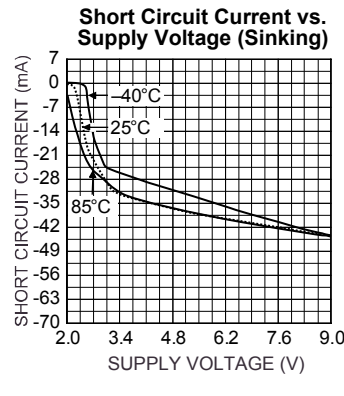
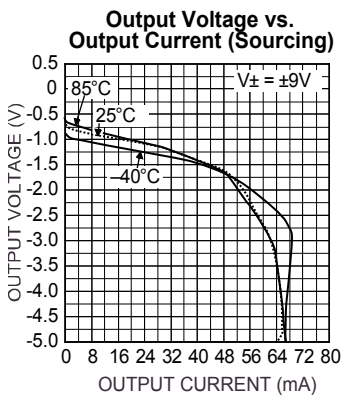
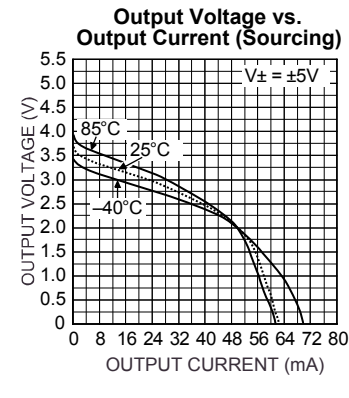
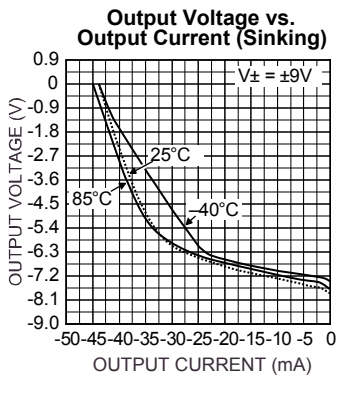
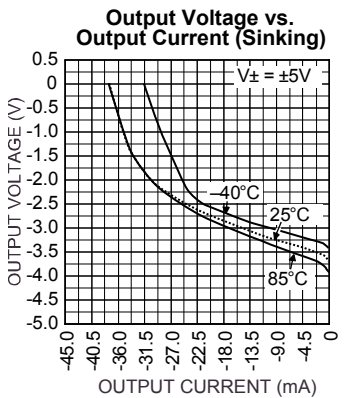
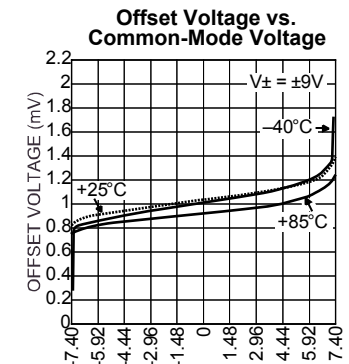
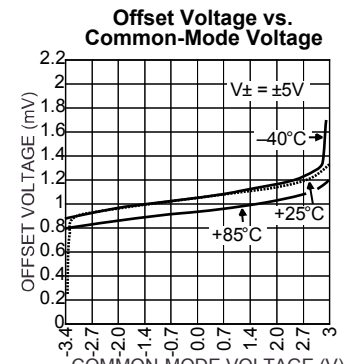
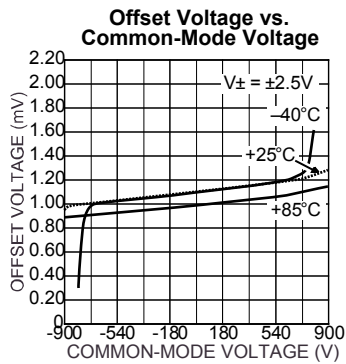
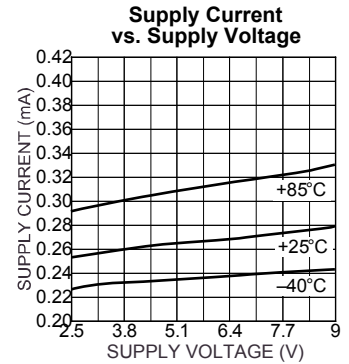
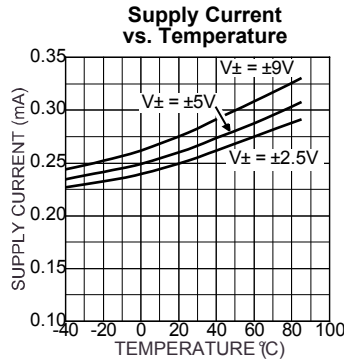
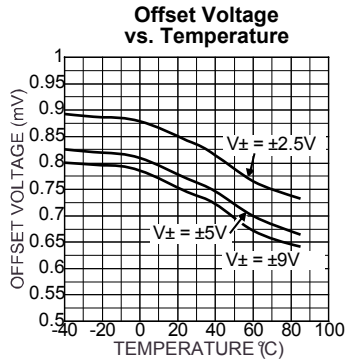

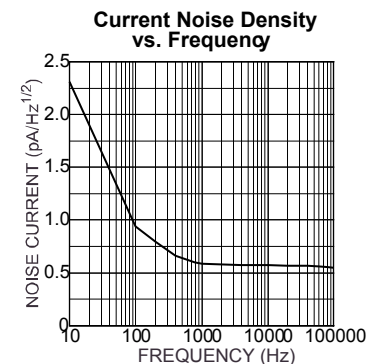
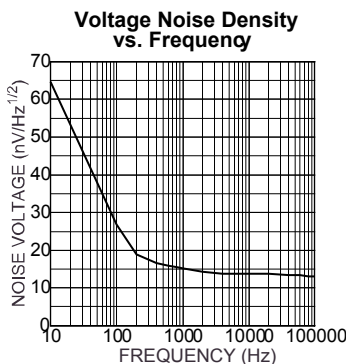
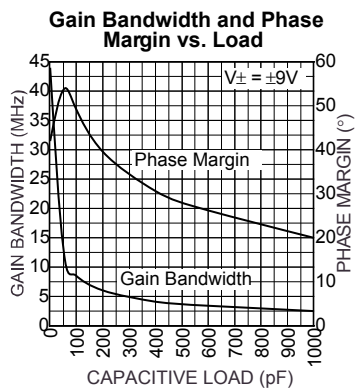
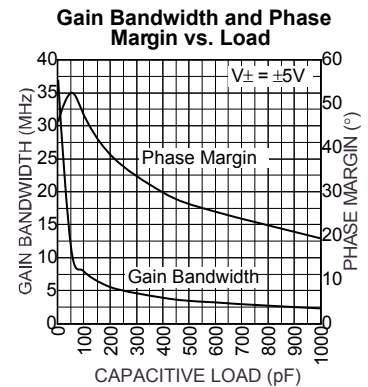
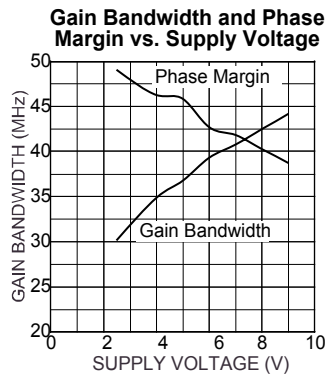
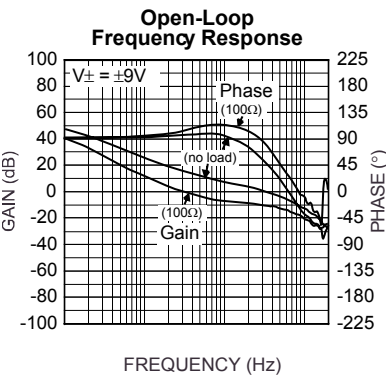
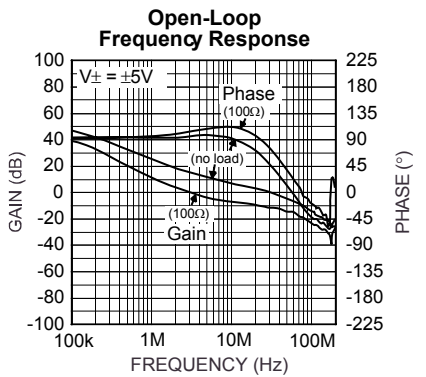
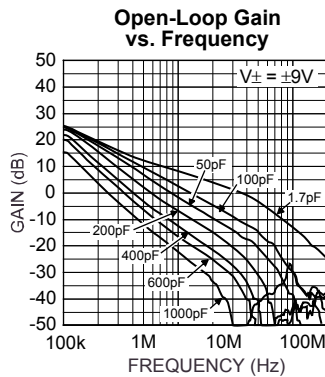
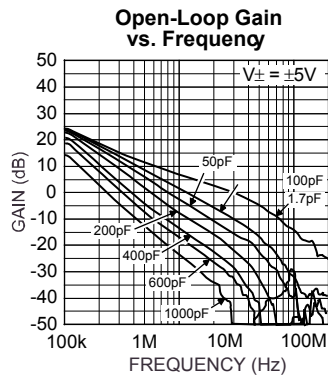
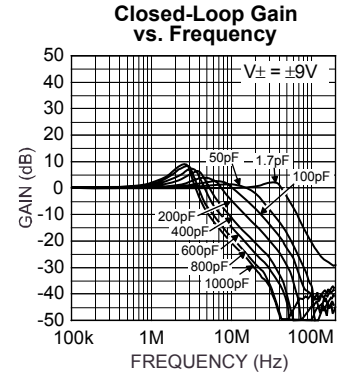
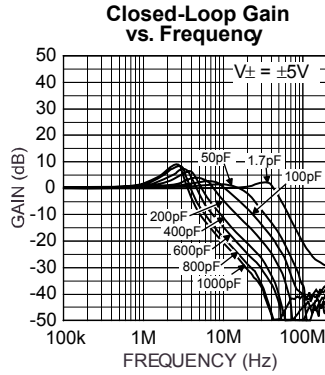
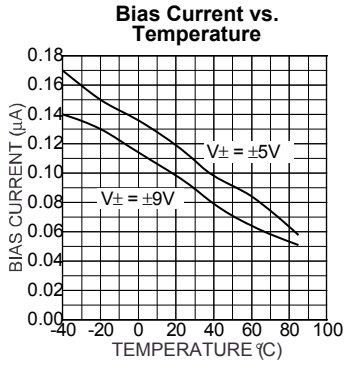

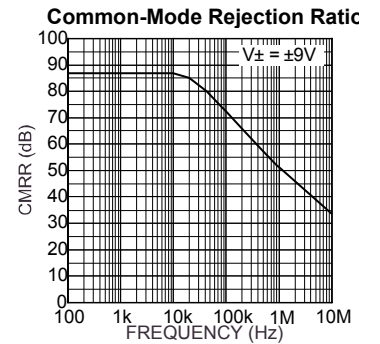
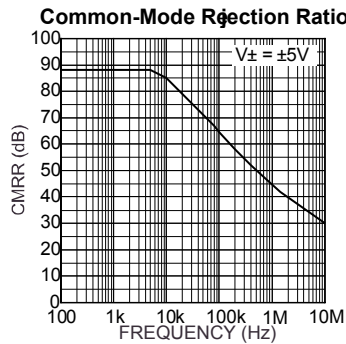
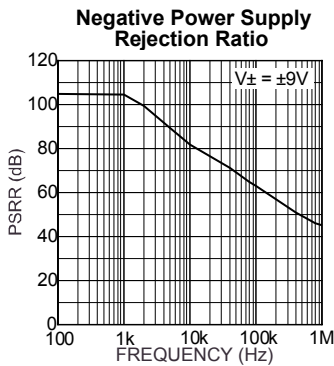
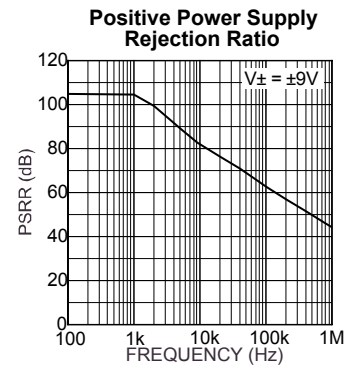
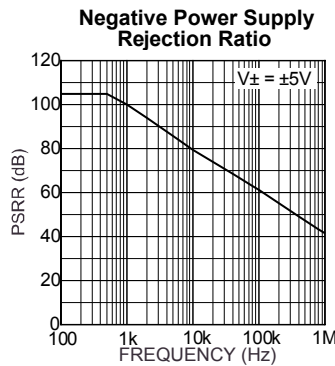
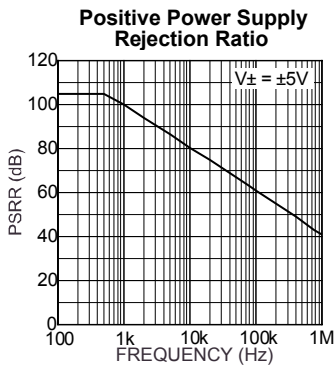
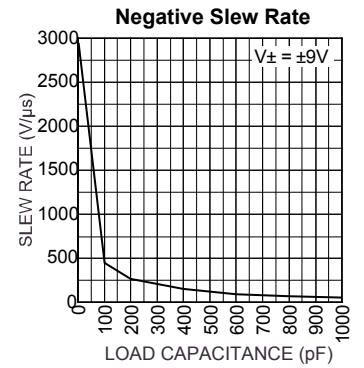
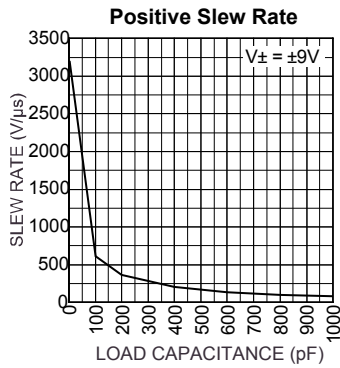
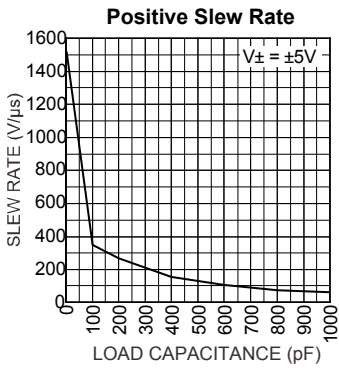
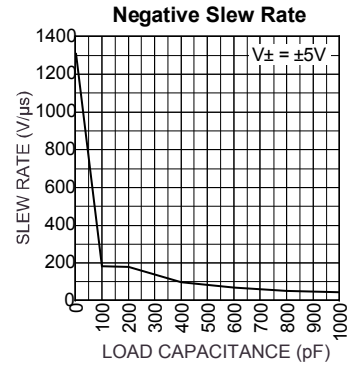
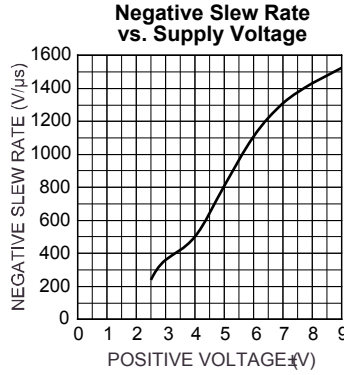
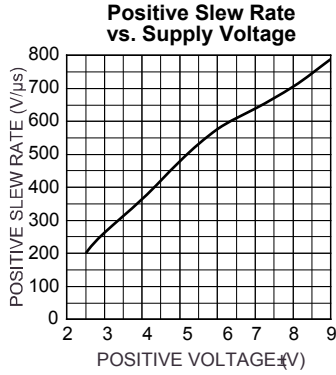

Functional Characteristics

Small Signal Reponse

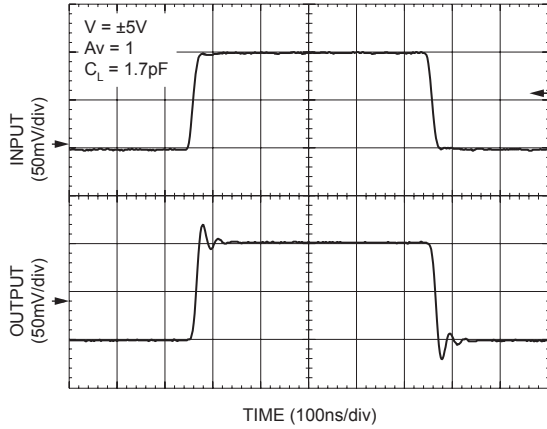

Small Signal Reponse

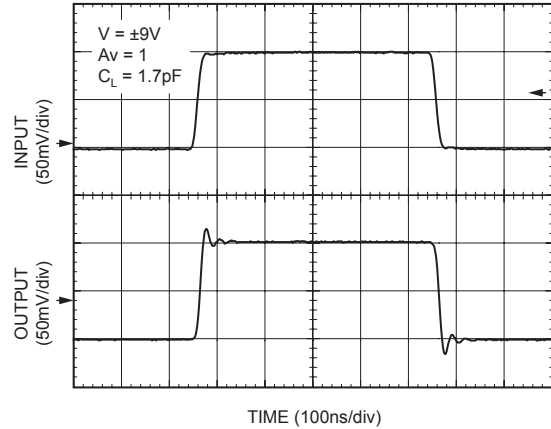

Small Signal Reponse

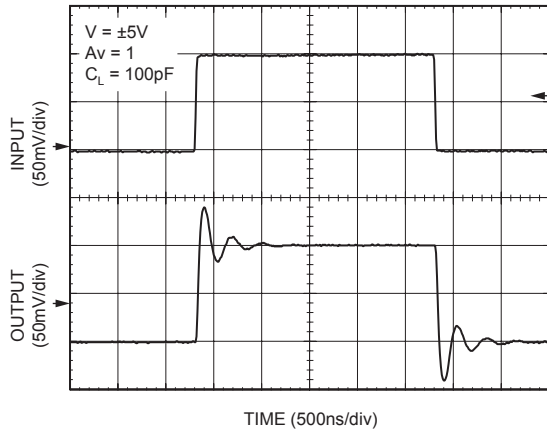

Small Signal Reponse

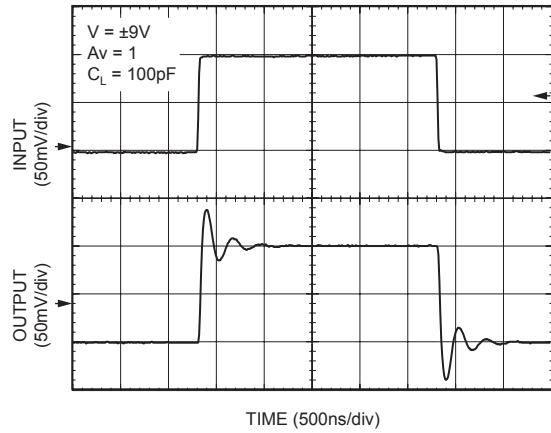

Small Signal Reponse

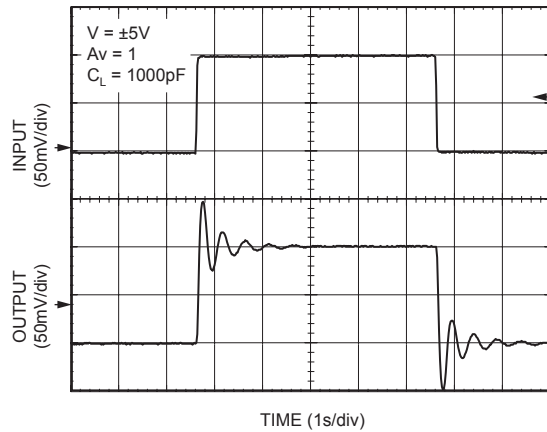

Small Signal Reponse

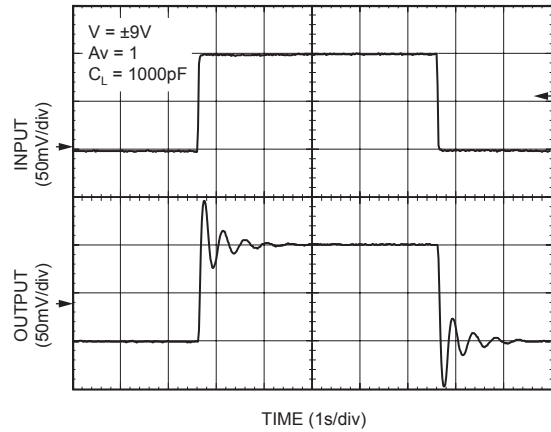

Large Signal Response

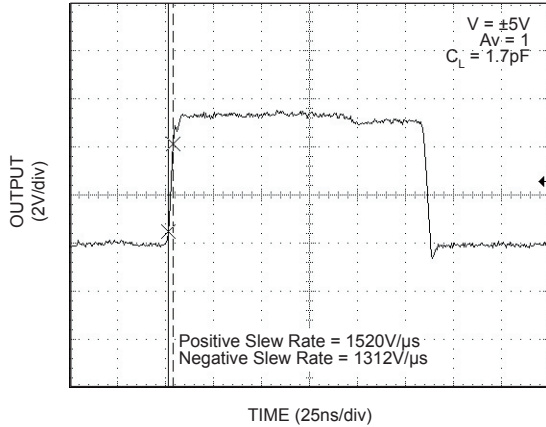

Large Signal Response

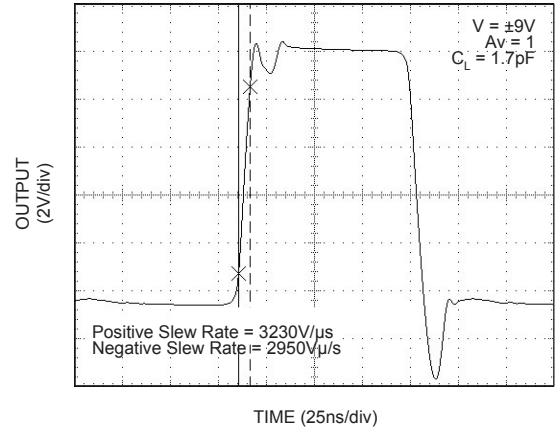

Large Signal Response

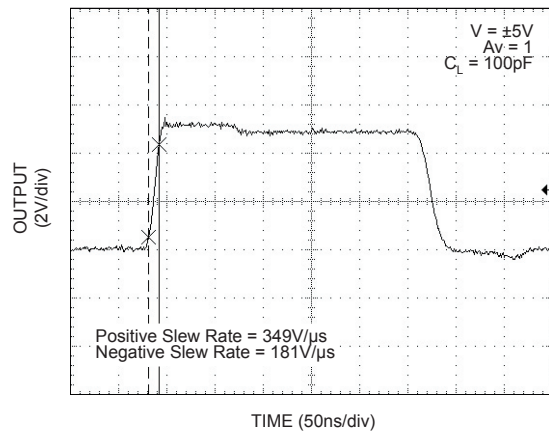

Large Signal Response

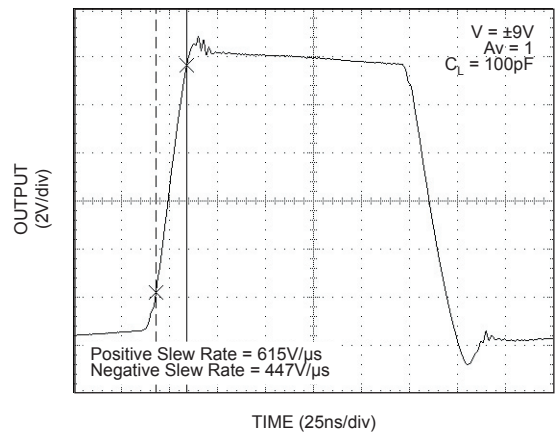

Large Signal Response

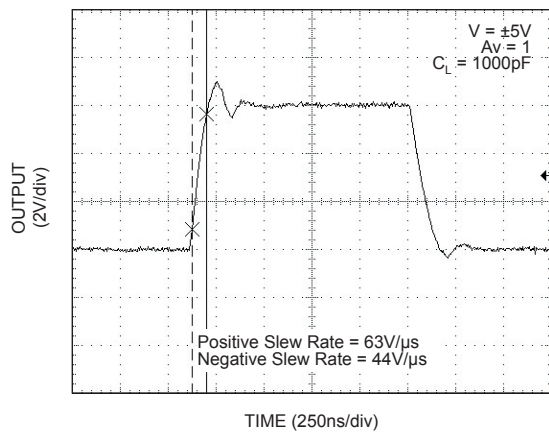

Large Signal Response

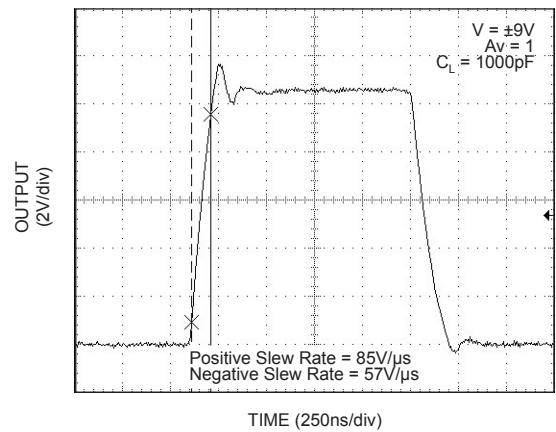

Applications Information

The MIC921 is a high-speed, voltage-feedback operational amplifier featuring very low supply current and excellent stability. This device is unity gain stable, capable of driving high capacitance loads.

Driving High Capacitance

The MIC921 is stable when driving high capacitance, making it ideal for driving long coaxial cables or other high-capacitance loads. Most high-speed op amps are only able to drive limited capacitance.

Note: increasing load capacitance does reduce the speed of the device. In applications where the load capacitance reduces the speed of the op amp to an unacceptable level, the effect of the load capacitance can be reduced by adding a small resistor (<100Ω) in series with the output.

Feedback Resistor Selection

Conventional op amp gain configurations and resistor selection apply, the MIC921 is NOT a current feedback device.

Also, for minimum peaking, the feedback resistor should have low parasitic capacitance, usually 470Ω is ideal. To use the part as a follower, the output should be connected to input via a short wire.

Layout Considerations

All high speed devices require careful PCB layout. The following guidelines should be observed: Capacitance, particularly on the two inputs pins will degrade performance; avoid large copper traces to the inputs. Keep the output signal away from the inputs and use a ground plane.

It is important to ensure adequate supply bypassing capacitors are located close to the device.

Power Supply Bypassing

Regular supply bypassing techniques are recommended. A 10μF capacitor in parallel with a 0.1μF capacitor on both the positive and negative supplies are ideal. For best performance all bypassing capacitors should be located as close to the op amp as possible and all capacitors should be low ESL (equivalent series inductance), ESR (equivalent series resistance). Surface-mount ceramic capacitors are ideal.

Thermal Considerations

The SC70-5 package, like all small packages, has a high thermal resistance. It is important to ensure the IC does not exceed the maximum operating junction (die) temperature of 85°C. The part can be operated up to the absolute maximum temperature rating of 125°C, but between 85°C and 125°C performance will degrade, in particular CMRR will reduce.

An MIC921 with no load, dissipates power equal to the quiescent supply current * supply voltage

$$P_{D(\text{no load})} = (V_{V+} - V_{V-}) I_S$$

When a load is added, the additional power is dissipated in the output stage of the op amp. The power dissipated in the device is a function of supply voltage, output voltage and output current.

$$P_{D(\text{output stage})} = (V_{V+} - V_{OUT}) I_{OUT}$$

$$\text{Total Power Dissipation} = P_{D(\text{no load})} + P_{D(\text{output stage})}$$

Ensure the total power dissipated in the device is no greater than the thermal capacity of the package. The SC70-5 package has a thermal resistance of 450°C/W.

$$\text{Max. Allowable Power Dissipation} = \frac{T_{J(\text{max})} - T_{A(\text{max})}}{450^\circ\text{C/W}}$$

Package Information

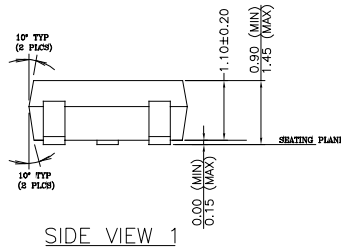
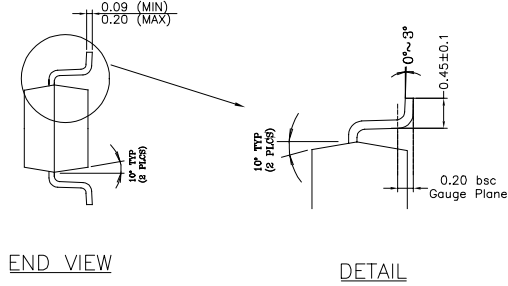
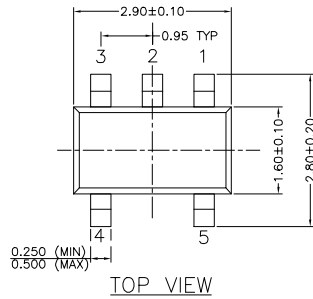

NOTE:
 1. PACKAGE OUTLINE EXCLUSIVE OF MOLD FLASH & BURR.
 2. PACKAGE OUTLINE INCLUSIVE OF SOLER PLATING.
 3. DIMENSION AND TOLERANCE PER ANSI Y14.5M, 1982.
 4. FOOT LENGTH MEASUREMENT BASED ON GAUGE PLANE METHOD.
 5. DIE FACES UP FOR MOLD, AND FACES DOWN FOR TRIM/FORM.

SOT-23-5 (M5)

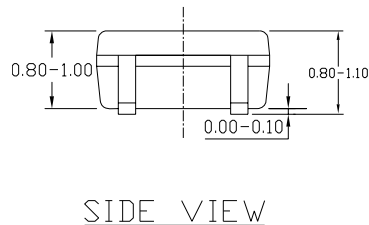
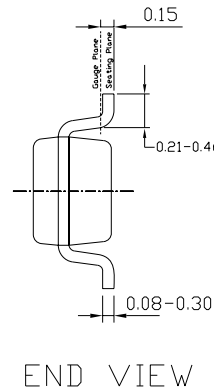
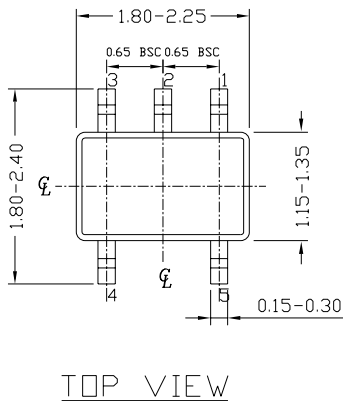

NOTE:
 1. ALL DIMENSIONS ARE IN MILLIMETERS.
 2. DIMENSIONS ARE INCLUSIVE OF PLATING.
 3. DIMENSIONS ARE EXCLUSIVE OF MOLD FLASH & METAL BURR.

SC-70 (C5)

MICREL INC. 2180 FORTUNE DRIVE SAN JOSE, CA 95131 USA
 TEL + 1 (408) 944-0800 FAX + 1 (408) 474-1000 WEB <http://www.micrel.com>

This information furnished by Micrel in this data sheet is believed to be accurate and reliable. However no responsibility is assumed by Micrel for its use. Micrel reserves the right to change circuitry and specifications at any time without notification to the customer.

Micrel Products are not designed or authorized for use as components in life support appliances, devices or systems where malfunction of a product can reasonably be expected to result in personal injury. Life support devices or systems are devices or systems that (a) are intended for surgical implant into the body or (b) support or sustain life, and whose failure to perform can be reasonably expected to result in a significant injury to the user. A Purchaser's use or sale of Micrel Products for use in life support appliances, devices or systems is a Purchaser's own risk and Purchaser agrees to fully indemnify Micrel for any damages resulting from such use or sale.