

# BUK221-50DY

Dual channel high-side TOPFET™

Rev. 01 — 16 April 2003

Product data

## 1. Product profile

### 1.1 Description

Monolithic temperature and overload protected dual high-side power switch based on TOPFET™ Trench technology in a 7-pin surface mount plastic package.

Product availability:

BUK221-50DY in SOT427 (D<sup>2</sup>-PAK).

### 1.2 Features

- Very low quiescent current
- Power TrenchMOS™
- Overtemperature protection
- Over and undervoltage protection
- Reverse battery protection
- Low charge pump noise
- Loss of ground protection
- Negative load clamping
- CMOS logic compatibility
- Current limitation
- Latched overload protection
- ESD protection for all pins
- Diagnostic status indication
- Off-state open load detection
- Load dump protection
- Internal ground resistor.

### 1.3 Applications

- 12 and 24 V grounded loads
- Inductive loads
- High inrush current loads
- Replacement for relays and fuses.

### 1.4 Quick reference data

Table 1: Quick reference data

Symbol	Parameter	Min	Max	Units
R <sub>BLon</sub>	battery-load on-state resistance	-	90	mΩ
I <sub>L</sub>	load current	-	4	A
I <sub>L(nom)</sub>	nominal load current (ISO)	3.6	-	A
I <sub>L(lim)</sub>	self-limiting load current	8	16	A
V <sub>BG(oper)</sub>	battery-ground operating voltage	5.5	35	V



PHILIPS

## 2. Pinning information

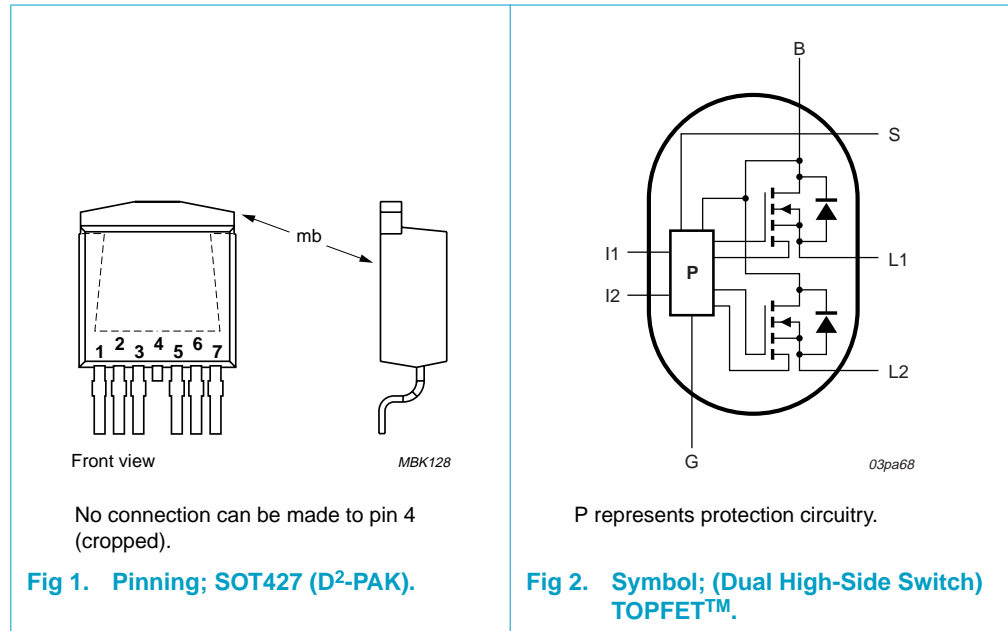

### 2.1 Pin description

Table 2: Pin description

Symbol	Pin	I/O	Description
L1	1	O	load 1
G	2	-	circuit common ground
I1	3	I	input 1
B	4	-	[1] [2] battery
S	5	O	status
I2	6	I	input 2
L2	7	O	load 2
-	mb	-	[2] mounting base

[1] Pin 4 is cropped and cannot be connected to the PCB by surface mounting.

[2] The battery is connected to the mounting base.

**3. Block diagram**

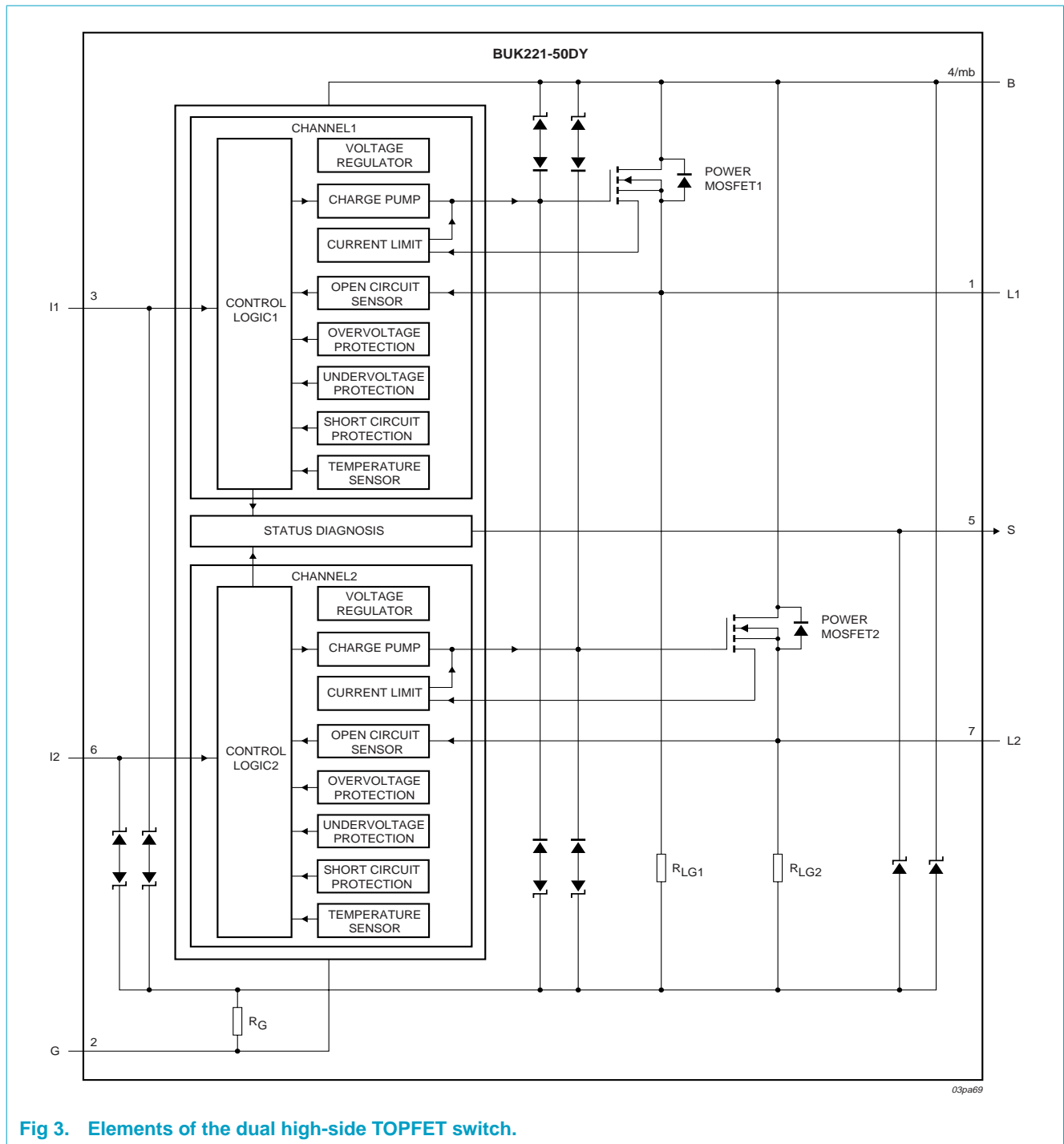

**Fig 3. Elements of the dual high-side TOPFET switch.**

## 4. Functional description

A diagnostic status ensures faster fault detection.

Active current limit is combined with latched short circuit protection in order to protect the device in the event of a short circuit.

Thermal shutdown for high temperature conditions has an automatic restart at a lower temperature so providing protection against excessive power dissipation.

Active clamping protects the device against low energy spikes.

Undervoltage lockout means the device shuts down for low battery voltages, thus avoiding faulty operation.

Overvoltage shutdown in the on-state protects a load such as a lamp filament from potentially destructive voltage spikes.

**Table 3: Truth table**

Abbreviations: L = logic LOW; H = logic HIGH; X = don't care; 0 = condition not present; 1 = condition present; UV = undervoltage; OV = overvoltage; OC = open circuit load; SC = short circuit; OT = overtemperature <sup>[1]</sup>.

Input		Supply		Load 1			Load 2			Load output		Status	Operating mode
1	2	UV	OV	OC	SC	OT	OC	SC	OT	1	2		
L	L	0	X	0	X	X	0	X	X	OFF	OFF	H	both off & normal
L	L	0	X	1	X	X	X	X	X	OFF	OFF	L	both off, one/both OC or shorted to V <sub>S</sub> or battery; <b>Figure 10</b>
L	H	0	X	1	X	X	0	0	0	OFF	ON	L	one off & OC, with other on & normal
H	L	0	0	0	0	0	0	0	0	ON	OFF	H	one on & normal, with other off & normal
H	H	0	0	0	0	0	0	0	0	ON	ON	H	both on & normal
H	X	1	0	X	X	X	0	X	X	OFF	OFF	H	supply undervoltage lockout
H	X	0	1	X	0	0	X	0	0	OFF	OFF	H	supply overvoltage shutdown
H	X	0	0	0	1	X	X	X	X	OFF	X	L	one SC tripped
H	L	0	0	0	1	X	0	0	X	OFF	OFF	L	one SC tripped, with other off & normal
H	H	0	0	0	1	X	0	0	0	OFF	ON	L	one SC tripped, with other on & normal
H	X	0	0	0	0	1	X	X	X	OFF	X	L	one OT shutdown
H	L	0	0	0	0	1	0	0	X	OFF	OFF	L	one OT shutdown, with other off & normal
H	H	0	0	0	0	1	0	0	0	OFF	ON	L	one OT shutdown, with other on & normal

[1] The status will continue to indicate OT (even if the input goes LOW) until the device cools below the reset threshold temperature. See "Overtemperature protection" characteristics in [Table 6 "Static characteristics"](#).

## 5. Limiting values

**Table 4: Limiting values**

In accordance with the Absolute Maximum Rating System (IEC 60134).

Symbol	Parameter	Conditions	Min	Max	Unit
$V_{BG}$	battery-ground supply voltage		[1] -	45	V
$I_L$	load current	$T_{mb} \leq 130\text{ °C}$	-	4	A
$P_{tot}$	total power dissipation	$T_{mb} \leq 25\text{ °C}$	-	44.6	W
$T_{stg}$	storage temperature		-55	+175	°C
$T_j$	junction temperature		-40	+150	°C
$T_{mb}$	mounting base temperature	during soldering ( $\leq 10\text{ s}$ )	-	260	°C
<b>Reverse battery voltage</b>					
$V_{BGR}$	reverse battery-ground supply voltage	$R_l \geq 3.3\text{ k}\Omega$ ; $R_{SS} \geq 3.3\text{ k}\Omega$ ; <b>Figure 10</b>	[2] -	16	V
$V_{BGRR}$	repetitive reverse battery-ground supply voltage		-	32	V
<b>Input current</b>					
$I_i$	input current		-5	+5	mA
$I_{IRM}$	repetitive peak input current	$\delta \leq 0.1$ ; $t_p = 300\text{ }\mu\text{s}$	-50	+50	mA
<b>Status current</b>					
$I_S$	status current		-5	+5	mA
$I_{SRM}$	repetitive peak status current	$\delta \leq 0.1$ ; $t_p = 300\text{ }\mu\text{s}$	-50	+50	mA
<b>Inductive load clamping</b>					
$E_{BL(CL)S}$	non-repetitive battery-load clamping energy	$T_j = 150\text{ °C}$ prior to turn-off; $V_{BG} = 13\text{ V}$ ; $I_L = 5\text{ A}$ ; (one channel) <b>Figure 13</b>	-	60	mJ
<b>Electrostatic discharge voltage</b>					
$V_{esd}$	electrostatic discharge voltage	Human Body Model 1; $C = 100\text{ pF}$ ; $R = 1.5\text{ k}\Omega$	-	2	kV

[1] The device will not be harmed by exposure to the maximum supply voltage, but normal operation is not possible because of overvoltage shutdown - see **Table 6 "Static characteristics"** for the operating range.

[2] Reverse battery voltage is only allowed with external resistors to limit the input and status currents to a safe value. The connected load must limit the reverse load current. The internal ground resistor limits the reverse battery ground current. See **Figure 10 "Typical dynamic response circuit diagram including reverse supply protection and open load detection."**

## 6. Thermal characteristics

**Table 5: Thermal characteristics**

Symbol	Parameter	Conditions	Min	Typ	Max	Unit
$R_{th(j-mb)}$	thermal resistance from junction to mounting base	per channel	-	4	5.6	K/W
		both channels	-	2	2.8	K/W
$R_{th(j-a)}$	thermal resistance from junction to ambient	mounted on printed circuit board; minimum footprint	-	50	-	K/W

## 7. Static characteristics

**Table 6: Static characteristics**

Limits are valid for  $-40\text{ °C} \leq T_{mb} \leq +150\text{ °C}$  and typical values for  $T_{mb} = 25\text{ °C}$  unless otherwise specified.

Symbol	Parameter	Conditions	Min	Typ	Max	Unit	
<b>Clamping voltage</b>							
$V_{BG(CL)}$	battery-ground clamping voltage	$I_G = 1\text{ mA}$	45	55	65	V	
$V_{BL(CL)}$	battery-load clamping voltage	$I_L = I_G = 1\text{ mA}$	50	55	65	V	
$V_{LG(CL)}$	load-ground clamping voltage	$I_L = 10\text{ mA}$ ; <b>Figure 13</b>	[1]	-18	-23	-28	V
		$I_L = 4\text{ A}$ ; $t_p = 300\text{ }\mu\text{s}$	-20	-25	-30	V	
<b>Supply voltage</b>							
$V_{BG(oper)}$	battery-ground operating voltage		5.5	-	35	V	
<b>Current [2]</b>							
$I_B$	battery quiescent current	$V_{LG} = V_{IG} = 0\text{ V}$ ; <b>Figure 9</b>	[3]				
		$T_{mb} = 150\text{ °C}$	-	-	20	$\mu\text{A}$	
		$T_{mb} = 25\text{ °C}$	-	0.1	1	$\mu\text{A}$	
$I_{L(off)}$	off-state load current	$V_{BL} = V_{BG}$ ; per channel					
		$T_{mb} = 150\text{ °C}$	-	-	10	$\mu\text{A}$	
		$T_{mb} = 25\text{ °C}$	-	0.1	1	$\mu\text{A}$	
$I_{G(on)}$	operating current	one channel on; <b>Figure 5</b>	-	2	3	mA	
		both channels on	-	4	6	mA	
$I_{L(nom)}$	nominal load current (ISO)	$V_{BL} = 0.5\text{ V}$ ; $T_{mb} = 85\text{ °C}$	[4]	3.6	-	A	
<b>Resistance</b>							
$R_{BLon}$	battery-load on-state resistance	$9 \leq V_{BG} \leq 35\text{ V}$ ; $I_L = 4\text{ A}$ ; <b>Figure 4</b>	[5]				
		$T_{mb} = 25\text{ °C}$	-	73	90	m $\Omega$	
		$T_{mb} = 150\text{ °C}$	-	146	180	m $\Omega$	
		$V_{BG} = 5.5\text{ V}$ ; $I_L = 4\text{ A}$					
		$T_{mb} = 25\text{ °C}$	-	76	120	m $\Omega$	
		$T_{mb} = 150\text{ °C}$	-	150	240	m $\Omega$	
$R_G$	ground resistor	$I_G = -200\text{ mA}$ ; $t_p = 300\text{ }\mu\text{s}$	[6]	40	75	$\Omega$	
<b>Input [7]</b>							
$I_I$	input current	$V_{IG} = 5\text{ V}$		20	60	160	$\mu\text{A}$
$V_{IG(CL)}$	input-ground clamping voltage	$I_I = 200\text{ }\mu\text{A}$		5.5	7	8.5	V
$V_{IG(on)}$	input-ground turn-on voltage	<b>Figure 8</b>		-	2.1	3	V
$V_{IG(off)}$	input-ground turn-off voltage			1.2	1.8	-	V
$V_{IG(on)(hys)}$	input-ground turn-on hysteresis			0.15	0.3	0.5	V
$I_{I(on)}$	input turn-on current	$V_{IG} = 3\text{ V}$		-	-	100	$\mu\text{A}$
$I_{I(off)}$	input turn-off current	$V_{IG} = 1.2\text{ V}$		12	-	-	$\mu\text{A}$
<b>Open current detection [8][9]</b>							
$V_{LG(oc)}$	load-ground open circuit voltage	$V_{BG} \geq 9\text{ V}$		1.5	2.5	3.5	V
$I_{G(oc)}$	open-circuit operating current	$V_{BG} = V_{LG} = 16\text{ V}$ open load detected; other channel is off		-	0.8	1.5	mA

**Table 6: Static characteristics...continued**Limits are valid for  $-40\text{ °C} \leq T_{mb} \leq +150\text{ °C}$  and typical values for  $T_{mb} = 25\text{ °C}$  unless otherwise specified.

Symbol	Parameter	Conditions	Min	Typ	Max	Unit
$I_{L(oc)}$	load open circuit current	$V_{LG} = 3.5\text{ V}$ ; per channel	-	-22	-40	$\mu\text{A}$
		$V_{LG} = 16\text{ V}$ ; per channel	-	-200	-300	$\mu\text{A}$
$R_{L(oc)}$	open circuit load resistor	$V_S = 5\text{ V}$ ; connected externally; per channel; <b>Figure 10</b>	-	10	-	$\text{k}\Omega$
<b>Undervoltage</b> [9]						
$V_{BG(uv)}$	battery-ground undervoltage		[11]	2	4.2	5.3 V
$V_{BG(uv)(hys)}$	battery-ground undervoltage hysteresis		-	0.5	1.5	V
<b>Overvoltage</b> [9]						
$V_{BG(ov)}$	battery-ground overvoltage		[12]	35	40	45 V
$V_{BG(ov)(hys)}$	battery-ground overvoltage hysteresis		0.2	1	2	V
$I_{G(ov)}$	overvoltage operating current	$V_{BG} = 45\text{ V}$ ; per channel	-	1	2.5	mA
<b>Overload protection</b>						
$I_{L(lim)}$	self-limiting load current	$V_{BG} \geq 8\text{ V}$ ; $V_{BL} = V_{BG}$ ; <b>Figure 7</b>	8	12	16	A
<b>Overtemperature protection</b> [9][10]						
$T_{j(th)}$	threshold junction temperature		[13]	150	170	190 °C
$T_{j(th)(hys)}$	threshold junction temperature hysteresis		3	10	20	°C
<b>Status</b> [9]						
$V_{SG(CL)}$	status-ground clamping voltage	$I_S = 100\text{ }\mu\text{A}$	5.5	7	8.5	V
$V_{SG(L)}$	status-ground low voltage	$I_S = 100\text{ }\mu\text{A}$ ; <b>Figure 6</b>	-	0.7	0.9	V
		$I_S = 250\text{ }\mu\text{A}$	-	-	1.1	V
$I_{S(off)}$	status leakage current	$V_{SG} = 5\text{ V}$				
		$T_{mb} = 150\text{ °C}$	-	-	10	$\mu\text{A}$
		$T_{mb} = 25\text{ °C}$	-	0.1	1	$\mu\text{A}$
$R_S$	status resistor	$V_{SG} = 5\text{ V}$ ; connected externally; <b>Figure 10</b>	[14]	-	47	- $\text{k}\Omega$

[1] For a high-side switch, the load pin voltage goes negative with respect to the ground during the turn-off of an inductive load. This negative voltage is clamped by the device.

[2]  $9\text{ V} \leq V_{BG} \leq 35\text{ V}$

[3] This is the current drawn from the supply when both inputs are LOW, and includes leakage current to the loads.

[4] Defined as in ISO10483-1. For comparison purposes only.

[5] This only applies to the  $R_{BLon}$  per channel. The supply and input voltages for the  $R_{BLon}$  tests are continuous. The specified pulse duration is  $t_p = 300\text{ }\mu\text{s}$ , and refers only to the applied load current.

[6]  $R_G$  is a resistor incorporated internally into the package.

[7]  $5.5\text{ V} \leq V_{BG} \leq 35\text{ V}$

[8] An open circuit load can be detected in the off-state and requires an external pull-up resistor,  $R_{L(oc)}$ .

[9] See **Table 3 "Truth table"**

[10] Overtemperature protection is not active during reverse current operation.

[11] Undervoltage sensor causes each output channel to switch off and reset.

[12] Overvoltage sensor causes each output channel to switch off to protect the load.

[13] After cooling below the reset temperature the channel will resume normal operation.

[14] The status output is an open drain transistor and requires an external pull-up resistor,  $R_S$ , to indicate a logic HIGH.

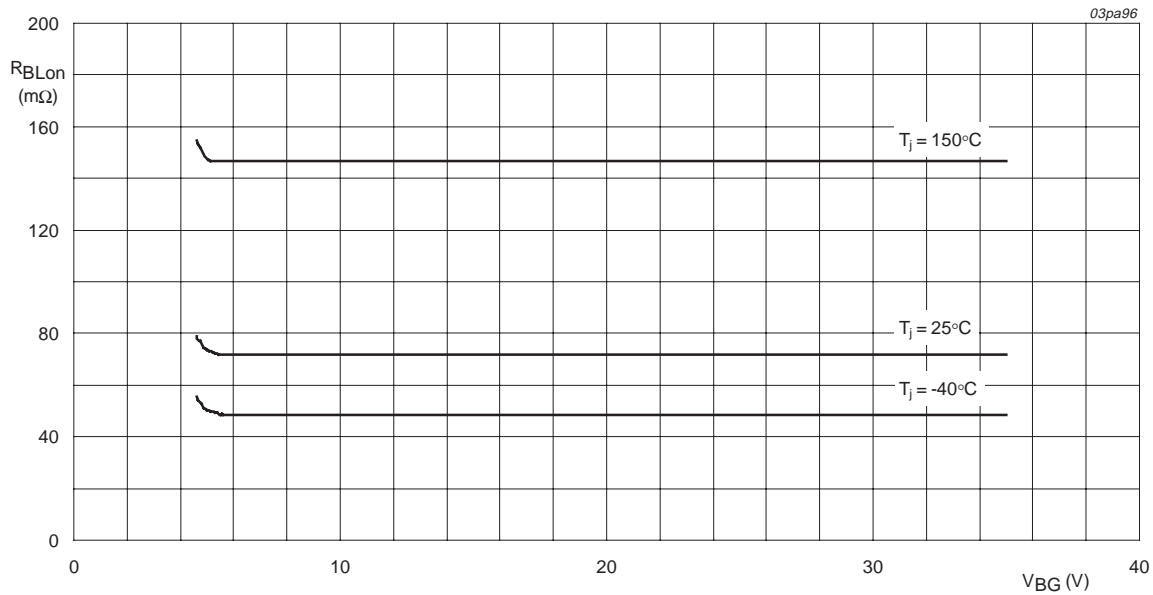

$I_L = 4 \text{ A}; V_{IG} = 5 \text{ V}$

Fig 4. Battery-load on-state resistance as a function of battery-ground voltage; typical values.

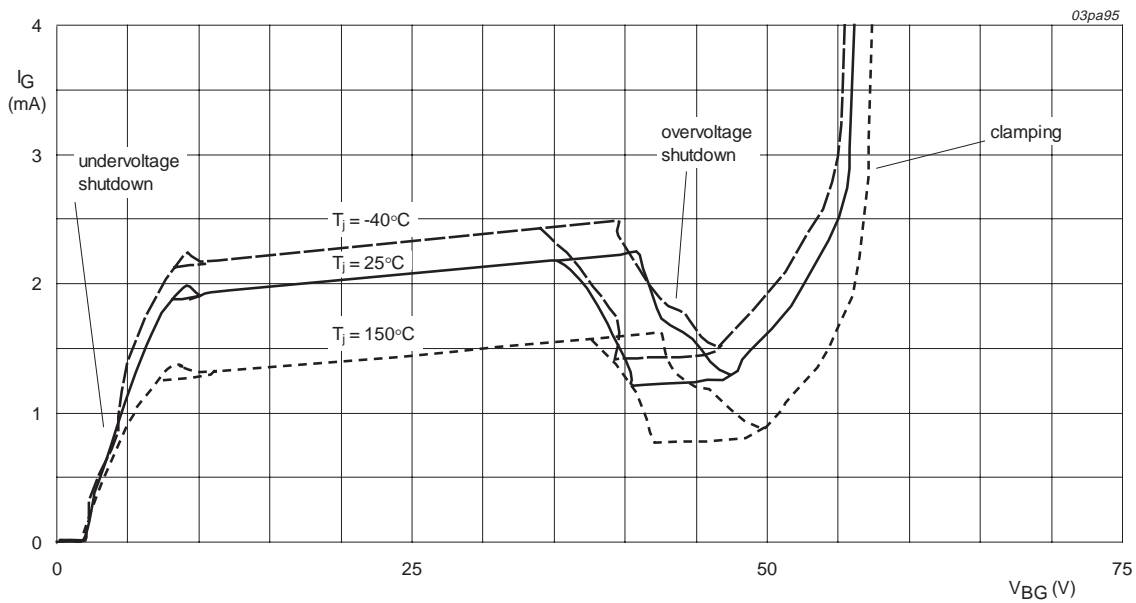

$V_{IG} = 5 \text{ V}$

Fig 5. Supply current characteristics: operating current as a function of battery-ground voltage for one channel only; typical values.



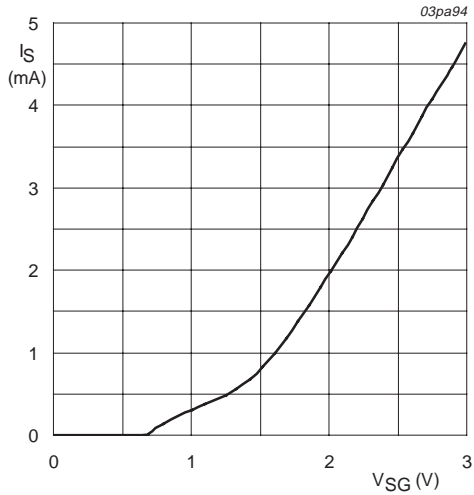

$V_{BG} = 13$  V;  $V_{IG} = 5$  V;  $T_j = 25$  °C

**Fig 6. Status current as a function of status-ground voltage; typical values.**

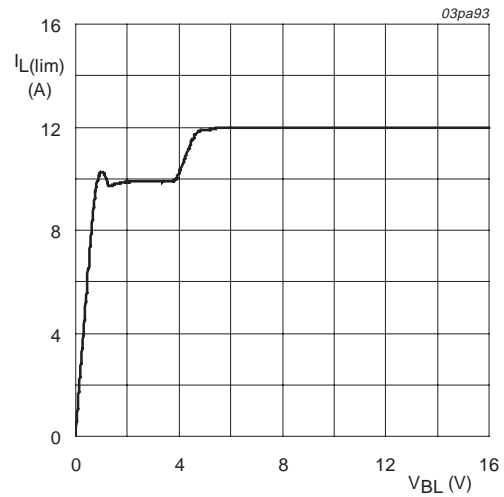

$V_{BG} = 16$  V;  $V_{IG} = 5$  V;  $T_{mb} = 25$  °C

**Fig 7. Self-limiting load current as a function of battery-load voltage; typical values.**

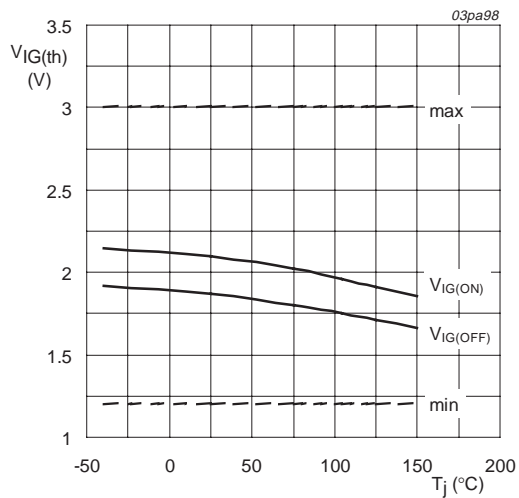

$5.5$  V  $\leq V_{BG} \leq 35$  V

**Fig 8. Input-ground threshold voltage as a function of junction temperature.**

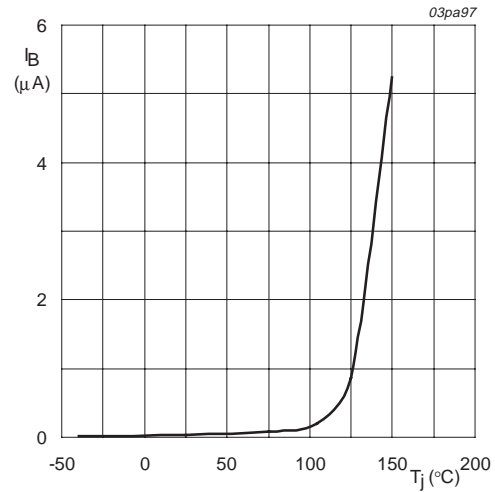

$V_{BG} = 35$  V

**Fig 9. Battery quiescent current as a function of junction temperature; typical values.**

## 8. Dynamic characteristics

**Table 7: Switching characteristics**

$T_{mb} = 25\text{ }^\circ\text{C}$ ;  $V_{BG} = 13\text{ V}$ ; resistive load  $R_L = 13\text{ }\Omega$  per channel; **Figure 12**.

Symbol	Parameter	Conditions	Min	Typ	Max	Unit
<b>Turn-on measured from the input going HIGH</b>						
$t_{d(on)}$	turn-on delay time	to 10 % $V_L$	-	30	-	$\mu\text{s}$
$dV/dt_{on}$	rising slew rate	30 to 70 % $V_L$	0.5	1	2	$\text{V}/\mu\text{s}$
$t_{on}$	turn-on switching time	to 90 % $V_L$	-	60	220	$\mu\text{s}$
<b>Turn-off measured from the input going LOW</b>						
$t_{d(off)}$	turn-off delay time	to 90 % $V_L$	-	20	-	$\mu\text{s}$
$dV/dt_{off}$	falling slew rate	70 to 30 % $V_L$	0.5	1	2	$\text{V}/\mu\text{s}$
$t_{off}$	turn-off switching time	to 10 % $V_L$	-	40	200	$\mu\text{s}$

**Table 8: Capacitances**

$T_{mb} = 25\text{ }^\circ\text{C}$ ;  $f = 1\text{ MHz}$ ;  $V_{IG} = 0\text{ V}$ .

Symbol	Parameter	Conditions	Min	Typ	Max	Unit
$C_{sg}$	status-ground capacitance	$V_{SG} = 5\text{ V}$	-	11	15	$\text{pF}$
<b>Per channel</b>						
$C_{ig}$	input-ground capacitance	$V_{BG} = 13\text{ V}$	-	15	20	$\text{pF}$
$C_{bl}$	battery-load capacitance	$V_{BL} = 13\text{ V}$	-	130	180	$\text{pF}$

**Table 9: Short circuit load protection characteristics**

$T_{mb} \leq 125\text{ }^\circ\text{C}$  prior to the overload short circuit condition.

Symbol	Parameter	Conditions	Min	Typ	Max	Unit	
$P_{BL(OV)(th)}$	battery-load overload power threshold	$5.5 \leq V_{BG} \leq 35\text{ V}$ ; device trips if $P_{BL} > P_{BL(OV)(th)}$ ; <b>Figure 11</b>	[1]	10	55	100	W
$t_{BL(d)(sc)}$	battery-load short-circuit characteristic time	$P_{BL} > P_{BL(OV)(th)}$ ; <b>Figure 11</b>	[2]	200	350	800	$\mu\text{s}$

[1] Short circuit protection is latched, but at high temperatures where  $T_j > T_{j(th)}$  overtemperature protection may occur first. Normal operation may only be resumed following a short circuit after the input is toggled LOW then HIGH again.

[2] Short circuit response time  $t_{d(sc)}$  varies with battery-load power  $P_{BL}$  according to the **logarithmic model** equation:

$$t_{d(sc)} \approx \frac{t_{BL(d)(sc)}}{\ln\left(\frac{P_{BL}}{P_{BL(OV)(th)}}\right)}$$

**Table 10: Status response times**

Limits are valid for  $-40\text{ }^\circ\text{C} \leq T_{mb} \leq +150\text{ }^\circ\text{C}$  and typical values for  $T_{mb} = 25\text{ }^\circ\text{C}$  unless otherwise specified.

Symbol	Parameter	Conditions	Min	Typ	Max	Unit
<b>Measured from when the input goes LOW to when the status goes LOW</b>						
$t_{d(oc)}$	open-circuit response time	<b>Figure 10 and 14</b>	-	65	100	$\mu\text{s}$

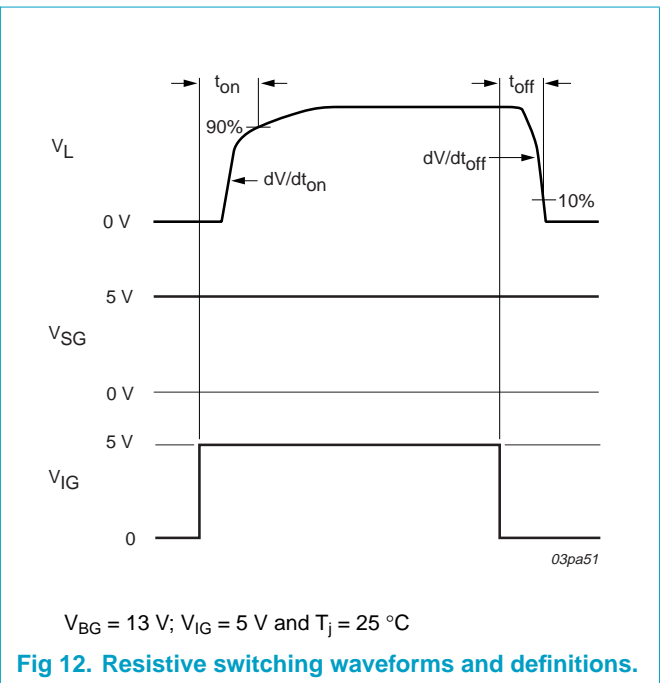
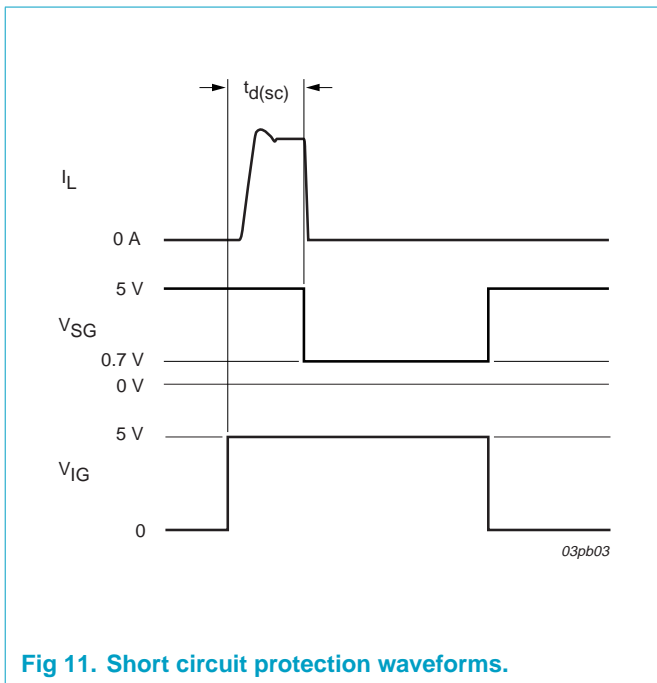
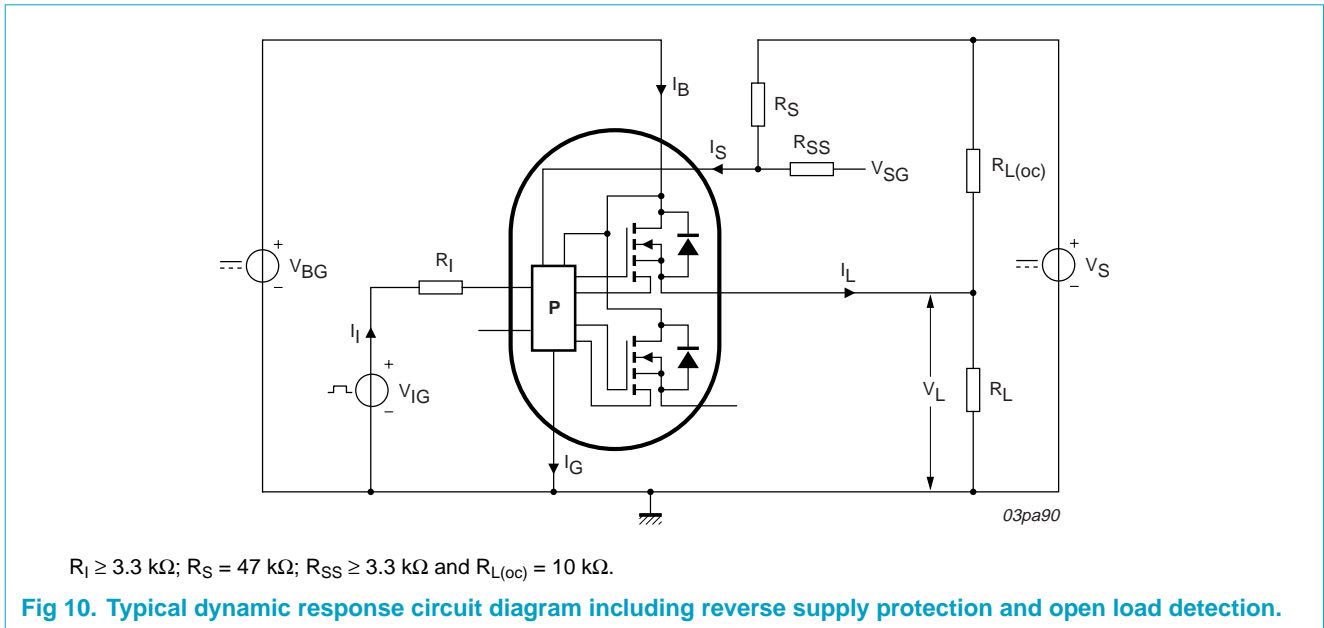

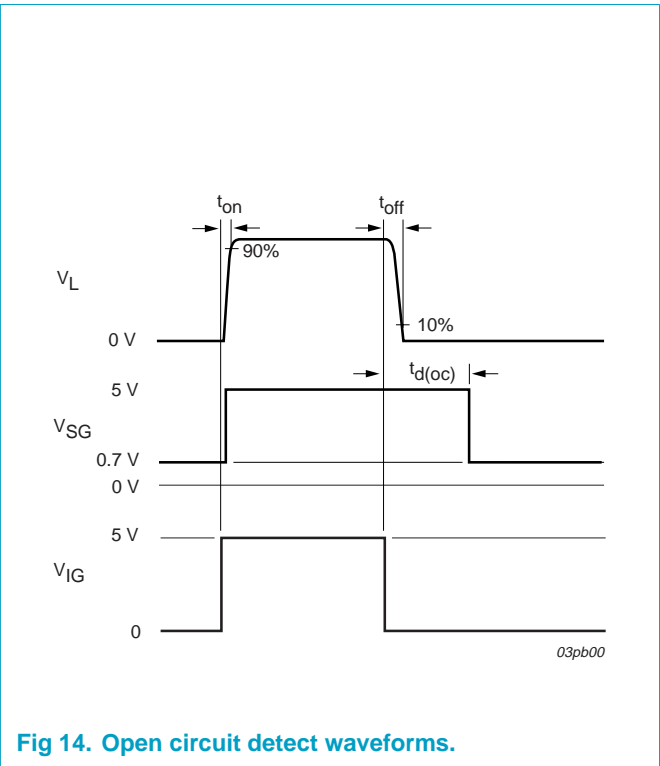
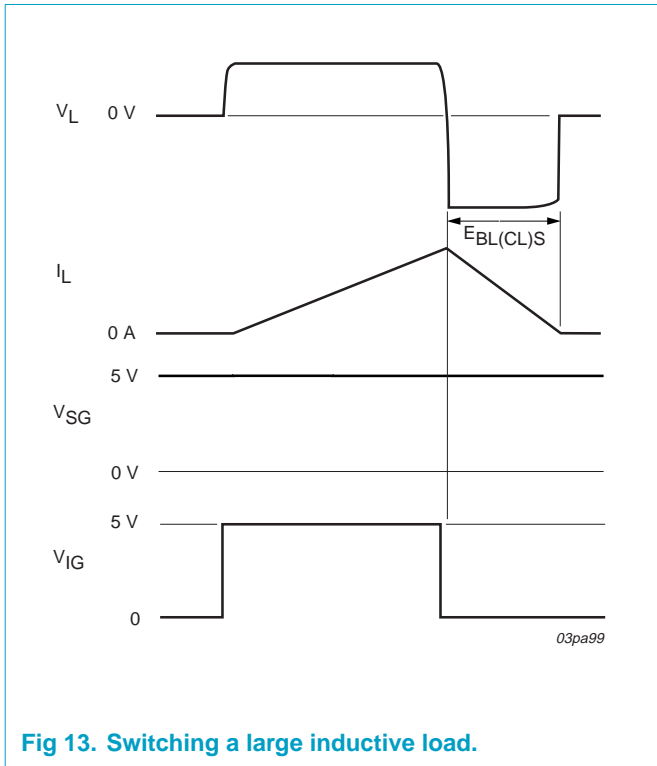

**9. Package outline**

Plastic single-ended surface mounted package (Philips version of D<sup>2</sup>-PAK);  
7 leads (one lead cropped)

SOT427

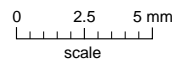
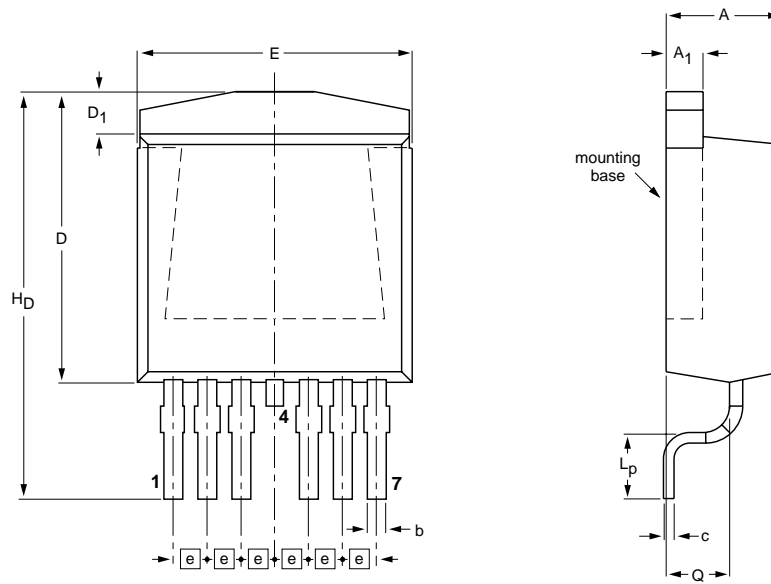

DIMENSIONS (mm are the original dimensions)

UNIT	A	A <sub>1</sub>	b	c	D max.	D <sub>1</sub>	E	e	L <sub>p</sub>	H <sub>D</sub>	Q
mm	4.50 4.10	1.40 1.27	0.85 0.60	0.64 0.46	11	1.60 1.20	10.30 9.70	1.27	2.90 2.10	15.80 14.80	2.60 2.20

OUTLINE VERSION	REFERENCES				EUROPEAN PROJECTION	ISSUE DATE
	IEC	JEDEC	EIAJ			
SOT427						99-06-25 01-04-18

Epoxy meets UL94 V0 at 1/8". Net mass: 1.5g. For soldering guidelines and surface mount footprint design, please refer to Data Handbook SC18.

**Fig 15. SOT427 (D<sup>2</sup>-PAK).**

## 10. Revision history

---

Table 11: Revision history

Rev	Date	CPCN	Description
01	20030416	-	Product data (9397 750 11167)

---

## 11. Data sheet status

Level	Data sheet status <sup>[1]</sup>	Product status <sup>[2][3]</sup>	Definition
I	Objective data	Development	This data sheet contains data from the objective specification for product development. Philips Semiconductors reserves the right to change the specification in any manner without notice.
II	Preliminary data	Qualification	This data sheet contains data from the preliminary specification. Supplementary data will be published at a later date. Philips Semiconductors reserves the right to change the specification without notice, in order to improve the design and supply the best possible product.
III	Product data	Production	This data sheet contains data from the product specification. Philips Semiconductors reserves the right to make changes at any time in order to improve the design, manufacturing and supply. Relevant changes will be communicated via a Customer Product/Process Change Notification (CPCN).

[1] Please consult the most recently issued data sheet before initiating or completing a design.

[2] The product status of the device(s) described in this data sheet may have changed since this data sheet was published. The latest information is available on the Internet at URL <http://www.semiconductors.philips.com>.

[3] For data sheets describing multiple type numbers, the highest-level product status determines the data sheet status.

## 12. Definitions

**Short-form specification** — The data in a short-form specification is extracted from a full data sheet with the same type number and title. For detailed information see the relevant data sheet or data handbook.

**Limiting values definition** — Limiting values given are in accordance with the Absolute Maximum Rating System (IEC 60134). Stress above one or more of the limiting values may cause permanent damage to the device. These are stress ratings only and operation of the device at these or at any other conditions above those given in the Characteristics sections of the specification is not implied. Exposure to limiting values for extended periods may affect device reliability.

**Application information** — Applications that are described herein for any of these products are for illustrative purposes only. Philips Semiconductors make no representation or warranty that such applications will be suitable for the specified use without further testing or modification.

## 13. Disclaimers

**Life support** — These products are not designed for use in life support appliances, devices, or systems where malfunction of these products can reasonably be expected to result in personal injury. Philips Semiconductors

customers using or selling these products for use in such applications do so at their own risk and agree to fully indemnify Philips Semiconductors for any damages resulting from such application.

**Right to make changes** — Philips Semiconductors reserves the right to make changes in the products - including circuits, standard cells, and/or software - described or contained herein in order to improve design and/or performance. When the product is in full production (status 'Production'), relevant changes will be communicated via a Customer Product/Process Change Notification (CPCN). Philips Semiconductors assumes no responsibility or liability for the use of any of these products, conveys no licence or title under any patent, copyright, or mask work right to these products, and makes no representations or warranties that these products are free from patent, copyright, or mask work right infringement, unless otherwise specified.

## 14. Trademarks

**TOPFET** — is a trademark of Koninklijke Philips Electronics N.V.

**TrenchMOS** — is a trademark of Koninklijke Philips Electronics N.V.

## Contact information

For additional information, please visit <http://www.semiconductors.philips.com>.

For sales office addresses, send e-mail to: [sales.addresses@www.semiconductors.philips.com](mailto:sales.addresses@www.semiconductors.philips.com).

Fax: +31 40 27 24825

## Contents

<b>1</b>	<b>Product profile</b> .....	<b>1</b>
1.1	Description .....	1
1.2	Features .....	1
1.3	Applications .....	1
1.4	Quick reference data .....	1
<b>2</b>	<b>Pinning information</b> .....	<b>2</b>
2.1	Pin description .....	2
<b>3</b>	<b>Block diagram</b> .....	<b>3</b>
<b>4</b>	<b>Functional description</b> .....	<b>4</b>
<b>5</b>	<b>Limiting values</b> .....	<b>5</b>
<b>6</b>	<b>Thermal characteristics</b> .....	<b>5</b>
<b>7</b>	<b>Static characteristics</b> .....	<b>6</b>
<b>8</b>	<b>Dynamic characteristics</b> .....	<b>10</b>
<b>9</b>	<b>Package outline</b> .....	<b>13</b>
<b>10</b>	<b>Revision history</b> .....	<b>14</b>
<b>11</b>	<b>Data sheet status</b> .....	<b>15</b>
<b>12</b>	<b>Definitions</b> .....	<b>15</b>
<b>13</b>	<b>Disclaimers</b> .....	<b>15</b>
<b>14</b>	<b>Trademarks</b> .....	<b>15</b>

© Koninklijke Philips Electronics N.V. 2003.  
Printed in The Netherlands

All rights are reserved. Reproduction in whole or in part is prohibited without the prior written consent of the copyright owner.

The information presented in this document does not form part of any quotation or contract, is believed to be accurate and reliable and may be changed without notice. No liability will be accepted by the publisher for any consequence of its use. Publication thereof does not convey nor imply any license under patent- or other industrial or intellectual property rights.

Date of release: 16 April 2003

Document order number: 9397 750 11167



# PHILIPS

*Let's make things better.*