

### General Description

The MIC47300 is a high-bandwidth, low-dropout, 3A voltage regulator ideal for powering core voltages of low-power microprocessors. The MIC47300 implements a dual supply configuration allowing for very low output impedance and very fast transient response.

The MIC47300 requires a bias input supply between 3V and 6.5V for proper operation. The main input supply rail operates from 1.4V to 6.5V that allows for adjustable output voltages down to 0.9V.

The MIC47300 requires a minimum of 1 $\mu$ F output capacitance for stability, and optimal operation is achieved with small ceramic capacitors.

The MIC47300 is available in a 5-pin power D-Pak package (TO-252) with an operating temperature range of -40°C to +125°C.

Datasheets and support documentation can be found on Micrel's web site at: [www.micrel.com](http://www.micrel.com).

### Features

- Input Voltage Range:
  - $V_{IN}$ : 1.4V to 6.5V
  - $V_{BIAS}$ : 3.0V to 6.5V
- **Stable with 1 $\mu$ F ceramic capacitor**
- $\pm 1\%$  initial tolerance
- Maximum dropout voltage ( $V_{IN}-V_{OUT}$ ) of 400mV over temperature
- **Adjustable output voltage down to 0.9V**
- Ultra fast transient response (Up to 10MHz bandwidth)
- Excellent line and load regulation specifications
- Power D-Pak package (TO-252)
- Thermal shutdown and current-limit protection
- Junction temperature range: -40°C to 125°C

### Applications

- Graphics processors
- PC add-in cards
- Microprocessor core voltage supply
- Low voltage digital ICs
- High efficiency linear power supplies
- SMPS post regulators

### Typical Application\*

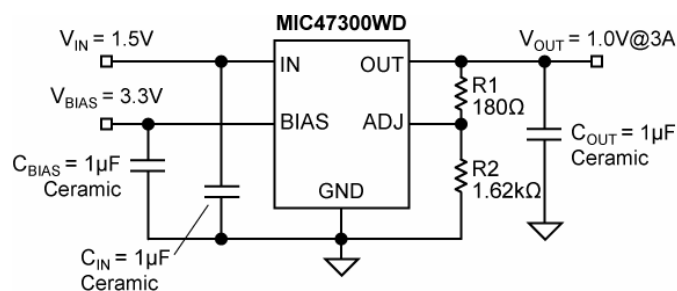

Figure 1. Typical Application Circuit

\*See Thermal Design Section

## Ordering Information

Part Number	Output Current	Voltage	Junction Temp. Range	Package
MIC47300WD*	3A	Adjustable	-40° to +125°C	5-Pin TO-252

**Note:**

\* RoHs compliant with 'high-melting solder' exemption.

## Pin Configuration

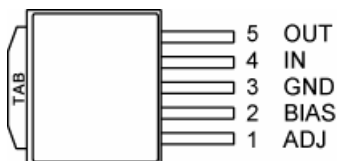

5-Pin TO-252 D-Pak (D)

## Pin Description

Pin Number	Pin Name	Pin Name
1	ADJ	Adjustable Regulator Feedback Input: Connect to the resistor voltage divider that is placed from OUT to GND in order to set the output voltage.
2	BIAS	Input Bias Voltage: Voltage for powering all internal circuitry of the regulator with the exception of the output power device.
3	GND, TAB	Ground: TAB is also connected internally to the IC's ground on D-Pak.
4	IN	Input Voltage: Supplies the current to the output power device
5	OUT	Regulator Output: The output voltage is set by the resistor divider connected from OUT to GND (with the divided connection tied to ADJ). A minimum value capacitor must be used to maintain stability. See Applications Information.

**Absolute Maximum Ratings<sup>(1)</sup>**

Supply Voltage ( $V_{IN}$ )	8V
Bias Supply Voltage ( $V_{BIAS}$ )	8V
Power Dissipation	Internally Limited
ESD Rating <sup>(3)</sup>	2kV

**Operating Ratings<sup>(2)</sup>**

Supply Voltage ( $V_{IN}$ )	1.4V to 6.5V
Bias Supply Voltage ( $V_{BIAS}$ )	3V to 6.5V
Junction Temperature ( $T_J$ )	$-40^{\circ}\text{C} \leq T_J \leq +125^{\circ}\text{C}$
Maximum Power Dissipation	<b>Note 4</b>
Package Thermal Resistance	
TO-252 ( $\theta_{JC}$ )	3°C/W
TO-252 ( $\theta_{JA}$ )	56°C/W

**Electrical Characteristics<sup>(5)</sup>**

$V_{IN} = V_{OUT} + 1\text{V}$ ,  $V_{BIAS} = V_{OUT} + 2.1\text{V}$ ,  $I_{OUT} = 10\text{mA}$ ;  $T_A = 25^{\circ}\text{C}$ , bold values indicate  $-40^{\circ}\text{C} \leq T_J \leq +125^{\circ}\text{C}$ , unless noted.

Symbol	Parameter	Condition	Min	Typ	Max	Units
$V_{LNREG}$	Line Regulation	$V_{IN} = V_{OUT} + 1\text{V}$ to 6.5V	-0.1	0.01	<b>+0.1</b>	%/V
$V_{LDREG}$	Load Regulation	$I_{OUT} = 10\text{mA}$ to A		0.2	<b>0.5</b>	%
$V_{DO}$	Dropout Voltage ( $V_{IN} - V_{OUT}$ )	$I_{OUT} = 1.5\text{A}$ $I_{OUT} = 3\text{A}$		105 230	<b>200</b> <b>400</b>	mV mV
$V_{DO(BIAS)}$	Dropout Voltage ( $V_{BIAS} - V_{OUT}$ ) <b>Note 6</b>	$I_{OUT} = 3\text{A}$		1.24	<b>2.1</b>	V
$I_{GND}$	Ground Pin Current, <b>Note 7</b>	$I_{OUT} = 10\text{mA}$ $I_{OUT} = 3\text{A}$		25 25	<b>50</b>	mA mA
$I_{BIAS}$	Current thru $V_{BIAS}$	$I_{OUT} = 10\text{mA}$ $I_{OUT} = 3\text{A}$		20 50	<b>35</b> <b>150</b>	mA mA
$I_{LIM}$	Current Limit	$V_{OUT} = 0\text{V}$		6.5	<b>10</b>	A
$T_{SD}$	Thermal Shutdown			168		$^{\circ}\text{C}$
	Thermal Shutdown Hysteresis			10		$^{\circ}\text{C}$

**Reference (Adjust Pin)**

$V_{ADJ}$	Reference Voltage		0.891 <b>0.882</b>	0.9	0.909 <b>0.918</b>	V V
$I_{ADJ}$	Adjust Pin Current	$V_{ADJ} = 1.2\text{V}$		0.01	<b>1</b>	$\mu\text{A}$

**Notes:**

- Exceeding the absolute maximum rating may damage the device.
- The device is not guaranteed to function outside its operating rating.
- Devices are ESD sensitive. Handling precautions recommended. Human body model, 1.5k $\Omega$  in series with 100pF.
- $P_{D(MAX)} = (T_{J(MAX)} - T_A) / \theta_{JA}$ , where  $\theta_{JA}$ , depends upon the printed circuit layout. See "Applications Information."
- Specification for packaged product only.
- For  $V_{OUT} \leq 1\text{V}$ ,  $V_{BIAS}$  dropout specification does not apply due to a minimum 3V  $V_{BIAS}$  input.
- $I_{GND} = I_{BIAS} + (I_{IN} - I_{OUT})$ . At high loads, input current on  $V_{IN}$  will be less than the output current, due to drive current being supplied by  $V_{BIAS}$ .

# Typical Characteristics

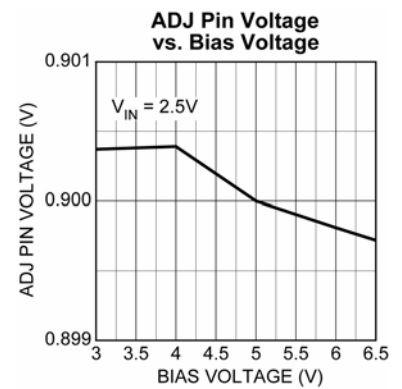
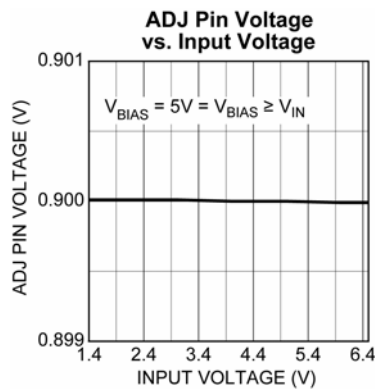
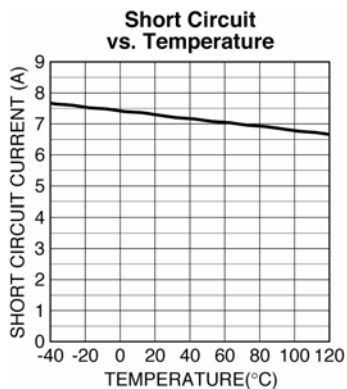
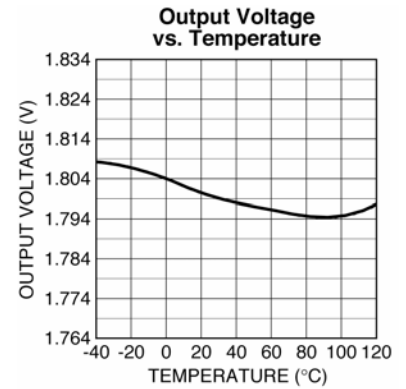
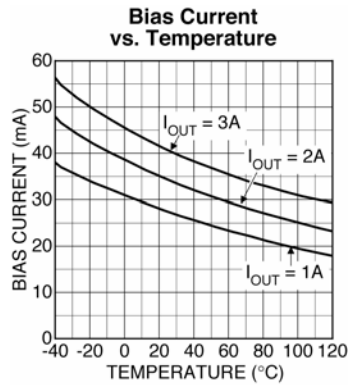
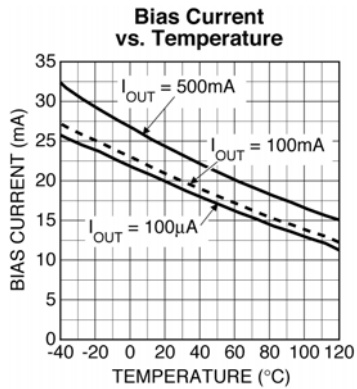
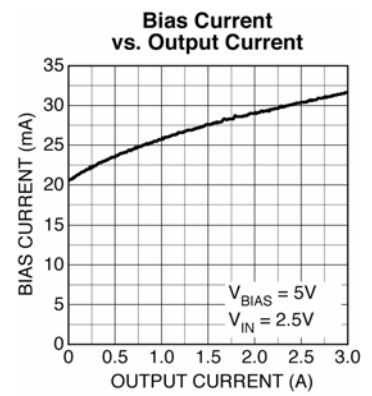
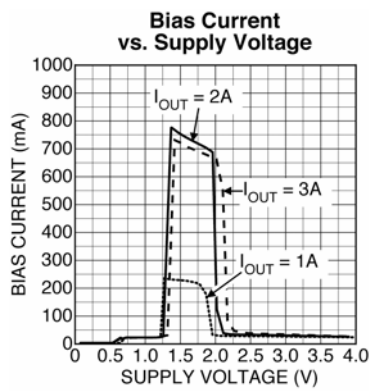
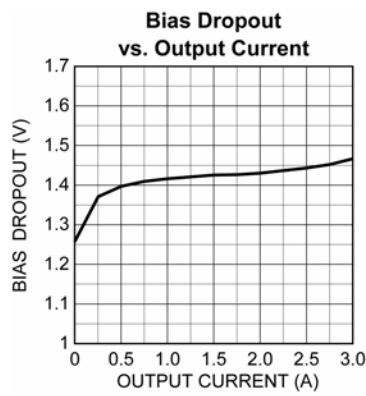
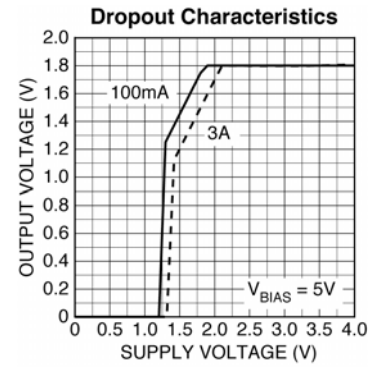
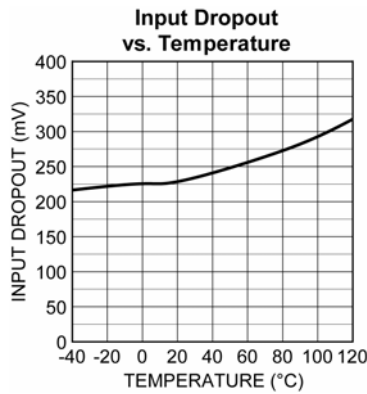
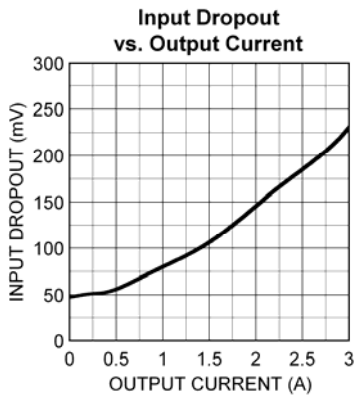

### Typical Characteristics (continued)

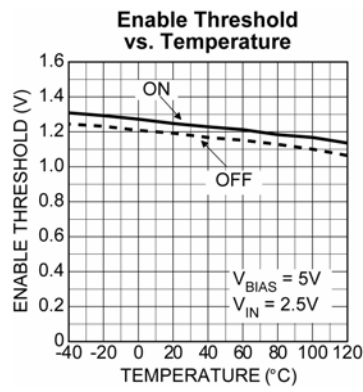
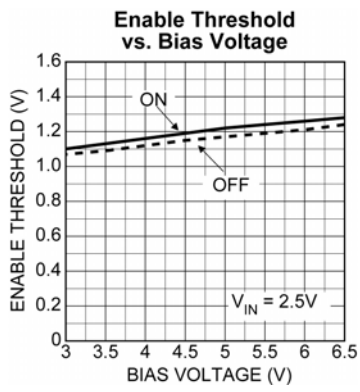

### Functional Characteristics

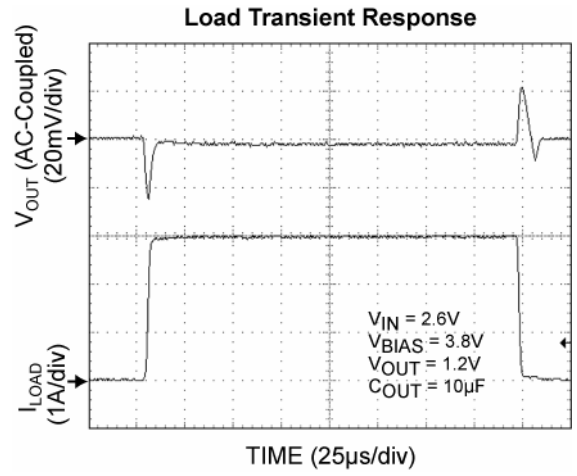
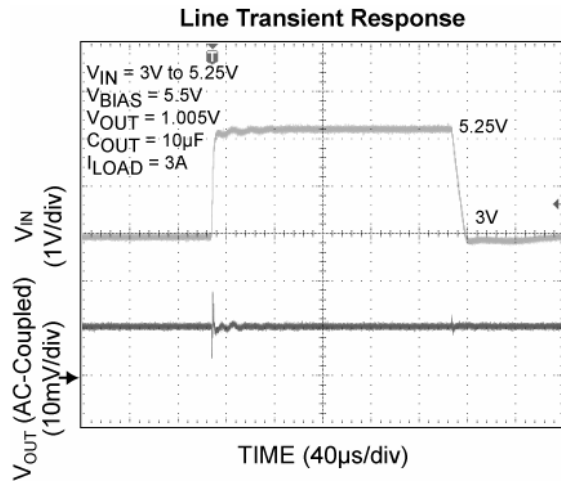

## Functional Description

The MIC47300 is an ultra-high performance, low-dropout linear regulator designed for high current applications requiring fast transient response. The MIC47300 utilizes two input supplies, significantly reducing dropout voltage, perfect for low-voltage, DC-to-DC conversion. The MIC47300 requires a minimum of external components and obtains a bandwidth of up to 10MHz. As a  $\mu$ Cap regulator, the output is tolerant of virtually any type of capacitor including ceramic type and tantalum type capacitors.

The MIC47300 regulator is fully protected from damage due to fault conditions, offering linear current limiting and thermal shutdown.

### Bias Supply Voltage

$V_{BIAS}$ , requiring relatively light current, provides power to the control portion of the MIC47300.  $V_{BIAS}$  requires approximately 50mA for a 3A load current. Dropout conditions require higher currents. Most of the biasing current is used to supply the base current to the pass transistor. This allows the pass element to be driven into saturation, reducing the dropout to 230mV at a 3A load current. Bypassing on the bias pin is recommended to improve performance of the regulator during line and load transients. Small ceramic capacitors from  $V_{BIAS}$  to ground help reduce high frequency noise from being injected into the control circuitry from the bias rail and are good design practice. Good bypass techniques typically include one larger capacitor such as 1 $\mu$ F ceramic and smaller valued capacitors such as 0.01 $\mu$ F or 0.001 $\mu$ F in parallel with that larger capacitor to decouple the bias supply. The  $V_{BIAS}$  input voltage must be 2.1V above the output voltage with a minimum  $V_{BIAS}$  input voltage of 3 volts.

### Input Supply Voltage

$V_{IN}$  provides the high current to the collector of the pass transistor. The minimum input voltage is 1.4V, allowing conversion from low voltage supplies.

### Output Capacitor

The MIC47300 is designed to be stable with a minimal capacitance value and without ESR constraints. However, proper capacitor selection is important to ensure desired transient response. A 1 $\mu$ F ceramic chip capacitor should satisfy most applications and output capacitance can be increased without bound. See “*Typical Characteristic*” for examples of load transient response.

X7R dielectric ceramic capacitors are recommended because of their temperature performance. X7R-type capacitors change capacitance by 15% over their operating temperature range and are the most stable type of ceramic capacitors. Z5U and Y5V dielectric

capacitors change value by as much as 50% and 60% respectively over their operating temperature ranges. To use a ceramic chip capacitor with Y5V dielectric, the value must be much higher than an X7R ceramic or a tantalum capacitor to ensure the same capacitance value over the operating temperature range. Tantalum capacitors have a very stable dielectric (10% over their operating temperature range) and can also be used with this device.

### Input Capacitor

Additional bypass capacitance is recommended when the device is more than 2 to 3 inches away from the bulk supply capacitance, or when the supply is a battery. Small, surface-mount, ceramic chip capacitors can be used for the bypassing. A 1 $\mu$ F or greater ceramic input capacitor should be placed next to the device for optimal performance. Larger values will help to improve ripple rejection by bypassing the input to the regulator, further improving the integrity of the output voltage.

### Thermal Design

Linear regulators are simple to use. The most complicated design parameters to consider are thermal characteristics. Thermal design requires the following application-specific parameters:

- Maximum ambient temperature ( $T_A$ )
- Output current ( $I_{OUT}$ )
- Output voltage ( $V_{OUT}$ )
- Input voltage ( $V_{IN}$ )
- Ground current ( $I_{GND}$ )

First, calculate the power dissipation of the regulator from these numbers and the device parameters from this datasheet.

$$P_D = V_{IN} \times I_{IN} + V_{BIAS} \times I_{BIAS} - V_{OUT} \times I_{OUT}$$

The input current will be less than the output current at high output currents as the load increases. The bias current is a sum of base drive and ground current. Ground current is constant over load current. Then the heat sink thermal resistance is determined with this formula:

$$\theta_{SA} = \left( \frac{T_{J(MAX)} - T_A}{P_D} \right) - (\theta_{JC} + \theta_{CS})$$

The heat sink may be significantly reduced in applications where the maximum input voltage is known and large compared with the dropout voltage. Use a series input resistor to drop excessive voltage and distribute the heat between this resistor and the regulator. The low-dropout properties of the MIC47300 allow significant reductions in regulator power dissipation and the associated heat sink without compromising performance. When this technique is employed, a

capacitor of at least 1 $\mu$ F is needed directly between the input and regulator ground. Refer to “*Application Note 9*” for further details and examples on thermal design and heat sink specification.

The maximum power allowed can be calculated using the thermal resistance ( $\theta_{JA}$ ) of the D-Pak adhering to the following criteria for the PCB design: 2 oz. copper and 100mm<sup>2</sup> copper area for the MIC47300. Given a maximum ambient temperature ( $T_A=75^\circ\text{C}$ ), and without the use of a heat sink, the maximum power allowed that

would not exceed the IC's maximum junction temperature (125°C) is

$$P_{D(\text{MAX})} = (T_{J(\text{MAX})} - T_A) / \theta_{JA} = (125^\circ\text{C} - 75^\circ\text{C}) / (56^\circ\text{C/W}) \\ = 0.893\text{W}$$

#### **Minimum Load Current**

The MIC47300, unlike most other high current regulators, does not require a minimum load to maintain output voltage regulation.



## Application Information

### Adjustable Regulator Design

The MIC47300 allows programming the output down to 0.9V. From the typical application in Figure 1, the output voltage is set by placing a resistor divider network from OUT to GND and is determined by the following equation:

$$V_{OUT} = 0.9 \times \left( \frac{R1}{R2} + 1 \right)$$

where  $V_{OUT}$  is the desired output voltage.

The resistor value between  $V_{OUT}$  and the adjust pin should not exceed 10kΩ. Larger values can cause instability. The resistor values are calculated from the above equation, resulting in the following:

$$R1 = R2 \times \left( \frac{V_{OUT}}{0.9} - 1 \right)$$

### Evaluation Board Layout

The MIC47300 evaluation board layout is shown in Figures 2 and 3. For customer application boards, recommended variations include using a static resistor for R2 in place of the potentiometer as well as the elimination of all test points and jumper options that are included on the MIC47300 evaluation board.

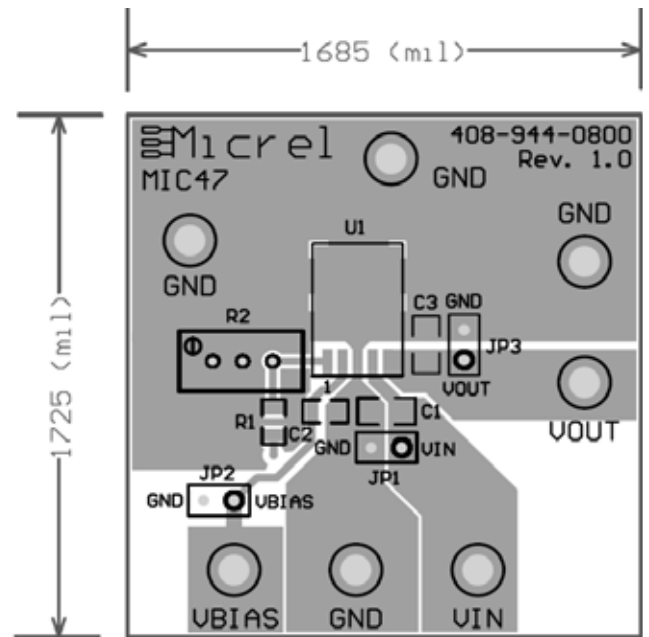

Figure 2. MIC47300 EVB Top Layer

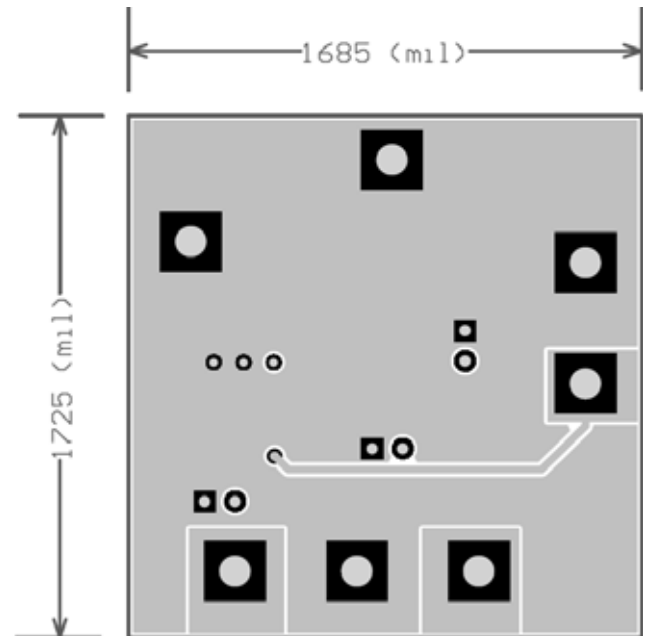
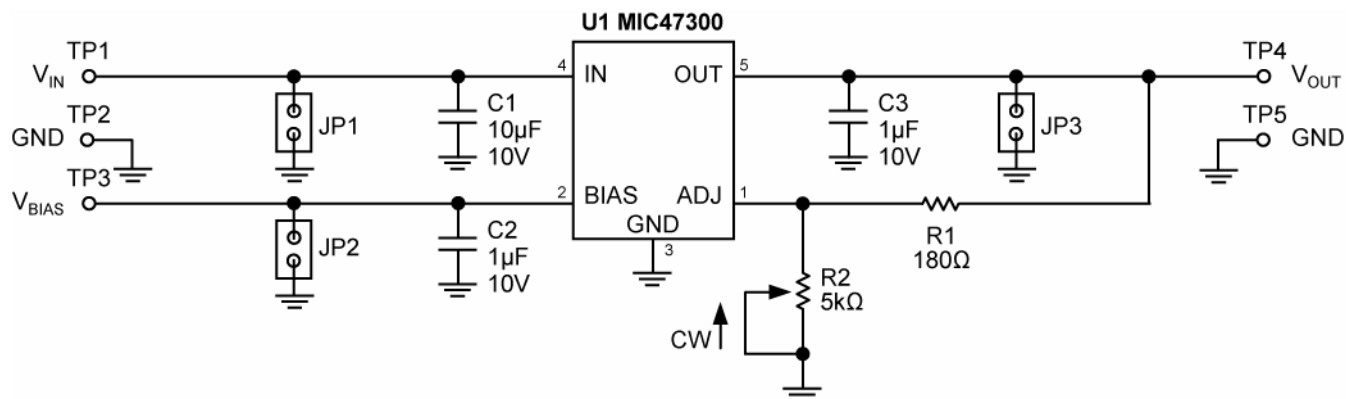

Figure 3. MIC47300 EVB Bottom Layer

## Evaluation Board



## Bill of Materials

Item	Part Number	Manufacturer	Description	Qty.
C1	C1206C106K8RACTU	Kemet <sup>(1)</sup>	10µF, 10V, X7R Ceramic Capacitor	1
C2	C0805C105K8RACTU	Kemet	1µF, 10V, X7R Ceramic Capacitor	1
C3	C0805C105K8RACTU	Kemet	1µF, 10V, X7R Ceramic Capacitor	1
R1	CRCW08051800F	Vishay <sup>(2)</sup>	180Ω Resistor, Film, 0805	1
R2	PV36W502C01B00	Murata <sup>(3)</sup>	5kΩ Potentiometer	1
<b>U1</b>	<b>MIC47300WD</b>	<b>Micrel, Inc.<sup>(4)</sup></b>	<b>MIC47300 LDO Regulator</b>	<b>1</b>

### Notes:

1. Kemet: [www.kemet.com](http://www.kemet.com)
2. Vishay: [www.vishay.com](http://www.vishay.com)
3. Murata: [www.murata.com](http://www.murata.com)
4. Micrel, Inc.: [www.micrel.com](http://www.micrel.com)

**Package Information**

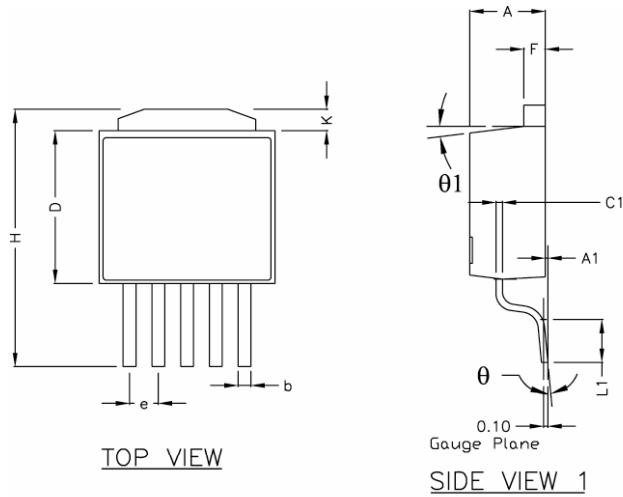

POS	INCH		MM	
	MIN	MAX	MIN	MAX
A	0.087	0.094	2.210	2.387
A1	0.000	0.012	0.000	0.305
b	0.023	0.026	0.584	0.660
C1	0.012	0.023	0.305	0.584
D	0.236	0.241	6.000	6.200
E	0.252	0.260	6.400	6.604
e	0.045	0.055	1.143	1.397
F	0.019	0.023	0.483	0.584
H	0.378	0.402	9.601	10.210
K	0.039	0.047	1.000	1.200
L1	0.055	0.065	1.397	1.651
theta	0°	8°	0°	8°
theta1	3°	10°	3°	10°
Q	0.055	0.075	1.397	1.905
U	0.206	Ref.	5.232	Ref.
V	0.213	Ref.	5.415	Ref.

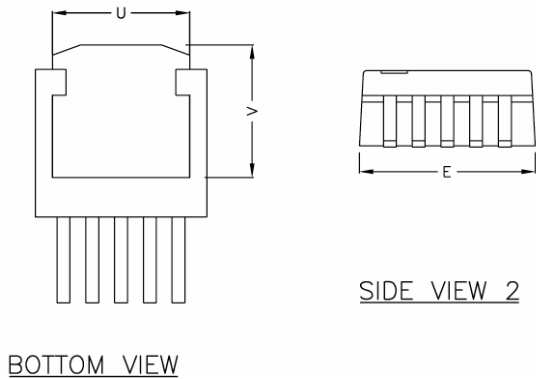

NOTE:  
 1. PACKAGE OUTLINE EXCLUSIVE OF MOLD FLASH & METAL BURR.  
 2. PACKAGE OUTLINE INCLUSIVE OF PLATING THICKNESS.  
 3. FOOT LENGTH USING GAUGE PLANE METHOD MEASUREMENT 0.010"  
 4. ALL DIMENSIONS ARE IN INCHES/MILLIMETERS.

**5-Pin TO-252 Power D-Pak (D)**

**MICREL, INC. 2180 FORTUNE DRIVE SAN JOSE, CA 95131 USA**  
 TEL +1 (408) 944-0800 FAX +1 (408) 474-1000 WEB <http://www.micrel.com>

The information furnished by Micrel in this data sheet is believed to be accurate and reliable. However, no responsibility is assumed by Micrel for its use. Micrel reserves the right to change circuitry and specifications at any time without notification to the customer.

Micrel Products are not designed or authorized for use as components in life support appliances, devices or systems where malfunction of a product can reasonably be expected to result in personal injury. Life support devices or systems are devices or systems that (a) are intended for surgical implant into the body or (b) support or sustain life, and whose failure to perform can be reasonably expected to result in a significant injury to the user. A Purchaser's use or sale of Micrel Products for use in life support appliances, devices or systems is a Purchaser's own risk and Purchaser agrees to fully indemnify Micrel for any damages resulting from such use or sale.

© 2009 Micrel, Incorporated.