

# AS series

## Snap-in rocker switches

*Distinctive features and specifications*

- Double insulation
- Epoxy sealed terminals
- UL and CSA approved

### ELECTRICAL AND GENERAL SPECIFICATIONS

- Max. current/voltage rating with resistive load :
  - silver contacts (code 1) and gold plated silver contacts (code 2) : 2A 250VAC - 4A 125VAC
  - gold plated brass contacts (code 0) : 0,4VA 20V AC or DC
- Initial contact resistance : 10 mΩ max.
- Insulation resistance : 10.000 MΩ min.
- Dielectric strength :
  - 1.000 Vrms 50 Hz min. between terminals
  - 4.000 Vrms 50 Hz min. between terminals and metal panel
- Electrical life : 50.000 cycles
- Operating temperature : -40°C to +85°C

### MATERIALS

- Case : PES
- Actuator : polyamide
- Contacts
  - 0 : brass, gold plated
  - 1 : silver
  - 2 : silver, gold plated
  - 5 : special contact, lower rating
- Minimum quantity : consult factory.
- Terminal seal : epoxy

### APPROVALS



**Availability** : consult factory for details or approved models.

**Marking** : to order switches marked with above approvals, complete last box of ordering format.

### ABOUT THIS SERIES

**Dimensions** : first dimensions are in mm while inches are shown as bracketted numbers.



**Packaging unit** : 50 pieces.



# AS series

## Snap-in rocker switches

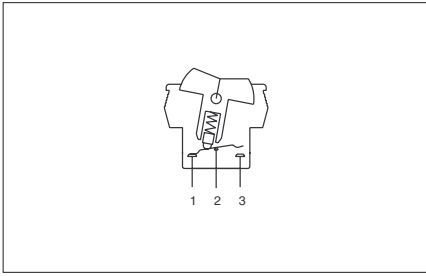

- Black body
- Single pole configuration

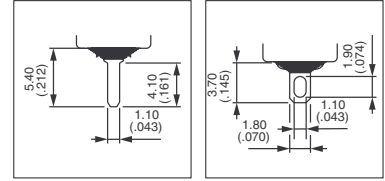

### MODEL STRUCTURE

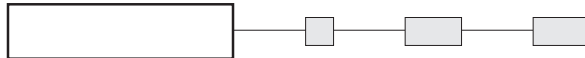

### Solder lug terminals



AS36SO  
AS39SO  
AS37SO  
AS38SO  
AS32SO

III	II	I
ON	-	ON
ON	OFF	ON
MOM	OFF	MOM
ON	OFF	MOM
ON	-	MOM

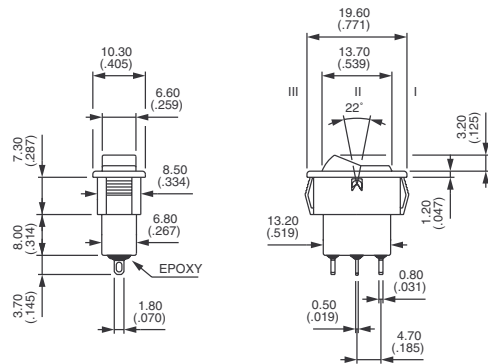

### Straight PC terminals



AS36PO  
AS39PO  
AS37PO  
AS38PO  
AS32PO

III	II	I
ON	-	ON
ON	OFF	ON
MOM	OFF	MOM
ON	OFF	MOM
ON	-	MOM

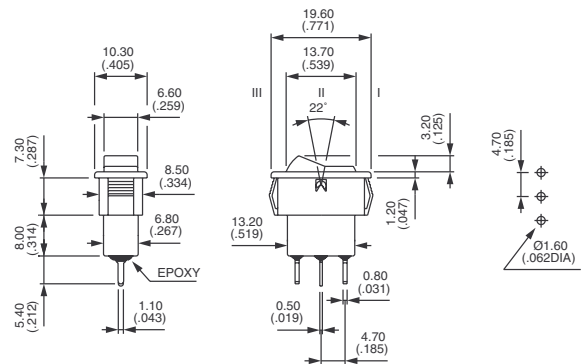

### PANEL CUT-OUT

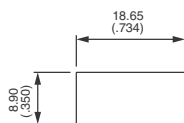

# AS series

## Snap-in rocker switches



### CONTACT MATERIALS

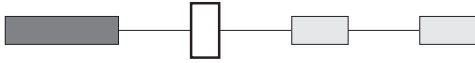

- 0 Brass, gold plated
- 1 Silver
- 2 Silver, gold plated
- 5 Special contact, lower rating  
Minimum quantity. Consult factory

### ACTUATORS

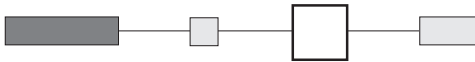

- 00 Black
- 01 Red
- 02 Grey
- 03 Blue
- 04 Ivory
- 07 White
- 09 Dark blue

For marking on actuator, consult factory.

### OTHER OPTIONS



- 10 With **UL-CSA** marking
- 20 10 mm (.393) long straight PC terminals

