

CAT4002B, CAT4003B, CAT4004B

Constant Current Programmable LED Driver with 32 Dimming Levels

Description

The CAT4002B, CAT4003B and CAT4004B provide respectively two, three and four matched low dropout current sources to drive LEDs. The CAT400XB requires no external RSET resistor; the LED current is internally set to 25 mA when the device is first enabled. Each LED channel includes an individual control loop allowing the device to handle a wide range of LED forward voltages while still maintaining tight current matching.

The EN/DIM logic input supports the device enable and a digital dimming interface for setting the LED channel current with 32 linear dimming levels.

LEDs can be powered directly from a Lithium-ion battery due to the low dropout (75 mV at 20 mA) current sinks.

Package options are available including the 4-channel tiny 8-pad UDFN 2 mm x 2 mm with a max height of 0.55 mm, and 2 or 3-channel in the 6-lead TSOT-23 and SC-70.

Features

- 2, 3, 4 LED Current Sinks with Tight Matching
- 32 Dimming Levels
- Low Dropout Driver 75 mV at 20 mA
- No Switching Noise
- Shutdown Current less than 1 μ A
- 25 mA Max LED Current per Channel
- Dimming via 1-wire EZDim™ Interface
- Thermal Shutdown Protection
- RoHS Compliant
- 6-lead TSOT-23, SC-70, and 8-pad UDFN 2 mm x 2 mm Packages

Typical Applications

- LCD Display Backlight
- Cellular Phones
- Digital Still Cameras



ON Semiconductor®

<http://onsemi.com>



UDFN-8
HU2 SUFFIX
CASE 517AW

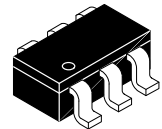

TSOT23-6
TD SUFFIX
CASE 419AF

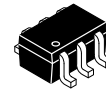

SC70-6
SD SUFFIX
CASE 419AD

TYPICAL APPLICATION CIRCUIT

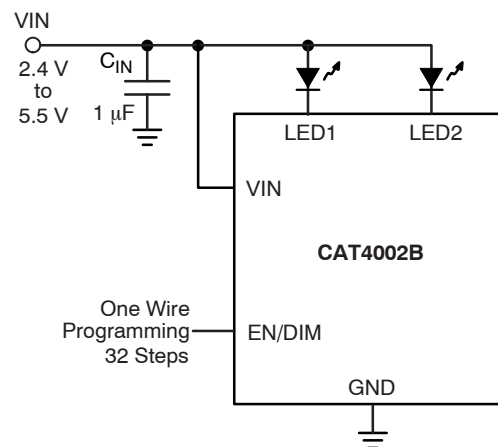

ORDERING INFORMATION

See detailed ordering information on page 2 of this data sheet.

CAT4002B, CAT4003B, CAT4004B

MARKING DIAGRAMS

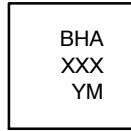

UDFN8 (2 x 2 mm)

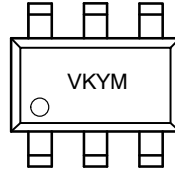

TSOT23-6L

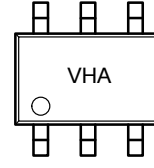

SC70-6L

BH = CAT4004B Device Code
 A = Assembly Location Code
 XXX = Last Three Digits of Assembly Lot Number
 Y = Production Year (last digit)
 M = Production Month: 1 - 9, A, B, C

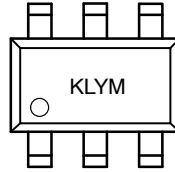

TSOT23-6L

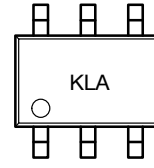

SC70-6L

VK = CAT4002B Device Code
 KL = CAT4003B Device Code
 Y = Production Year (last digit)
 M = Production Month: 1 - 9, A, B, C

VH = CAT4002B Device Code
 KL = CAT4003B Device Code
 A = Assembly Location Code

ORDERING INFORMATION (Note 1)

Orderable Part Number	Package	Finish	Shipping (Note 2)
CAT4002BTD-GT3	TSOT-23, 6-Lead	NiPdAu (RoHS Compliant)	3,000 / Tape & Reel
CAT4002BSD-GT3	SC-70, 6-Lead	NiPdAu (RoHS Compliant)	3,000 / Tape & Reel
CAT4003BTD-GT3	TSOT-23, 6-Lead	NiPdAu (RoHS Compliant)	3,000 / Tape & Reel
CAT4003BSD-GT3	SC-70, 6-Lead	NiPdAu (RoHS Compliant)	3,000 / Tape & Reel
CAT4004BHU2-GT3	UDFN, 8-Pad, 2 x 2 mm	NiPdAu (RoHS Compliant)	3,000 / Tape & Reel

- For additional package and temperature options, please contact your nearest ON Semiconductor Sales office.
- For information on tape and reel specifications, including part orientation and tape sizes, please refer to our Tape and Reel Packaging Specifications Brochure, BRD8011/D.

CAT4002B, CAT4003B, CAT4004B

PIN CONNECTIONS (Top View)

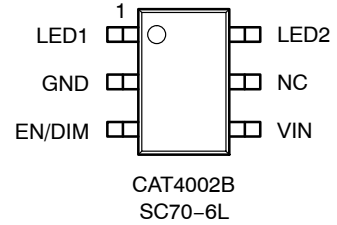
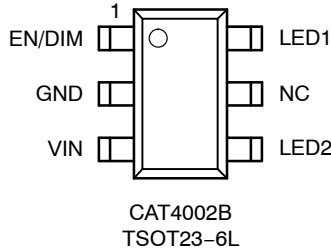
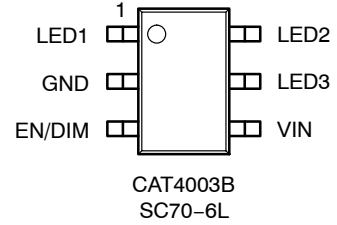
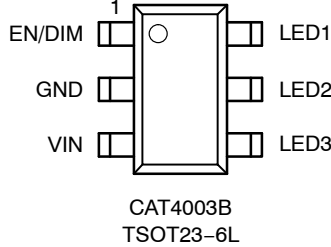
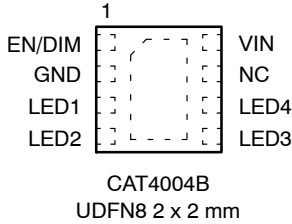

Table 1. PIN FUNCTIONS

Pin Name	Function
EN/DIM	Device Enable (active high) and Dimming Control
GND	Ground Reference
LED1	LED1 Cathode Terminal
LED2	LED2 Cathode Terminal
LED3	LED3 Cathode Terminal
LED4	LED4 Cathode Terminal
VIN	Device Supply Input, Connect to Battery or Supply
TAB	Connect to GND on the PCB

Table 2. ABSOLUTE MAXIMUM RATINGS

Parameter	Value	Unit
VIN, LEDx Voltage	6	V
EN/DIM Voltage	VIN + 0.7	V
Storage Temperature Range	-65 to +160	°C
Junction Temperature Range	-40 to +125	°C
Lead Temperature	300	°C

Stresses exceeding Maximum Ratings may damage the device. Maximum Ratings are stress ratings only. Functional operation above the Recommended Operating Conditions is not implied. Extended exposure to stresses above the Recommended Operating Conditions may affect device reliability.

Table 3. RECOMMENDED OPERATING CONDITIONS

Parameter	Value	Unit
VIN	2.4 to 5.5	V
Ambient Temperature Range	-40 to +85	°C
LED Current Range	0 to 25	mA

3. Typical application circuit with external components is shown on page 1.

CAT4002B, CAT4003B, CAT4004B

Table 4. ELECTRICAL OPERATING CHARACTERISTICS

(over recommended operating conditions unless specified otherwise) ($V_{IN} = 4.0\text{ V}$, $EN = \text{High}$, $T_{AMB} = 25^\circ\text{C}$)

Parameter	Conditions	Symbol	Min	Typ	Max	Units
Quiescent Current	$I_{LED} = 25\text{ mA/channel}$	I_Q	0.5	0.7	1.5	mA
Shutdown Current	$V_{EN} = 0\text{ V}$	I_{QSHDN}			1	μA
Full Scale LED Current (Average) (Note 4)		$I_{LED-FULL}$	24	25	26	mA
LED Channel Matching	$\frac{I_{LED} - I_{LEDAVG}}{I_{LEDAVG}}$	$I_{LED-DEV}$	-5	± 1	+5	%
Dropout Voltage	$I_{LED} = 20\text{ mA}$ $I_{LED} = 1\text{ mA}$	V_{DOUT}		75 45		mV
EN/DIM Pin – Internal pull-down resistor – Logic High Level – Logic Low Level		$R_{EN/DIM}$ V_{HI} V_{LO}	1.3	100	0.4	k Ω V V
Thermal Shutdown		T_{SD}		150		$^\circ\text{C}$
Thermal Hysteresis		T_{HYS}		20		$^\circ\text{C}$
Undervoltage lockout (UVLO) threshold		V_{UVLO}		2.0		V

- For the CAT4004B, $I_{LEDAVG} = (I_{LED,CH1} + I_{LED,CH2} + I_{LED,CH3} + I_{LED,CH4}) / 4$
For the CAT4003B, $I_{LEDAVG} = (I_{LED,CH1} + I_{LED,CH2} + I_{LED,CH3}) / 3$
For the CAT4002B, $I_{LEDAVG} = (I_{LED,CH1} + I_{LED,CH2}) / 2$
- The standard lead finish is NiPdAu.

Table 5. RECOMMENDED EN/DIM TIMING (For $2.4\text{ V} \leq V_{IN} \leq 5.5\text{ V}$, over full ambient temperature range -40°C to $+85^\circ\text{C}$.)

Parameter	Conditions	Symbol	Min	Typ	Max	Units
EN/DIM program low time		T_{LO}	0.2		100	μs
EN/DIM program high time		T_{HI}	0.2			μs
LED current settling time		T_{LED}		10		μs
EN/DIM low time to shutdown		T_{PWRDWN}	2	3	5	ms

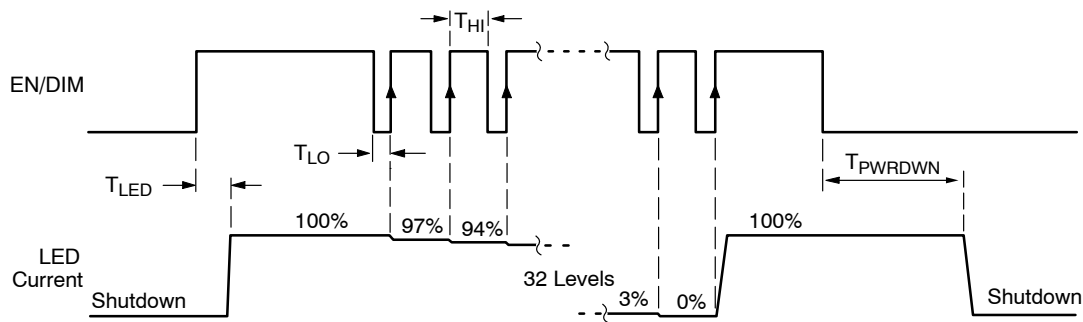

Figure 1. CAT400XB EN/DIM Dimming Timing Diagram

LED Current Setting

On the CAT400XB, the full scale LED current is internally set to 25 mA (no external resistor).

When the EN/DIM is first enabled, the CAT400XB sets the LED channel current to the full scale current. Each

consecutive rising edge on the EN/DIM decreases the LED current by one step until it goes to zero, as shown on Figure 1.

CAT4002B, CAT4003B, CAT4004B

TYPICAL CHARACTERISTICS

(CAT4003B, $V_{IN} = 4\text{ V}$, $V_F = 3.3\text{ V}$, $I_{OUT} = 75\text{ mA}$ (3 LEDs at 25 mA), $C_{IN} = 1\text{ }\mu\text{F}$, $T_{AMB} = 25^\circ\text{C}$ unless otherwise specified.)

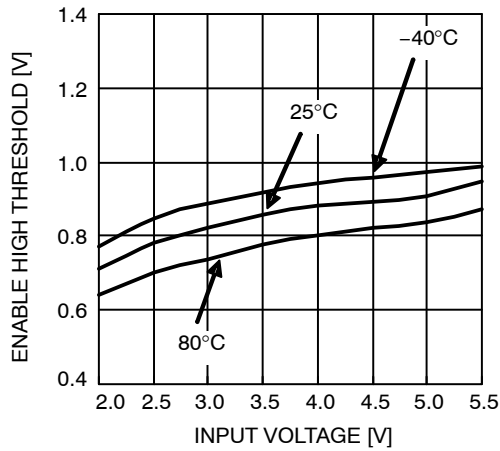

Figure 2. EN High Threshold vs. Input Voltage

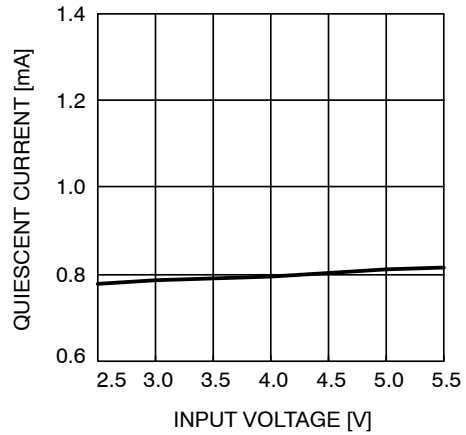

Figure 3. Quiescent Current vs. Input Voltage (full load)

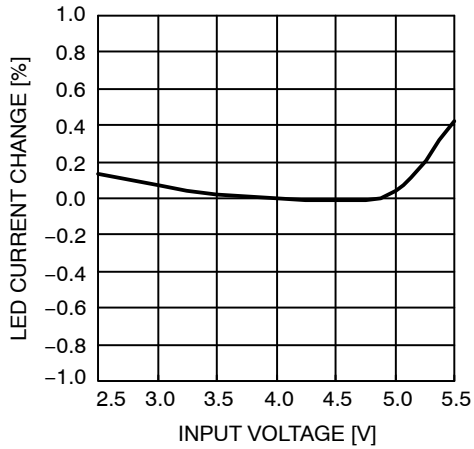

Figure 4. LED Current Change vs. Input Voltage

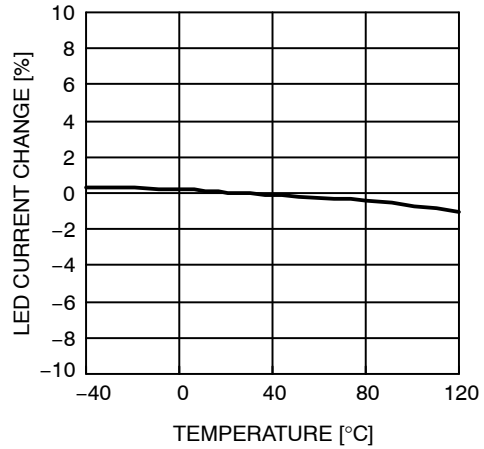

Figure 5. LED Current Change vs. Temperature

CAT4002B, CAT4003B, CAT4004B

TYPICAL CHARACTERISTICS

(CAT4003B, $V_{IN} = 4\text{ V}$, $V_F = 3.3\text{ V}$, $I_{OUT} = 75\text{ mA}$ (3 LEDs at 25 mA), $C_{IN} = 1\text{ }\mu\text{F}$, $T_{AMB} = 25^\circ\text{C}$ unless otherwise specified.)

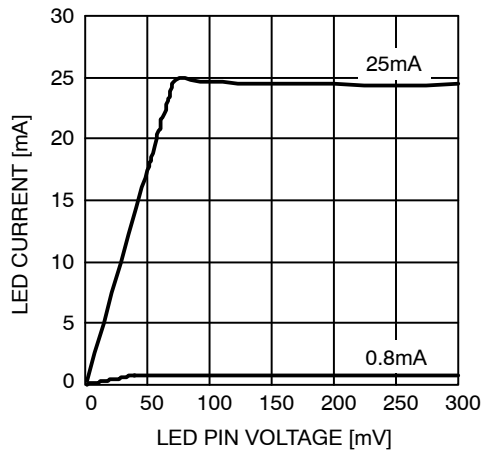

Figure 6. Dropout Characteristics

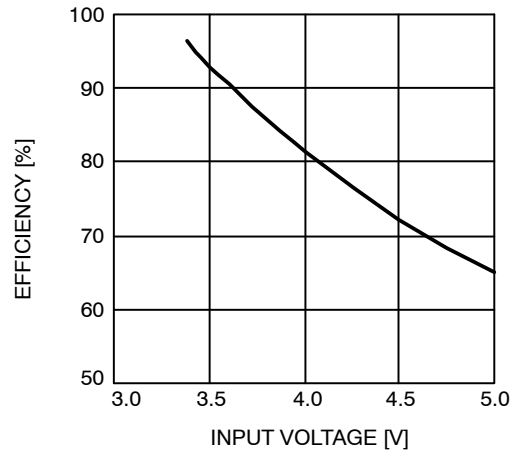

Figure 7. Efficiency vs. Input Voltage

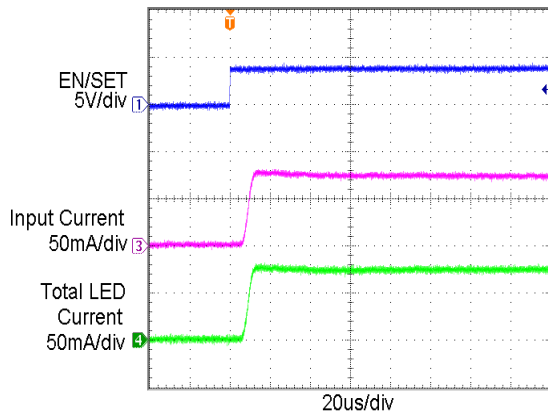

Figure 8. Power Up Waveform

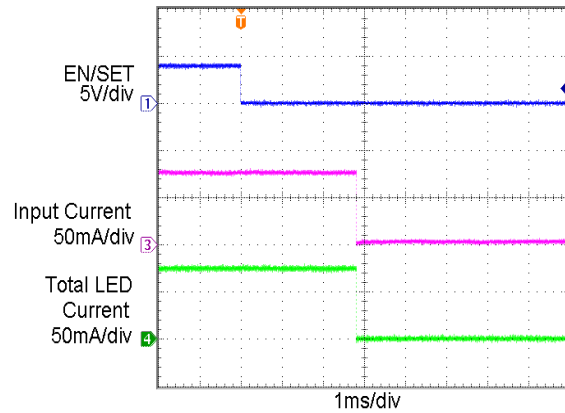

Figure 9. Power Down Waveform

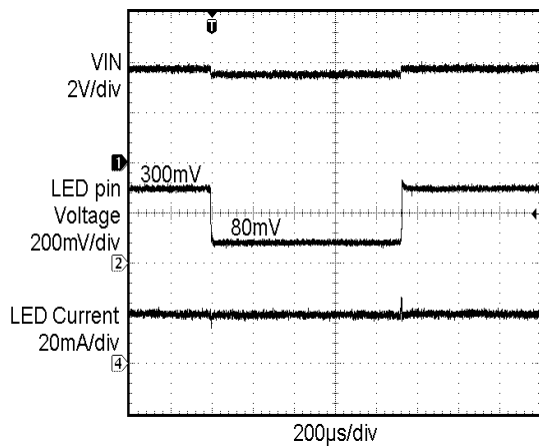

Figure 10. Line Transient Waveform

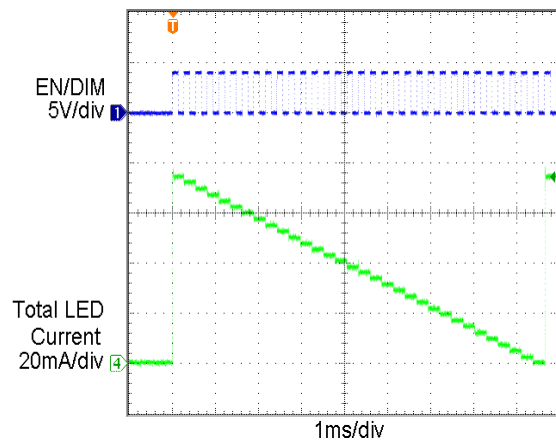

Figure 11. Dimming Levels

CAT4002B, CAT4003B, CAT4004B

Pin Functions

V_{IN} is the supply pin for the charge pump. A small 1 µF ceramic bypass capacitor is required between the V_{IN} pin and ground near the device. The operating input voltage range is from 2.4 V to 5.5 V. Whenever the input supply falls below the under-voltage threshold (2.0 V), all the LED channels are disabled and the device enters shutdown mode.

EN/DIM is the enable and one wire dimming input for all LED channels. Levels of logic high and logic low are set at 1.3 V and 0.4 V respectively. When EN/DIM is initially taken high, the CAT400XB becomes enabled and all LED currents are set to the full scale 25 mA. To place the device

into “zero current” shutdown mode, the EN/DIM pin must be held low for 3 ms typical

LED1 to LED4 provide the internal regulated current for each of the LED cathodes. These pins enter a high impedance zero current state whenever the device is placed in shutdown mode.

GND is the ground reference for the device. The pin must be connected to the ground plane on the PCB.

TAB (CAT4004B only) is the exposed pad underneath the package. For best thermal performance, the tab should be soldered to the PCB and connected to the ground plane.

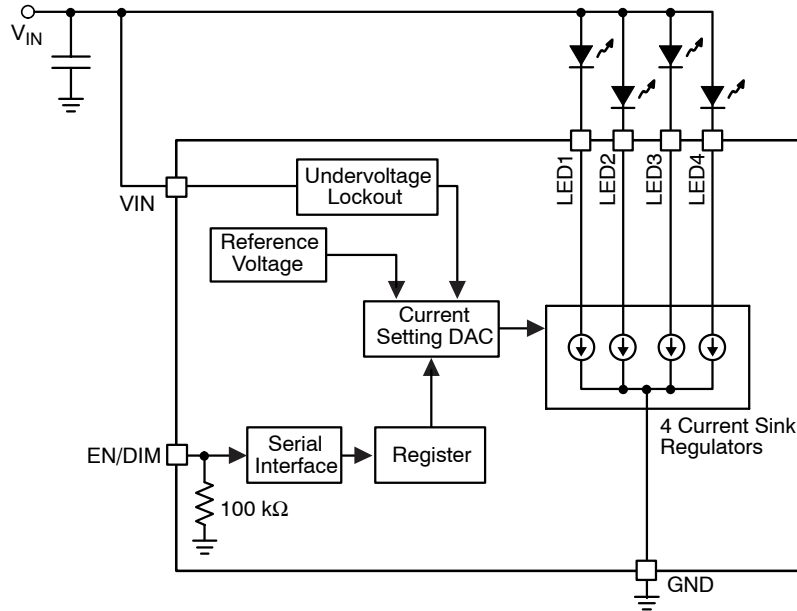

Figure 12. CAT4004B Functional Block Diagram

Basic Operation

The CAT400XB uses tightly matched current sinks to accurately regulate LED current in each channel.

There are 32 different settings for LED brightness that can be programmed through the EN/DIM pin. Tight current regulation for all channels is possible over a wide range of input and LED voltages due to independent current sensing circuitry on each channel.

Each LED channel needs a minimum of 75 mV headroom to sink a constant regulated current of 20 mA. If the input supply falls below 2.0 V, the under-voltage lockout circuit disables all LED channels and resets the circuit to default values. Any unused LED channels should be left open.

CAT400XB LED Current Selection

After power-up and once enabled, the LED current is set initially to the full scale current of 25 mA. The number of pulses (n) on the EN/DIM input does decrease the current value as follows:

$$\text{LED current [mA]} = 25 \times \left(\frac{31 - n}{31} \right)$$

The full scale current is calculated from the above formula with n equal to zero.

The EN/DIM pin has two primary functions. One function enables and disables the device. The other function is LED current dimming with 32 different levels by pulsing the input signal, as shown on Figure 13. On each consecutive pulse rising edge, the LED current is decreased by about 3.2% (1/31th of the full scale value). After 30 pulses, the LED current is 3.2% of the full scale current. On the 31st pulse, the current drops to zero, and then goes back to full scale on the following pulse.

Each pulse width should be between 200 ns and 100 µs. Pulses faster than the minimum TLO may be ignored and filtered by the device. Pulses longer than the maximum TLO may shutdown the device. By pulsing the EN/DIM signal at high frequency, the LED current can quickly be set to zero.

The LED driver enters a “zero current” shutdown mode if EN/DIM is held low for 3 ms typical.

The dimming level is set by the number of pulses on the EN/DIM after the power-up, as shown in Table 6.

CAT4002B, CAT4003B, CAT4004B

Table 6. DIMMING LEVELS

Full Scale Current in %	Dimming Pulses [n]
100	0
97	1
94	2
90	3
87	4
84	5
81	6
77	7
74	8
71	9
68	10
65	11
61	12
58	13
55	14
52	15

Full Scale Current in %	Dimming Pulses [n]
48	16
45	17
42	18
39	19
35	20
32	21
29	22
26	23
23	24
19	25
16	26
13	27
10	28
6	29
3	30
0	31
100	32

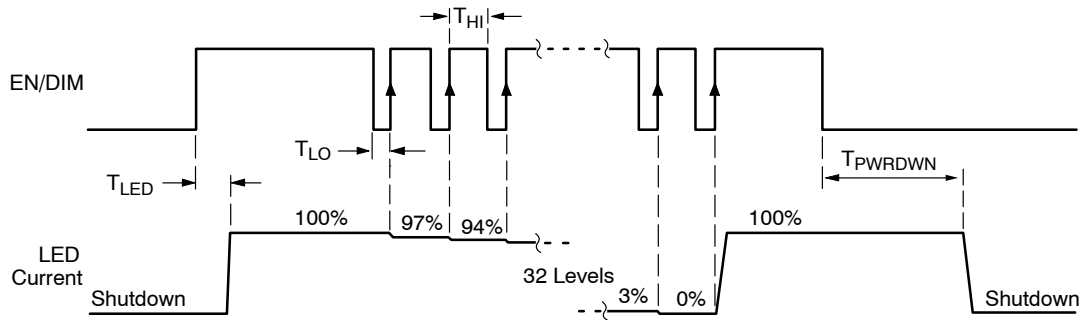
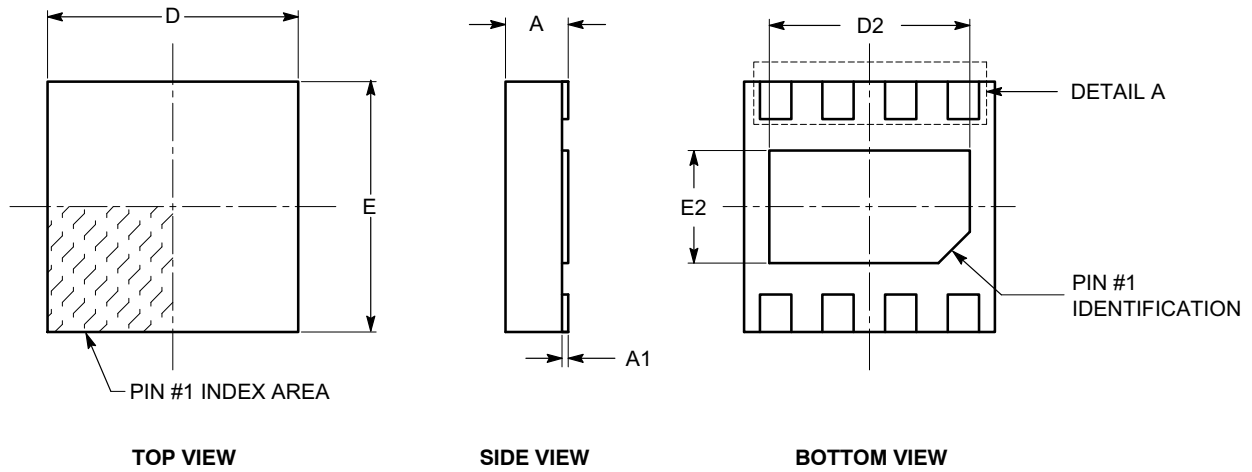

Figure 13. EN/DIM Digital Dimming Timing Diagram

CAT4002B, CAT4003B, CAT4004B

PACKAGE DIMENSIONS

UDFN8, 2x2
CASE 517AW-01
ISSUE O



SYMBOL	MIN	NOM	MAX
A	0.45	0.50	0.55
A1	0.00	0.02	0.05
b	0.18	0.25	0.30
D	1.90	2.00	2.10
D2	1.50	1.60	1.70
E	1.90	2.00	2.10
E2	0.80	0.90	1.00
e	0.50 BSC		
L	0.20	0.30	0.45

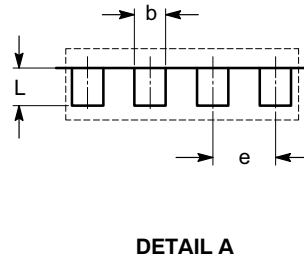

Notes:

- (1) All dimensions are in millimeters.
- (2) Complies with JEDEC MO-229.

CAT4002B, CAT4003B, CAT4004B

PACKAGE DIMENSIONS

SC-70, 6 Lead, 1.25x2
CASE 419AD-01
ISSUE O

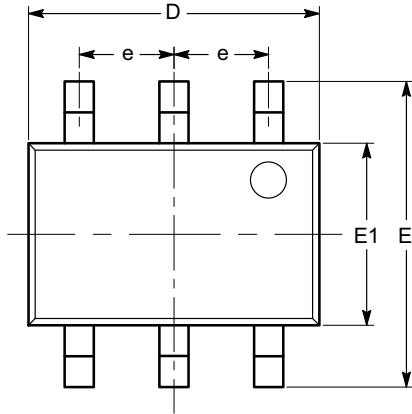

TOP VIEW

SYMBOL	MIN	NOM	MAX
A	0.80		1.10
A1	0.00		0.10
A2	0.80		1.00
b	0.15		0.30
c	0.10		0.18
D	1.80	2.00	2.20
E	1.80	2.10	2.40
E1	1.15	1.25	1.35
e	0.65 BSC		
L	0.26	0.36	0.46
L1	0.42 REF		
L2	0.15 BSC		
θ	0°		8°
θ_1	4°		10°

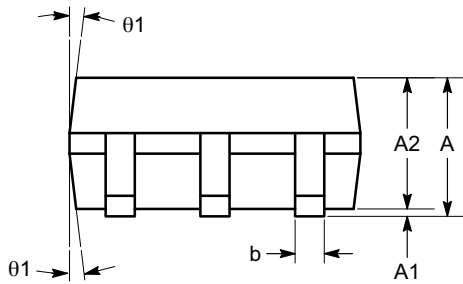

SIDE VIEW

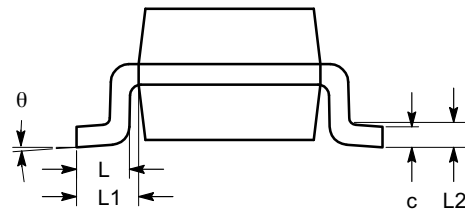

END VIEW

Notes:

- (1) All dimensions are in millimeters. Angles in degrees.
- (2) Complies with JEDEC MO-203.

CAT4002B, CAT4003B, CAT4004B

PACKAGE DIMENSIONS

TSOT-23, 6 LEAD
CASE 419AF-01
ISSUE O

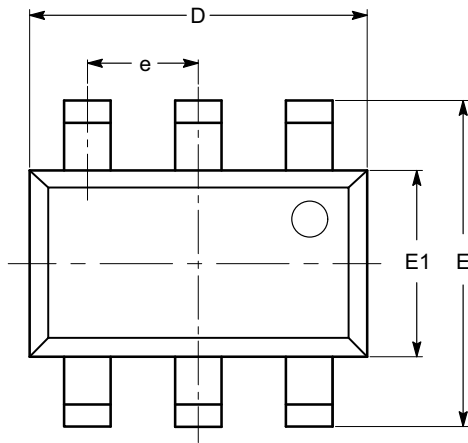

TOP VIEW

SYMBOL	MIN	NOM	MAX
A			1.00
A1	0.01	0.05	0.10
A2	0.80	0.87	0.90
b	0.30		0.45
c	0.12	0.15	0.20
D	2.90 BSC		
E	2.80 BSC		
E1	1.60 BSC		
e	0.95 TYP		
L	0.30	0.40	0.50
L1	0.60 REF		
L2	0.25 BSC		
θ	0°		8°

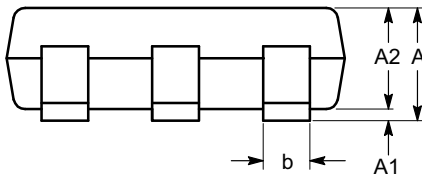

SIDE VIEW

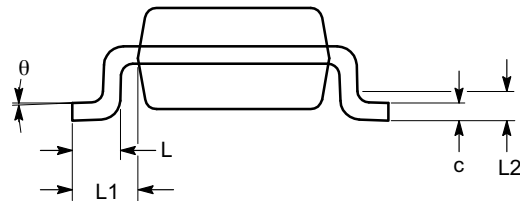

END VIEW

Notes:

- (1) All dimensions are in millimeters. Angles in degrees.
- (2) Complies with JEDEC MO-193.

ON Semiconductor and  are registered trademarks of Semiconductor Components Industries, LLC (SCILLC). SCILLC reserves the right to make changes without further notice to any products herein. SCILLC makes no warranty, representation or guarantee regarding the suitability of its products for any particular purpose, nor does SCILLC assume any liability arising out of the application or use of any product or circuit, and specifically disclaims any and all liability, including without limitation special, consequential or incidental damages. "Typical" parameters which may be provided in SCILLC data sheets and/or specifications can and do vary in different applications and actual performance may vary over time. All operating parameters, including "Typicals" must be validated for each customer application by customer's technical experts. SCILLC does not convey any license under its patent rights nor the rights of others. SCILLC products are not designed, intended, or authorized for use as components in systems intended for surgical implant into the body, or other applications intended to support or sustain life, or for any other application in which the failure of the SCILLC product could create a situation where personal injury or death may occur. Should Buyer purchase or use SCILLC products for any such unintended or unauthorized application, Buyer shall indemnify and hold SCILLC and its officers, employees, subsidiaries, affiliates, and distributors harmless against all claims, costs, damages, and expenses, and reasonable attorney fees arising out of, directly or indirectly, any claim of personal injury or death associated with such unintended or unauthorized use, even if such claim alleges that SCILLC was negligent regarding the design or manufacture of the part. SCILLC is an Equal Opportunity/Affirmative Action Employer. This literature is subject to all applicable copyright laws and is not for resale in any manner.

PUBLICATION ORDERING INFORMATION

LITERATURE FULFILLMENT:

Literature Distribution Center for ON Semiconductor
P.O. Box 5163, Denver, Colorado 80217 USA
Phone: 303-675-2175 or 800-344-3860 Toll Free USA/Canada
Fax: 303-675-2176 or 800-344-3867 Toll Free USA/Canada
Email: orderlit@onsemi.com

N. American Technical Support: 800-282-9855 Toll Free
USA/Canada
Europe, Middle East and Africa Technical Support:
Phone: 421 33 790 2910
Japan Customer Focus Center
Phone: 81-3-5773-3850

ON Semiconductor Website: www.onsemi.com

Order Literature: <http://www.onsemi.com/orderlit>

For additional information, please contact your local Sales Representative

CAT4002B/D