

# LM2773

## Low-Ripple 1.8V/1.6V Spread-Spectrum Switched Capacitor Step-Down Regulator

### General Description

The LM2773 is a switched capacitor step-down regulator that produces a selectable 1.8V or 1.6V output. It is capable of supplying loads up to 300mA. The LM2773 operates with an input voltage from 2.5V to 5.5V, accommodating 1-cell Li-Ion batteries and chargers.

The LM2773 utilizes a regulated charge pump with gains of 2/3x and 1x. It has very low ripple and noise on both the input and output due to its pre-regulated 1.15MHz (typ.) switching frequency and spread spectrum operation. When output currents are low, the LM2773 automatically switches to a low-ripple PFM regulation mode to maintain high efficiency over the entire load range.

The LM2773 is available in National's 0.5mm pitch 9-bump Micro-SMD ( $\mu$ SMD-9).

### Features

- Low-Noise Spread Spectrum Operation
- 1.8V/1.6V Selectable Output Voltage
- 2% Output Voltage Regulation
- > 75% Efficiency in 1.8V Mode
- Very Low Output Ripple: 10mV @ 300mA
- Output Currents up to 300mA
- 2.5V to 5.5V Input Voltage Range
- Shutdown Disconnects Load from  $V_{IN}$
- 1.15MHz Switching Frequency
- No Inductors...Small Solution Size
- Short Circuit and Thermal Protection
- 0.5mm pitch,  $\mu$ SMD-9 (1.511 × 1.511mm × 0.6mm)

### Applications

- Power Supply for DSP's, Memory, and Microprocessors
- Mobile Phones and Pagers
- Digital Cameras, Portable Music Players, and Other Portable Electronic Devices

### Typical Application Circuit

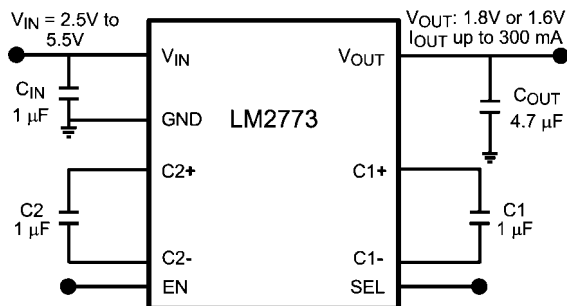

Capacitors: 1  $\mu$ F - C1005 (0402), X5R, 6.3V  
4.7  $\mu$ F - C1608 (0603), X5R, 6.3V  
or equivalent

30047401

LM2773 Efficiency vs. Low-Dropout Linear Regulator (LDO) Efficiency

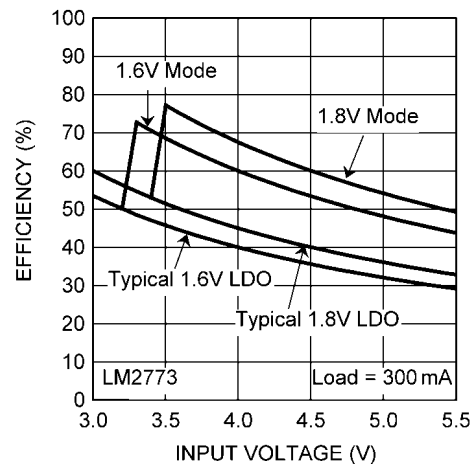

30047410

## Connection Diagram and Package Mark Information

9-Bump Micro SMD ( $\mu$ SMD-9)  
NS Package Number TLA9ZZA, 0.5mm Pitch  
1.511mm x 1.511mm x 0.6mm

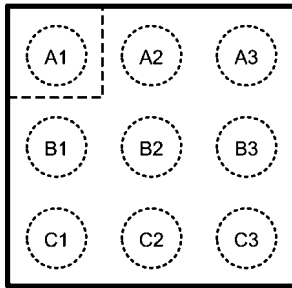

Top View

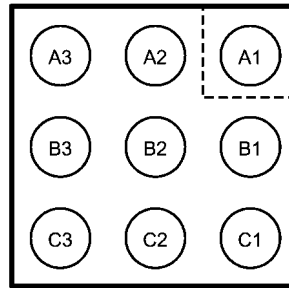

Bottom View

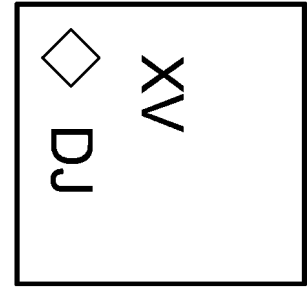

Top Marking

30047402

**Note 1:** The actual physical placement of the package marking will vary from part to part. The package marking "X" designates the single digit date code. "V" is a NSC internal code for die traceability. Both will vary considerably. "DJ" identifies the device (part number, option, etc.).

## Pin Descriptions

Pin #	Name	Description
A1	C2-	Flying Capacitor 2: Negative Terminal
A2	$V_{OUT}$	Output Voltage
A3	C1+	Flying Capacitor 1: Positive Terminal
B1	GND	Ground
B2	EN	Device Enable. Logic HIGH: Enabled, Logic LOW: Shutdown.
B3	$V_{IN}$	Input Voltage. Recommended $V_{IN}$ Operating Range = 2.5V to 5.5V.
C1	SEL	Voltage Mode Select. Logic HIGH: $V_{OUT} = 1.6V$ , Logic LOW: $V_{OUT} = 1.8V$
C2	C1-	Flying Capacitor 1: Negative Terminal
C3	C2+	Flying Capacitor 2: Positive Terminal

## Order Information

Output Voltages	Order Number	Package Mark ID	Package	Supplied as:
1.8V/1.6V	LM2773TL	XV DJ	TLA9ZZA 9-Bump $\mu$ SMD	1000 Units, Tape and Reel
1.8V/1.6V	LM2773TLX	XV DJ		4500 Units, Tape and Reel

## Absolute Maximum Ratings (Notes 2, 3)

If Military/Aerospace specified devices are required, please contact the National Semiconductor Sales Office/Distributors for availability and specifications.

$V_{IN}$ Pin Voltage	-0.3V to 6.0V
EN, SEL Pin Voltage	-0.3V to ( $V_{IN}+0.3V$ ) w/ 6.0V max
Continuous Power Dissipation (Note 4)	Internally Limited
Junction Temperature ( $T_{J-MAX}$ )	150°C
Storage Temperature Range	-65°C to +150°C
Maximum Lead Temperature (Soldering, 10 sec.)	265°C
ESD Rating (Note 5)	
Human Body Model:	2.5kV

## Operating Ratings (Notes 2, 3)

Input Voltage Range	2.5V to 5.5V
Recommended Load Current Range	0mA to 300mA
Junction Temperature ( $T_J$ ) Range	-30°C to +110°C
Ambient Temperature ( $T_A$ ) Range (Note 6)	-30°C to +85°C

## Thermal Properties

Junction-to-Ambient Thermal Resistance ( $\theta_{JA}$ ), $\mu$ SMD-9 Package (Note 7)	75°C/W
--	--------

## Electrical Characteristics (Notes 3, 8)

Limits in standard typeface are for  $T_J = 25^\circ\text{C}$ . Limits in **boldface** type apply over the full operating junction temperature range ( $-30^\circ\text{C} \leq T_J \leq +110^\circ\text{C}$ ). Unless otherwise noted, specifications apply to the LM2773 Typical Application Circuit (pg. 1) with:  $V_{IN} = 3.6V$ ;  $V(EN) = 1.8V$ ,  $V(SEL) = 0V$ ,  $C_{IN} = C_1 = C_2 = 1.0\mu\text{F}$ ,  $C_{OUT} = 4.7\mu\text{F}$ . (Note 10)

Symbol	Parameter	Condition	Min	Typ	Max	Units
$V_{OUT}$	1.8V Mode Output Voltage Regulation	$2.5V \leq V_{IN} \leq 5.5V$ $0mA \leq I_{OUT} \leq 300mA$	<b>1.779</b> (-2%)	1.815	<b>1.851</b> (+2%)	V
	1.6V Mode Output Voltage Regulation	$V(SEL) = 1.8V$ $2.5V \leq V_{IN} \leq 5.5V$ $0mA \leq I_{OUT} \leq 300mA$	<b>1.587</b> (-2%)	1.619	<b>1.651</b> (+2%)	
$V_{OUT}/I_{OUT}$	Output Load Regulation	$0mA \leq I_{OUT} \leq 300mA$		0.15		mV/mA
$V_{OUT}/V_{IN}$	Output Line Regulation			0.3		%/V
E	Power Efficiency	$I_{OUT} = 300mA$		75		%
$I_Q$	Quiescent Supply Current	$I_{OUT} = 0mA$ (Note 11)		48	<b>55</b>	$\mu\text{A}$
$V_R$	Fixed Frequency Output Ripple	$I_{OUT} = 300mA$		10		mV
$V_{R-PFM}$	PFM-Mode Output Ripple	$I_{OUT} < 40mA$		12		mV
$I_{SD}$	Shutdown Current	$V(EN) = 0V$		0.1	<b>0.625</b>	$\mu\text{A}$
$F_{SW}$	Switching Frequency	$3.0V \leq V_{IN} \leq 5.5V$	<b>0.80</b>	1.15	<b>1.50</b>	MHz
$R_{OL}$	Open-Loop Output Resistance	$I_{OUT} = 300mA$ (Note 9)		1.0		$\Omega$
$I_{CL}$	Output Current Limit	$V_{IN} = 5.5V$ $0V \leq V_{OUT} \leq 0.2V$ (Note 13)		500		mA
$t_{ON}$	Turn-on Time			150		$\mu\text{s}$
$V_{IL}$	Logic-low Input Voltage	EN, SEL Pins $2.5V \leq V_{IN} \leq 5.5V$	<b>0</b>		<b>0.5</b>	V
$V_{IH}$	Logic-high Input Voltage	EN, SEL Pins $2.5V \leq V_{IN} \leq 5.5V$	<b>1.0</b>		$V_{IN}$	V
$I_{IH}$	Logic-high Input Current	$V(EN), V(SEL) = 1.8V$ (Note 12)		5		$\mu\text{A}$
$I_{IL}$	Logic-low Input Current	$V(EN), V(SEL) = 0V$		0.01		$\mu\text{A}$

**Note 2:** Absolute Maximum Ratings indicate limits beyond which damage to the component may occur. Operating Ratings are conditions under which operation of the device is guaranteed. Operating Ratings do not imply guaranteed performance limits. For guaranteed performance limits and associated test conditions, see the Electrical Characteristics tables.

**Note 3:** All voltages are with respect to the potential at the GND pins.

**Note 4:** Internal thermal shutdown circuitry protects the device from permanent damage. Thermal shutdown engages at  $T_J=150^{\circ}\text{C}$  (typ.) and disengages at  $T_J=140^{\circ}\text{C}$  (typ.).

**Note 5:** The Human body model is a 100pF capacitor discharged through a 1.5k $\Omega$  resistor into each pin. MIL-STD-883 3015.7

**Note 6:** Maximum ambient temperature ( $T_{A-MAX}$ ) is dependent on the maximum operating junction temperature ( $T_{J-MAX-OP} = 110^{\circ}\text{C}$ ), the maximum power dissipation of the device in the application ( $P_{D-MAX}$ ), and the junction-to ambient thermal resistance of the part/package in the application ( $\theta_{JA}$ ), as given by the following equation:  $T_{A-MAX} = T_{J-MAX-OP} - (\theta_{JA} \times P_{D-MAX})$ .

**Note 7:** Junction-to-ambient thermal resistance is highly application and board-layout dependent. In applications where high maximum power dissipation exists, special care must be paid to thermal dissipation issues.

**Note 8:** Min and Max limits are guaranteed by design, test, or statistical analysis. Typical numbers are not guaranteed, but do represent the most likely norm.

**Note 9:** Open loop output resistance can be used to predict output voltage when, under low  $V_{IN}$  and high  $I_{OUT}$  conditions,  $V_{OUT}$  falls out of regulation.  $V_{OUT} = (\text{Gain})V_{IN} - (R_{OL} \times I_{OUT})$

**Note 10:**  $C_{IN}$ ,  $C_{OUT}$ ,  $C_1$ ,  $C_2$ : Low-ESR Surface-Mount Ceramic Capacitors (MLCCs) used in setting electrical characteristics.

**Note 11:**  $V_{OUT}$  is set to 1.9V during this test (Device is not switching).

**Note 12:** There are 350k $\Omega$  pull-down resistors connected internally between the EN pin and GND and the SEL pin and GND.

**Note 13:** Under the stated conditions, the maximum input current is equal to 2/3 the maximum output current.

## Block Diagram

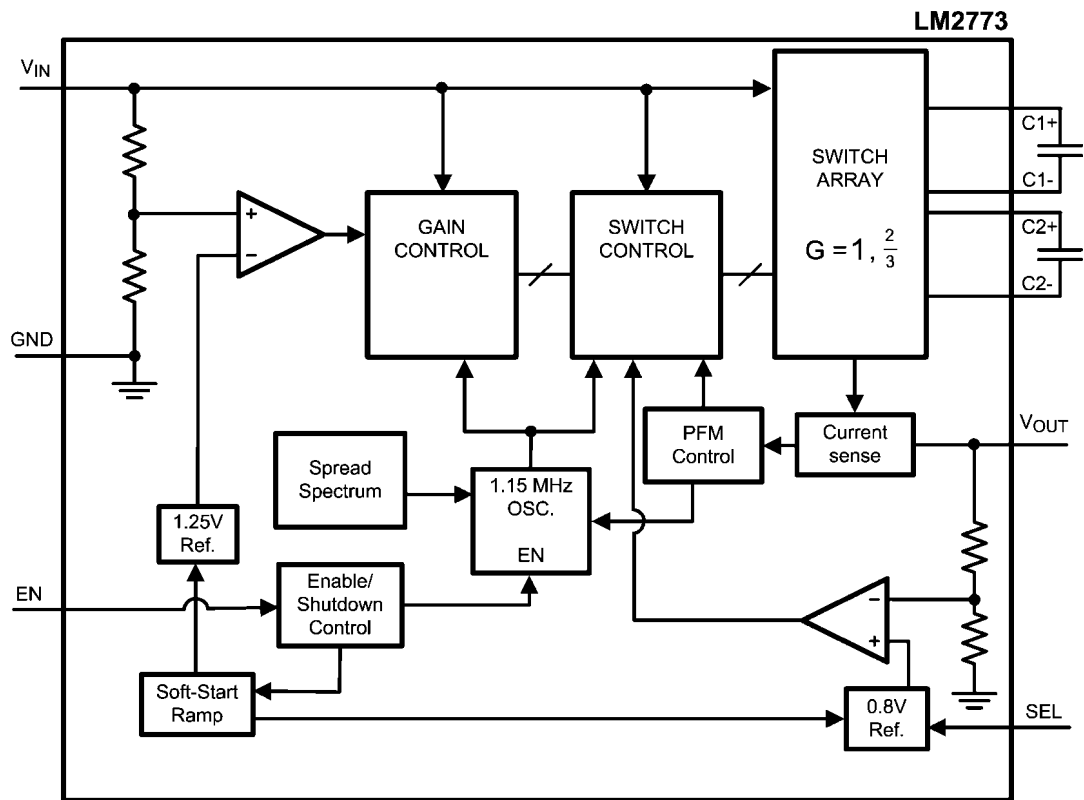

30047403

**Typical Performance Characteristics** Unless otherwise specified:  $V_{IN} = 3.6V$ ,  $C_{IN} = C_1 = C_2 = 1.0\mu F$ ,  $C_{OUT} = 4.7\mu F$ ,  $V(EN) = 1.8V$ ,  $V(SEL) = 0V$ ,  $T_A = 25^\circ C$ . Capacitors are low-ESR multi-layer ceramic capacitors (MLCC's).

**Output Voltage vs. Input Voltage, 1.8V Mode**

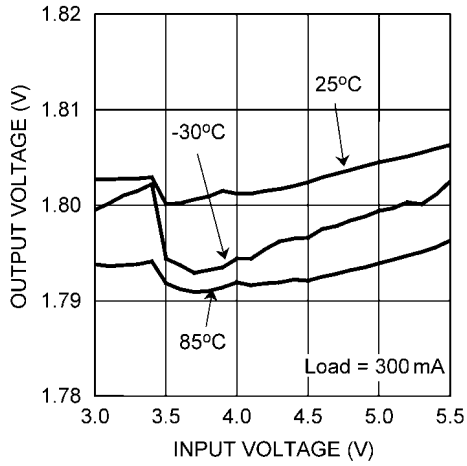

**Output Voltage vs. Input Voltage, 1.6V Mode**

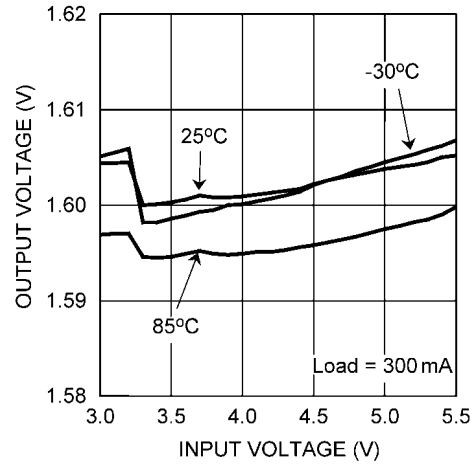

**Output Voltage vs. Output Current, 1.8V Mode**

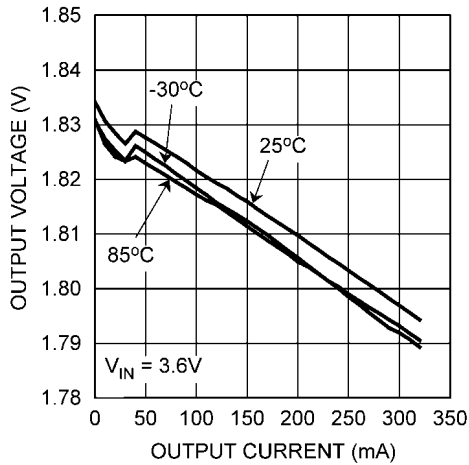

**Output Voltage vs. Output Current, 1.6V Mode**

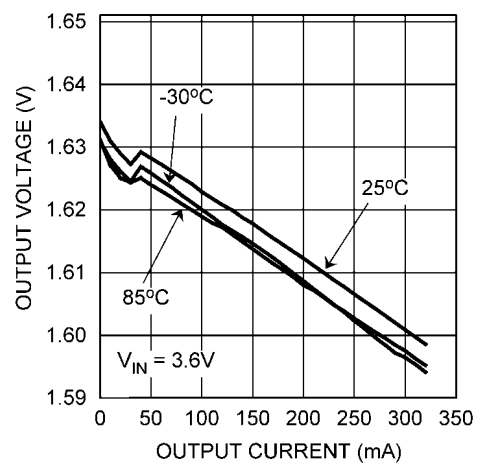

Efficiency vs. Input Voltage, 1.8V Mode

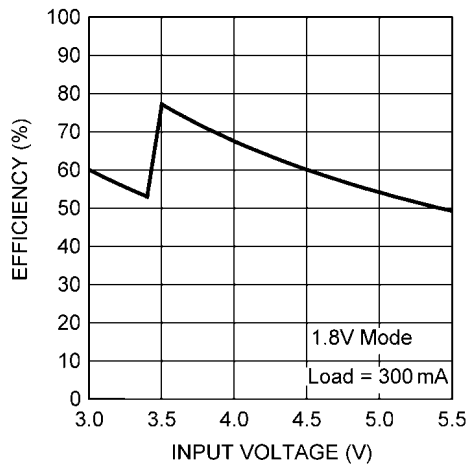

30047408

Efficiency vs. Input Voltage, 1.6V Mode

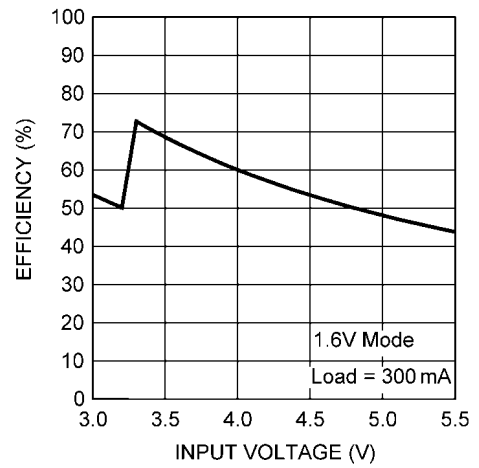

30047409

Shutdown Supply Current

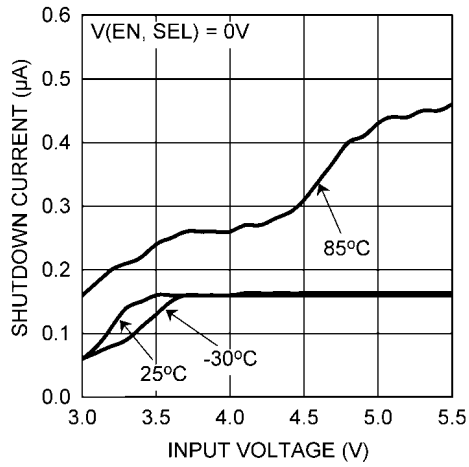

30047412

Operating Supply Current

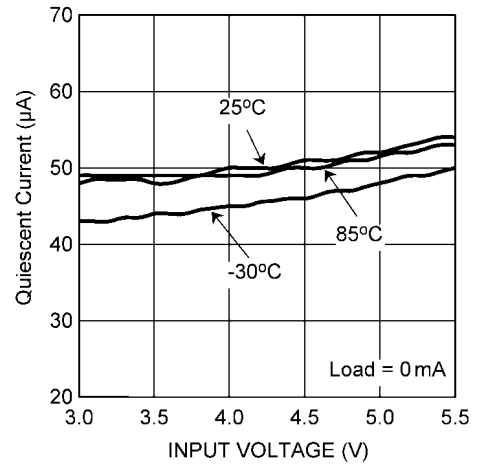

30047411

Line Step 3.0V to 4.2V with Load = 300mA, 1.8V Mode

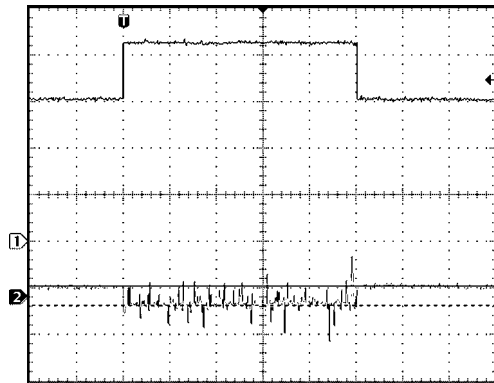

30047413

CH1:  $V_{IN}$ ; Scale: 1V/Div, DC Coupled  
 CH2:  $V_{OUT}$ ; Scale: 20mV/Div, AC Coupled  
 Time scale: 10ms/Div

Line Step 3.0V to 4.2V with Load = 300mA, 1.6V Mode

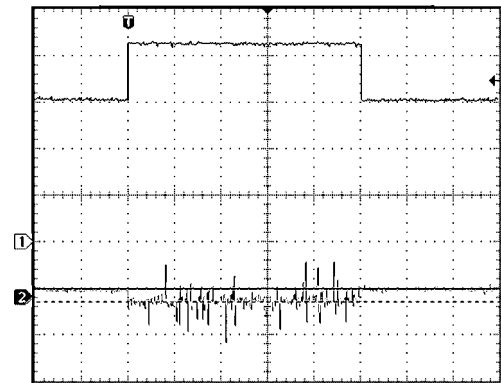

30047414

CH1:  $V_{IN}$ ; Scale: 1V/Div, DC Coupled  
 CH2:  $V_{OUT}$ ; Scale: 20mV/Div, AC Coupled  
 Time scale: 10ms/Div

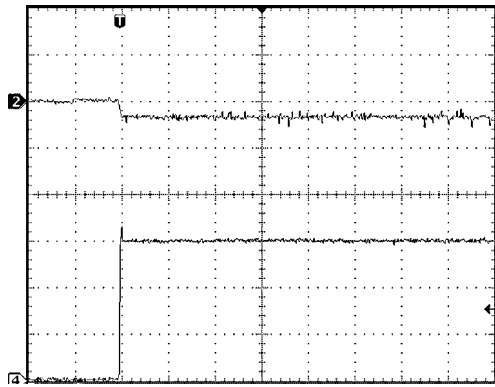
Load Step 0mA to 300mA,  $V_{IN} = 3.6V$ , 1.8V Mode

30047415

CH2:  $V_{OUT}$ ; Scale: 100mV/Div, DC Coupled, Offset 1.834V  
 CH4:  $I_{OUT}$ ; Scale: 100mA/Div  
 Time scale: 4ms/Div

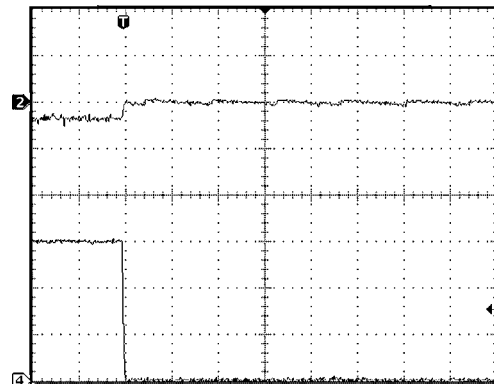
Load Step 300mA to 0mA,  $V_{IN} = 3.6V$ , 1.8V Mode

30047416

CH2:  $V_{OUT}$ ; Scale: 100mV/Div, DC Coupled, Offset 1.834V  
 CH4:  $I_{OUT}$ ; Scale: 100mA/Div  
 Time scale: 4ms/Div

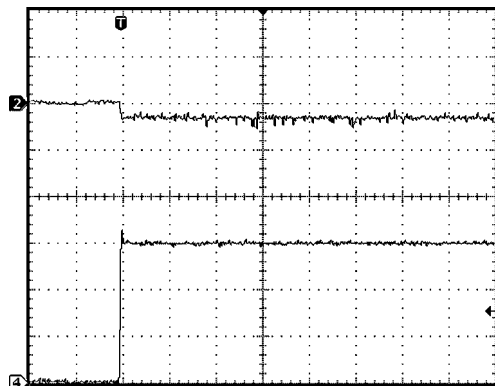
Load Step 0mA to 300mA,  $V_{IN} = 3.6V$ , 1.6V Mode

30047417

CH2:  $V_{OUT}$ ; Scale: 100mV/Div, DC Coupled, Offset 1.633V  
 CH4:  $I_{OUT}$ ; Scale: 100mA/Div  
 Time scale: 4ms/Div

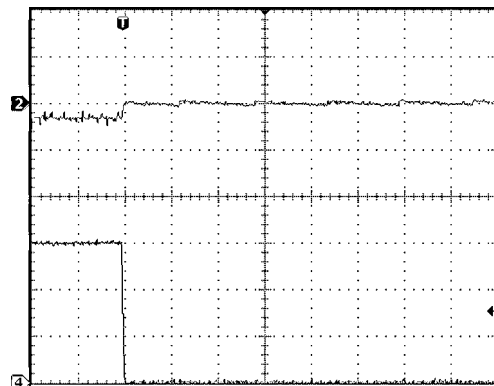
Load Step 300mA to 0mA,  $V_{IN} = 3.6V$ , 1.6V Mode

30047418

CH2:  $V_{OUT}$ ; Scale: 100mV/Div, DC Coupled, Offset 1.633V  
 CH4:  $I_{OUT}$ ; Scale: 100mA/Div  
 Time scale: 4ms/Div

1.8V Mode Startup, Load = 300mA

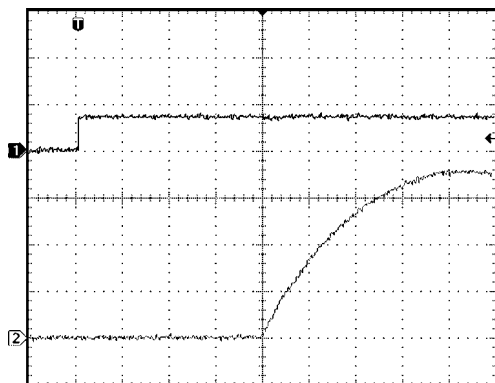

30047419

CH1:  $V_{EN}$ ; Scale: 5V/Div, DC Coupled  
 CH2:  $V_{OUT}$ ; Scale: 500mV/Div, DC Coupled  
 Time scale: 10µs/Div

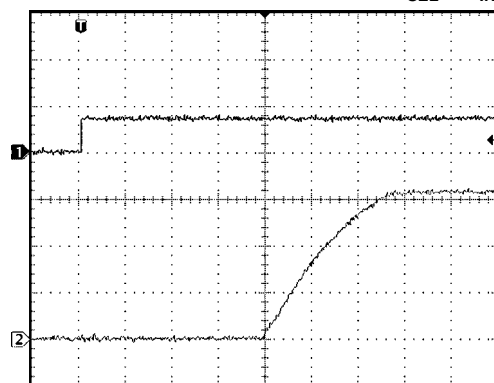
1.6V Mode Startup, Load = 300mA,  $V_{SEL} = V_{IN}$ 

30047420

CH1:  $V_{EN}$ ; Scale: 5V/Div, DC Coupled  
 CH2:  $V_{OUT}$ ; Scale: 500mV/Div, DC Coupled  
 Time scale: 10µs/Div

## Operation Description

### OVERVIEW

The LM2773 is a switched capacitor converter that produces a selectable 1.8V or 1.6V regulated output. The core of the part is a highly efficient charge pump that utilizes fixed frequency pre-regulation, Pulse Frequency Modulation, and spread spectrum to minimize conducted noise and power losses over wide input voltage and output current ranges. A description of the principal operational characteristics of the LM2773 is detailed in the **Circuit Description**, and **Efficiency Performance** sections. These sections refer to details in the **Block Diagram**.

### CIRCUIT DESCRIPTION

The core of the LM2773 is a two-phase charge pump controlled by an internally generated non-overlapping clock. The charge pump operates by using external flying capacitors  $C_1$  and  $C_2$  to transfer charge from the input to the output. The LM2773 will operate in a 1x Gain, with the input current being equal to the load current, when the input voltage is at or below 3.5V (typ.) for 1.8V mode or 3.3V (typ.) for 1.6V mode. At input voltages above 3.5V (typ.) or 3.3V (typ.) for the respective voltage mode selected, the part utilizes a gain of 2/3x, resulting in an input current equal to 2/3 times the load current.

The two phases of the switched capacitor switching cycle will be referred to as the "charge phase" and the "discharge phase". During the charge phase, the flying capacitor is charged by the input supply. After half of the switching cycle [  $t = 1/(2 \times F_{SW})$  ], the LM2773 switches to the discharge phase. In this configuration, the charge that was stored on the flying capacitors in the charge phase is transferred to the output.

The LM2773 uses fixed frequency pre-regulation to regulate the output voltage to 1.8V during moderate to high load currents. The input and output connections of the flying capacitors are made with internal MOS switches. Pre-regulation limits the gate drive of the MOS switch connected between the voltage input and the flying capacitors. Controlling the on resistance of this switch limits the amount of charge transferred into and out of each flying capacitor during the charge and discharge phases, and in turn helps to keep the output ripple very low.

When output currents are low (<40mA typ.), the LM2773 automatically switches to a low-ripple Pulse Frequency Modulation (PFM) form of regulation. In PFM mode, the flying capacitors stay in the discharge phase until the output voltage drops below a predetermined trip point. When this occurs, the flying capacitors switch back to the charge phase. After being charged, the flying capacitors repeat the process of staying in the discharge phase and switching to the charge phase when necessary.

The LM2773 utilizes spread spectrum operation to distribute the peak radiated energy of the device over a wider frequency band, reducing electromagnetic interference (EMI). Spread spectrum is used during all modes of operation for the LM2773.

### EFFICIENCY PERFORMANCE

Charge-pump efficiency is derived in the following two ideal equations (supply current and other losses are neglected for simplicity):

$$E = (V_{OUT} \times I_{OUT}) \div (V_{IN} \times I_{IN}) = V_{OUT} \div (G \times V_{IN})$$

In the equations, G represents the charge pump gain. Efficiency is at its highest as  $G \times V_{IN}$  approaches  $V_{OUT}$ . Refer to

the efficiency graph in the **Typical Performance Characteristics** section for detailed efficiency data. The transition between the gain of 1x and 2/3x is clearly distinguished by the sharp discontinuity in the efficiency curve.

### SHUTDOWN AND VOLTAGE SELECT

The LM2773 is in shutdown mode when the voltage on the enable pin (EN) is logic-low. In shutdown, the LM2773 draws virtually no supply current. When in shutdown, the output of the LM2773 is completely disconnected from the input. Internal feedback resistors pull the output voltage down to 0V during shutdown.

The SEL pin sets the output voltage at either 1.8V or 1.6V. A logic-low voltage on the SEL pin will place the output of the LM2773 in the 1.6V mode, and a logic-high voltage on the SEL pin will place it into the 1.8V mode.

There are 350k $\Omega$  pull-down resistors connected internally between the EN pin and GND and the SEL pin and GND.

### SOFT START

The LM2773 employs soft start circuitry to prevent excessive input inrush currents during startup. At startup, the output voltage gradually rises from 0V to the nominal output voltage. This occurs in 150 $\mu$ s (typ.). Soft-start is engaged when the part is enabled.

### THERMAL SHUTDOWN

Protection from damage related to overheating is achieved with a thermal shutdown feature. When the junction temperature rises to 150°C (typ.), the part switches into shutdown mode. The LM2773 disengages thermal shutdown when the junction temperature of the part is reduced to 140°C (typ.). Due to the high efficiency of the LM2773, thermal shutdown and/or thermal cycling should not be encountered when the part is operated within specified input voltage, output current, and ambient temperature operating ratings. If thermal cycling is seen under these conditions, the most likely cause is an inadequate PCB layout that does not allow heat to be sufficiently dissipated out of the  $\mu$ SMD package.

### CURRENT LIMIT PROTECTION

The LM2773 charge pump contains current limit protection circuitry that protects the device during  $V_{OUT}$  fault conditions where excessive current is drawn. Output current is limited to 500mA (typ.).

## Application Information

### RECOMMENDED CAPACITOR TYPES

The LM2773 requires 4 external capacitors for proper operation. Surface-mount multi-layer ceramic capacitors are recommended. These capacitors are small, inexpensive and have very low equivalent series resistance (ESR,  $\leq 15\text{m}\Omega$  typ.). Tantalum capacitors, OS-CON capacitors, and aluminum electrolytic capacitors generally are not recommended for use with the LM2773 due to their high ESR, as compared to ceramic capacitors.

For most applications, ceramic capacitors with an X7R or X5R temperature characteristic are preferred for use with the LM2773. These capacitors have tight capacitance tolerance (as good as  $\pm 10\%$ ) and hold their value over temperature (X7R:  $\pm 15\%$  over  $-55^\circ\text{C}$  to  $125^\circ\text{C}$ ; X5R:  $\pm 15\%$  over  $-55^\circ\text{C}$  to  $85^\circ\text{C}$ ).

Capacitors with a Y5V or Z5U temperature characteristic are generally not recommended for use with the LM2773. These types of capacitors typically have wide capacitance tolerance



(+80%, -20%) and vary significantly over temperature (Y5V: +22%, -82% over -30°C to +85°C range; Z5U: +22%, -56% over +10°C to +85°C range). Under some conditions, a 1µF-rated Y5V or Z5U capacitor could have a capacitance as low as 0.1µF. Such detrimental deviation is likely to cause Y5V and Z5U capacitors to fail to meet the minimum capacitance requirements of the LM2773.

Net capacitance of a ceramic capacitor decreases with increased DC bias. This degradation can result in lower capacitance than expected on the input and/or output, resulting in higher ripple voltages and currents. Using capacitors at DC bias voltages significantly below the capacitor voltage rating will usually minimize DC bias effects. Consult capacitor manufacturers for information on capacitor DC bias characteristics.

Capacitance characteristics can vary quite dramatically with different application conditions, capacitor types, and capacitor manufacturers. It is strongly recommended that the LM2773 circuit be thoroughly evaluated early in the design-in process with the mass-production capacitors of choice. This will help ensure that any such variability in capacitance does not negatively impact circuit performance.

The table below lists some leading ceramic capacitor manufacturers.

Manufacturer	Contact Information
AVX	www.avx.com
Murata	www.murata.com
Taiyo-Yuden	www.t-yuden.com
TDK	www.component.tdk.com
Vishay-Vitramon	www.vishay.com

#### OUTPUT CAPACITOR AND OUTPUT VOLTAGE RIPPLE

The output capacitor in the LM2773 circuit ( $C_{OUT}$ ) directly impacts the magnitude of output voltage ripple. Other prominent factors also affecting output voltage ripple include input voltage, output current and flying capacitance. Due to the complexity of the regulation topology, providing equations or models to approximate the magnitude of the ripple can not be easily accomplished. But one important generalization can be made: increasing (decreasing) the output capacitance will result in a proportional decrease (increase) in output voltage ripple.

In typical high-current applications, a 4.7µF low-ESR ceramic output capacitor is recommended. Different output capacitance values can be used to reduce ripple, shrink the solution size, and/or cut the cost of the solution. But changing the output capacitor may also require changing the flying capacitor and/or input capacitor to maintain good overall circuit performance. Performance of the LM2773 with different capacitor setups is discussed in the section **Recommended Capacitor Configurations**.

High ESR in the output capacitor increases output voltage ripple. If a ceramic capacitor is used at the output, this is usually not a concern because the ESR of a ceramic capacitor is typically very low and has only a minimal impact on ripple magnitudes. If a different capacitor type with higher ESR is used (tantalum, for example), the ESR could result in high ripple. To eliminate this effect, the net output ESR can be significantly reduced by placing a low-ESR ceramic capacitor in

parallel with the primary output capacitor. The low ESR of the ceramic capacitor will be in parallel with the higher ESR, resulting in a low net ESR based on the principles of parallel resistance reduction.

#### INPUT CAPACITOR AND INPUT VOLTAGE RIPPLE

The input capacitor ( $C_{IN}$ ) is a reservoir of charge that aids a quick transfer of charge from the supply to the flying capacitors during the charge phase of operation. The input capacitor helps to keep the input voltage from drooping at the start of the charge phase when the flying capacitors are connected to the input. It also filters noise on the input pin, keeping this noise out of sensitive internal analog circuitry that is biased off the input line.

Much like the relationship between the output capacitance and output voltage ripple, input capacitance has a dominant, first-order effect on input ripple magnitude. Increasing (decreasing) the input capacitance will result in a proportional decrease (increase) in input voltage ripple. Input voltage, output current, and flying capacitance also will affect input ripple levels to some degree.

In typical high-current applications, a 1µF low-ESR ceramic capacitor is recommended on the input. Different input capacitance values can be used to reduce ripple, shrink the solution size, and/or cut the cost of the solution. But changing the input capacitor may also require changing the flying capacitor and/or output capacitor to maintain good overall circuit performance. Performance of the LM2773 with different capacitor setups is discussed below in **Recommended Capacitor Configurations**.

#### FLYING CAPACITORS

The flying capacitors ( $C_1$ ,  $C_2$ ) transfer charge from the input to the output. Flying capacitance can impact both output current capability and ripple magnitudes. If flying capacitance is too small, the LM2773 may not be able to regulate the output voltage when load currents are high. On the other hand, if the flying capacitance is too large, the flying capacitor might overwhelm the input and output capacitors, resulting in increased input and output ripple.

In typical high-current applications, 1µF low-ESR ceramic capacitors are recommended for the flying capacitors. Polarized capacitors (tantalum, aluminum electrolytic, etc.) must not be used for the flying capacitor, as they could become reverse-biased during LM2773 operation.

#### RECOMMENDED CAPACITOR CONFIGURATIONS

The data in *Table 1* can be used to assist in the selection of capacitance configurations that best balances solution size and cost with the electrical requirements of the application.

As previously discussed, input and output ripple voltages will vary with output current and input voltage. The numbers provided show expected ripple voltage with  $V_{IN} = 3.6V$  and a load current of 300mA. The table offers a first look at approximate ripple levels and provides a comparison of different capacitor configurations, but is not intended to be a guarantee of performance. With any capacitance configuration chosen, always verify that the performance of the ripple waveforms are suitable for the intended application. The same capacitance value must be used for all the flying capacitors.

**TABLE 1. LM2773 Performance with Different Capacitor Configurations, 1.8V Mode** (Note 14)

CAPACITOR CONFIGURATION ( $V_{IN} = 3.6V$ )	TYPICAL OUTPUT RIPPLE
$C_{IN} = 1\mu F$ , $C_{OUT} = 4.7\mu F$ , $C_1, C_2 = 1\mu F$	10mV
$C_{IN} = 1\mu F$ , $C_{OUT} = 2.2\mu F$ , $C_1, C_2 = 1\mu F$	16mV
$C_{IN} = 0.47\mu F$ , $C_{OUT} = 4.7\mu F$ , $C_1, C_2 = 1\mu F$	12mV
$C_{IN} = 0.47\mu F$ , $C_{OUT} = 3.3\mu F$ , $C_1, C_2 = 1\mu F$	12mV
$C_{IN} = 0.47\mu F$ , $C_{OUT} = 3.3\mu F$ , $C_1, C_2 = 0.47\mu F$	13mV

**Note 14:** Refer to the text in the Recommended Capacitor Configurations section for detailed information on the data in this table

## Layout Guidelines

Proper board layout will help to ensure optimal performance of the LM2773 circuit. The following guidelines are recommended:

- Place capacitors as close to the LM2773 as possible, and preferably on the same side of the board as the IC.
- Use short, wide traces to connect the external capacitors to the LM2773 to minimize trace resistance and inductance.
- Use a low resistance connection between ground and the GND pin of the LM2773. Using wide traces and/or multiple vias to connect GND to a ground plane on the board is most advantageous.

**Physical Dimensions** inches (millimeters) unless otherwise noted

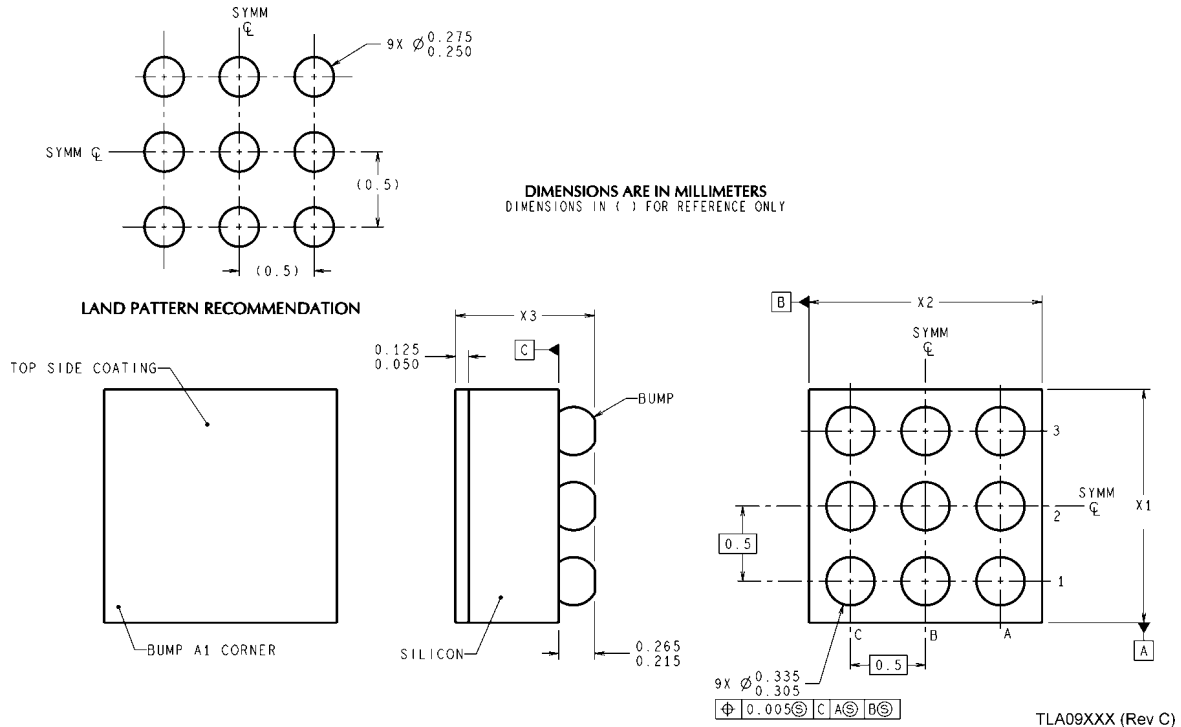

## Notes

For more National Semiconductor product information and proven design tools, visit the following Web sites at:

Products		Design Support	
Amplifiers	<a href="http://www.national.com/amplifiers">www.national.com/amplifiers</a>	WEBENCH	<a href="http://www.national.com/webench">www.national.com/webench</a>
Audio	<a href="http://www.national.com/audio">www.national.com/audio</a>	Analog University	<a href="http://www.national.com/AU">www.national.com/AU</a>
Clock Conditioners	<a href="http://www.national.com/timing">www.national.com/timing</a>	App Notes	<a href="http://www.national.com/appnotes">www.national.com/appnotes</a>
Data Converters	<a href="http://www.national.com/adc">www.national.com/adc</a>	Distributors	<a href="http://www.national.com/contacts">www.national.com/contacts</a>
Displays	<a href="http://www.national.com/displays">www.national.com/displays</a>	Green Compliance	<a href="http://www.national.com/quality/green">www.national.com/quality/green</a>
Ethernet	<a href="http://www.national.com/ethernet">www.national.com/ethernet</a>	Packaging	<a href="http://www.national.com/packaging">www.national.com/packaging</a>
Interface	<a href="http://www.national.com/interface">www.national.com/interface</a>	Quality and Reliability	<a href="http://www.national.com/quality">www.national.com/quality</a>
LVDS	<a href="http://www.national.com/lvds">www.national.com/lvds</a>	Reference Designs	<a href="http://www.national.com/refdesigns">www.national.com/refdesigns</a>
Power Management	<a href="http://www.national.com/power">www.national.com/power</a>	Feedback	<a href="http://www.national.com/feedback">www.national.com/feedback</a>
Switching Regulators	<a href="http://www.national.com/switchers">www.national.com/switchers</a>		
LDOs	<a href="http://www.national.com/ldo">www.national.com/ldo</a>		
LED Lighting	<a href="http://www.national.com/led">www.national.com/led</a>		
PowerWise	<a href="http://www.national.com/powerwise">www.national.com/powerwise</a>		
Serial Digital Interface (SDI)	<a href="http://www.national.com/sdi">www.national.com/sdi</a>		
Temperature Sensors	<a href="http://www.national.com/tempsensors">www.national.com/tempsensors</a>		
Wireless (PLL/VCO)	<a href="http://www.national.com/wireless">www.national.com/wireless</a>		

THE CONTENTS OF THIS DOCUMENT ARE PROVIDED IN CONNECTION WITH NATIONAL SEMICONDUCTOR CORPORATION ("NATIONAL") PRODUCTS. NATIONAL MAKES NO REPRESENTATIONS OR WARRANTIES WITH RESPECT TO THE ACCURACY OR COMPLETENESS OF THE CONTENTS OF THIS PUBLICATION AND RESERVES THE RIGHT TO MAKE CHANGES TO SPECIFICATIONS AND PRODUCT DESCRIPTIONS AT ANY TIME WITHOUT NOTICE. NO LICENSE, WHETHER EXPRESS, IMPLIED, ARISING BY ESTOPPEL OR OTHERWISE, TO ANY INTELLECTUAL PROPERTY RIGHTS IS GRANTED BY THIS DOCUMENT.

TESTING AND OTHER QUALITY CONTROLS ARE USED TO THE EXTENT NATIONAL DEEMS NECESSARY TO SUPPORT NATIONAL'S PRODUCT WARRANTY. EXCEPT WHERE MANDATED BY GOVERNMENT REQUIREMENTS, TESTING OF ALL PARAMETERS OF EACH PRODUCT IS NOT NECESSARILY PERFORMED. NATIONAL ASSUMES NO LIABILITY FOR APPLICATIONS ASSISTANCE OR BUYER PRODUCT DESIGN. BUYERS ARE RESPONSIBLE FOR THEIR PRODUCTS AND APPLICATIONS USING NATIONAL COMPONENTS. PRIOR TO USING OR DISTRIBUTING ANY PRODUCTS THAT INCLUDE NATIONAL COMPONENTS, BUYERS SHOULD PROVIDE ADEQUATE DESIGN, TESTING AND OPERATING SAFEGUARDS.

EXCEPT AS PROVIDED IN NATIONAL'S TERMS AND CONDITIONS OF SALE FOR SUCH PRODUCTS, NATIONAL ASSUMES NO LIABILITY WHATSOEVER, AND NATIONAL DISCLAIMS ANY EXPRESS OR IMPLIED WARRANTY RELATING TO THE SALE AND/OR USE OF NATIONAL PRODUCTS INCLUDING LIABILITY OR WARRANTIES RELATING TO FITNESS FOR A PARTICULAR PURPOSE, MERCHANTABILITY, OR INFRINGEMENT OF ANY PATENT, COPYRIGHT OR OTHER INTELLECTUAL PROPERTY RIGHT.

### LIFE SUPPORT POLICY

**NATIONAL'S PRODUCTS ARE NOT AUTHORIZED FOR USE AS CRITICAL COMPONENTS IN LIFE SUPPORT DEVICES OR SYSTEMS WITHOUT THE EXPRESS PRIOR WRITTEN APPROVAL OF THE CHIEF EXECUTIVE OFFICER AND GENERAL COUNSEL OF NATIONAL SEMICONDUCTOR CORPORATION.** As used herein:

Life support devices or systems are devices which (a) are intended for surgical implant into the body, or (b) support or sustain life and whose failure to perform when properly used in accordance with instructions for use provided in the labeling can be reasonably expected to result in a significant injury to the user. A critical component is any component in a life support device or system whose failure to perform can be reasonably expected to cause the failure of the life support device or system or to affect its safety or effectiveness.

National Semiconductor and the National Semiconductor logo are registered trademarks of National Semiconductor Corporation. All other brand or product names may be trademarks or registered trademarks of their respective holders.

Copyright© 2008 National Semiconductor Corporation

For the most current product information visit us at [www.national.com](http://www.national.com)



**National Semiconductor  
Americas Technical  
Support Center**  
Email:  
[new.feedback@nsc.com](mailto:new.feedback@nsc.com)  
Tel: 1-800-272-9959

**National Semiconductor Europe  
Technical Support Center**  
Email: [europe.support@nsc.com](mailto:europe.support@nsc.com)  
German Tel: +49 (0) 180 5010 771  
English Tel: +44 (0) 870 850 4288

**National Semiconductor Asia  
Pacific Technical Support Center**  
Email: [ap.support@nsc.com](mailto:ap.support@nsc.com)

**National Semiconductor Japan  
Technical Support Center**  
Email: [jpn.feedback@nsc.com](mailto:jpn.feedback@nsc.com)