

**Features:**

- High-Side Current Sense Amplifier
- 2.7V to 40V Input Range
- 0.7% Typical Full Scale Accuracy
- Scalable Output Voltage
- SOIC Package

**Applications:**

- Power Management Systems
- Smart Battery Packs
- Battery Chargers
- Battery Powered Portable Equipment
- DC Motor Control

**General Description**

The IXI848 is a precision high side current sense monitor. High side power-line monitoring offers the advantage of allowing the ground plane to remain undisturbed when sensing load currents.

An external sense resistor sets the range of the amplified ground-referenced output monitoring voltage. The output voltage is amplified by a selectable fixed gain of either 10 or 50. With an input voltage range up to 40V, and output gain of up to 50, the IXI848 is designed to address a wide variety of current sense applications.

The IXI848 operates over a temperature range of  $-40^{\circ}\text{C}$  to  $+85^{\circ}\text{C}$ . The IXI848 is available in an 8-Lead SOIC package.

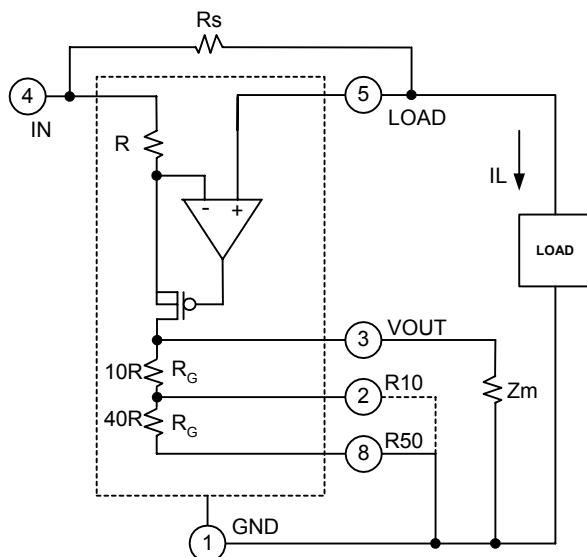
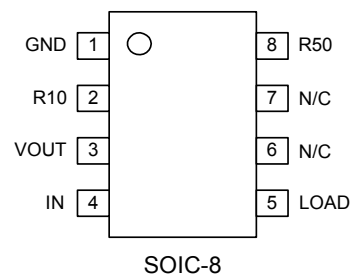
**IXI848 Functional Block Diagram and General Application Circuit**

**IXI848 SOIC PIN Configuration**

**Ordering Information**

Part No.	Description	Package	Quantity
IXI848S1	High Side Current	SOIC-8	98 (Tube)
XI848S1T/R	Sense Monitor	SOIC-8	2500 (T&R)

## Absolute Maximum Ratings

Parameter	Rating
Voltage to IN (pin 4)	-0.3V to +45V
Differential Input Voltage ( $V_{SENSE}$ )	$\pm 0.4V$
Input Current to any pin	$\pm 10mA$
Operating Ambient Temp Range	-40°C to +85°C
Operating Junction Temp Range	-40°C to +125°C
$\theta_{JA}$	150°C/W
$\theta_{JC}$	40°C/W
Storage Temp Range	-65°C to +150°C
Lead Temperature (Soldering, 10 sec)	+300°C

*Absolute Maximum Ratings are stress ratings. Stresses in excess of these ratings can cause permanent damage to the device. Functional operation of the device at these or any other conditions beyond those indicated in the operational sections of this data sheet is not implied. Exposure of the device to the absolute maximum ratings for an extended period may degrade the device and affect its reliability.*

## ESD Warning

ESD (electrostatic discharge) sensitive device. Although the IXI848 feature proprietary ESD protection circuitry, permanent damage may be sustained if subjected to high energy electrostatic discharges. Proper ESD precautions are recommended to avoid performance degradation or loss of functionality.

## Electrical Characteristics

$T_A = 25^\circ C$ ,  $V_{IN} = 2.7V$  to  $40V$ , unless otherwise noted

Parameter	Symbol	Conditions	Min	Typ	Max	Unit	
Operating Voltage Range	$V_{IN}$		2.7		40	V	
Supply Current	$I_{IN}$	$V_{IN} = 20V$ , $V_{SENSE} = 0V$ , $I_{LOAD} = 0A$		.065	.130	mA	
Full Scale Sense Voltage	$V_{SENSE}$			150		mV	
Input Offset Voltage	$V_{OS}$	$V_{IN} = 12V$	-2.0	$\pm 0.5$	2.0	mV	
Full Scale Accuracy		$V_{SENSE} = 100mV$ , $V_{IN} = 12V$ $T_A = +25^\circ C$		$\pm 0.7$		%	
Total OUT Voltage Error (Note 1, Note 2)		$V_{SENSE} = 100mV$ $V_{IN} = 12V$	$T_A = +25^\circ C$	$\pm 0.7$		%	
			$\Delta @ T_A = -40^\circ$ to $+85^\circ C$	$\pm 0.3$			
Gain Accuracy (Note 2)		$V_{SENSE} = 100mV$ $V_{IN} = 40V$	$T_A = +25^\circ C$	$\pm 0.8$		%	
			$\Delta @ T_A = -40^\circ$ to $+85^\circ C$	$\pm 0.4$			
Gain Accuracy (Note 2)		$V_{SENSE} = 20mV$ to $100mV$ $V_{IN} = 12V, 40V$	$T_A = +25^\circ C$	$\pm 0.5$		%	
			$\Delta @ T_A = -40^\circ$ to $+85^\circ C$	$\pm 0.1$			
Gain Setting Resistance	$R_G$	$V_{IN} = 12V$ $V_{SENSE} = 100mV$	Gain = 10V/V	23	33	43	k $\Omega$
			Gain = 50V/V	115	165	215	k $\Omega$

Note 1: Total OUT voltage error is the sum of gain and offset voltage errors.

Note 2: Production Tested at  $T_A = 25^\circ C$ .

## Pin Description and Configuration

SOIC	Name	Description
1	GND	Ground
2	R10	Connecting R10 to GND, (R50=N/C) selects a VOUT voltage that is 10X the voltage across R <sub>SENSE</sub> .
3	VOUT	Output voltage proportional to the voltage across R <sub>SENSE</sub> .
4	IN	Positive supply terminal and power connection for the external Sense Resistor.
5	LOAD	Load-side connection to the external Sense Resistor.
6	N/C	No Connect
7	N/C	No Connect
8	R50	Connecting R50 to GND, (R10=N/C) selects a VOUT voltage that is 50X the voltage across R <sub>SENSE</sub> .

## Detailed Circuit Description

The IXI848 is a precision high side current sense monitor featuring an input voltage range of 2.7V to 40V, and a selectable ground referenced fixed gain output of either 10 or 50.

A small voltage developed across an external sense resistor ( $R_S$ ), is converted to an amplified ground referenced voltage output at VOUT, (Figure 1). The amplifier's non-inverting input is high impedance making the voltage at that terminal equal to  $V_{IN} - (I_L)(R_S)$ . The amplifier forces the high impedance inverting terminal to equal the non-inverting input voltage by turning on the P-Channel MOS FET.

As the P-Channel MOS FET is biased on by the amplifier output, current is sourced through  $R_G$  (10R or 10R+40R), to produce a voltage equal to  $V_{IN} - (I_L)(R_S)$  at the inverting input of the amplifier. This develops a voltage across the inverting input resistor, R that matches the sense voltage across  $R_S$ , plus any associated input offset voltage, ( $V_{IO}$ ). Consequently, the voltage at VOUT corresponds to  $R_G / R$ .

Output:  $VOUT = G [(I_L)(R_S) + V_{IO}]$

Gain:  $G = (R_G)(Z_M) / R (R_G + Z_M)$

$R_G = 10R$  or  $50R$  selectable

Temperature coefficient:

(all on-chip resistors)  $R = 700\text{ppm} / ^\circ\text{C}$  typical

### R<sub>SENSE</sub> Component Selection

The  $R_{SENSE}$  value should be selected such that the voltage across  $R_{SENSE}$  is at full-scale for the load current to be monitored. Operating the IXI848 at or near the full-scale sense voltage will minimize the

error component associated with the input offset voltage of the internal op amp.

The IXI848 can be configured to measure a wide selection of currents by using different  $R_{SENSE}$  values. Some common values for typical operation of the IXI848 are listed in the following table.

Full-Scale $I_L$ (A)	$R_{SENSE}$ $R_S$ ( $\Omega$ )	Gain (V/V)	VOUT (V) $V_{SENSE} = 150\text{mV}$
0.15	1.0	10	1.5
1.5	0.1	10	1.5
5	0.01	50	2.5
100	0.001	50	5

### Output Impedance

The VOUT output is a current source driving a  $33\text{k}\Omega$  resistance to ground for a gain of 10, or a  $165\text{k}\Omega$  resistance to ground for a gain of 50. Output gain is reduced by resistive loading of the VOUT terminal. The impedance of the external monitor load ( $Z_M$ ) should be chosen high enough to maintain the desired accuracy. Buffering of the VOUT terminal with a high-impedance input stage may be required to minimize output errors.

The following formulas quantify the percent error introduced by output loading:

For a Gain of 10

$$\%_{\text{ERROR}} = 100 [R_{\text{LOAD}} / (33\text{k}\Omega + R_{\text{LOAD}}) - 1]$$

For a Gain of 50

$$\%_{\text{ERROR}} = 100 [R_{\text{LOAD}} / (165\text{k}\Omega + R_{\text{LOAD}}) - 1]$$

$R_{\text{LOAD}} =$  the external load applied to VOUT

Typical Performance Characteristics

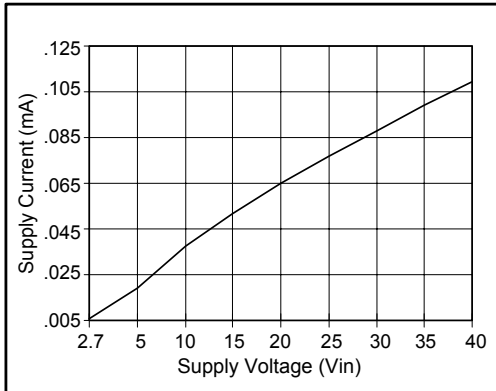

Fig 3. Supply Current vs. Voltage

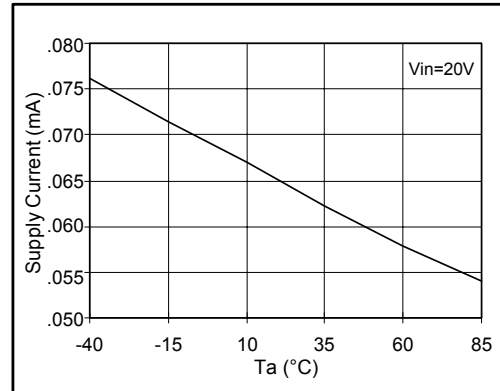

Fig 4. Supply Current vs. Temperature

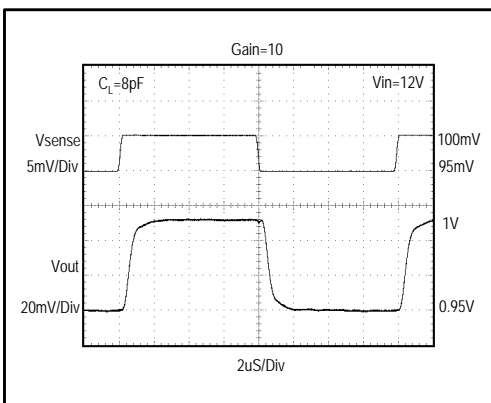

Fig 5. Small Signal Transient Response 10X

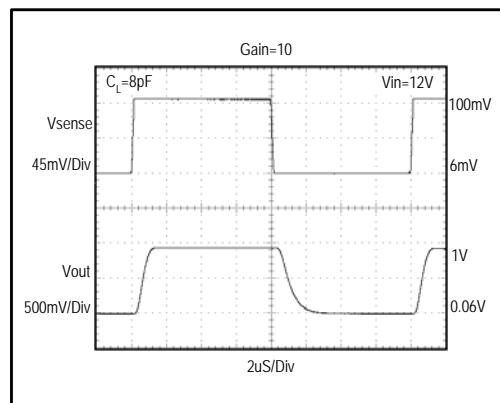

Fig 6. Large Signal Transient Response 10X

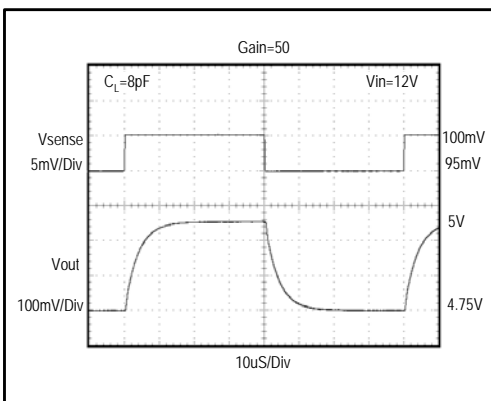

Fig 7. Small Signal Transient Response 50X

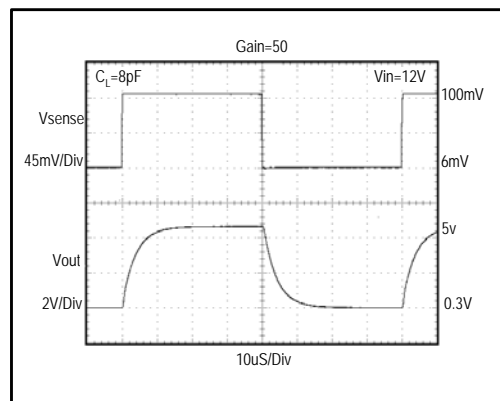
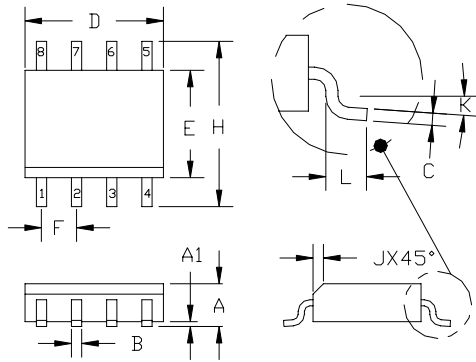

Fig 8. Large Signal Transient Response 50X

## Package Outline

## 8-LEAD SOIC



DIM.	DIMENSIONS <sup>①</sup>				NOTE
	INCH		MM.		
	MIN.	MAX.	MIN.	MAX.	
A	.0532	.0688	1.35	1.75	----
A1	.0040	.0098	.10	.25	----
B	.013	.020	.33	.51	----
C	.0075	.0098	.19	.25	----
D	.1890	.1968	4.80	5.00	②
E	.1497	.1574	3.80	4.00	②
F	.050	BSC	1.27	BSC	----
H	.2284	.2440	5.80	6.20	----
J	.0099	.0196	.25	.50	----
K	0°	8°	0°	8°	----
L	.016	.050	.40	1.27	----

3. MOLDED PACKAGE SHALL CONFORM TO JEDEC STANDARD CONFIGURATION MS-012 VARIATION AA.

② DIMENSIONS D AND E DO NOT INCLUDE MOLD PROTRUSIONS.

① CONTROLLING DIMENSIONS: MILLIMETERS.

NOTES: (UNLESS OTHERWISE SPECIFIED)

IXYS Corporation makes no representations or warranties with respect to the accuracy or completeness of the contents of this publication and reserves the right to make changes to specifications and product descriptions at any time without notice. Neither circuit patent licenses nor indemnity are expressed or implied. Except as set forth in IXYS' Standard Terms and Conditions of Sale, IXYS Corporation assumes no liability whatsoever, and disclaims any expressed or implied warranty, relating to its products including, but not limited to, the implied warranty of merchantability, fitness for a particular purpose, or infringement of any intellectual property right.