



CURRENT-MODE PWM CONTROLLER

The KA3842A are fixed frequency current-mode PWM controller. They are specially designed for OFF-Line and DC-to-DC converter applications with minimal external components. These integrated circuits feature a trimmed oscillator for precise duty cycle control, a temperature compensated reference, high gain error amplifier, current sensing comparator, and a high current totempole output ideally suited for driving a power MOSFET.

Protection circuitry includes built under-voltage lockout and current limiting.

The KA3842A, KA384AM can

The KA3842A have Start-Up Current 0,45 mA

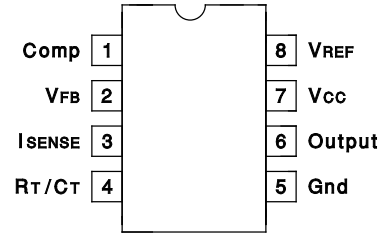

FEATURES

- Low Start-Up Current
- Maximum Duty Cycle
- U/V Lockout With Hysteresis
- Operating Frequency Up To 500kHz

ordering information

Device	Package	Operating temperature
KA3842AM	SO-8	0 to +70°C

BLOCK DIAGRAM

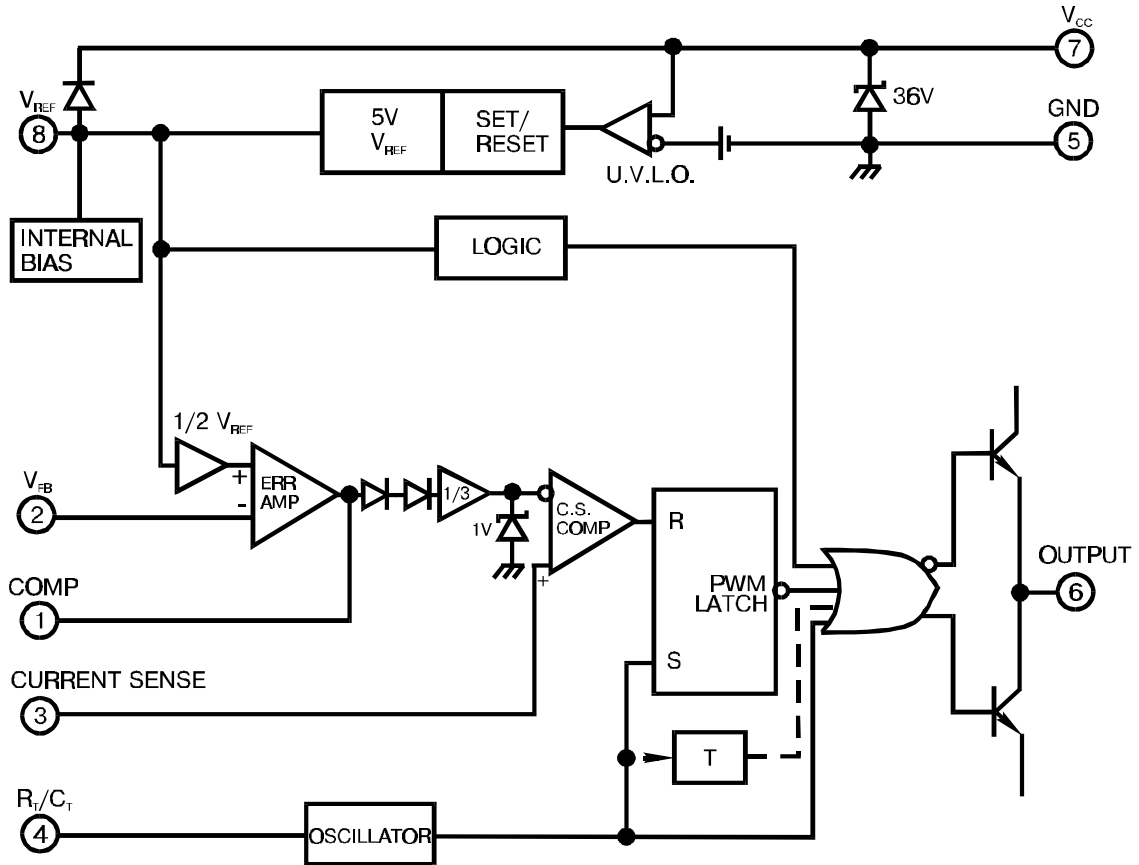

Absolute Maximum Ratings

Characteristic	Symbol	Value	Unit
Supply Voltage	V _{CC}	30	V
Output Current	I _O	±1	A
Analog Inputs	V _I	-0.3 to V _{CC}	V
Error Amp Output Sink Current	I _{SINK (E.A)}	10	mA
Power Dissipation (T _A =25°C)	P _O	1	W



Electrical characteristics (*V_{CC}=15V, R_T=10kΩ, C_T=3.3nF, T_A=0°C to +70°C, unless otherwise specified)

Characteristics	Symbol	Test Condition	Min	Typ	Max	Unit
Reference Section						
Reference Output Voltage	V _{REF}	T _J = 25°C, I _{REF} = 1 mA	4.9	5.0	5.1	V
Line Regulation	ΔV _{REF}	12V ≤ V _{CC} ≤ 25 V		6.0	20	mV
Load Regulation	ΔV _{REF}	1 mA ≤ I _{REF} ≤ 20mA		6.0	25	
Short Circuit Output Current	I _{SC}	T _A = 25°C		-100	-180	mA
Oscillator Section						
Oscillation Frequency	f	T _J = 25°C	47	52	57	KHz
Frequency Change with Voltage	Δf/ΔV _{CCF}	12V ≤ V _{CC} ≤ 25 V		0.05	1.0	%
Oscillator Amplitude	V _(OSC)			1.6		V _{p-p}
Error Amplifier Section						
Input Bias Current	I _{BIAS}			-0.1	-2	μA
Input Voltage	V _{I(E.A)}	V ₁ = 2.5V	2.42	2.5	2.58	V
Open Loop Voltage Gain	G _{VO}	2V ≤ V _O ≤ 4V	65	90		dB
Power Supply Rejection Ratio	PSRR	12V ≤ V _{CC} ≤ 25 V	60	70		
Output Sink Current	I _{SINK}	V ₂ = 2.7V, V ₁ = 1.1V	2	7		mA
Output Source Current	I _{SOURCE}	V ₂ = 2.3V, V ₁ = 5V	-0.5	-1.0		mA
High Output Voltage	V _{OH}	V ₂ = 2.3V, R _L = 15KΩ to GND	5.0	6.0		V
Low Output Voltage	V _{OL}	V ₂ = 2.7V, R _L = 15KΩ to PIN 8		0.8	1.1	
Current Sense Section						
Gain	G _V	(Note 1 & 2)	2.85	3.0	3.15	V/V
Maximum Input Signal	V _{I(MAX)}	V ₁ = 5V (Note1)	0.9	1.0	1.1	V
Power Supply Rejection Ratio	PSRR	12V ≤ V _{CC} ≤ 25 V (Note 1)		70		dB
Input Bias Current	I _{BIAS}			-3.0	-10	μA
Output Section						
Low Output Voltage	V _{OL}	I _{SINK} = 20 mA		0.08	0.4	V
		I _{SINK} = 200 mA		1.4	2.2	
High Output Voltage	V _{OH}	I _{SINK} = 20 mA	13	13.5		
		I _{SINK} = 200 mA	12	13.0		
Rise Time	t _R	T _J = 25°C, C _L = 1nF (Note 3)		45	150	nS
Fall Time	t _F	T _J = 25°C, C _L = 1nF (Note 3)		35	150	
Under-Voltage Lockout Section						
Start Theshold	V _{TH(ST)}		14.5	16.0	17.5	V
Min. Operating Voltage (After Turn On)	V _{OPR(min)}		8.5	10	11.5	V
PWM Section						
Max. Duty Cycle	D _(MAX)		95	97	100	%
Min. Duty Cycle	D _(MAX)				0	
Total Standby Current						
Start-Up Current	I _{ST}			0.17	0.3	mA
Operating Supply Current	I _{CC (OPR)}	V ₃ = V ₂ = 0V		14	17	
Zener Voltage	V _Z		30	38		V

* Adjust V_{CC} above the start threshold before setting at 15V

Note 1: Parameter measured at trip point of I_{ATH} with V₂=0

Note 2: Gain defined as A=ΔV₁/ΔV₃ ; 0 ≤ V₃ ≤ 0.8V

Note 3: These parameters, although guaranteed, are not 100% tested in production.

Pad Location

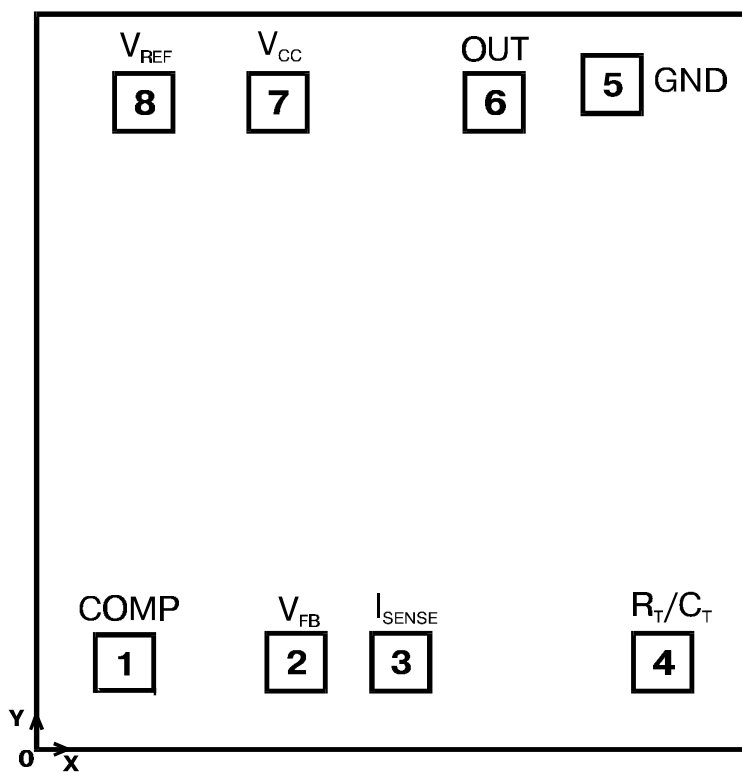

Chip size: 2.38 x 1.63 mm

Pad N	Coordinates μm		Pad N	Coordinates μm	
	X	Y		X	Y
1	90	110	5	1680	1450
2	1050	110	6	1310	1410
3	1310	110			
4	2000	150	7	815	1410
			8	460	1390

DIM.	mm			inch		
	MIN.	TYP.	MAX.	MIN.	TYP.	MAX.
A			1.75			0.069
a1	0.1		0.25	0.004		0.010
a2			1.65			0.065
a3	0.65		0.85	0.026		0.033
b	0.35		0.48	0.014		0.019
b1	0.19		0.25	0.007		0.010
C	0.25		0.5	0.010		0.020
c1	45° (typ.)					
D (1)	4.8		5.0	0.189		0.197
E	5.8		6.2	0.228		0.244
e		1.27			0.050	
e3		3.81			0.150	
F (1)	3.8		4.0	0.15		0.157
L	0.4		1.27	0.016		0.050
M			0.6			0.024
S	8° (max.)					

OUTLINE AND MECHANICAL DATA

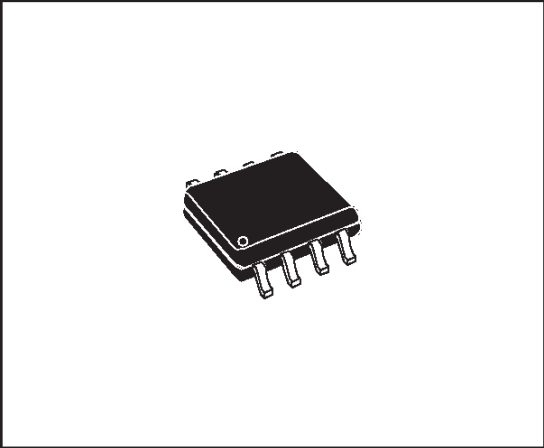

SO8

(1) D and F do not include mold flash or protrusions. Mold flash or protrusions shall not exceed 0.15mm (.006inch).

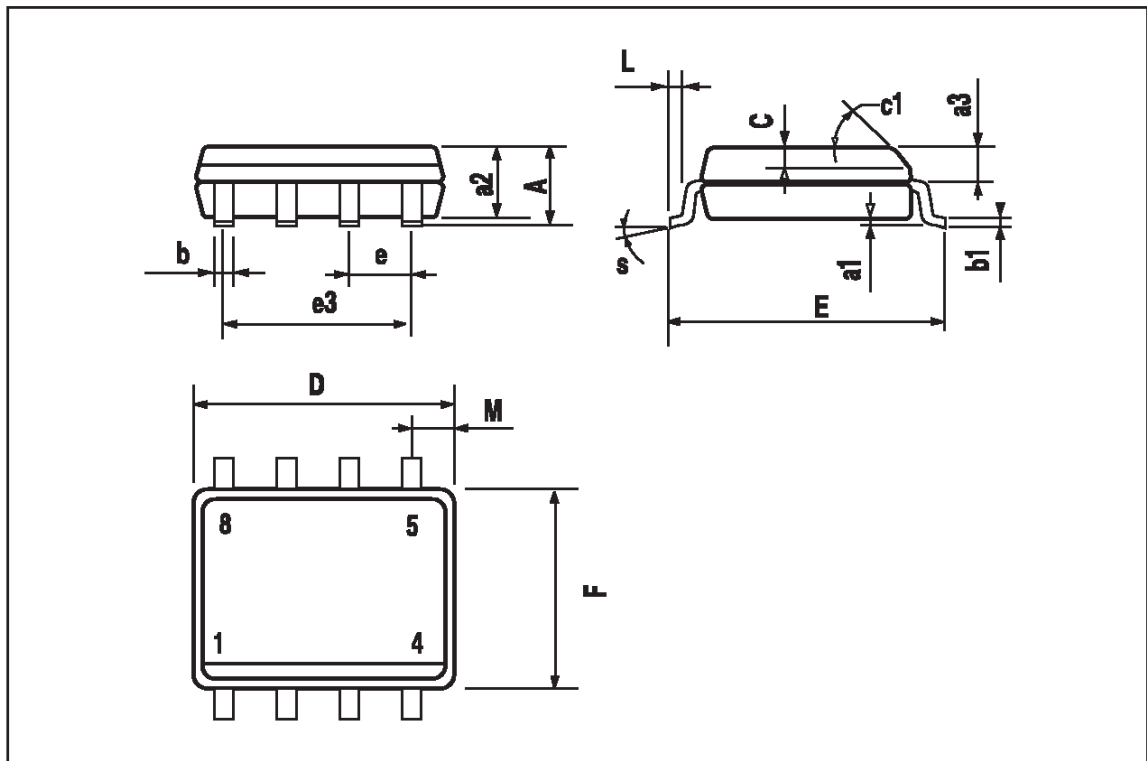

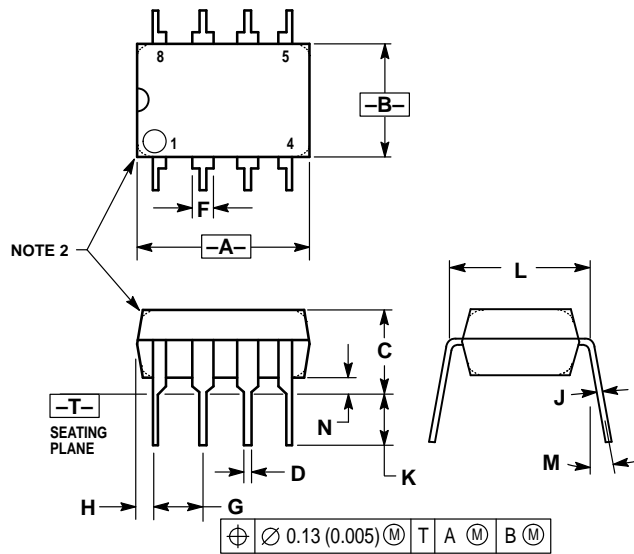

- NOTES:
1. DIMENSION L TO CENTER OF LEAD WHEN FORMED PARALLEL.
 2. PACKAGE CONTOUR OPTIONAL (ROUND OR SQUARE CORNERS).
 3. DIMENSIONING AND TOLERANCING PER ANSI Y14.5M, 1982.

DIM	MILLIMETERS		INCHES	
	MIN	MAX	MIN	MAX
A	9.40	10.16	0.370	0.400
B	6.10	6.60	0.240	0.260
C	3.94	4.45	0.155	0.175
D	0.38	0.51	0.015	0.020
F	1.02	1.78	0.040	0.070
G	2.54 BSC		0.100 BSC	
H	0.76	1.27	0.030	0.050
J	0.20	0.30	0.008	0.012
K	2.92	3.43	0.115	0.135
L	7.62 BSC		0.300 BSC	
M	—		10°	
N	0.76	1.01	0.030	0.040