

## FEATURES

### Extremely low harmonic distortion

- 112 dBc HD2 @ 10 MHz
- 84 dBc HD2 @ 70 MHz
- 77 dBc HD2 @ 100 MHz
- 102 dBc HD3 @ 10 MHz
- 91 dBc HD3 @ 70 MHz
- 84 dBc HD3 @ 100 MHz

### Low input voltage noise: 2.2 nV/ $\sqrt{\text{Hz}}$

### High speed

- 3 dB bandwidth of 1.9 GHz,  $G = 1$
- Slew rate: 6000 V/ $\mu\text{s}$ , 25% to 75%

### Fast overdrive recovery of 1 ns

### 0.5 mV typical offset voltage

### Externally adjustable gain

### Differential-to-differential or single-ended-to-differential operation

### Adjustable output common-mode voltage

### Single-supply operation: 3.3 V to 5 V

## APPLICATIONS

### ADC drivers

### Single-ended-to-differential converters

### IF and baseband gain blocks

### Differential buffers

### Line drivers

## GENERAL DESCRIPTION

The ADA4937 is a low noise, ultralow distortion, high speed differential amplifier. It is an ideal choice for driving high performance ADCs with resolutions up to 16 bits from dc to 100 MHz. The adjustable level of the output common mode allows the ADA4937 to match the input of the ADC. The internal common-mode feedback loop also provides exceptional output balance as well as suppression of even-order harmonic distortion products.

With the ADA4937, differential gain configurations are easily realized with a simple external feedback network of four resistors that determine the closed-loop gain of the amplifier.

The ADA4937 is fabricated using Analog Devices, Inc. proprietary silicon-germanium (SiGe), complementary bipolar process, enabling it to achieve very low levels of distortion with an input voltage noise of only 2.2 nV/ $\sqrt{\text{Hz}}$ . The low dc offset and excellent dynamic performance of the ADA4937 make it well suited for a wide variety of data acquisition and signal processing applications.

### Rev. A

Information furnished by Analog Devices is believed to be accurate and reliable. However, no responsibility is assumed by Analog Devices for its use, nor for any infringements of patents or other rights of third parties that may result from its use. Specifications subject to change without notice. No license is granted by implication or otherwise under any patent or patent rights of Analog Devices. Trademarks and registered trademarks are the property of their respective owners.

## FUNCTIONAL BLOCK DIAGRAMS

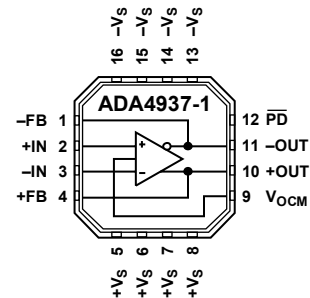

Figure 1. ADA4937-1

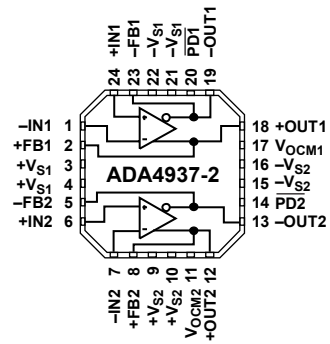

Figure 2. ADA4937-2

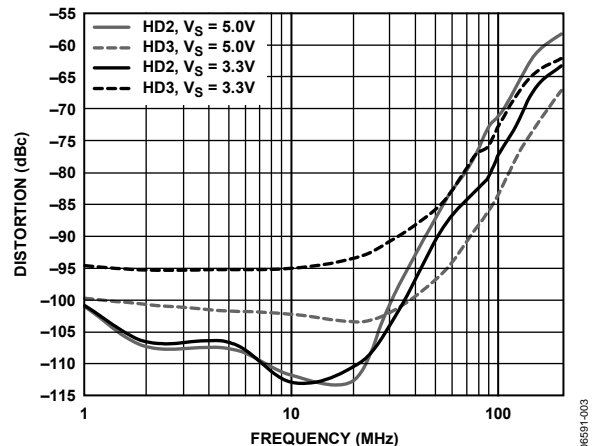

Figure 3. Harmonic Distortion vs. Frequency

The ADA4937 is available in a Pb-free, 3 mm  $\times$  3 mm 16-lead LFCSP (ADA4937-1, single) or a Pb-free, 4 mm  $\times$  4 mm 24-lead LFCSP (ADA4937-2, dual). The pinout has been optimized to facilitate PCB layout and minimize distortion. The ADA4937-1 is specified to operate over the  $-40^{\circ}\text{C}$  to  $+105^{\circ}\text{C}$  temperature range, and the ADA4937-2 operates over  $-40^{\circ}\text{C}$  to  $+85^{\circ}\text{C}$ ; both operate at 3.3 V and 5 V supplies.

## TABLE OF CONTENTS

Features .....	1	Theory of Operation .....	18
Applications.....	1	Analyzing an Application Circuit .....	18
General Description .....	1	Setting the Closed-Loop Gain .....	18
Functional Block Diagrams.....	1	Estimating the Output Noise Voltage .....	18
Revision History .....	2	Impact of Mismatches in the Feedback Networks .....	19
Specifications.....	3	Calculating the Input Impedance for an Application	
5 V Operation .....	3	Circuit .....	19
3.3 V Operation .....	5	Input Common-Mode Voltage Range in Single-Supply	
Absolute Maximum Ratings.....	7	Applications .....	20
Thermal Resistance .....	7	Setting the Output Common-Mode Voltage.....	20
ESD Caution.....	7	Layout, Grounding, and Bypassing.....	22
Pin Configuration and Function Descriptions.....	8	High Performance ADC Driving .....	23
Typical Performance Characteristics .....	9	3.3 V Operation .....	25
Test Circuits.....	16	Outline Dimensions .....	26
Operational Description.....	17	Ordering Guide .....	26
Definition of Terms.....	17		

## REVISION HISTORY

### 11/07—Rev. 0 to Rev. A

Added the ADA4937-2 .....	Universal
Changes to Features.....	1
Changes to Specifications .....	3
Changes to Figure 4.....	7
Changes to Typical Performance Characteristics.....	9
Inserted Figure 44.....	15
Added the Terminating a Single-Ended Input Section .....	19
Changes to Table 10 and Table 11 .....	21
Changes to Layout, Grounding, and Bypassing Section .....	22
Inserted Figure 59, Figure 60, and Figure 61 .....	22
Updated Outline Dimensions .....	26
Changes to Ordering Guide .....	26

### 5/07—Revision 0: Initial Version

# SPECIFICATIONS

## 5 V OPERATION

$T_A = 25^\circ\text{C}$ ,  $+V_S = 5\text{ V}$ ,  $-V_S = 0\text{ V}$ ,  $V_{OCM} = +V_S/2$ ,  $R_T = 61.9\ \Omega$ ,  $R_G = R_F = 200\ \Omega$ ,  $G = 1$ ,  $R_{L, dm} = 1\text{ k}\Omega$ , unless otherwise noted.  
 All specifications refer to single-ended input and differential outputs, unless otherwise noted.

### $\pm D_{IN}$ to $\pm OUT$ Performance

Table 1.

Parameter	Conditions	Min	Typ	Max	Unit
<b>DYNAMIC PERFORMANCE</b>					
-3 dB Small Signal Bandwidth	$V_{OUT, dm} = 0.1\text{ V p-p}$		1900		MHz
Bandwidth for 0.1 dB Flatness	$V_{OUT, dm} = 0.1\text{ V p-p}$		200		MHz
Large Signal Bandwidth	$V_{OUT, dm} = 2\text{ V p-p}$		1700		MHz
Slew Rate	$V_{OUT, dm} = 2\text{ V p-p}$ ; 25% to 75%		6000		V/ $\mu\text{s}$
Overdrive Recovery Time	$V_{IN} = 0\text{ V}$ to 1.5 V step; $G = 3.16$		<1		ns
<b>NOISE/HARMONIC PERFORMANCE</b>					
See Figure 48 for distortion test circuit					
Second Harmonic	$V_{OUT, dm} = 2\text{ V p-p}$ ; 10 MHz		-112		dBc
	$V_{OUT, dm} = 2\text{ V p-p}$ ; 70 MHz		-84		dBc
	$V_{OUT, dm} = 2\text{ V p-p}$ ; 100 MHz		-77		dBc
Third Harmonic	$V_{OUT, dm} = 2\text{ V p-p}$ ; 10 MHz		-102		dBc
	$V_{OUT, dm} = 2\text{ V p-p}$ ; 70 MHz		-91		dBc
	$V_{OUT, dm} = 2\text{ V p-p}$ ; 100 MHz		-84		dBc
IMD	$f_1 = 70\text{ MHz}$ ; $f_2 = 70.1\text{ MHz}$ ; $V_{OUT, dm} = 2\text{ V p-p}$		-91		dBc
Voltage Noise (RTI)	$f = 100\text{ kHz}$		2.2		nV/ $\sqrt{\text{Hz}}$
Input Current Noise	$f = 100\text{ kHz}$		4		pA/ $\sqrt{\text{Hz}}$
Noise Figure	$G = 4$ ; $R_T = 136\ \Omega$ ; $R_F = 200\ \Omega$ ; $R_G = 37\ \Omega$ ; $f = 100\text{ MHz}$		15		dB
Crosstalk (ADA4937-2)	$f = 100\text{ MHz}$		-72		dB
<b>INPUT CHARACTERISTICS</b>					
Offset Voltage	$V_{OS, dm} = V_{OUT, dm}/2$ ; $V_{DIN+} = V_{DIN-} = 2.5\text{ V}$	-2.5	$\pm 0.5$	+2.5	mV
	$T_{MIN}$ to $T_{MAX}$ variation		$\pm 1$		$\mu\text{V}/^\circ\text{C}$
Input Bias Current	$T_{MIN}$ to $T_{MAX}$ variation	-30	-21	-10	$\mu\text{A}$
	$T_{MIN}$ to $T_{MAX}$ variation		0.01		$\mu\text{A}/^\circ\text{C}$
Input Offset Current		-2	+0.5	+2	$\mu\text{A}$
Input Resistance	Differential		6		M $\Omega$
	Common mode		3		M $\Omega$
Input Capacitance			1		pF
Input Common-Mode Voltage			0.3 to 3.0		V
CMRR	$\Delta V_{OUT, dm}/\Delta V_{IN, cm}$ ; $\Delta V_{IN, cm} = \pm 1\text{ V}$	-69	-80		dB
<b>OUTPUT CHARACTERISTICS</b>					
Output Voltage Swing	Maximum $\Delta V_{OUT}$ ; single-ended output; $R_F = R_G = 10\text{ k}\Omega$	0.9		4.1	V
Linear Output Current			>100		mA
Output Balance Error	$\Delta V_{OUT, cm}/\Delta V_{OUT, dm}$ ; $\Delta V_{OUT, dm} = 1\text{ V}$ ; 10 MHz; see Figure 47 for test circuit		-61		dB

# ADA4937-1/ADA4937-2

## $V_{OCM}$ to $\pm OUT$ Performance

Table 2.

Parameter	Conditions	Min	Typ	Max	Unit
$V_{OCM}$ DYNAMIC PERFORMANCE					
–3 dB Bandwidth			440		MHz
Slew Rate	$V_{IN} = 1.5\text{ V to }3.5\text{ V}; 25\% \text{ to } 75\%$		1150		V/ $\mu$ s
Input Voltage Noise (RTI)	$f = 100\text{ kHz}$		7.5		nV/ $\sqrt{\text{Hz}}$
$V_{OCM}$ INPUT CHARACTERISTICS					
Input Voltage Range		1.2		3.8	V
Input Resistance		8	10	12	k $\Omega$
Input Offset Voltage	$V_{OS,cm} = V_{OUT,cm}; V_{DIN+} = V_{DIN-} = +V_S/2$		2	7.1	mV
Input Bias Current			0.5		$\mu$ A
$V_{OCM}$ CMRR	$\Delta V_{OUT,dm}/\Delta V_{OCM}; \Delta V_{OCM} = \pm 1\text{ V}$	–70	–75		dB
Gain	$\Delta V_{OUT,cm}/\Delta V_{OCM}; \Delta V_{OCM} = \pm 1\text{ V}$	0.97	0.98	1.00	V/V
POWER SUPPLY					
Operating Range		3.0		5.25	V
Quiescent Current per Amplifier	$T_{MIN}$ to $T_{MAX}$ variation	38.0	39.5	42.0	mA
	Powered down	0.02	0.3	0.5	mA
Power Supply Rejection Ratio	$\Delta V_{OUT,dm}/\Delta V_S; \Delta V_S = 1\text{ V}$	–70	–90		dB
POWER-DOWN (PD)					
$\overline{\text{PD}}$ Input Voltage	Powered down		$\leq 1$		V
	Enabled		$\geq 2$		V
Turn-Off Time			1		$\mu$ s
Turn-On Time			200		ns
$\overline{\text{PD}}$ Bias Current per Amplifier					
Enabled	$\overline{\text{PD}} = 5\text{ V}$	10	30	50	$\mu$ A
Disabled	$\overline{\text{PD}} = 0\text{ V}$	–300	–200	–150	$\mu$ A
OPERATING TEMPERATURE RANGE					
		–40		+85	$^{\circ}\text{C}$

### 3.3 V OPERATION

$T_A = 25^\circ\text{C}$ ,  $+V_S = 3.3\text{ V}$ ,  $-V_S = 0\text{ V}$ ,  $V_{\text{OCM}} = +V_S/2$ ,  $R_T = 61.9\ \Omega$ ,  $R_G = R_F = 200\ \Omega$ ,  $G = 1$ ,  $R_{L, \text{dm}} = 1\ \text{k}\Omega$ , unless otherwise noted. All specifications refer to single-ended input and differential outputs, unless otherwise noted.

#### $\pm D_{\text{IN}}$ to $\pm \text{OUT}$ Performance

Table 3.

Parameter	Conditions	Min	Typ	Max	Unit
<b>DYNAMIC PERFORMANCE</b>					
-3 dB Small Signal Bandwidth	$V_{\text{OUT, dm}} = 0.1\text{ V p-p}$		1800		MHz
Bandwidth for 0.1 dB Flatness	$V_{\text{OUT, dm}} = 0.1\text{ V p-p}$		200		MHz
Large Signal Bandwidth	$V_{\text{OUT, dm}} = 2\text{ V p-p}$		1300		MHz
Slew Rate	$V_{\text{OUT, dm}} = 2\text{ V p-p}$ ; 25% to 75%		4000		V/ $\mu\text{s}$
Overdrive Recovery Time	$V_{\text{IN}} = 0\text{ V}$ to 1.0 V step; $G = 3.16$		<1		ns
<b>NOISE/HARMONIC PERFORMANCE</b>					
See Figure 48 for distortion test circuit					
Second Harmonic	$V_{\text{OUT, dm}} = 2\text{ V p-p}$ ; 10 MHz		-113		dBc
	$V_{\text{OUT, dm}} = 2\text{ V p-p}$ ; 70 MHz		-85		dBc
	$V_{\text{OUT, dm}} = 2\text{ V p-p}$ ; 100 MHz		-77		dBc
Third Harmonic	$V_{\text{OUT, dm}} = 2\text{ V p-p}$ ; 10 MHz		-95		dBc
	$V_{\text{OUT, dm}} = 2\text{ V p-p}$ ; 70 MHz		-77		dBc
	$V_{\text{OUT, dm}} = 2\text{ V p-p}$ ; 100 MHz		-71		dBc
IMD	$f_1 = 70\text{ MHz}$ ; $f_2 = 70.1\text{ MHz}$ ; $V_{\text{OUT, dm}} = 2\text{ V p-p}$		-87		dBc
Voltage Noise (RTI)	$f = 100\text{ kHz}$		2.2		nV/ $\sqrt{\text{Hz}}$
Input Current Noise	$f = 100\text{ kHz}$		4		pA/ $\sqrt{\text{Hz}}$
Noise Figure	$G = 4$ ; $R_T = 136\ \Omega$ ; $R_F = 200\ \Omega$ ; $R_G = 37\ \Omega$ ; $f = 100\text{ MHz}$		15		dB
Crosstalk (ADA4937-2)	$f = 100\text{ MHz}$		-72		dB
<b>INPUT CHARACTERISTICS</b>					
Offset Voltage	$V_{\text{OS, dm}} = V_{\text{OUT, dm}}/2$ ; $V_{\text{DIN+}} = V_{\text{DIN-}} = +V_S/2$	-2.5	$\pm 0.5$	+2.5	mV
	$T_{\text{MIN}}$ to $T_{\text{MAX}}$ variation		$\pm 1$		$\mu\text{V}/^\circ\text{C}$
Input Bias Current	$T_{\text{MIN}}$ to $T_{\text{MAX}}$ variation	-50	-20	-10	$\mu\text{A}$
	Differential		0.01		$\mu\text{A}/^\circ\text{C}$
Input Resistance	Differential		6		M $\Omega$
	Common mode		3		M $\Omega$
Input Capacitance			1		pF
Input Common-Mode Voltage			0.3 to 1.2		V
CMRR	$\Delta V_{\text{OUT, dm}}/\Delta V_{\text{IN, cm}}$ ; $\Delta V_{\text{IN, cm}} = \pm 1\text{ V}$	-67	-80		dB
<b>OUTPUT CHARACTERISTICS</b>					
Output Voltage Swing	Maximum $\Delta V_{\text{OUT}}$ ; single-ended output; $R_F = R_G = 10\ \text{k}\Omega$	0.8		2.5	V
Linear Output Current			95		mA
Output Balance Error	$\Delta V_{\text{OUT, cm}}/\Delta V_{\text{OUT, dm}}$ ; $\Delta V_{\text{OUT, dm}} = 1\text{ V}$ ; $f = 10\text{ MHz}$ ; see Figure 47 for test circuit		-61		dB

# ADA4937-1/ADA4937-2

## $V_{OCM}$ to $\pm OUT$ Performance

Table 4.

Parameter	Conditions	Min	Typ	Max	Unit
$V_{OCM}$ DYNAMIC PERFORMANCE					
–3 dB Bandwidth			440		MHz
Slew Rate	$V_{IN} = 0.9\text{ V to } 2.4\text{ V}; 25\% \text{ to } 75\%$		900		V/ $\mu\text{s}$
Input Voltage Noise (RTI)	$f = 100\text{ kHz}$		7.5		nV/ $\sqrt{\text{Hz}}$
$V_{OCM}$ INPUT CHARACTERISTICS					
Input Voltage Range		1.2		2.1	V
Input Resistance			10		k $\Omega$
Input Offset Voltage	$V_{OS,cm} = V_{OUT,cm}; V_{DIN+} = V_{DIN-} = 1.67\text{ V}$		2	7.1	mV
Input Bias Current			0.5		$\mu\text{A}$
$V_{OCM}$ CMRR	$\Delta V_{OUT,dm}/\Delta V_{OCM}; \Delta V_{OCM} = \pm 1\text{ V}$	–70	–75		dB
Gain	$\Delta V_{OUT,cm}/\Delta V_{OCM}; \Delta V_{OCM} = \pm 1\text{ V}$	0.97	0.98	1.00	V/V
POWER SUPPLY					
Operating Range		3.0		5.25	V
Quiescent Current per Amplifier	$T_{MIN}$ to $T_{MAX}$ variation	36	38	40	mA
	Powered down	0.02	0.2	0.5	mA
Power Supply Rejection Ratio	$\Delta V_{OUT,dm}/\Delta V_S; \Delta V_S = 1\text{ V}$	–70	–90		dB
POWER-DOWN (PD)					
$\overline{\text{PD}}$ Input Voltage	Powered down		$\leq 1$		V
	Enabled		$\geq 2$		V
Turn-Off Time			1		$\mu\text{s}$
Turn-On Time			200		ns
$\overline{\text{PD}}$ Bias Current per Amplifier					
Enabled	$\overline{\text{PD}} = 3.3\text{ V}$	10	20	30	$\mu\text{A}$
Disabled	$\overline{\text{PD}} = 0\text{ V}$	–200	–120	–100	$\mu\text{A}$
OPERATING TEMPERATURE RANGE					
		–40		+105	$^{\circ}\text{C}$

## ABSOLUTE MAXIMUM RATINGS

Table 5.

Parameter	Rating
Supply Voltage	5.5 V
Power Dissipation	See Figure 4
Storage Temperature Range	-65°C to +125°C
Operating Temperature Range	
ADA4937-1	-40°C to +105°C
ADA4937-2	-40°C to +85°C
Lead Temperature (Soldering, 10 sec)	300°C
Junction Temperature	150°C

Stresses above those listed under Absolute Maximum Ratings may cause permanent damage to the device. This is a stress rating only; functional operation of the device at these or any other conditions above those indicated in the operational section of this specification is not implied. Exposure to absolute maximum rating conditions for extended periods may affect device reliability.

### THERMAL RESISTANCE

$\theta_{JA}$  is specified for the device (including exposed pad) soldered to a high thermal conductivity 2s2p circuit board, as described in EIA/JESD 51-7.

Table 6. Thermal Resistance

Package Type	$\theta_{JA}$	Unit
16-Lead LFCSP (Exposed Pad)	95	°C/W
24-Lead LFCSP (Exposed Pad)	67	°C/W

### Maximum Power Dissipation

The maximum safe power dissipation in the ADA4937 package is limited by the associated rise in junction temperature ( $T_J$ ) on the die. At approximately 150°C, which is the glass transition temperature, the plastic changes its properties. Even temporarily exceeding this temperature limit can change the stresses that the package exerts on the die, permanently shifting the parametric performance of the ADA4937. Exceeding a junction temperature of 150°C for an extended period can result in changes in the silicon devices, potentially causing failure.

The power dissipated in the package ( $P_D$ ) is the sum of the quiescent power dissipation and the power dissipated in the package due to the load drive. The quiescent power is the voltage between the supply pins ( $V_S$ ) times the quiescent current ( $I_S$ ). The power dissipated due to the load drive depends upon the particular application. The power due to load drive is calculated by multiplying the load current by the associated voltage drop across the device. RMS voltages and currents must be used in these calculations.

Airflow increases heat dissipation, effectively reducing  $\theta_{JA}$ . In addition, more metal directly in contact with the package leads/exposed pad from metal traces, through holes, ground, and power planes reduces  $\theta_{JA}$ .

Figure 4 shows the maximum safe power dissipation in the package vs. the ambient temperature for the single 16-lead LFCSP (95°C/W) and the dual 24-lead LFCSP (67°C/W) on a JEDEC standard 4-layer board.

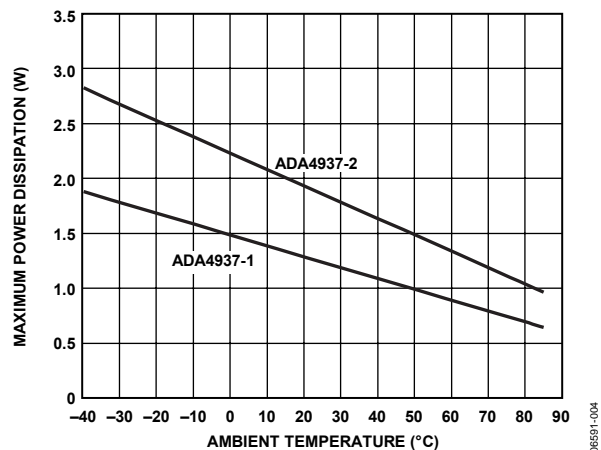

Figure 4. Maximum Power Dissipation vs. Temperature for a 4-Layer Board

### ESD CAUTION



**ESD (electrostatic discharge) sensitive device.** Charged devices and circuit boards can discharge without detection. Although this product features patented or proprietary protection circuitry, damage may occur on devices subjected to high energy ESD. Therefore, proper ESD precautions should be taken to avoid performance degradation or loss of functionality.

# ADA4937-1/ADA4937-2

## PIN CONFIGURATION AND FUNCTION DESCRIPTIONS

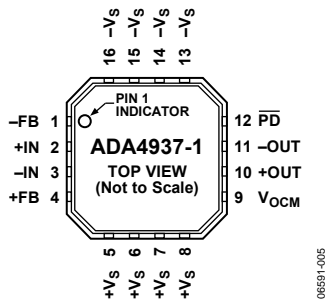

Figure 5. ADA4937-1 Pin Configuration

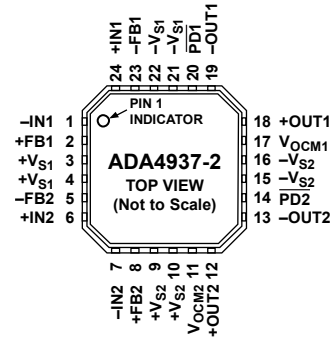

Figure 6. ADA4937-2 Pin Configuration

Table 7. ADA4937-1 Pin Function Descriptions

Pin No.	Mnemonic	Description
1	-FB	Negative Output for Feedback Component Connection.
2	+IN	Positive Input Summing Node.
3	-IN	Negative Input Summing Node.
4	+FB	Positive Output for Feedback Component Connection.
5 to 8	+V <sub>S</sub>	Positive Supply Voltage.
9	V <sub>OCM</sub>	Output Common-Mode Voltage.
10	+OUT	Positive Output for Load Connection.
11	-OUT	Negative Output for Load Connection.
12	PD	Power-Down Pin.
13 to 16	-V <sub>S</sub>	Negative Supply Voltage.

Table 8. ADA4937-2 Pin Function Descriptions

Pin No.	Mnemonic	Description
1	-IN1	Negative Input Summing Node 1.
2	+FB1	Positive Output Feedback Pin 1.
3, 4	+V <sub>S1</sub>	Positive Supply Voltage 1.
5	-FB2	Negative Output Feedback Pin 2.
6	+IN2	Positive Input Summing Node 2.
7	-IN2	Negative Input Summing Node 2.
8	+FB2	Positive Output Feedback Pin 2.
9, 10	+V <sub>S2</sub>	Positive Supply Voltage 2.
11	V <sub>OCM2</sub>	Output Common-Mode Voltage 2.
12	+OUT2	Positive Output 2.
13	-OUT2	Negative Output 2.
14	PD2	Power-Down Pin 2.
15, 16	-V <sub>S2</sub>	Negative Supply Voltage 2.
17	V <sub>OCM1</sub>	Output Common-Mode Voltage 1.
18	+OUT1	Positive Output 1.
19	-OUT1	Negative Output 1.
20	PD1	Power-Down Pin 1.
21, 22	-V <sub>S1</sub>	Negative Supply Voltage 1.
23	-FB1	Negative Output Feedback Pin 1.
24	+IN1	Positive Input Summing Node 1.



## TYPICAL PERFORMANCE CHARACTERISTICS

$T_A = 25^\circ\text{C}$ ,  $+V_S = 5\text{ V}$ ,  $-V_S = 0\text{ V}$ ,  $V_{OUT, dm} = 2\text{ V p-p}$ ,  $V_{OCM} = +V_S / 2$ ,  $R_T = 61.9\ \Omega$ ,  $R_G = R_F = 200\ \Omega$ ,  $G = 1$ ,  $R_{L, dm} = 1\text{ k}\Omega$ , unless otherwise noted. Refer to Figure 46 for test setup.

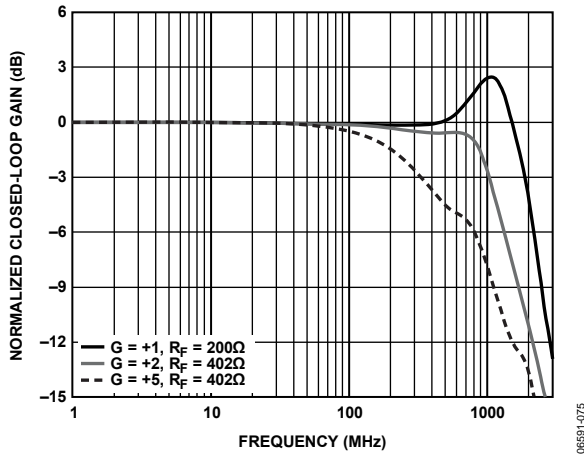

Figure 7. Small Signal Frequency Response for Various Gains,  $V_{OUT, dm} = 100\text{ mV p-p}$

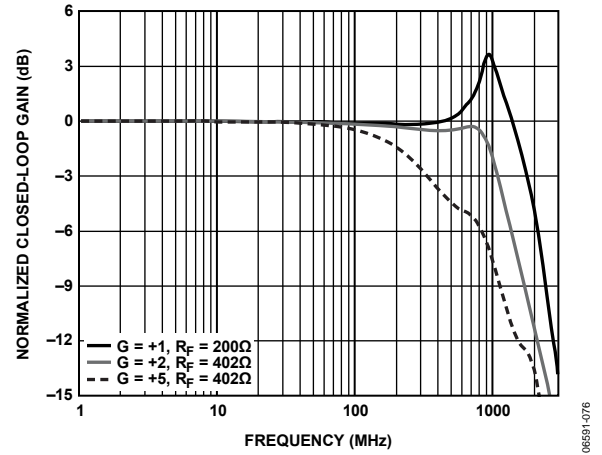

Figure 10. Large Signal Frequency Response for Various Gains

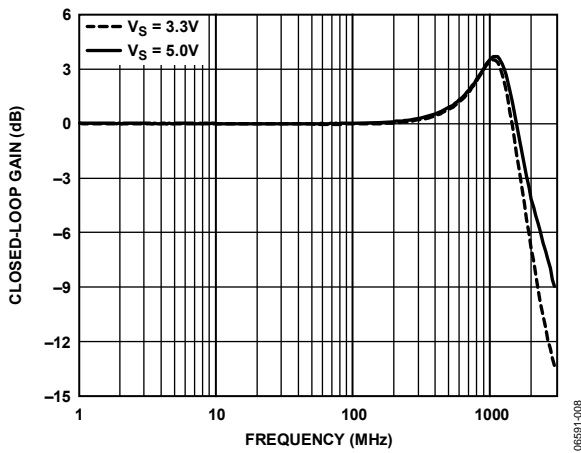

Figure 8. Small Signal Frequency Response for Various Supplies,  $V_{OUT, dm} = 100\text{ mV p-p}$

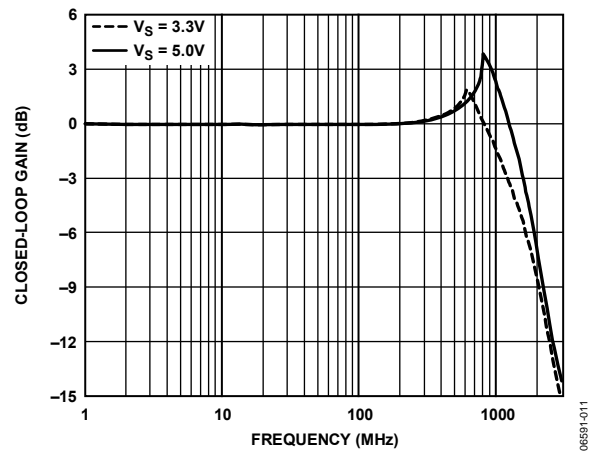

Figure 11. Large Signal Frequency Response for Various Supplies

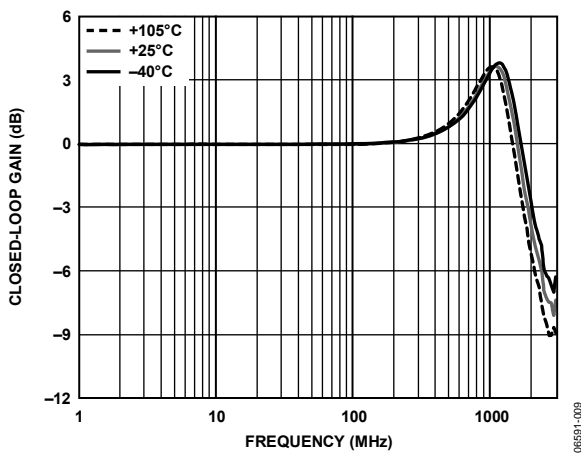

Figure 9. Small Signal Frequency Response for Various Temperatures,  $V_{OUT, dm} = 100\text{ mV p-p}$

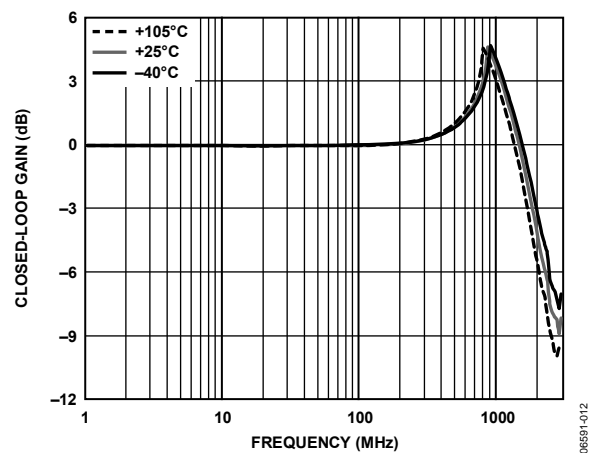

Figure 12. Large Signal Frequency Response for Various Temperatures

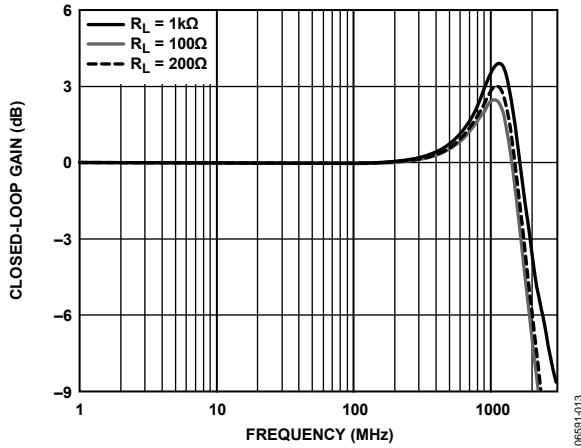

Figure 13. Small Signal Frequency Response for Various Loads,  $V_{OUT, dm} = 100 \text{ mV p-p}$

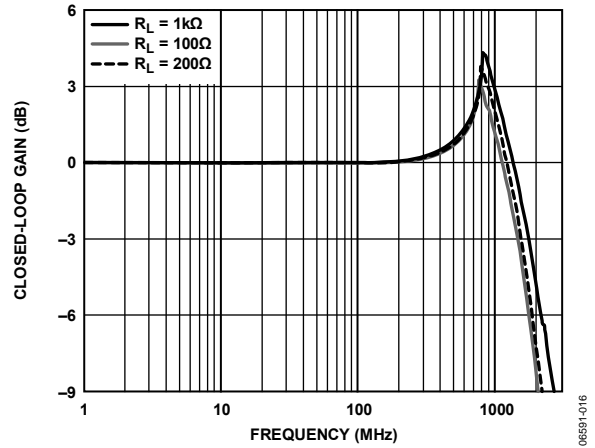

Figure 16. Large Signal Frequency Response for Various Loads

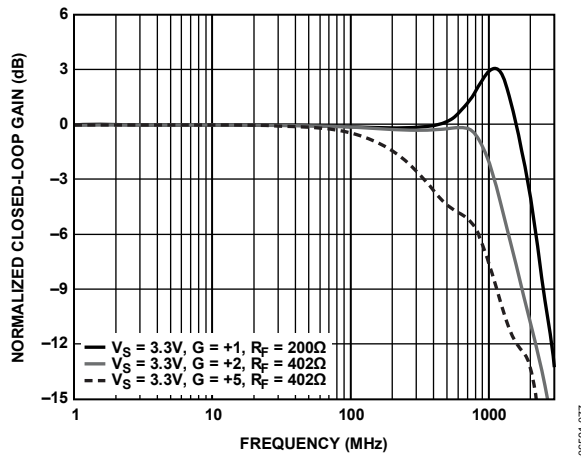

Figure 14. Small Signal Frequency Response for Various Gains,  $V_S = 3.3 \text{ V}$  and  $V_{OUT, dm} = 100 \text{ mV p-p}$

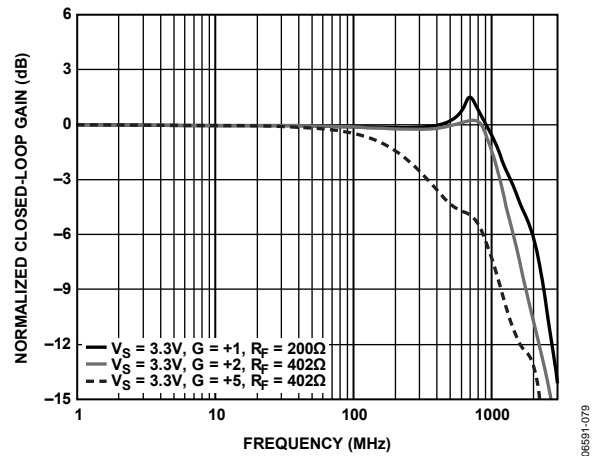

Figure 17. Large Signal Frequency Response for Various Gains,  $V_S = 3.3 \text{ V}$

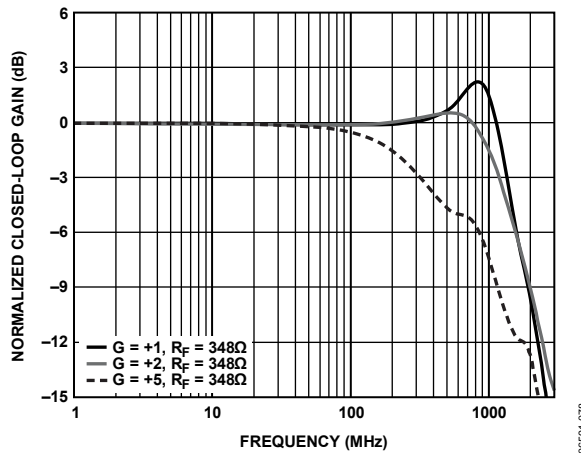

Figure 15. Small Signal Frequency Response for Various Gains,  $V_{OUT, dm} = 100 \text{ mV p-p}$ ,  $R_F = 348 \Omega$

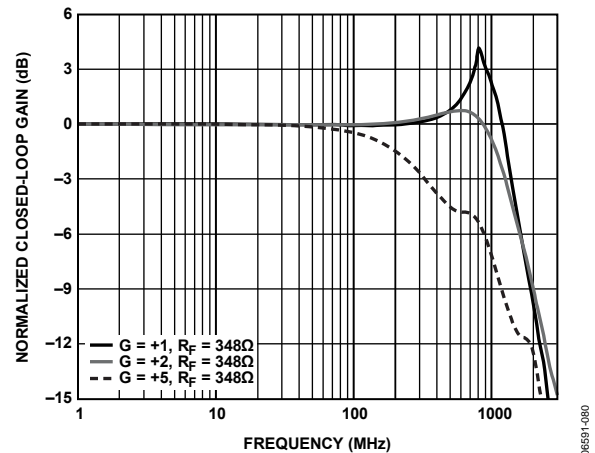

Figure 18. Large Signal Frequency Response for Various Gains,  $R_F = 348 \Omega$

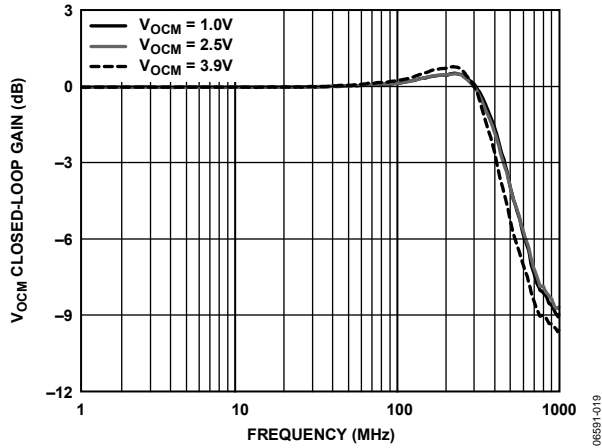

Figure 19. Small Signal Frequency Response for Various  $V_{OCM}$

06591-019

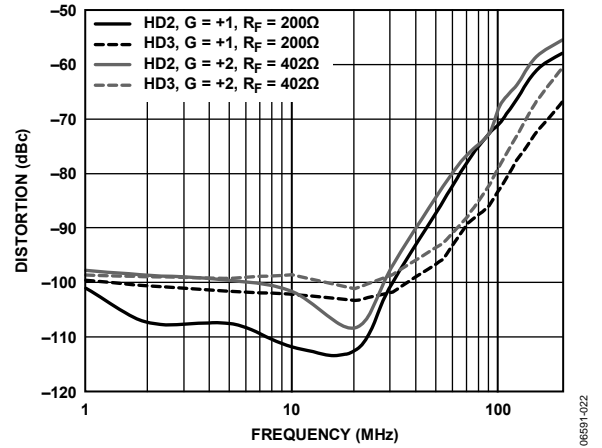

Figure 22. Harmonic Distortion vs. Frequency and Gain

06591-022

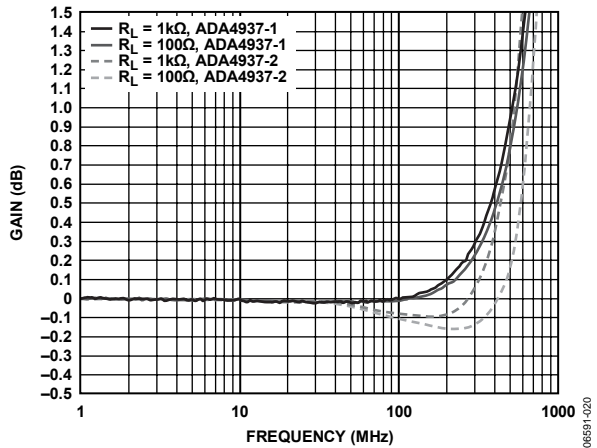

Figure 20. 0.1 dB Flatness Response for Various Loads

06591-020

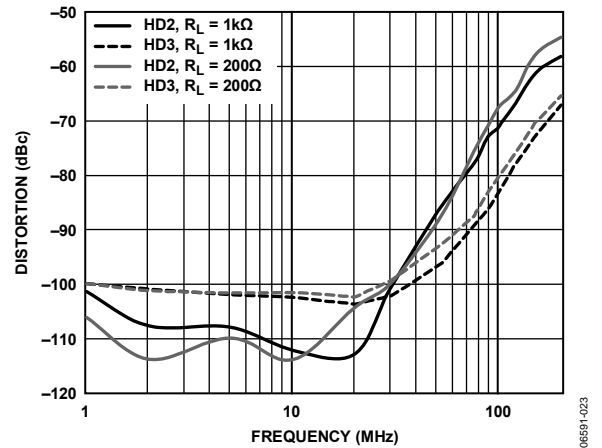

Figure 23. Harmonic Distortion vs. Frequency and Load

06591-023

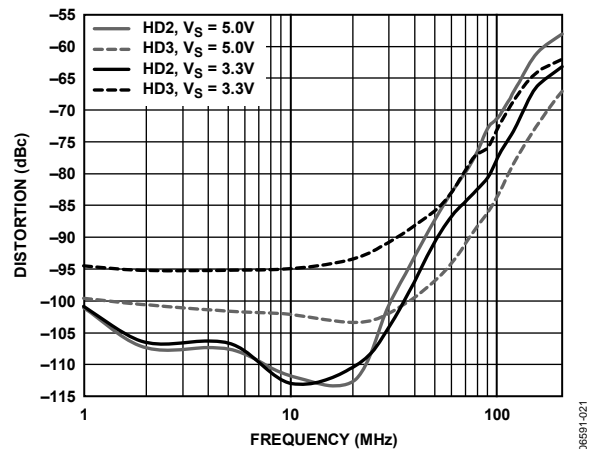

Figure 21. Harmonic Distortion vs. Frequency and Supply Voltage

06591-021

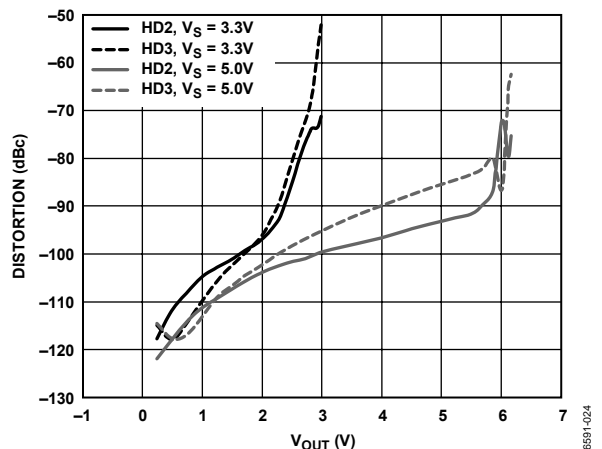

Figure 24. Harmonic Distortion vs.  $V_{OUT}$  and Supply Voltage

06591-024

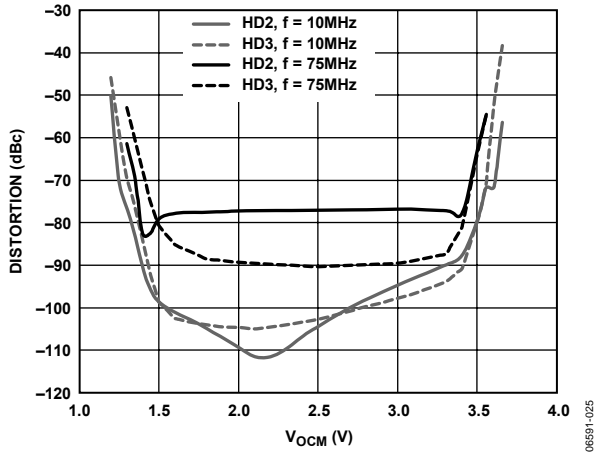

Figure 25. Harmonic Distortion vs.  $V_{OCM}$  and Frequency

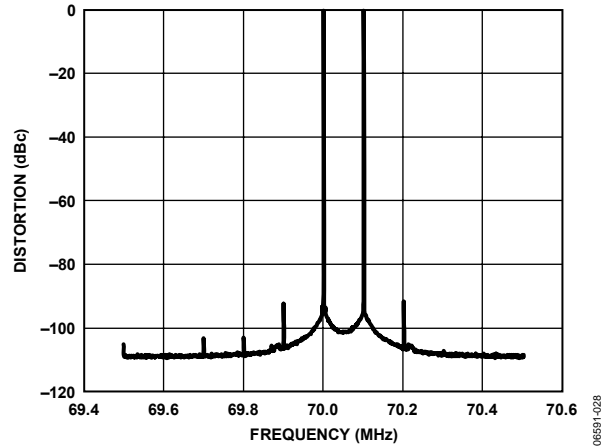

Figure 28. 70 MHz Intermodulation Distortion

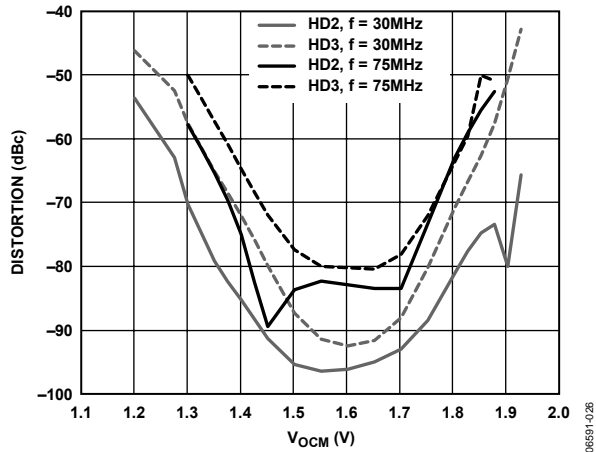

Figure 26. Harmonic Distortion vs.  $V_{OCM}$  and Frequency,  $V_S = 3.3 V$

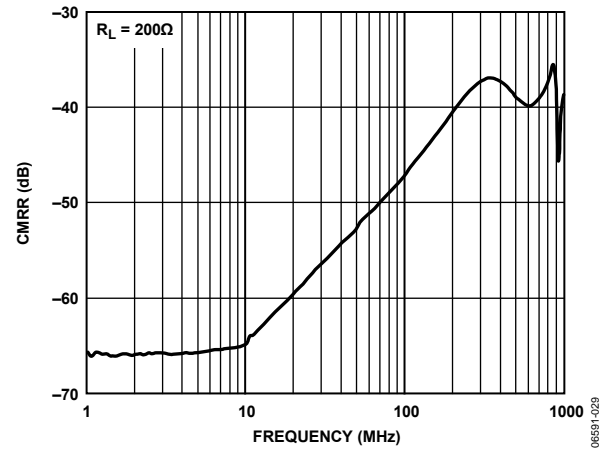

Figure 29. CMRR vs. Frequency

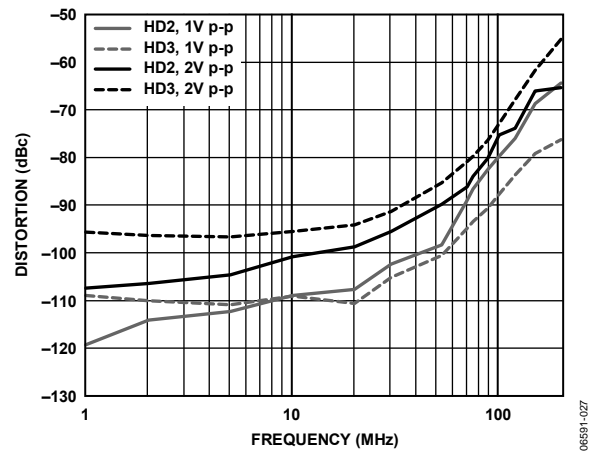

Figure 27. Harmonic Distortion vs. Frequency and  $V_{OUT}$ ,  $V_S = 3.3 V$

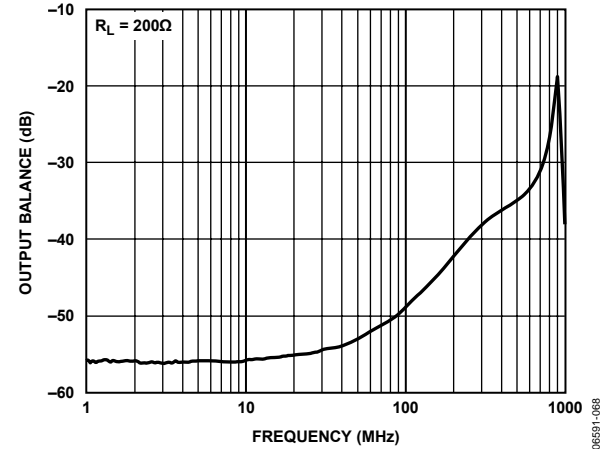

Figure 30. Output Balance vs. Frequency

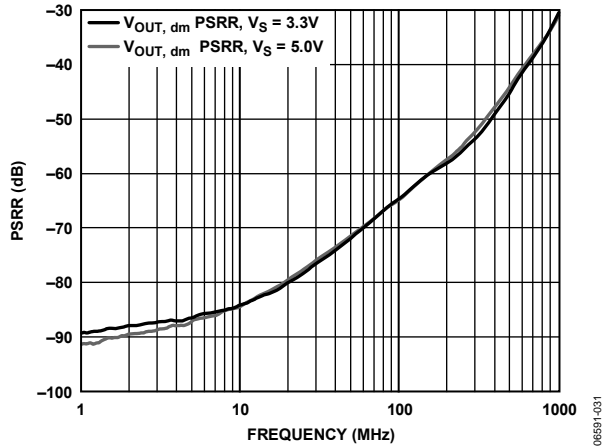

Figure 31. PSRR vs. Frequency,  $R_L = 200 \Omega$

06591-031

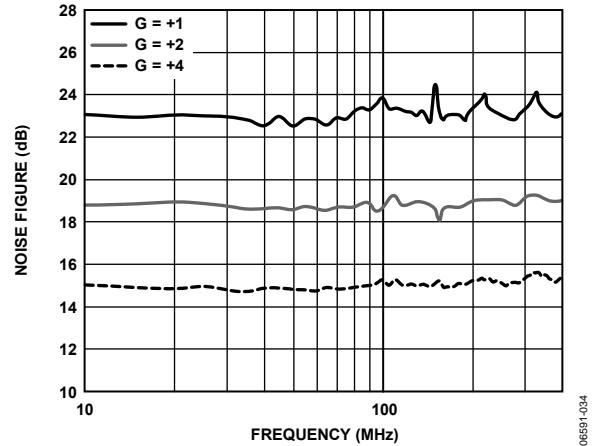

Figure 34. Noise Figure vs. Frequency

06591-034

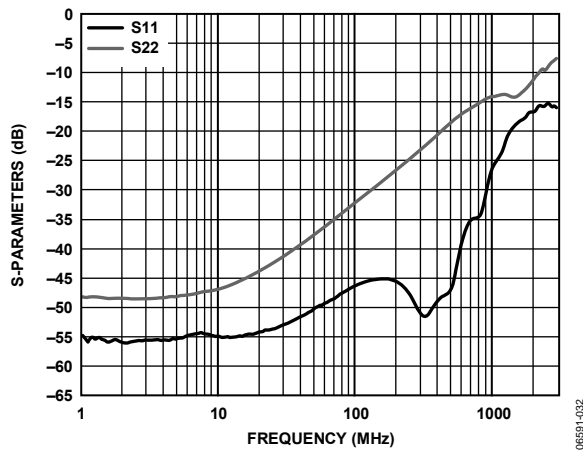

Figure 32. Return Loss ( $S_{11}$ ,  $S_{22}$ ) vs. Frequency

06591-032

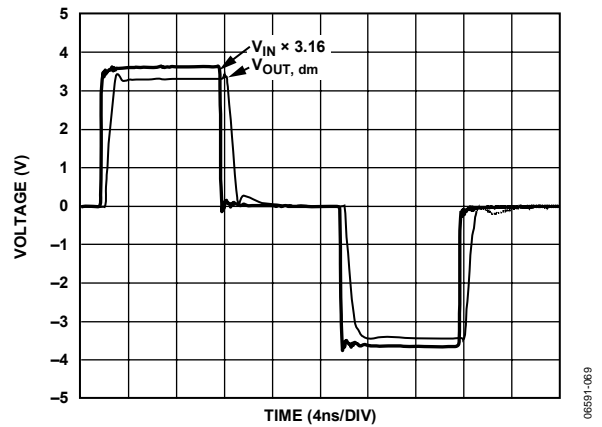

Figure 35. Overdrive Recovery Time (Pulse Input)

06591-039

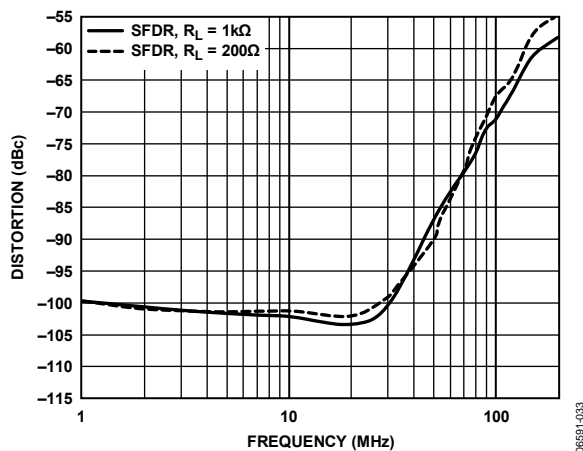

Figure 33. Spurious-Free Dynamic Range vs. Frequency and Load

06591-033

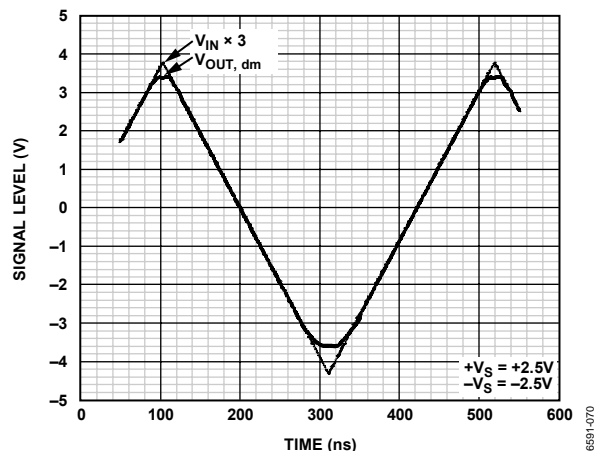

Figure 36. Overdrive Amplitude Characteristics (Triangle Wave Input)

06591-070

# ADA4937-1/ADA4937-2

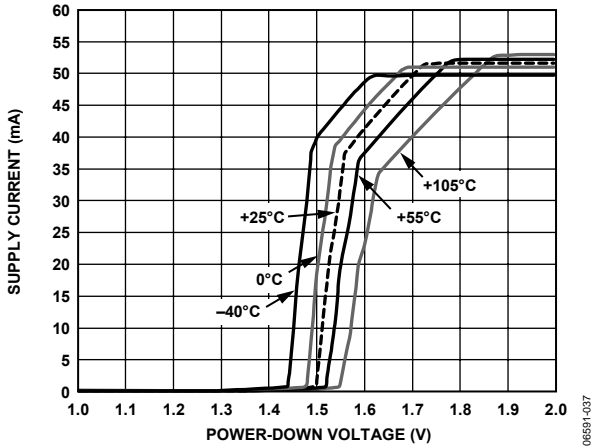

Figure 37. Supply Current vs.  $\overline{PD}$  for Various Temperatures

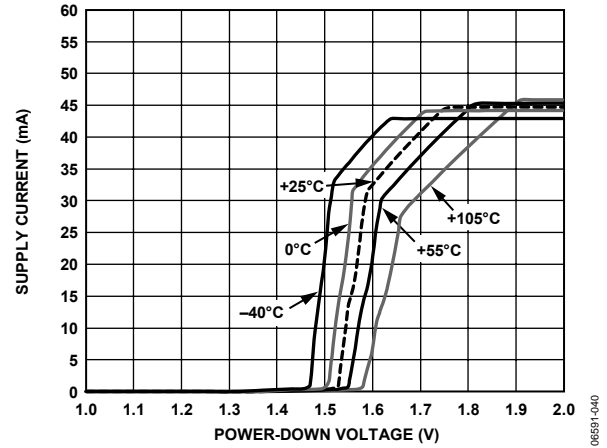

Figure 40. Supply Current vs.  $\overline{PD}$  for Various Temperatures,  $V_S = 3.3V$

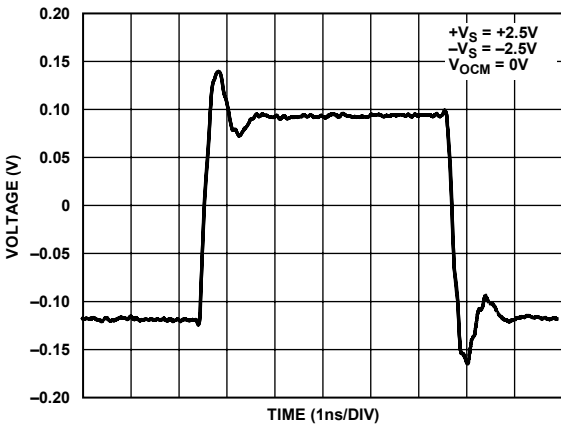

Figure 38. Small Signal Pulse Response

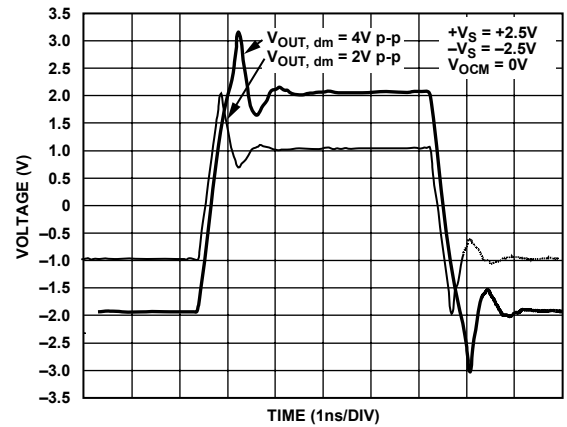

Figure 41. Large Signal Pulse Response

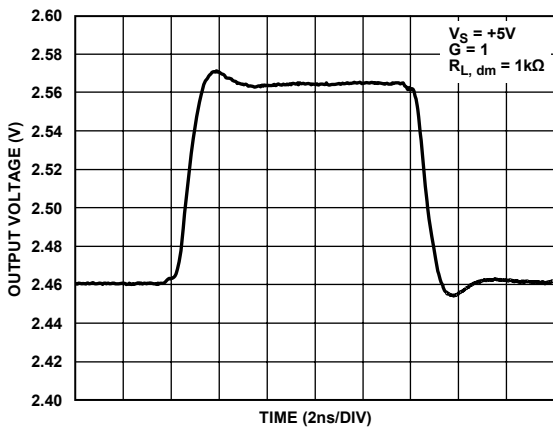

Figure 39. Small Signal  $V_{OCM}$  Pulse Response

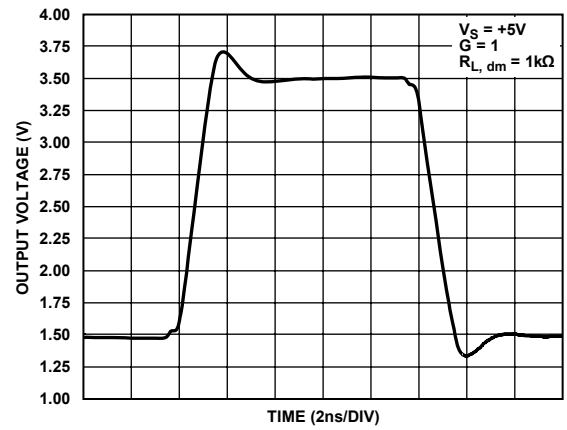

Figure 42. Large Signal  $V_{OCM}$  Pulse Response

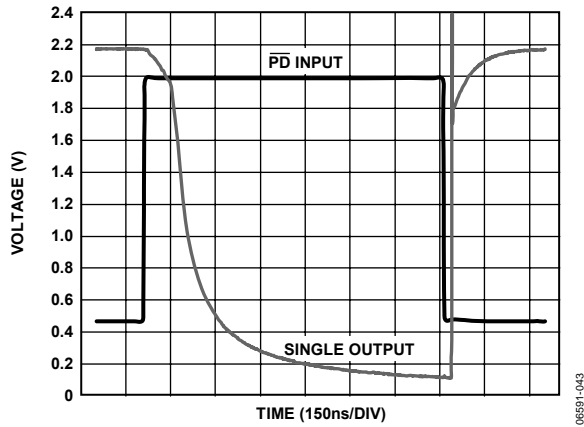

Figure 43.  $\overline{PD}$  Response vs. Time

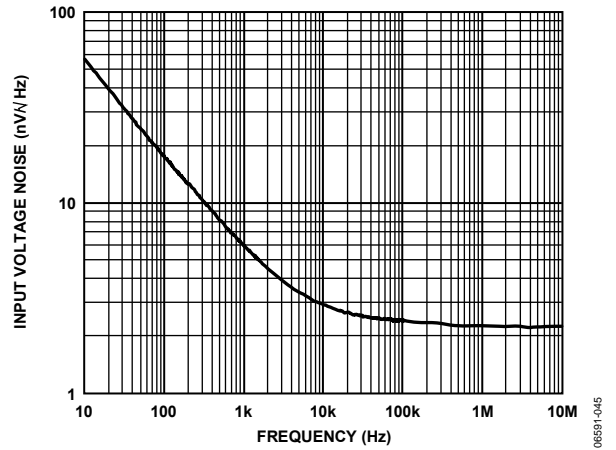

Figure 45. Voltage Spectral Noise Density, RTI

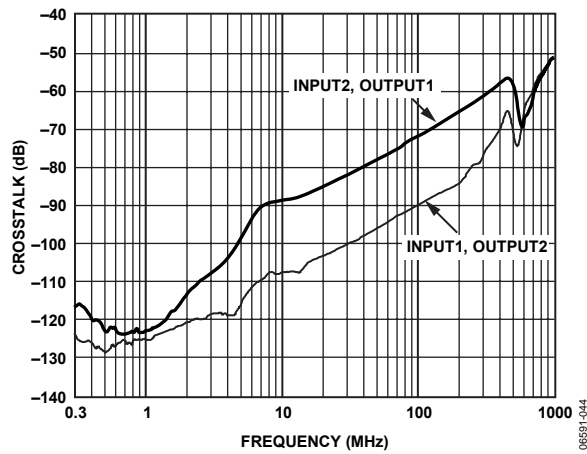

Figure 44. Crosstalk vs. Frequency for ADA4937-2

## TEST CIRCUITS

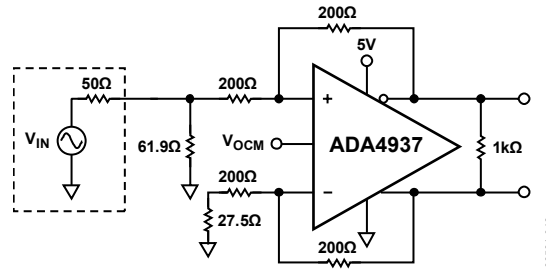

Figure 46. Equivalent Basic Test Circuit

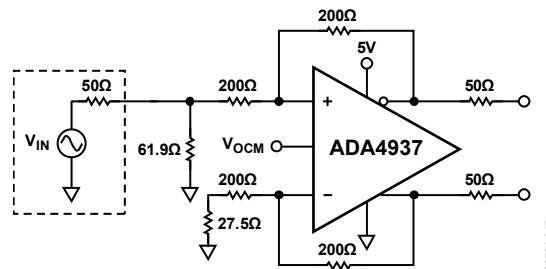

Figure 47. Test Circuit for Output Balance

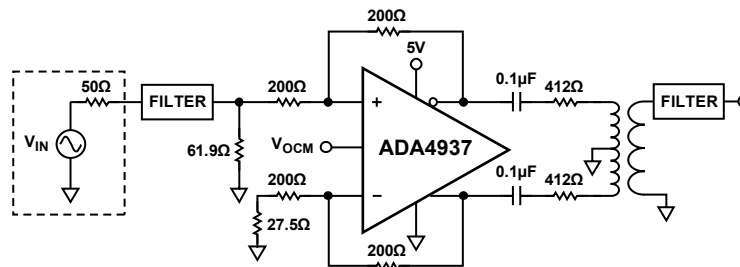

Figure 48. Test Circuit for Distortion Measurements



## OPERATIONAL DESCRIPTION

### DEFINITION OF TERMS

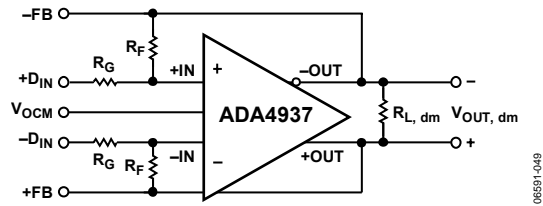

Figure 49. Circuit Definitions

### Differential Voltage

Differential voltage refers to the difference between two node voltages. For example, the output differential voltage (or equivalently, output differential-mode voltage) is defined as

$$V_{OUT, dm} = (V_{+OUT} - V_{-OUT})$$

where  $V_{+OUT}$  and  $V_{-OUT}$  refer to the voltages at the +OUT and -OUT terminals with respect to a common reference.

### Common-Mode Voltage

Common-mode voltage refers to the average of two node voltages. The output common-mode voltage is defined as

$$V_{OUT, cm} = (V_{+OUT} + V_{-OUT})/2$$

### Balance

Output balance is a measure of how close the differential signals are to being equal in amplitude and opposite in phase. Output balance is most easily determined by placing a well-matched resistor divider between the differential voltage nodes and comparing the magnitude of the signal at the divider's midpoint with the magnitude of the differential signal (see Figure 47). By this definition, output balance is the magnitude of the output common-mode voltage divided by the magnitude of the output differential mode voltage.

$$\text{Output Balance Error} = \left| \frac{V_{OUT, cm}}{V_{OUT, dm}} \right|$$

## THEORY OF OPERATION

The ADA4937 differs from conventional op amps in that it has two outputs whose voltages move in opposite directions. Like an op amp, it relies on open-loop gain and negative feedback to force these outputs to the desired voltages. The ADA4937 behaves much like a standard voltage feedback op amp, which makes it easier to perform single-ended-to-differential conversions, common-mode level shifting, and amplifications of differential signals. Also like an op amp, the ADA4937 has high input impedance and low output impedance.

Two feedback loops are employed to control the differential and common-mode output voltages. The differential feedback, set with external resistors, controls only the differential output voltage. The common-mode feedback controls only the common-mode output voltage. This architecture makes it easy to set the output common-mode level to any arbitrary value. It is forced, by internal common-mode feedback, to be equal to the voltage applied to the  $V_{OCM}$  input, without affecting the differential output voltage.

The ADA4937 architecture results in outputs that are highly balanced over a wide frequency range without requiring tightly matched external components. The common-mode feedback loop forces the signal component of the output common-mode voltage to zero. This results in nearly perfectly balanced differential outputs that are identical in amplitude and are exactly 180° apart in phase.

### ANALYZING AN APPLICATION CIRCUIT

The ADA4937 uses open-loop gain and negative feedback to force its differential and common-mode output voltages in such a way as to minimize the differential and common-mode error voltages. The differential error voltage is defined as the voltage between the differential inputs labeled +IN and -IN (see Figure 49). For most purposes, this voltage can be assumed to be zero. Similarly, the difference between the actual output common-mode voltage and the voltage applied to  $V_{OCM}$  can also be assumed to be zero. Starting from these two assumptions, any application circuit can be analyzed.

### SETTING THE CLOSED-LOOP GAIN

The differential-mode gain of the circuit in Figure 49 can be determined by

$$\left| \frac{V_{OUT, dm}}{V_{IN, dm}} \right| = \frac{R_F}{R_G}$$

This assumes that the input resistors ( $R_G$ ) and feedback resistors ( $R_F$ ) on each side are equal.

### ESTIMATING THE OUTPUT NOISE VOLTAGE

The differential output noise of the ADA4937 can be estimated using the noise model in Figure 50. The input-referred noise voltage density,  $v_{nIN}$ , is modeled as a differential input, and the noise currents,  $i_{nIN-}$  and  $i_{nIN+}$ , appear between each input and ground. The noise currents are assumed to be equal and produce a voltage across the parallel combination of the gain and feedback resistances.  $v_{nCM}$  is the noise voltage density at the  $V_{OCM}$  pin. Each of the four resistors contributes  $(4kTR_x)^{1/2}$ . Table 9 summarizes the input noise sources, the multiplication factors, and the output-referred noise density terms.

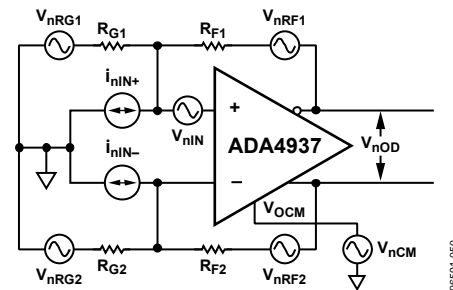

Figure 50. ADA4937 Noise Model

Table 9. Output Noise Voltage Density Calculations

Input Noise Contribution	Input Noise Term	Input Noise Voltage Density	Output Multiplication Factor	Output Noise Voltage Density Term
Differential Input	$v_{nIN}$	$v_{nIN}$	$G_N$	$v_{nO1} = G_N(v_{nIN})$
Inverting Input	$i_{nIN-}$	$i_{nIN-} \times (R_{G2}    R_{F2})$	$G_N$	$v_{nO2} = G_N[i_{nIN-} \times (R_{G2}    R_{F2})]$
Noninverting Input	$i_{nIN+}$	$i_{nIN+} \times (R_{G1}    R_{F1})$	$G_N$	$v_{nO3} = G_N[i_{nIN+} \times (R_{G1}    R_{F1})]$
$V_{OCM}$ Input	$v_{nCM}$	$v_{nCM}$	$G_N(\beta_1 - \beta_2)$	$v_{nO4} = G_N(\beta_1 - \beta_2)(v_{nCM})$
Gain Resistor $R_{G1}$	$v_{nRG1}$	$(4kTR_{G1})^{1/2}$	$G_N(1 - \beta_2)$	$v_{nO5} = G_N(1 - \beta_2)(4kTR_{G1})^{1/2}$
Gain Resistor $R_{G2}$	$v_{nRG2}$	$(4kTR_{G2})^{1/2}$	$G_N(1 - \beta_1)$	$v_{nO6} = G_N(1 - \beta_1)(4kTR_{G2})^{1/2}$
Feedback Resistor $R_{F1}$	$v_{nRF1}$	$(4kTR_{F1})^{1/2}$	1	$v_{nO7} = (4kTR_{F1})^{1/2}$
Feedback Resistor $R_{F2}$	$v_{nRF2}$	$(4kTR_{F2})^{1/2}$	1	$v_{nO8} = (4kTR_{F2})^{1/2}$

Similar to the case of a conventional op amp, the output noise voltage densities can be estimated by multiplying the input-referred terms at +IN and -IN by the appropriate output factor, where:

$$G_N = \frac{2}{(\beta_1 + \beta_2)}$$
 is the circuit noise gain.

$$\beta_1 = \frac{R_{G1}}{R_{F1} + R_{G1}} \text{ and } \beta_2 = \frac{R_{G2}}{R_{F2} + R_{G2}}$$
 are the feedback factors.

When  $R_{F1}/R_{G1} = R_{F2}/R_{G2}$ , then  $\beta_1 = \beta_2 = \beta$ , and the noise gain becomes

$$G_N = \frac{1}{\beta} = 1 + \frac{R_F}{R_G}$$

Note that the output noise from  $V_{OCM}$  goes to zero in this case. The total differential output noise density,  $v_{nOD}$ , is the root-sum-square of the individual output noise terms.

$$v_{nOD} = \sqrt{\sum_{i=1}^8 v_{nOi}^2}$$

## IMPACT OF MISMATCHES IN THE FEEDBACK NETWORKS

As previously mentioned, even if the external feedback networks ( $R_F/R_G$ ) are mismatched, the internal common-mode feedback loop still forces the outputs to remain balanced. The amplitudes of the signals at each output remain equal and 180° out of phase. The input-to-output differential mode gain varies proportionately to the feedback mismatch, but the output balance is unaffected.

As well as causing a noise contribution from  $V_{OCM}$ , ratio matching errors in the external resistors result in a degradation of the ability of the circuit to reject input common-mode signals, much the same as for a four-resistor difference amplifier made from a conventional op amp.

In addition, if the dc levels of the input and output common-mode voltages are different, matching errors result in a small differential-mode output offset voltage. When  $G = 1$ , with a ground referenced input signal and the output common-mode level set to 2.5 V, an output offset of as much as 25 mV (1% of the difference in common-mode levels) can result if 1% tolerance resistors are used. Resistors of 1% tolerance result in a worst-case input CMRR of about 40 dB, a worst-case differential-mode output offset of 25 mV due to 2.5 V level-shift, and no significant degradation in output balance error.

## CALCULATING THE INPUT IMPEDANCE FOR AN APPLICATION CIRCUIT

The effective input impedance of a circuit depends on whether the amplifier is being driven by a single-ended or differential signal source. For balanced differential input signals, as shown in Figure 51, the input impedance ( $R_{IN, dm}$ ) between the inputs (+D<sub>IN</sub> and -D<sub>IN</sub>) is simply  $R_{IN, dm} = 2 \times R_G$ .

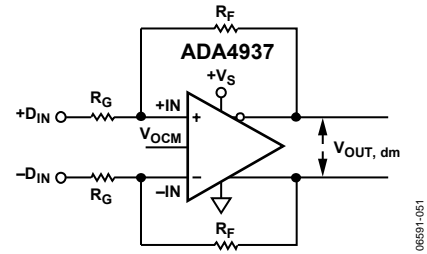

Figure 51. ADA4937 Configured for Balanced (Differential) Inputs

For an unbalanced, single-ended input signal (see Figure 52), the input impedance is

$$R_{IN, cm} = \left( \frac{R_G}{1 - \frac{R_F}{2 \times (R_G + R_F)}} \right)$$

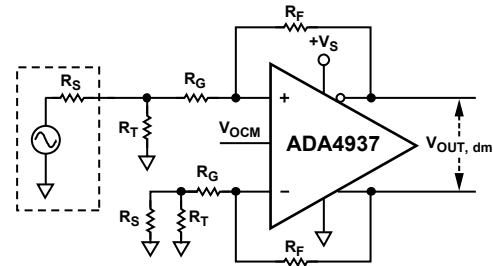

Figure 52. ADA4937 Configured for Unbalanced (Single-Ended) Input

The input impedance of the circuit is effectively higher than it would be for a conventional op amp connected as an inverter because a fraction of the differential output voltage appears at the inputs as a common-mode signal, partially bootstrapping the voltage across the input resistor  $R_G$ .

### Terminating a Single-Ended Input

This section deals with how to properly terminate a single-ended input to the ADA4937. Using a simple example with an input source of 2 V and a source resistor of 50 Ω, four simple steps must be followed.

1. The input impedance must be calculated using the formula

$$R_{IN} = \left( \frac{R_G}{1 - \frac{R_F}{2 \times (R_G + R_F)}} \right) = \left( \frac{200}{1 - \frac{200}{2 \times (200 + 200)}} \right) = 267 \Omega$$

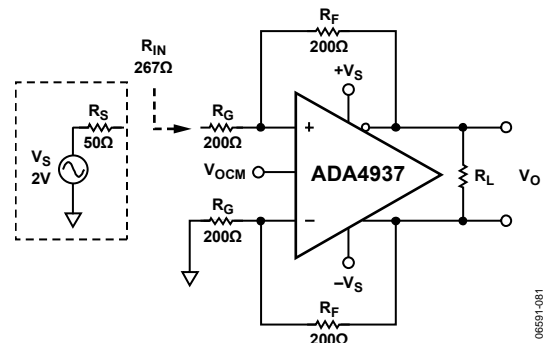

Figure 53. Single-Ended Input Impedance  $R_{IN}$

# ADA4937-1/ADA4937-2

2. In order for the source termination to be 50 Ω, the termination resistor ( $R_T$ ) is calculated using  $R_T || R_{IN} = 50 \Omega$ , which makes  $R_T$  equal to 61.9 Ω.

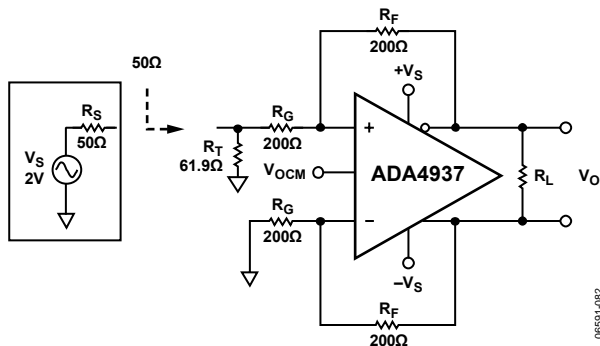

Figure 54. Adding Termination Resistor  $R_T$

3. To compensate for the imbalance of the gain resistors, a correction resistor ( $R_{TS}$ ) is added in series with the inverting input gain resistor  $R_G$ .  $R_{TS}$  is equal to the Thevenin equivalent of the source resistance  $R_S || R_T$ .

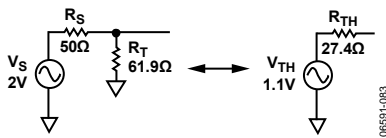

Figure 55. Calculating Thevenin Equivalent

$R_{TS} = R_{TH} = R_S || R_T = 27.4 \Omega$ . Note that  $V_{TH}$  is not equal to  $V_S/2$ , which would be the case if the termination were not affected by the amplifier circuit.

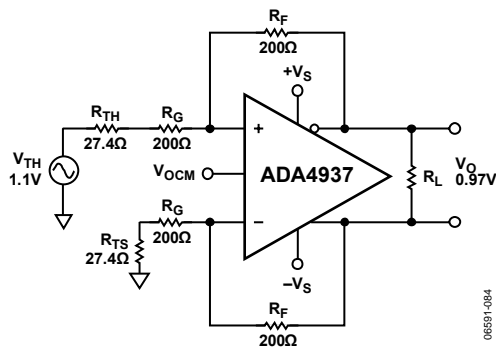

Figure 56. Balancing Gain Resistor  $R_G$

4. The feedback resistor is calculated to adjust the output voltage.
- a. To make the output voltage  $V_{OUT} = 1 \text{ V}$ ,  $R_F$  must be calculated using the following formula:

$$R_F = \left( \frac{V_{OUT} \times (R_G + R_{TS})}{V_{TH}} \right) = \left( \frac{1 \times (200 + 27.4)}{1.1} \right) = 207 \Omega$$

- b. To make  $V_O = V_S = 2 \text{ V}$  to recover the loss due to the input termination,  $R_F$  should be

$$R_F = \left( \frac{V_{OUT} \times (R_G + R_{TS})}{V_{TH}} \right) = \left( \frac{2 \times (200 + 27.4)}{1.1} \right) = 414 \Omega$$

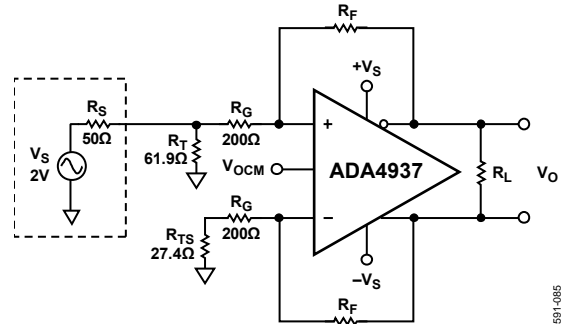

Figure 57. Complete Single-Ended-to-Differential System

## INPUT COMMON-MODE VOLTAGE RANGE IN SINGLE-SUPPLY APPLICATIONS

The ADA4937 is optimized for level-shifting ground-referenced input signals. As such, the center of the input common-mode range is shifted approximately 1 V down from midsupply. For 5 V single-supply operation, the input common-mode range at the summing nodes of the amplifier is 0.3 V to 3.0 V, and 0.3 V to 1.9 V with a 3.3 V supply. To avoid clipping at the outputs, the voltage swing at the +IN and -IN terminals must be confined to these ranges.

## SETTING THE OUTPUT COMMON-MODE VOLTAGE

The  $V_{OCM}$  pin of the ADA4937 is internally biased at a voltage approximately equal to the midsupply point,  $[(+V_S) + (-V_S)]/2$ . Relying on this internal bias results in an output common-mode voltage that is within about 100 mV of the expected value.

In cases where more accurate control of the output common-mode level is required, it is recommended that an external source, or resistor divider (10 kΩ or greater resistors), be used. The output common-mode offset listed in the Specifications section assumes that the  $V_{OCM}$  input is driven by a low impedance voltage source.

It is also possible to connect the  $V_{OCM}$  input to a common-mode level (CML) output of an ADC. However, care must be taken to ensure that the output has sufficient drive capability. The input impedance of the  $V_{OCM}$  pin is approximately 10 kΩ. If multiple ADA4937 devices share one reference output, it is recommended that a buffer be used.

Table 10 and Table 11 list several common gain settings, associated resistor values, input impedance and output noise density for both balanced and unbalanced input configurations.

**Table 10. Differential Ground-Referenced Input, DC-Coupled, 1 kΩ Load; See Figure 51**

Nominal Gain (dB)	R <sub>F</sub> (Ω)	R <sub>G</sub> (Ω)	R <sub>IN, dm</sub> (Ω)	Differential Output Noise Density (nV/√Hz)
0	200	200	400	5.8
6	402	200	400	9.6
10	402	127	254	12.1
14	402	80.6	161	16.2

**Table 11. Single-Ended Ground-Referenced Input, DC-Coupled, R<sub>S</sub> = 50 Ω, R<sub>L</sub> = 1 kΩ; See Figure 52**

Nominal Gain (dB)	R <sub>F</sub> (Ω)	R <sub>G1</sub> (Ω)	R <sub>T</sub> (Ω)	R <sub>IN, cm</sub> (Ω)	R <sub>G2</sub> (Ω) <sup>1</sup>	Differential Output Noise Density (nV/√Hz)
0	200	200	61.9	267	226	5.5
6	402	200	60.4	301	228	8.6
10	402	127	66.5	205	155	10.1
14	402	80.6	76.8	138	111	12.2

<sup>1</sup> R<sub>G2</sub> = R<sub>G1</sub> + (R<sub>S</sub>||R<sub>T</sub>)

## LAYOUT, GROUNDING, AND BYPASSING

As a high speed device, the ADA4937 is sensitive to the PCB environment in which it operates. Realizing its superior performance requires attention to the details of high speed PCB design. This section shows a detailed example of how the ADA4937-1 was addressed.

The first requirement is a solid ground plane that covers as much of the board area around the ADA4937-1 as possible. However, the area near the feedback resistors ( $R_F$ ), gain resistors ( $R_G$ ), and the input summing nodes (Pin 2 and Pin 3) should be cleared of all ground and power planes (see Figure 58). Clearing the ground and power planes minimizes any stray capacitance at these nodes and prevents peaking of the response of the amplifier at high frequencies.

The thermal resistance,  $\theta_{JA}$ , is specified for the device, including the exposed pad, soldered to a high thermal conductivity 4-layer circuit board, as described in EIA/JESD 51-7.

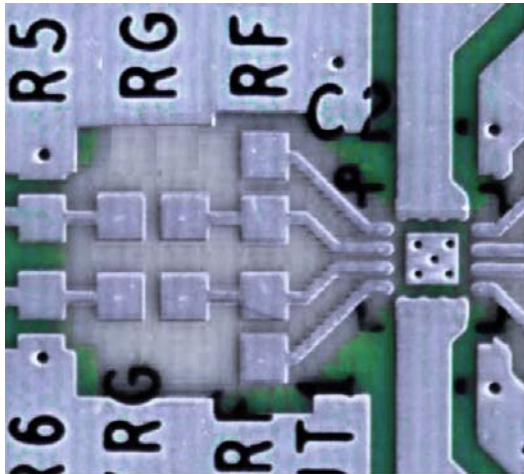

Figure 58. Ground and Power Plane Voiding in Vicinity of  $R_F$  and  $R_G$

The power supply pins should be bypassed as close to the device as possible and directly to a nearby ground plane. High frequency ceramic chip capacitors should be used. It is recommended that two parallel bypass capacitors (1000 pF and 0.1  $\mu$ F) be used for each supply. The 1000 pF capacitor should be placed closer to the device. Further away, low frequency bypassing should be provided, using 10  $\mu$ F tantalum capacitors from each supply to ground.

Signal routing should be short and direct to avoid parasitic effects. Wherever complementary signals exist, a symmetrical layout should be provided to maximize balanced performance. When routing differential signals over a long distance, PCB traces should be close together, and any differential wiring should be twisted such that loop area is minimized. Doing this reduces radiated energy and makes the circuit less susceptible to interference.

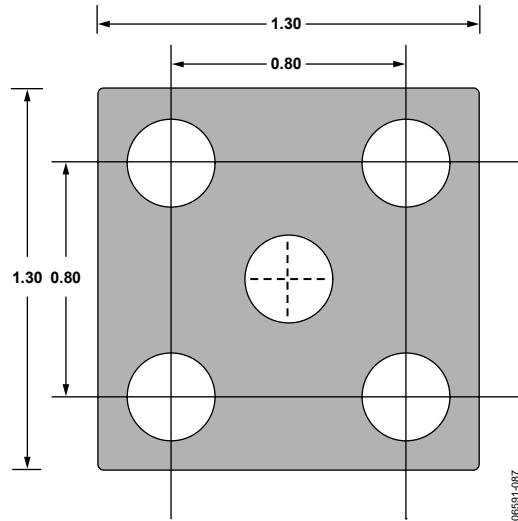

Figure 59. Recommended PCB Thermal Attach Pad Dimensions (Millimeters)

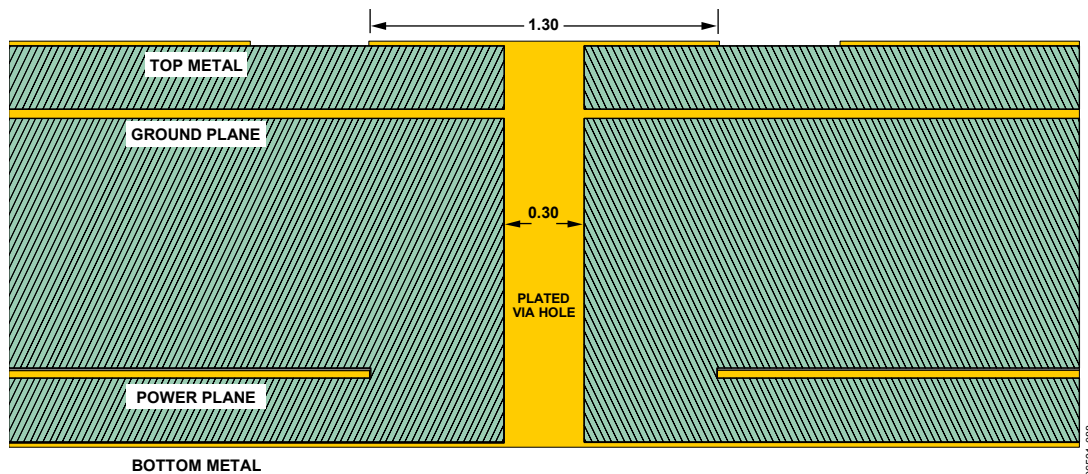

Figure 60. Cross-Section of 4-Layer PCB Showing Thermal Via Connection to Buried Ground Plane (Dimensions in Millimeters)

## HIGH PERFORMANCE ADC DRIVING

The ADA4937 is ideally suited for broadband IF applications. The circuit in Figure 61 shows a front-end connection for an ADA4937 driving an AD9445, 14-bit, 105 MSPS ADC. The AD9445 achieves its optimum performance when driven differentially. The ADA4937 eliminates the need for a transformer to drive the ADC and performs a single-ended-to-differential conversion and buffering of the driving signal.

The ADA4937 is configured with a single 5 V supply and unity gain for a single-ended input to differential output. The 61.9 Ω termination resistor, in parallel with the single-ended input impedance of 267 Ω, provides a 50 Ω termination for the source. The additional 26 Ω (226 Ω total) at the inverting input balances the parallel impedance of the 50 Ω source and the termination resistor driving the noninverting input.

The signal generator has a symmetric, ground-referenced bipolar output. The  $V_{OCM}$  pin of the ADA4937 is left floating, allowing the internal divider to set the output common-mode voltage at midsupply. One half of the common-mode voltage is fed back to the summing nodes, biasing  $-IN$  and  $+IN$  at 1.25 V. For a common-mode voltage of 2.5 V, each ADA4937 output swings between 2.0 V and 3.0 V, providing a 2 V p-p differential output.

The output of the amplifier is ac-coupled to the ADC through a second-order, low-pass filter with a cutoff frequency of 100 MHz. This reduces the noise bandwidth of the amplifier and isolates the driver outputs from the ADC inputs.

The AD9445 is configured for a 2 V p-p full-scale input by connecting the SENSE pin to AGND, as shown in Figure 61.

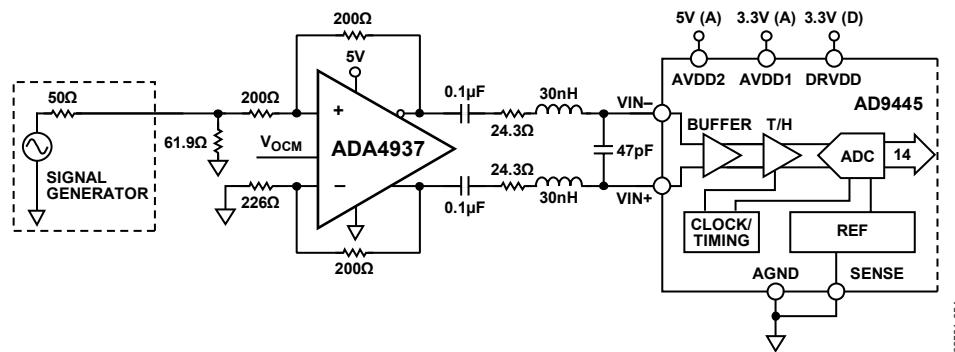

Figure 61. ADA4937 Driving an AD9445, a 14-Bit, 105 MSPS ADC



# ADA4937-1/ADA4937-2

The circuit in Figure 63 shows a simplified front-end connection for an ADA4937 driving an AD9246, 14-bit, 125 MSPS ADC. The AD9246 achieves its optimum performance when driven differentially. The ADA4937 performs the single-ended-to-differential conversion, eliminating the need for a transformer to drive the ADC.

The ADA4937 is configured with a single 5 V supply and a gain of  $\sim 2$  V/V for a single-ended input to differential output. The  $76.8\ \Omega$  termination resistor, in parallel with the single-ended input impedance of  $137\ \Omega$ , provides a  $50\ \Omega$  ac termination for the source. The additional  $30\ \Omega$  ( $120\ \Omega$  total) at the inverting input balances the parallel ac impedance of the  $50\ \Omega$  source and the termination resistor driving the noninverting input.

The signal generator has a symmetric, ground-referenced bipolar output. The  $V_{OCM}$  pin of the ADA4937 is left unconnected; therefore, the internal pull-ups set the output common-mode voltage to midsupply. A portion of this is fed back to the summing nodes, biasing  $-IN$  and  $+IN$  at  $0.55$  V. For a common-mode voltage of  $2.5$  V, each ADA4937 output swings between  $2.0$  V and  $3.0$  V, providing a  $2$  V p-p differential output.

The output is ac-coupled to a single-pole, low-pass filter. This reduces the noise bandwidth of the amplifier and provides some level of isolation from the switched capacitor inputs of the ADC. The AD9246 is set for a  $2$  V p-p full-scale input by connecting

the SENSE pin to AGND. The inputs of the AD9246 are biased at  $1$  V by connecting the CML output, as shown in Figure 63.

The circuit was tested with a  $-1$  dBFS signal at various frequencies. Figure 62 shows a plot of the second and third harmonic distortion (HD2/HD3) vs. frequency.

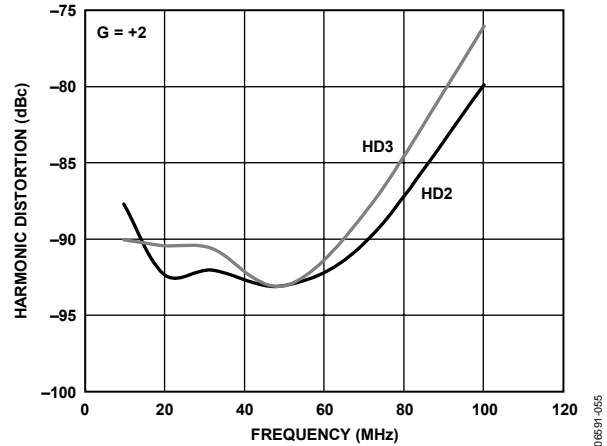

Figure 62. HD2/HD3 for Combination of ADA4937 and AD9246 ADC

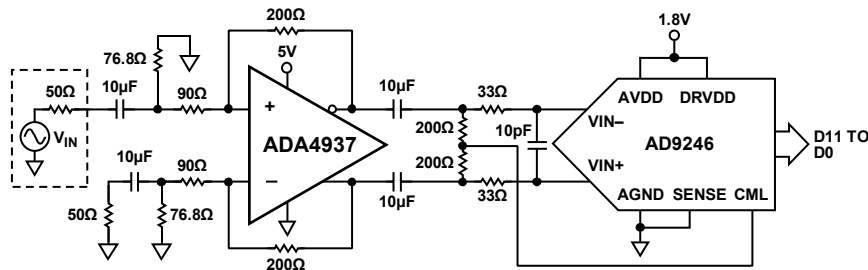

Figure 63. ADA4937 Driving an AD9246, a 14-Bit, 125 MSPS ADC



## 3.3 V OPERATION

The ADA4937 provides excellent performance in 3.3 V single-supply applications. Significant power savings can be realized when the ADA4937 is used in combination with a low voltage ADC.

The circuit in Figure 64 is an example of the ADA4937 driving an AD9230, 12-bit, 250 MSPS ADC that is specified to operate with a single 1.8 V supply. The performance of the ADC is optimized when it is driven differentially, making the best use of the signal swing available within the 1.8 V supply. The ADA4937 performs the single-ended-to-differential conversion, common-mode level-shifting, and buffering of the driving signal.

The ADA4937 is configured with a single 3.3 V supply and a gain of 2 V/V for a single-ended input to differential output. The

59  $\Omega$  termination resistor, in parallel with the single-ended input impedance of 306  $\Omega$ , provides a 50  $\Omega$  termination for the source. The additional 26  $\Omega$  (226  $\Omega$  total) at the inverting input balances the parallel impedance of the 50  $\Omega$  source and termination resistor driving the noninverting input. The signal generator has a symmetric, ground-referenced bipolar output. The  $V_{OCM}$  pin is connected to the CML output of the AD9230, and sets the output common mode of the ADA4937 at 1.4 V. One third of the output common-mode voltage of the amplifier is fed back to the summing nodes, biasing  $-IN$  and  $+IN$  at  $\sim 0.5$  V. For a common-mode voltage of 1.4 V, each ADA4937 output swings between 1.09 V and 1.71 V, providing a 1.25 V p-p differential output.

A third-order, 125 MHz, low-pass filter between the ADA4937 and the AD9230 reduces the noise bandwidth of the amplifier and isolates the driver outputs from the ADC inputs.

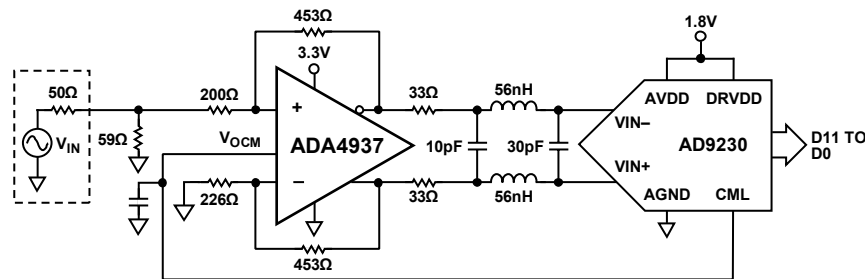
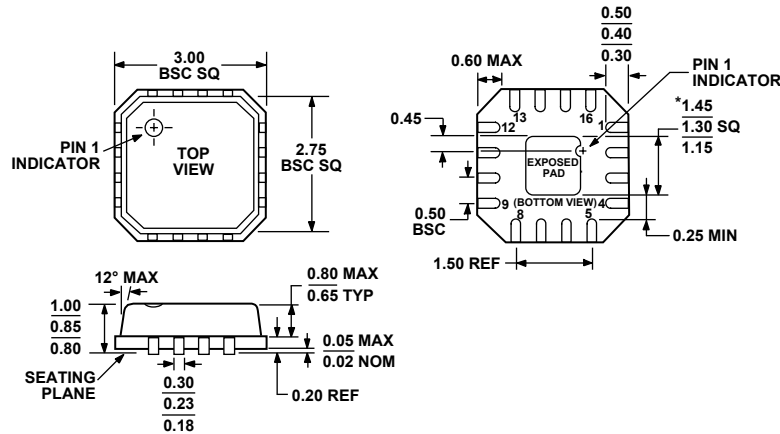

Figure 64. ADA4937 Driving an AD9230, a 12-Bit, 250 MSPS ADC

06591-057

## OUTLINE DIMENSIONS



\*COMPLIANT TO JEDEC STANDARDS MO-220-VEED-2 EXCEPT FOR EXPOSED PAD DIMENSION.

Figure 65. 16-Lead Lead Frame Chip Scale Package [LFCSP\_VQ]  
3 mm × 3 mm Body, Very Thin Quad  
(CP-16-2)  
Dimensions shown in millimeters

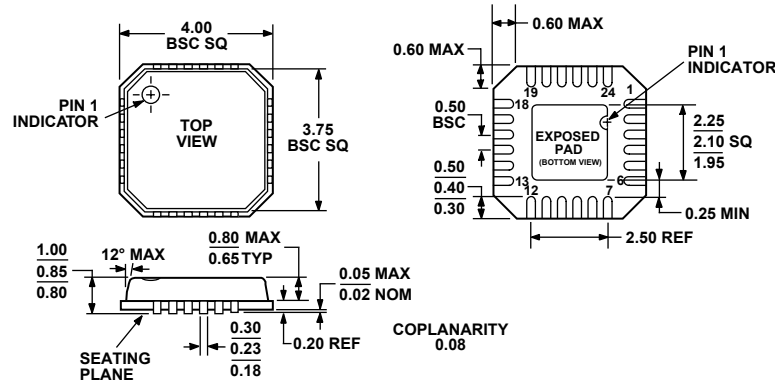

COMPLIANT TO JEDEC STANDARDS MO-220-VGGD-2

Figure 66. 24-Lead Lead Frame Chip Scale Package [LFCSP\_VQ]  
4 mm × 4 mm Body, Very Thin Quad  
(CP-24-1)  
Dimensions shown in millimeters

## ORDERING GUIDE

Model	Temperature Range	Package Description	Package Option	Ordering Quantity	Branding
ADA4937-1YCPZ-R2 <sup>1</sup>	-40°C to +105°C	16-Lead LFCSP_VQ	CP-16-2	5,000	H1S
ADA4937-1YCPZ-RL <sup>1</sup>	-40°C to +105°C	16-Lead LFCSP_VQ	CP-16-2	1,500	H1S
ADA4937-1YCPZ-R7 <sup>1</sup>	-40°C to +105°C	16-Lead LFCSP_VQ	CP-16-2	250	H1S
ADA4937-2YCPZ-R2 <sup>1</sup>	-40°C to +85°C	24-Lead LFCSP_VQ	CP-24-1	5,000	
ADA4937-2YCPZ-RL <sup>1</sup>	-40°C to +85°C	24-Lead LFCSP_VQ	CP-24-1	1,500	
ADA4937-2YCPZ-R7 <sup>1</sup>	-40°C to +85°C	24-Lead LFCSP_VQ	CP-24-1	250	

<sup>1</sup> Z = RoHS Compliant Part.

**NOTES**

**NOTES**