

# Ethernet DC/DC Converter EPC1108P & EPC1108H

- Features**
- 70 % Typical efficiency at full load @ nominal input voltage
  - Regulated Output
  - Input / Output Isolation
  - Input filter to reduce input ripple current
  - Designed for low common mode noise

## Electrical Specifications

\*Note : Package with G = Surface Mount Device, ††: E1,E1-G,E4,E4-G,E11,Q,Q1

PCA P/N	Standard Package	Optional Packages	Input Voltage V	Output Voltage V	Output Current mA Max.	Output Ripple & Noise @ 20 MHz BW mV p-p	Isolation Vrms
EPC1108P	E	E-G*, F2,N1,††	5.0 ± 10%	5.0 ± 5%	20 Max.	100 Max.	500
EPC1108H	E1	E1-G*,E11,N1,Q1	5.0 ± 10%	5.0 ± 5%	20 Max.	100 Max.	2000

### Pin Connections for E

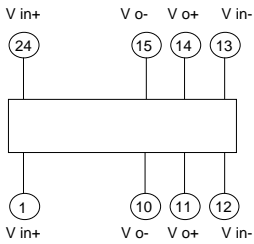

### Pin Connections for Q1

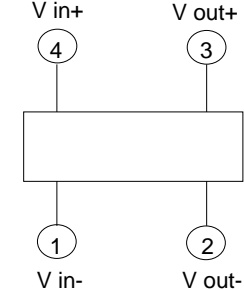

### Pin Connections for N1

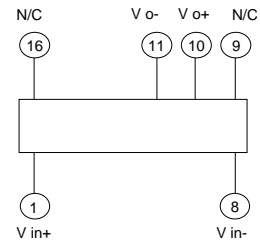

### Pin Connections for F2

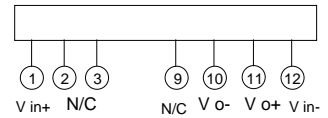

### PACKAGE E

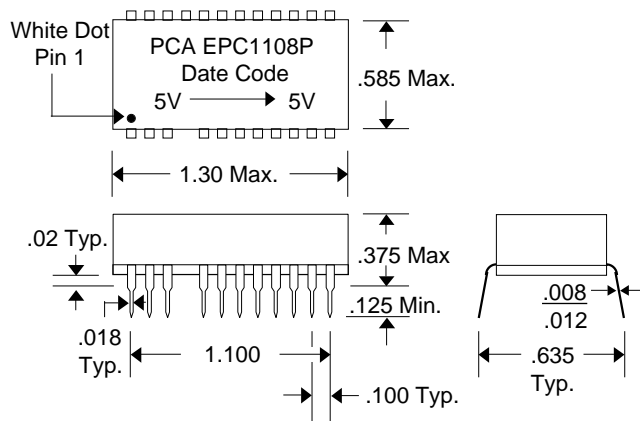

### PACKAGE F2

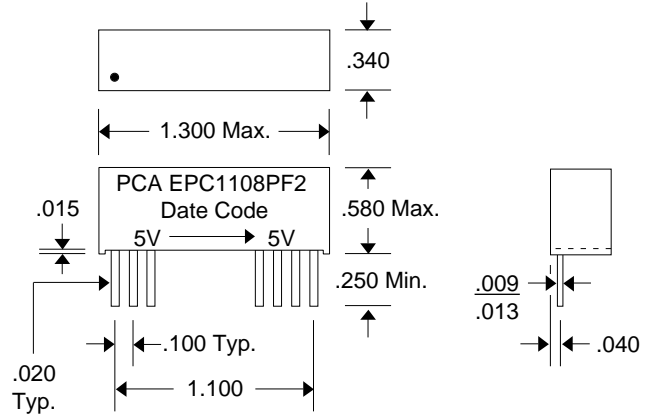

### PACKAGE Q1

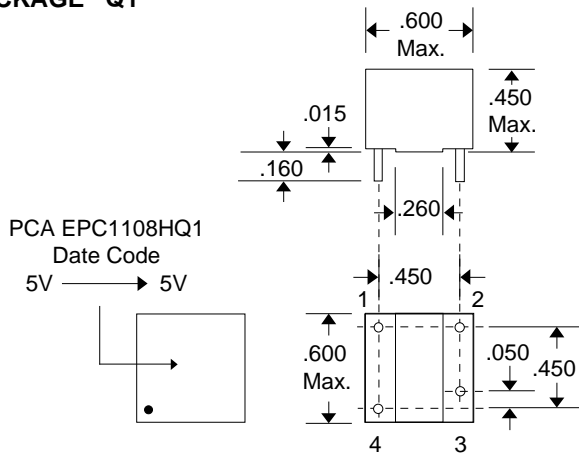

### PACKAGE N1

