

TB2901H

Maximum Power 47 W BTL × 4-ch Audio Power IC

The TB2901H is 4-ch BTL audio amplifier for car audio applications.

This IC can generate higher power: $POUT_{MAX} = 47\text{ W}$ as it includes the pure complementary P-ch and N-ch DMOS output stage.

It is designed to yield low distortion ratio for 4-ch BTL audio power amplifier, built-in standby function, muting function, and various kinds of protectors.

Additionally, high-side switch is built in.

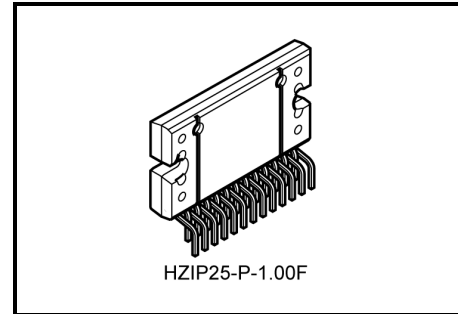

Weight: 7.7 g (typ.)

Features

- High power output
 - : $POUT_{MAX} (1) = 47\text{ W}$ (typ.)
($V_{CC} = 14.4\text{ V}$, $f = 1\text{ kHz}$, JEITA max, $R_L = 4\ \Omega$)
 - : $POUT_{MAX} (2) = 43\text{ W}$ (typ.)
($V_{CC} = 13.7\text{ V}$, $f = 1\text{ kHz}$, JEITA max, $R_L = 4\ \Omega$)
 - : $POUT_{MAX} (3) = 80\text{ W}$ (typ.)
($V_{CC} = 14.4\text{ V}$, $f = 1\text{ kHz}$, JEITA max, $R_L = 2\ \Omega$)
 - : $POUT (1) = 29\text{ W}$ (typ.)
($V_{CC} = 14.4\text{ V}$, $f = 1\text{ kHz}$, THD = 10%, $R_L = 4\ \Omega$)
 - : $POUT (2) = 25\text{ W}$ (typ.)
($V_{CC} = 13.2\text{ V}$, $f = 1\text{ kHz}$, THD = 10%, $R_L = 4\ \Omega$)
 - : $POUT (3) = 55\text{ W}$ (typ.)
($V_{CC} = 14.4\text{ V}$, $f = 1\text{ kHz}$, THD = 10%, $R_L = 2\ \Omega$)
- Low distortion ratio: THD = 0.015% (typ.)
($V_{CC} = 13.2\text{ V}$, $f = 1\text{ kHz}$, $POUT = 5\text{ W}$, $R_L = 4\ \Omega$)
- Low noise: $V_{NO} = 90\ \mu\text{V}_{rms}$ (typ.)
($V_{CC} = 13.2\text{ V}$, $R_g = 0\ \Omega$, BW = 20 Hz~20 kHz, $R_L = 4\ \Omega$)
- Built-in standby switch function (pin 4)
- Built-in muting function (pin 22)
- Built-in high-side switch function (pin 25)
- Built-in various protection circuits:
 - Thermal shut down, overvoltage, out to GND, out to V_{CC} , out to out short
- Operating supply voltage: $V_{CC (opr)} = 9\sim 18\text{ V}$ ($R_L = 4\ \Omega$)

Note 1: Since this device's pins have a low withstanding voltage, please handle it with care.

Block Diagram

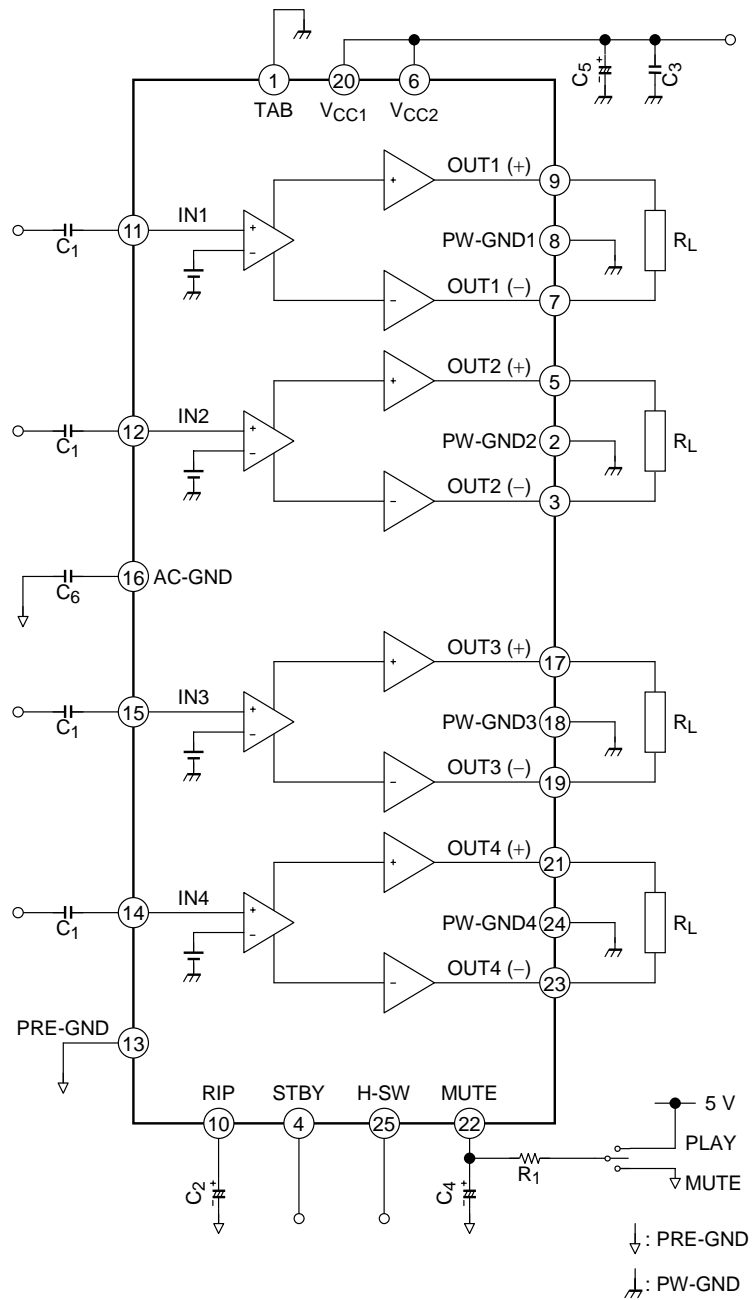

Caution and Application Method

(Description is made only on the single channel.)

1. Voltage Gain Adjustment

This IC has no NF (negative feedback) Pins. Therefore, the voltage gain can not be adjusted, but it makes the device a space and total costs saver.

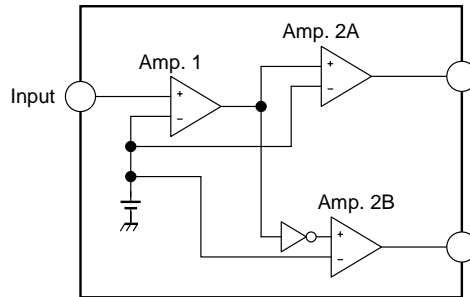

Figure 1 Block Diagram

The voltage gain of amp.1 : $GV_1 = 0\text{dB}$

The voltage gain of amp.2A, B : $GV_2 = 20\text{dB}$

The voltage gain of BTL connection: $GV(\text{BTL}) = 6\text{dB}$

Therefore, the total voltage gain is decided by expression below.

$$GV = GV_1 + GV_2 + GV(\text{BTL}) = 0 + 20 + 6 = 26\text{dB}$$

2. Standby SW Function (pin 4)

By means of controlling pin 4 (standby pin) to High and Low, the power supply can be set to ON and OFF. The threshold voltage of pin 4 is set at about $3V_{BE}$ (typ.), and the power supply current is about $2\mu\text{A}$ (typ.) in the standby state.

Control Voltage of Pin 4: V_{SB}

Standby	Power	V_{SB} (V)
ON	OFF	0~1.5
OFF	ON	3.5~6 V

When changing the time constant of pin 4, check the pop noise.

Advantage of Standby SW

- (1) Since VCC can directly be controlled to ON or OFF by the microcomputer, the switching relay can be omitted.
- (2) Since the control current is microscopic, the switching relay of small current capacity is satisfactory for switching.

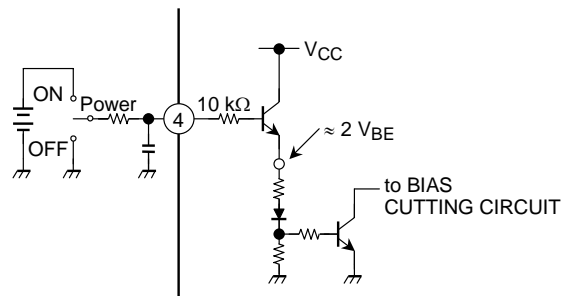

Figure 2 With pin 4 set to High, Power is turned ON

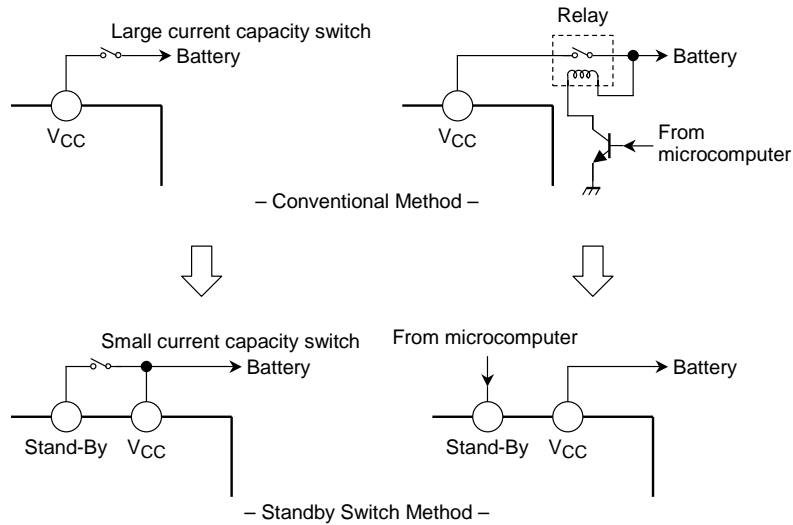

Figure 3

3. Muting Function (pin 22)

Audio muting function is enabled when pin 22 is Low. When the time constant of the muting function is determined by R_1 and C_4 , it should take into account the pop noise. The pop noise which is generated when the power or muting function is turned ON/OFF will vary according to the time constant. (Refer to Figure 4 and Figure 5.)

The pin 22 is designed to operate off 5 V.

Moreover, this terminal (pin 22) serves as the source switch of current of an internal mute circuit. And it is designed so that the discharge current of this terminal (pin 22) may serve as 200 μ A. The outside pull-up resistor R_1 is determined on the basis of this value.

ex) When control voltage is changed in to 6 V from 5 V.

$$6 \text{ V} / 5 \text{ V} \times 47 \text{ k} = 56 \text{ k}$$

To obtain enough mute attenuation, a series resistor, R_1 at pin 22 should be 47 k Ω or more.

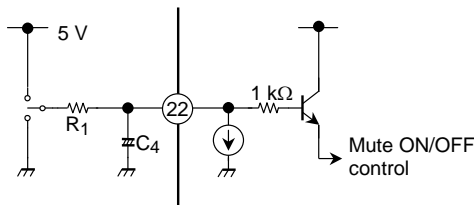

Figure 4 Muting Function

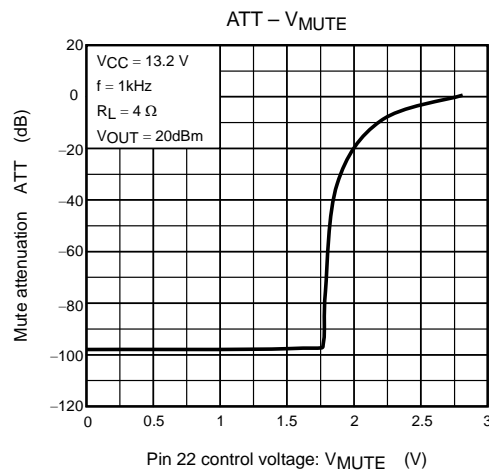

Figure 5 Mute Attenuation - V_{MUTE} (V)

4. High-Side Switch

Pin 25 of this device is used in concerned with V_{CC} as a high-side switch which operates with the standby pin. Thus, both the power amp IC and the connected external unit (the hideaway unit) can be turned ON/OFF by using of the standby switch.

5. Pop Noise Suppression

Since the AC-GND pin (pin 16) is used as the NF pin for all amps, the ratio between the input capacitance (C1) and the AC-to-GND capacitance (C6) should be 1:4.

Also, if the power is turned OFF before the C1 and C6 batteries have been completely charged, pop noise will be generated because of the DC input umbalance.

To counteract the noise, it is recommended that a longer charging time be used for C2 as well as for C1 and C6. Note that the time which audio output takes to start will be longer, since the C2 makes the muting time (the time from when the power is turned ON to when audio output starts) is fix.

The pop noise which is generated when the muting function is turned ON/OFF will vary according to the time constant of C4.

The greater the capacitance, the lower the pop noise. Note that the time from when the mute control signal is applied to C4 to when the muting function is turned ON/OFF will be longer.

6. External Component Constants

Component Name	Recommended Value	Purpose	Effect		Notes
			Lower than recommended value	Higher than recommended value	
C1	0.22 μ F	To eliminate DC	Cut-off frequency is increased	Cut-off frequency is reduced	Pop noise is generated when V_{CC} is ON
C2	10 μ F	To reduce ripple	Powering ON/OFF is faster	Powering ON/OFF takes longer	
C3	0.1 μ F	To provide sufficient oscillation margin	Reduces noise and provides sufficient oscillation margin		
C4	1 μ F	To reduce pop noise	High pop noise. Duration until muting function is turned ON/OFF is short	Low pop noise. Duration until muting function is turned ON/OFF is long	
C5	3900 μ F	Ripple filter	Power supply ripple filtering		
C6	1 μ F	NF for all outputs	Pop noise is suppressed when C1:C6 = 1:4		Pop noise is generated when V_{CC} is ON

Note: If recommended value is not used.

Maximum Ratings (Ta = 25°C)

Characteristics	Symbol	Rating	Unit
Peak supply voltage (0.2 s)	V _{CC (surge)}	50	V
DC supply voltage	V _{CC (DC)}	25	V
Operation supply voltage	V _{CC (opr)}	18	V
Output current (peak)	I _{O (peak)}	9	A
Power dissipation	P _{D (Note 2)}	125	W
Operation temperature	T _{opr}	-40~85	°C
Storage temperature	T _{stg}	-55~150	°C

Note 2: Package thermal resistance $\theta_{j-T} = 1^{\circ}\text{C}/\text{W}$ (typ.) (Ta = 25°C, with infinite heat sink)

Electrical Characteristics

(unless otherwise specified, V_{CC} = 13.2 V, f = 1 kHz, R_L = 4 Ω, Ta = 25°C)

Characteristics	Symbol	Test Circuit	Test Condition	Min	Typ.	Max	Unit
Quiescent current	I _{CCQ}	—	V _{IN} = 0	—	200	400	mA
Output power	P _{OUT MAX (1)}	—	V _{CC} = 14.4 V, max POWER	—	47	—	W
	P _{OUT MAX (2)}	—	V _{CC} = 13.7 V, max POWER	—	43	—	
	P _{OUT (1)}	—	V _{CC} = 14.4 V, THD = 10%	—	29	—	
	P _{OUT (2)}	—	THD = 10%	23	25	—	
Output power (R _L = 2 Ω)	P _{OUT MAX (3)}	—	V _{CC} = 14.4 V, max POWER	—	80	—	W
	P _{OUT MAX (4)}	—	V _{CC} = 13.7 V, max POWER	—	77	—	
	P _{OUT (3)}	—	V _{CC} = 14.4 V, THD = 10%	—	55	—	
	P _{OUT (4)}	—	THD = 10%	42	45	—	
Total harmonic distortion	THD	—	P _{OUT} = 5 W	—	0.015	0.15	%
Voltage gain	G _V	—	V _{OUT} = 0.775 V _{rms}	24	26	28	dB
Voltage gain ratio	ΔG _V	—	V _{OUT} = 0.775 V _{rms}	-1.0	0	1.0	dB
Output noise voltage	V _{NO (1)}	—	R _g = 0 Ω, DIN45405	—	100	—	μV _{rms}
	V _{NO (2)}	—	R _g = 0 Ω, BW = 20 Hz~20 kHz	—	90	200	
Ripple rejection ratio	R.R.	—	f _{rip} = 100 Hz, R _g = 620 Ω V _{rip} = 0.775 V _{rms}	50	60	—	dB
Cross talk	C.T.	—	R _g = 620 Ω V _{OUT} = 0.775 V _{rms}	—	70	—	dB
Output offset voltage	V _{OFFSET}	—	—	-150	0	150	mV
Input resistance	R _{IN}	—	—	—	90	—	kΩ
Standby current	I _{SB}	—	Standby condition	—	2	10	μA
Standby control voltage	V _{SB H}	—	POWER: ON	3.5	—	6.0	V
	V _{SB L}	—	POWER: OFF	0	—	1.5	
Mute control voltage	V _{M H}	—	MUTE: OFF	3.0	—	6.0	V
	V _{M L}	—	MUTE: ON, R ₁ = 47 kΩ	0	—	0.5	
Mute attenuation	ATT M	—	MUTE: ON V _{OUT} = 7.75 V _{rms} → Mute: OFF	80	90	—	dB

High-Side Switch

Output current	I _O	—	400	—	—	—	mA
Difference voltage between V _{CC} and output	ΔV _O	—	I _O = 400 mA, +B = 9.6 V	—	0.25	0.6	V

Test Circuit

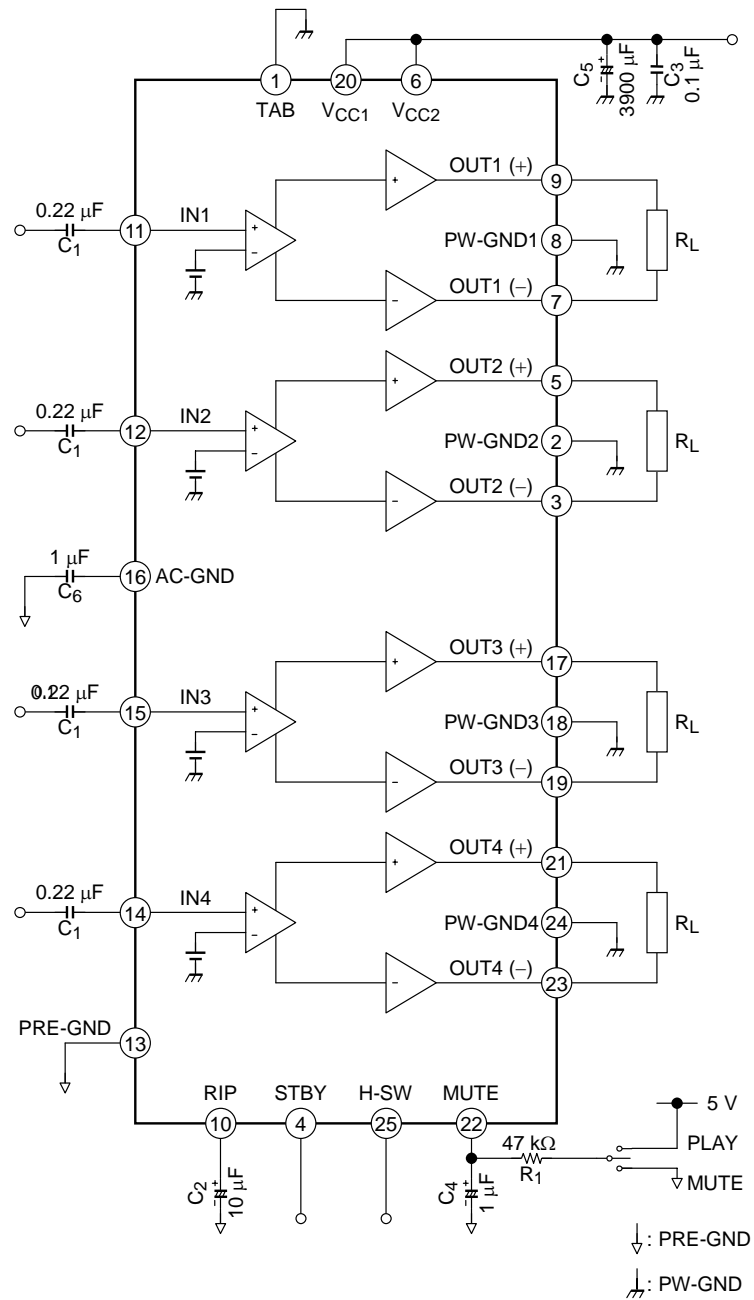

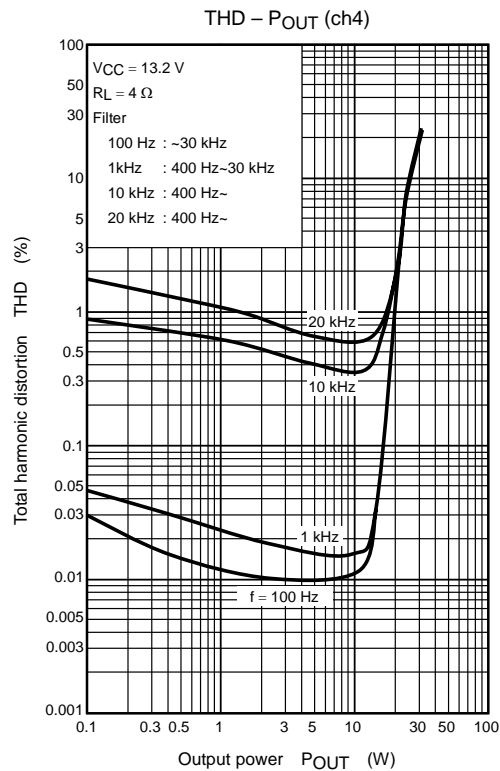
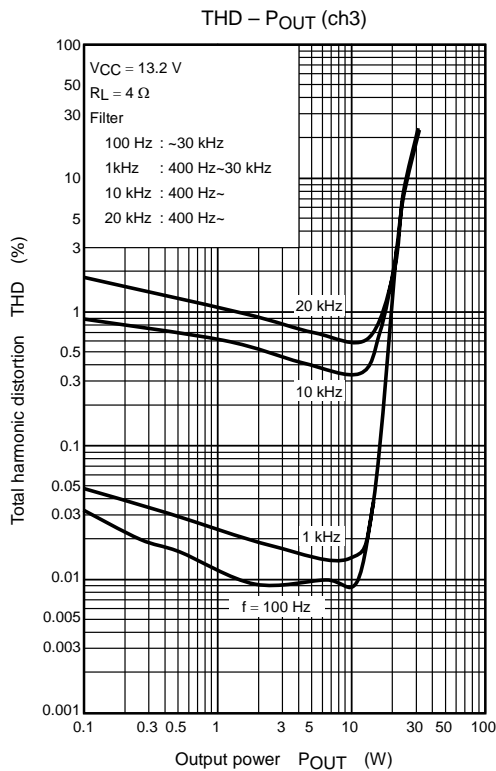
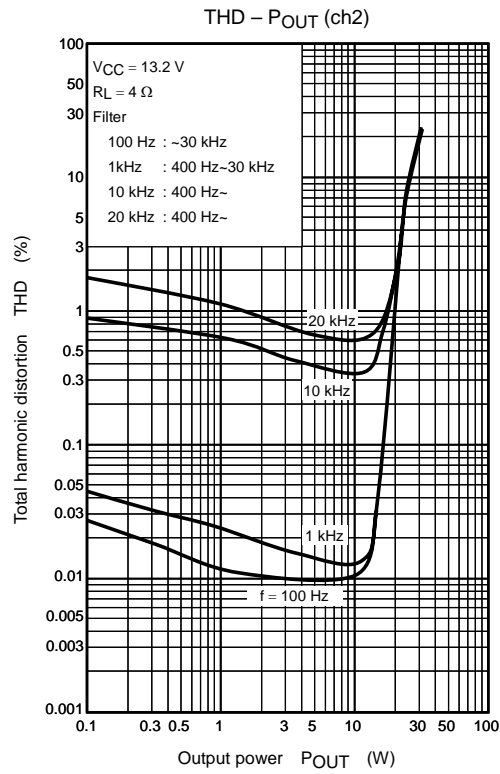
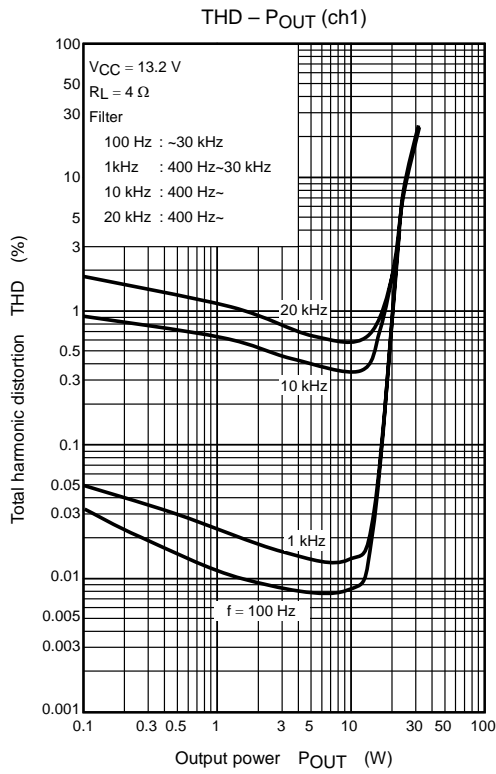

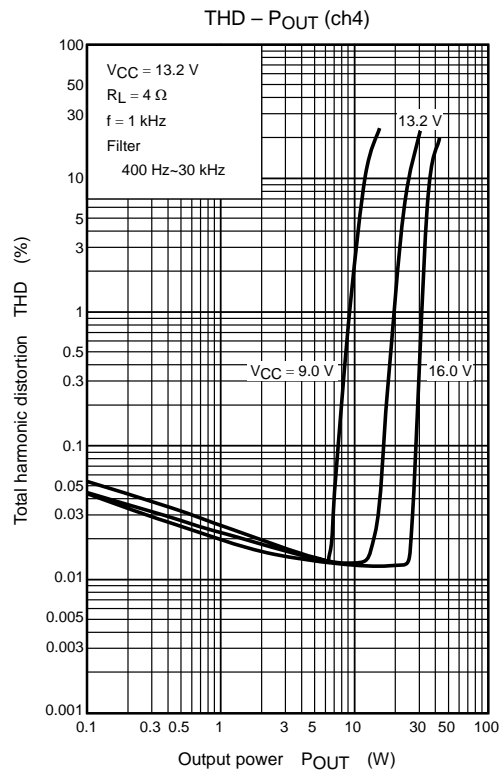
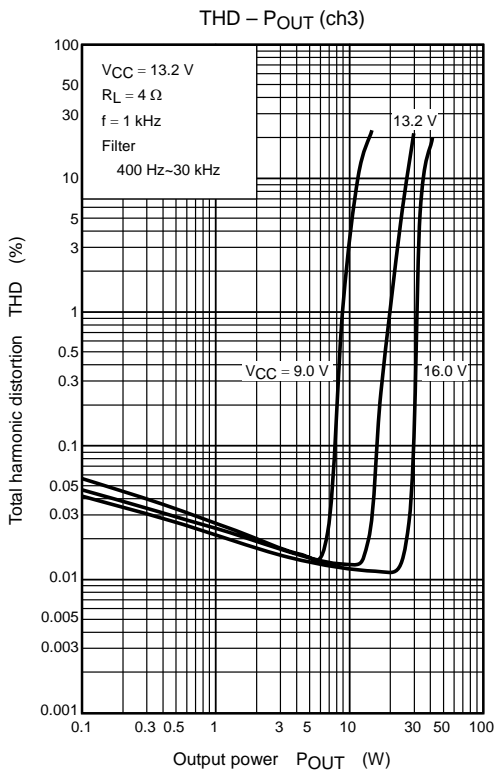
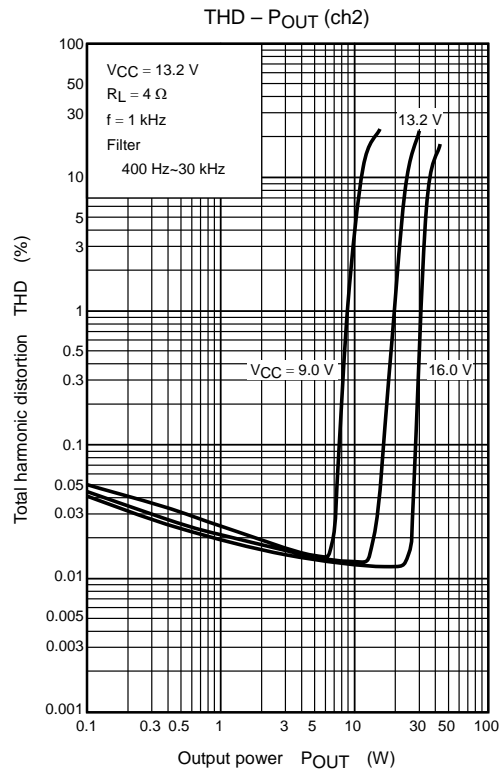
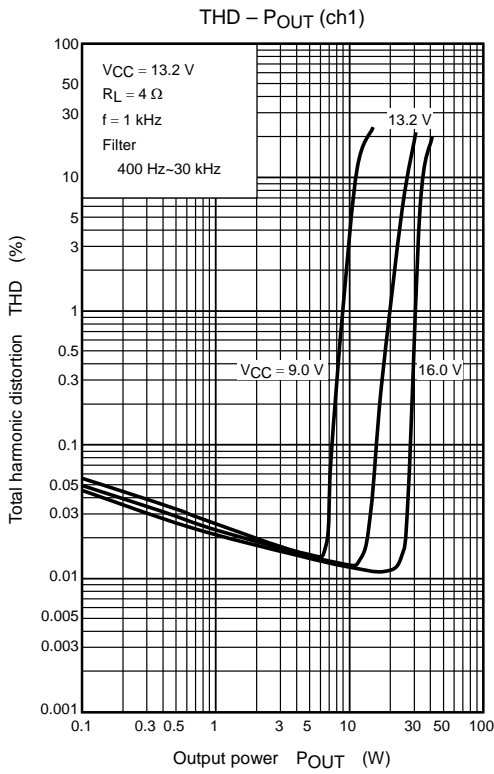

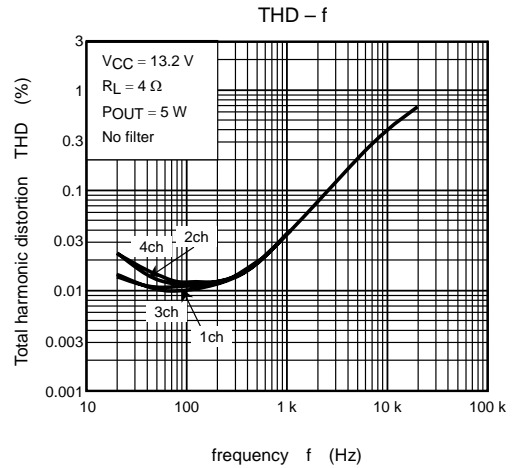
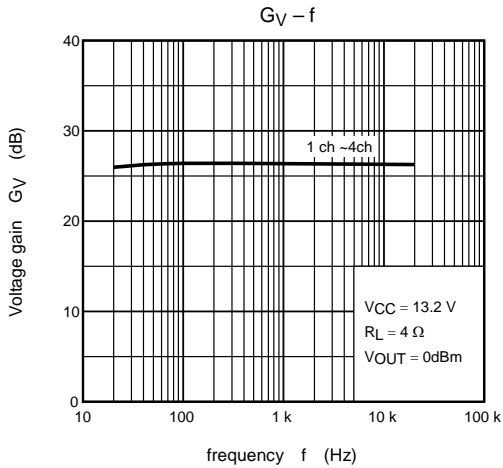
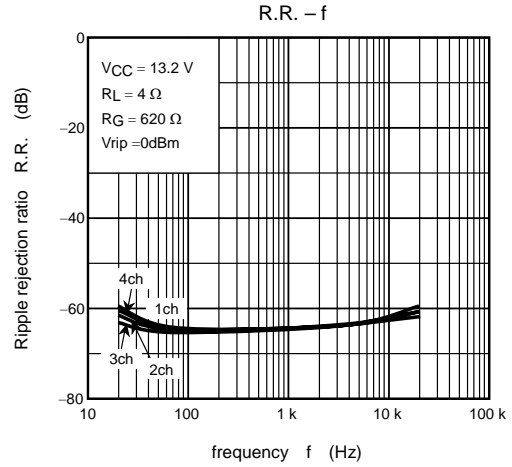
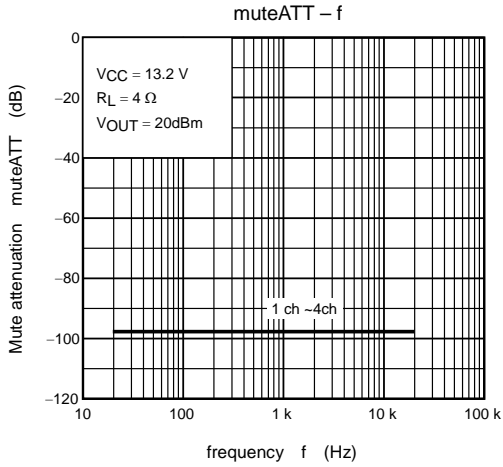

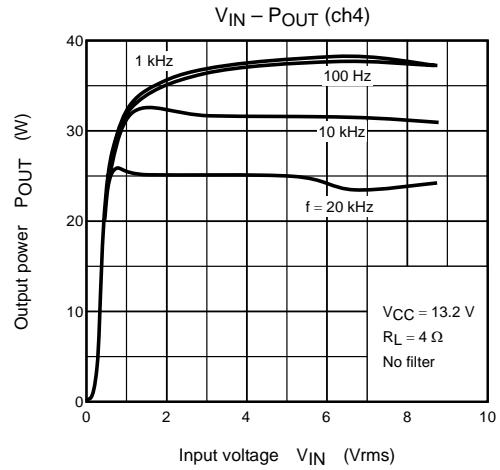
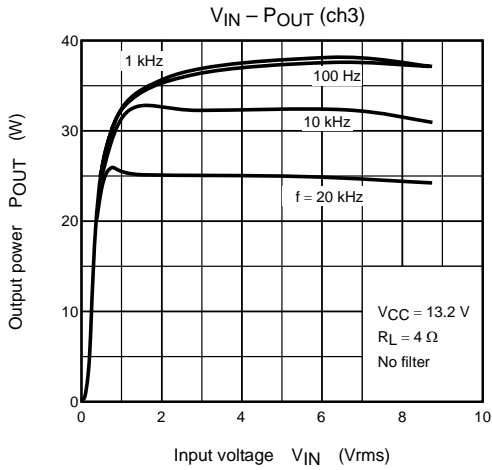
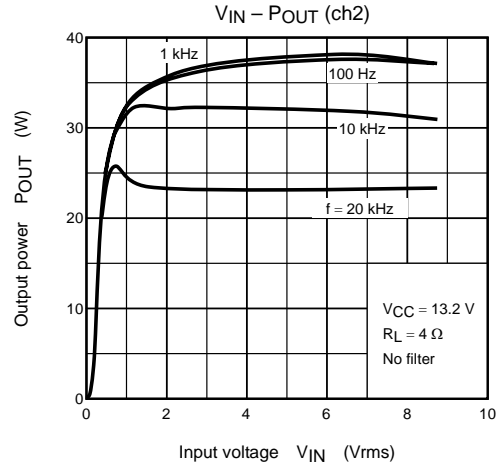
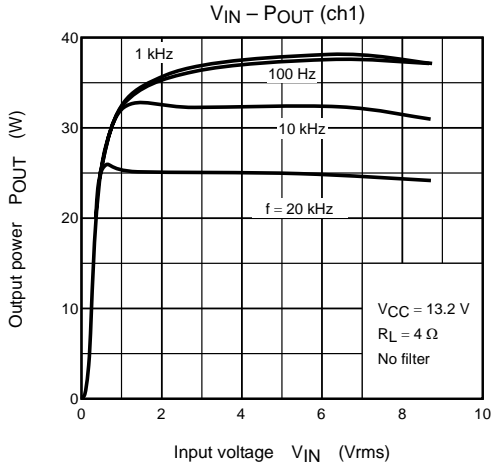

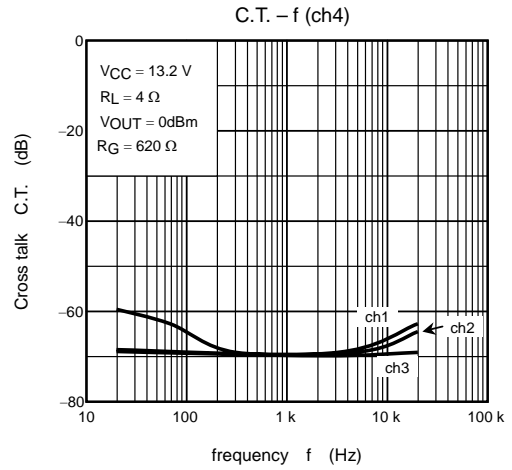
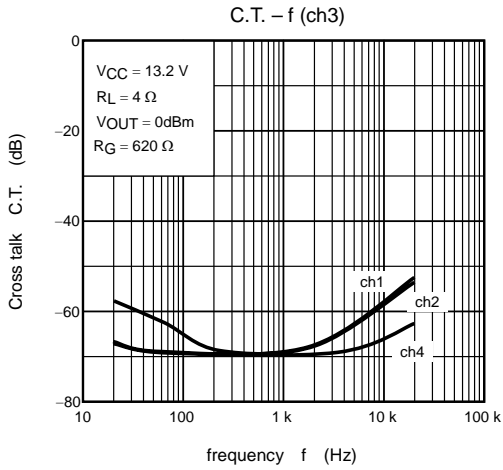
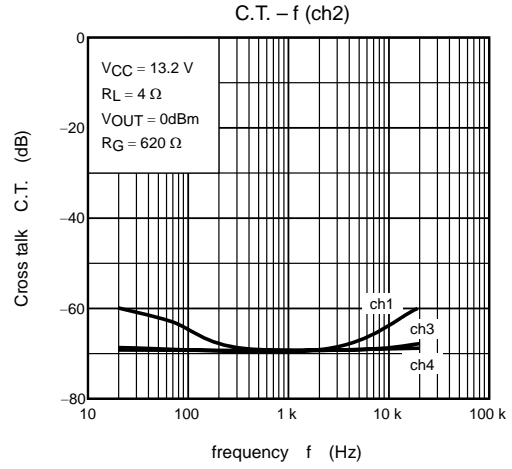
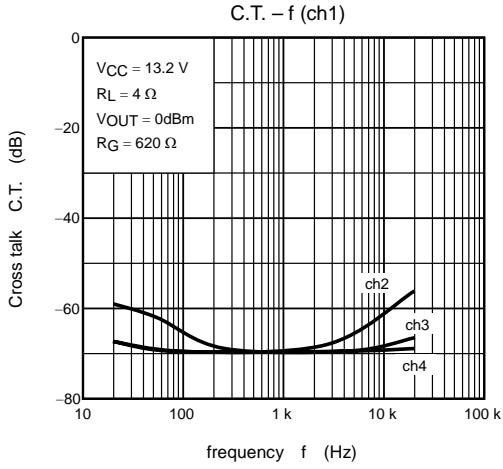

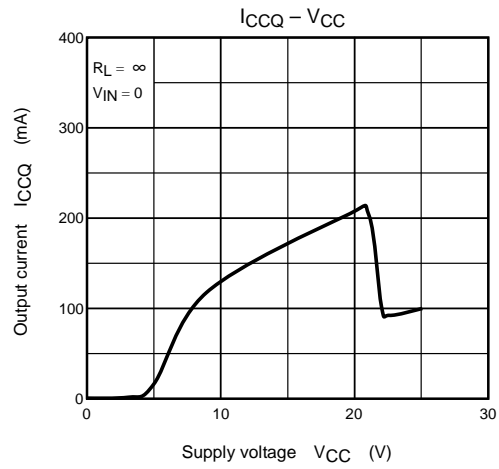
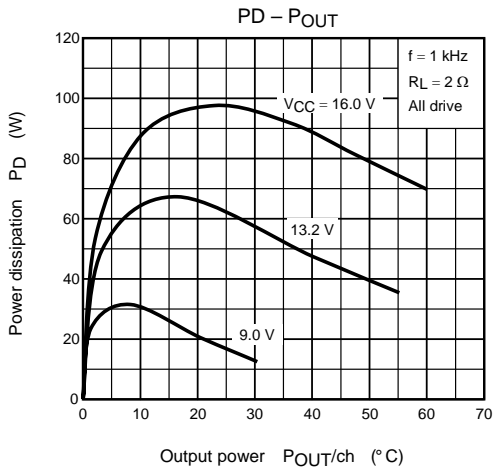
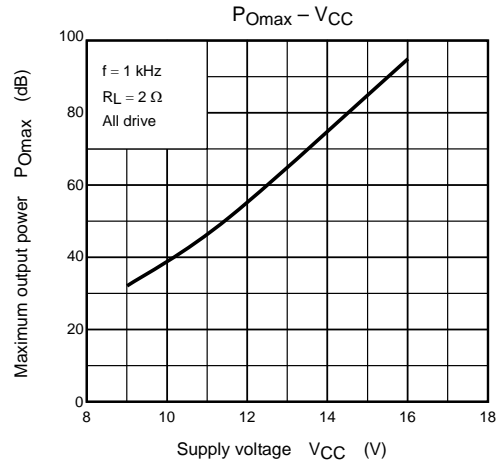
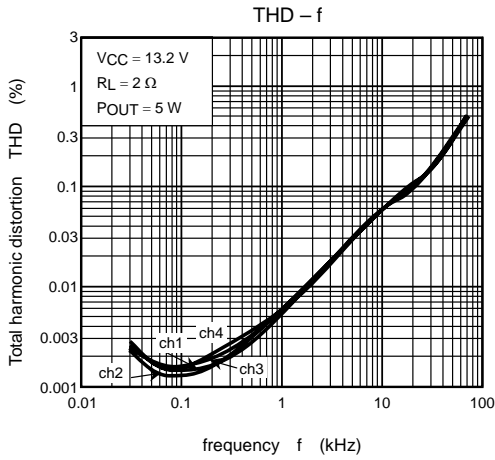
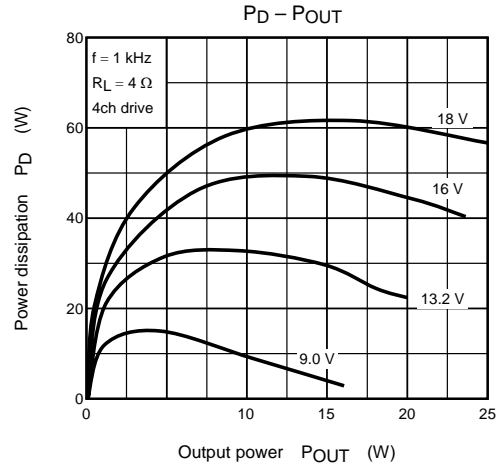
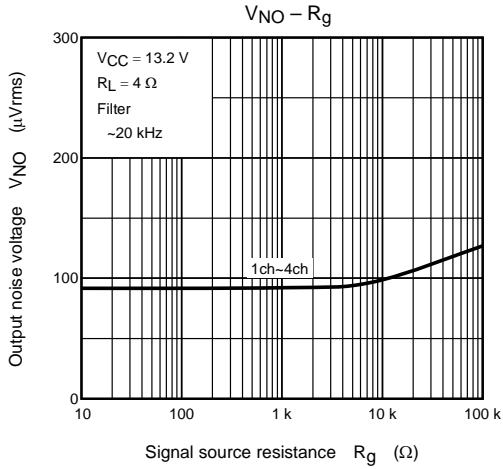

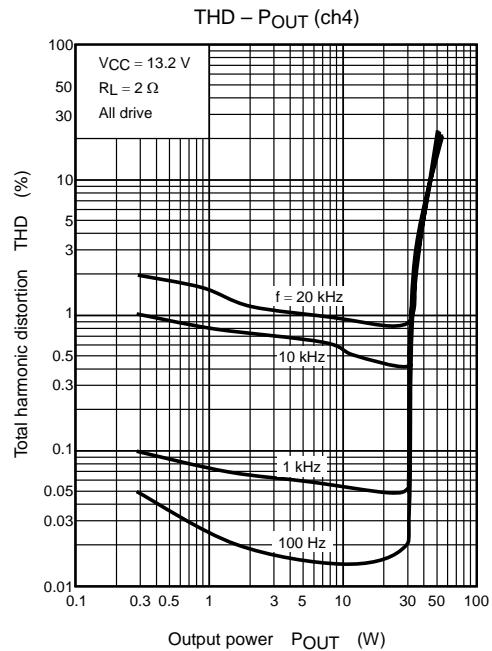
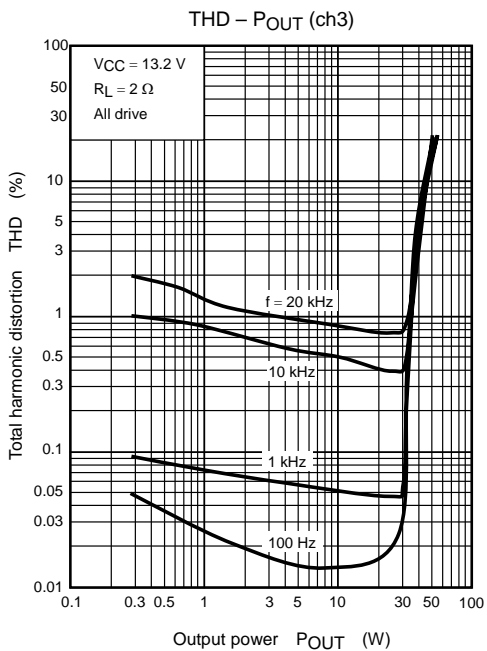
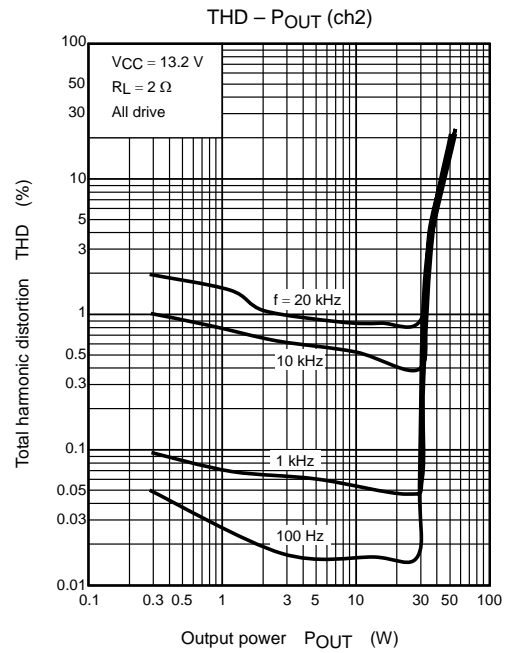
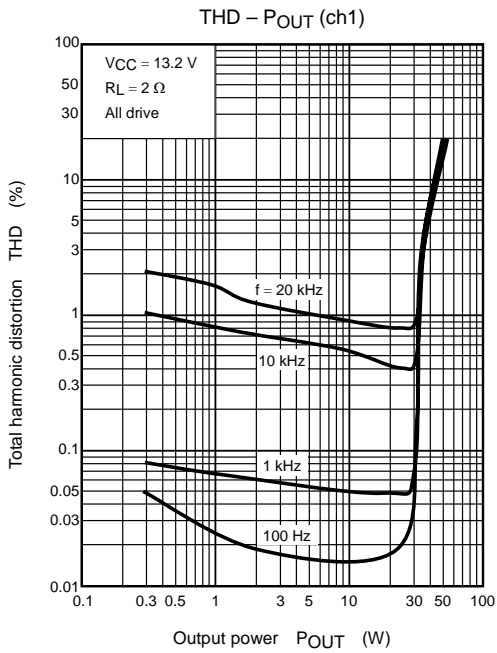

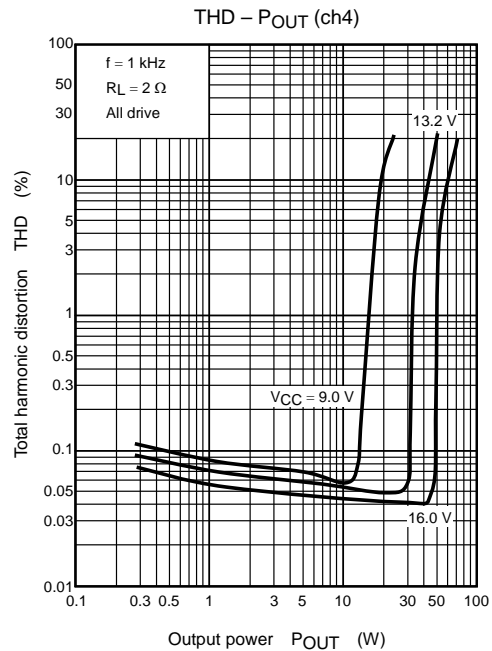
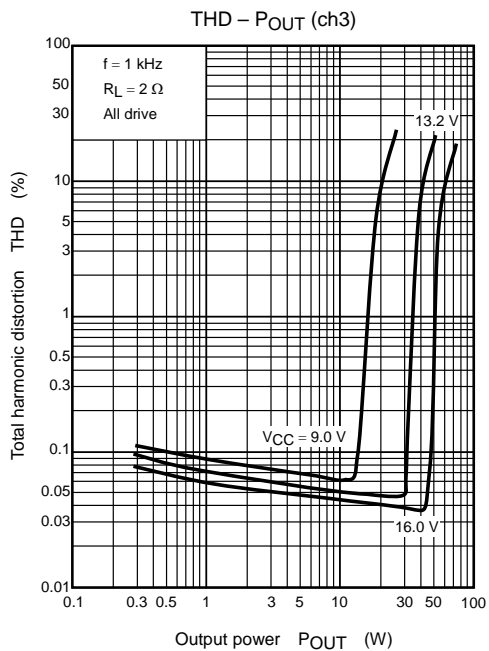
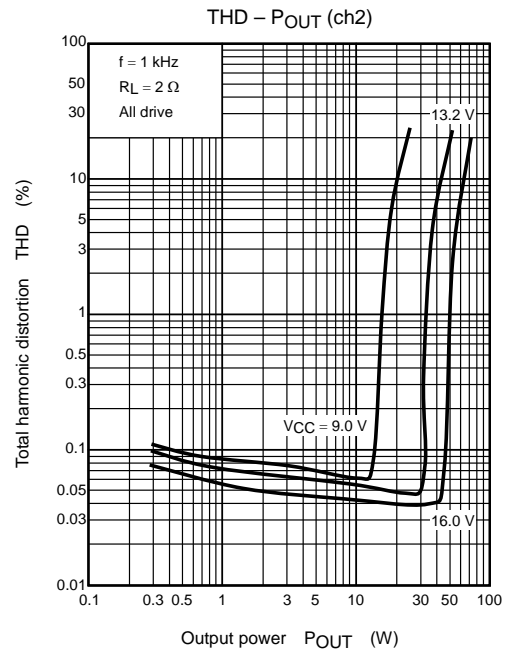
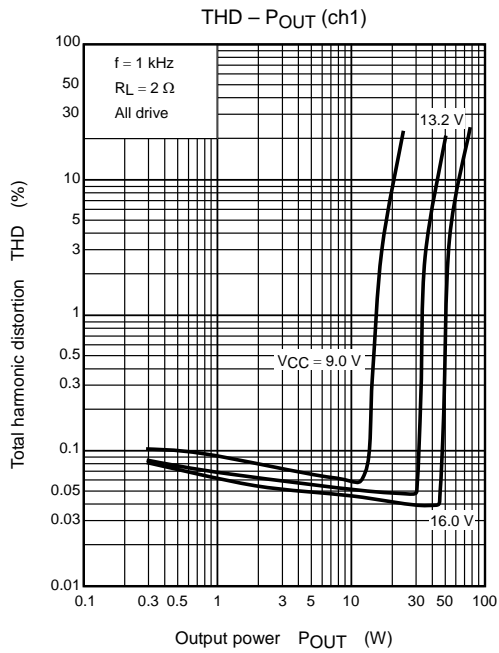

RESTRICTIONS ON PRODUCT USE

000707EBF

- TOSHIBA is continually working to improve the quality and reliability of its products. Nevertheless, semiconductor devices in general can malfunction or fail due to their inherent electrical sensitivity and vulnerability to physical stress. It is the responsibility of the buyer, when utilizing TOSHIBA products, to comply with the standards of safety in making a safe design for the entire system, and to avoid situations in which a malfunction or failure of such TOSHIBA products could cause loss of human life, bodily injury or damage to property.
In developing your designs, please ensure that TOSHIBA products are used within specified operating ranges as set forth in the most recent TOSHIBA products specifications. Also, please keep in mind the precautions and conditions set forth in the "Handling Guide for Semiconductor Devices," or "TOSHIBA Semiconductor Reliability Handbook" etc..
- The TOSHIBA products listed in this document are intended for usage in general electronics applications (computer, personal equipment, office equipment, measuring equipment, industrial robotics, domestic appliances, etc.). These TOSHIBA products are neither intended nor warranted for usage in equipment that requires extraordinarily high quality and/or reliability or a malfunction or failure of which may cause loss of human life or bodily injury ("Unintended Usage"). Unintended Usage include atomic energy control instruments, airplane or spaceship instruments, transportation instruments, traffic signal instruments, combustion control instruments, medical instruments, all types of safety devices, etc.. Unintended Usage of TOSHIBA products listed in this document shall be made at the customer's own risk.
- This product generates heat during normal operation. However, substandard performance or malfunction may cause the product and its peripherals to reach abnormally high temperatures.
The product is often the final stage (the external output stage) of a circuit. Substandard performance or malfunction of the destination device to which the circuit supplies output may cause damage to the circuit or to the product.
- The products described in this document are subject to the foreign exchange and foreign trade laws.
- The information contained herein is presented only as a guide for the applications of our products. No responsibility is assumed by TOSHIBA CORPORATION for any infringements of intellectual property or other rights of the third parties which may result from its use. No license is granted by implication or otherwise under any intellectual property or other rights of TOSHIBA CORPORATION or others.
- The information contained herein is subject to change without notice.