

# TB2921AHQ

## 51 W × 4-ch BTL Audio Power IC

The TB2921AHQ is a four-channel BTL power amplifier for car audio applications.

This IC has a pure complementary P-ch and N-ch DMOS output stage, offering maximum output power (P<sub>OUT MAX</sub>) of 51 W.

It includes a standby switch, mute function, a high-side switch and various protection features.

### Features

- High output power
  - P<sub>OUT MAX</sub> (1) = 51 W (typ.)  
(V<sub>CC</sub> = 15.2 V, f = 1 kHz, JEITA max, R<sub>L</sub> = 4 Ω)
  - P<sub>OUT MAX</sub> (2) = 45 W (typ.)  
(V<sub>CC</sub> = 13.7 V, f = 1 kHz, JEITA max, R<sub>L</sub> = 4 Ω)
  - P<sub>OUT MAX</sub> (3) = 80 W (typ.)  
(V<sub>CC</sub> = 14.4 V, f = 1 kHz, JEITA max, R<sub>L</sub> = 4 Ω)
  - P<sub>OUT</sub> (1) = 29 W (typ.)  
(V<sub>CC</sub> = 14.4 V, f = 1 kHz, THD = 10%, R<sub>L</sub> = 4 Ω)
  - P<sub>OUT</sub> (2) = 25 W (typ.)  
(V<sub>CC</sub> = 13.2 V, f = 1 kHz, THD = 10%, R<sub>L</sub> = 4 Ω)
- Low THD: 0.005% (typ.) (V<sub>CC</sub> = 13.2 V, f = 1 kHz, P<sub>OUT</sub> = 5 W, R<sub>L</sub> = 4 Ω)
- Low noise: V<sub>NO</sub> = 55 μV<sub>rms</sub> (typ.)  
(V<sub>CC</sub> = 13.2 V, R<sub>g</sub> = 0 Ω, BW = 20 Hz to 20 kHz, R<sub>L</sub> = 4 Ω)
- Standby switch (pin 4)
- Mute function (pin 22)
- High-side switch (H-SW) (pin 25)
- Various protection features  
Thermal overload; overvoltage; output short-circuits to GND, V<sub>CC</sub> and across the load
- Operating supply voltage : V<sub>CC</sub> (opr) = 8.0 to 18 V (R<sub>L</sub> = 4 Ω)  
: V<sub>CC</sub> (opr) = 8.0 to 16 V (R<sub>L</sub> = 2 Ω)

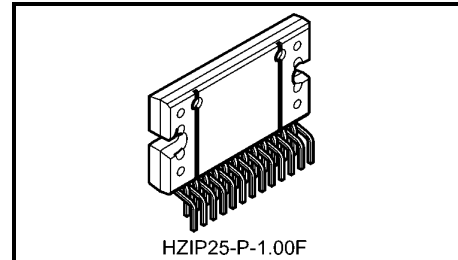

Weight: 7.7 g (typ.)

Note 1: Install the device correctly. Otherwise, the device or system may be degraded, damaged or even destroyed.

Note 2: The protection features are intended to avoid output short-circuits or other abnormal conditions temporarily. It is not guaranteed that they will prevent the IC from being damaged. Exposure to conditions beyond the guaranteed operating ranges may not activate the protection features, resulting in an IC damage due to output short-circuits.

Note 3: The protection circuit may malfunction depending on the connected speaker type due to a phase shift. The operation of the device should therefore be verified by actually connecting a speaker to its outputs. It is not recommended to connect a 2-ohm load such as a subwoofer that induces a significant phase shift, and that special care should be taken in such cases.



Detailed Description

1. Standby Switch (pin 4)

The power supply can be turned on or off via pin 4 (Stby). The threshold voltage of pin 4 is set at about  $3 V_{BE}$  (typ.). The power supply current is about  $0.01 \mu A$  (typ.) in the standby state.

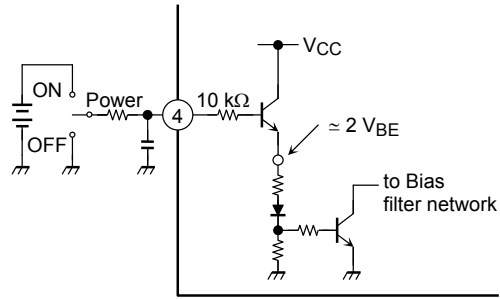

Figure 1 Setting Pin 4 High Turns on Power

Standby Control Voltage ( $V_{SB}$ ): Pin 4

Standby	Power	$V_{SB}$ (V)
ON	OFF	0 to 0.9
OFF	ON	2.9 to $V_{CC}$

Check the pop levels when the time constant of pin 4 is changed.

Benefits of the Standby Switch

- (1)  $V_{CC}$  can be directly turned on or off by a microcontroller, eliminating the need for a switching relay.
- (2) Since the control current is minuscule, a low-current-rated switching relay can be used.

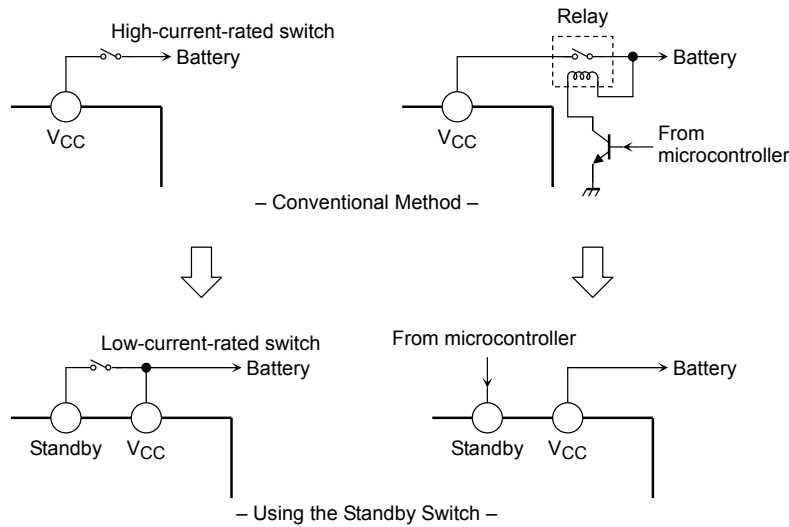

Figure 2 Standby Switch

**2. Mute Function (pin 22)**

The audio mute function is enabled by setting pin 22 Low. R<sub>1</sub> and C<sub>4</sub> determine the time constant of the mute function. The time constant affects pop noise generated when power or the mute function is turned on or off; thus, it must be determined on a per-application basis. (Refer to Figures 3 and 4.)

The value of the external pull-up resistor is determined, based on pop noise value.

For example, when the control voltage is changed from 5 V to 3.3 V, the pull-up resistor should be:  
 $3.3 \text{ V} / 5 \text{ V} \times 47 \text{ k}\Omega = 31 \text{ k}\Omega$

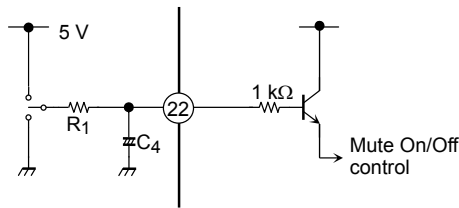

**Figure 3 Mute Function**

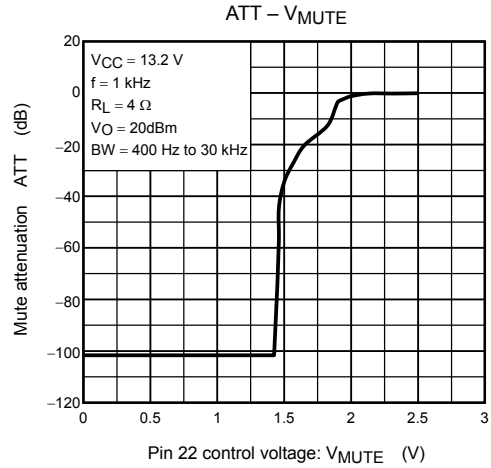

**Figure 4 Mute Attenuation – V<sub>MUTE</sub> (V)**

**3. High-Side Switch**

Pin 25 of this device is used as a high-side switch to a VCC power supply, which is interlocked with a standby pin. Thus, the power amplifier IC and the connected external unit (such as the hideaway unit) can be simultaneously turned on or off by using the standby switch.

**4. DC Offset Detection**

It is possible to use this function by setting the voltage of Pin 22 higher than 8V.

In case of Appearing output offset voltage by Generating a Large Leakage Current on the input Capacitor etc.

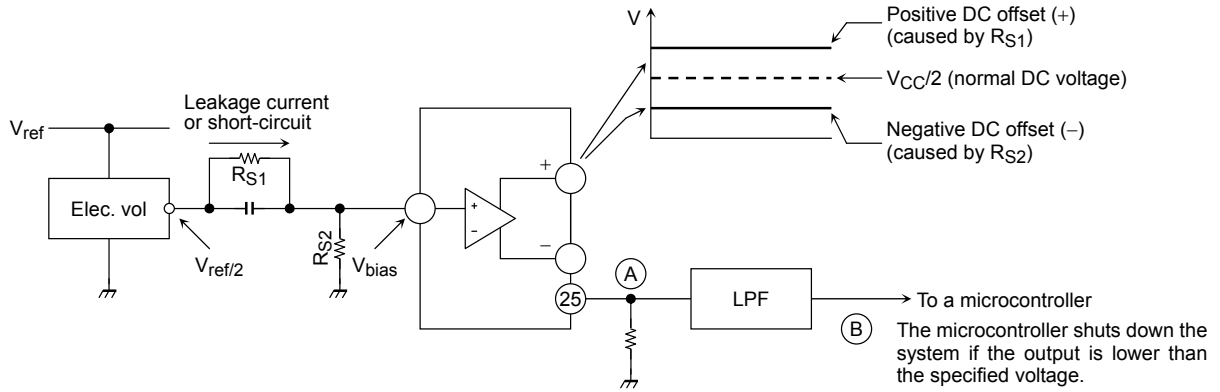

**Figure 5 DC Offset Detection Mechanism**

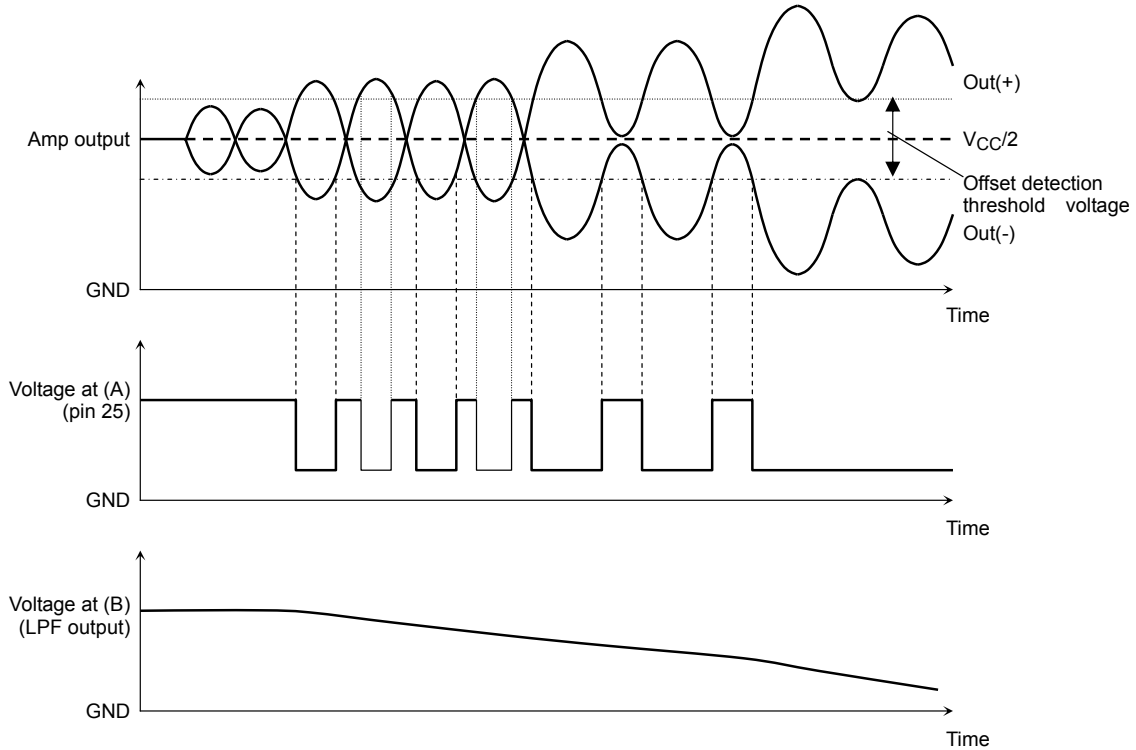

**5. Pop Noise Suppression**

Since the AC-GND pin (pin 16) is used as the input reference voltage pin for all amps, the ratio between the input capacitance (C1) and the AC-to-GND capacitance (C6) should be 1:4.

Also, if the power is turned OFF before the C1 and C6 batteries have been completely charged, pop noise will be generated because of the DC input unbalance.

To counteract the noise, it is recommended that a longer charging time be used for C2 as well as for C1 and C6. Note that the time which audio output takes to start will be longer, since the C2 makes the muting time (the time from when the power is turned ON to when audio output starts) is fix.

The pop noise which is generated when the muting function is turned ON/OFF will vary according to the time constant of C4. The greater the capacitance, the lower the pop noise. Note that the time from when the mute control signal is applied to C4 to when the muting function is turned ON/OFF will be longer.

**6. External Component Constants**

Component	Recommended Value	Purpose	Effects		Notes
			When lower than recommended value	When higher than recommended value	
C1	0.22 $\mu$ F	To eliminate DC	Cut-off frequency is increased.	Cut-off frequency is reduced.	Pop noise is generated when $V_{CC}$ is turned on.
C2	10 $\mu$ F	To reduce ripple	Powering on/off is faster.	Powering on/off is slower.	
C3	0.1 $\mu$ F	To provide sufficient oscillation margin	Reduces noise and provides sufficient oscillation margin		
C4	1 $\mu$ F	To reduce pop noise	High pop noise. Duration until mute function is turned on/off is short.	Low pop noise. Duration until mute function is turned on/off is long.	
C5	3900 $\mu$ F	Ripple filter	Power supply humming and ripple filtering.		
C6	1 $\mu$ F	Reference voltage for all inputs	Pop noise is suppressed when C1: C6 = 1:4.		Pop noise is generated when $V_{CC}$ is turned on.

## Absolute Maximum Ratings (Ta = 25°C)

Characteristics	Symbol	Rating	Unit
Peak supply voltage (0.2 s)	V <sub>CC</sub> (surge)	50	V
DC supply voltage	V <sub>CC</sub> (DC)	25	V
Operating supply voltage	V <sub>CC</sub> (opr)	18	V
Output current (peak)	I <sub>O</sub> (peak)	9	A
Power dissipation	P <sub>D</sub> (Note 4)	125	W
Operating temperature	T <sub>opr</sub>	-40 to 85	°C
Storage temperature	T <sub>stg</sub>	-55 to 150	°C

Note 4: Package thermal resistance  $\theta_{j-T} = 1^{\circ}\text{C/W}$  (typ.) (Ta = 25°C, with infinite heat sink)

The absolute maximum ratings of a semiconductor device are a set of specified parameter values that must not be exceeded during operation, even for an instant.

If any of these ratings are exceeded during operation, the electrical characteristics of the device may be irreparably altered and the reliability and lifetime of the device can no longer be guaranteed.

Moreover, any exceeding of the ratings during operation may cause breakdown, damage and/or degradation in other equipment. Applications using the device should be designed so that no absolute maximum rating will ever be exceeded under any operating conditions.

Before using, creating and/or producing designs, refer to and comply with the precautions and conditions set forth in this document.

## Electrical Characteristics

(V<sub>CC</sub> = 13.2 V, f = 1 kHz, R<sub>L</sub> = 4 Ω, Ta = 25°C unless otherwise specified)

Characteristics	Symbol	Test Circuit	Test Condition	Min	Typ.	Max	Unit
Quiescent supply current	I <sub>CCQ</sub>	—	V <sub>IN</sub> = 0	—	180	300	mA
Output power	P <sub>OUT</sub> MAX (1)	—	V <sub>CC</sub> = 15.2 V, max POWER	—	51	—	W
	P <sub>OUT</sub> MAX (2)	—	V <sub>CC</sub> = 13.7 V, max POWER	—	45	—	
	P <sub>OUT</sub> MAX (3)	—	V <sub>CC</sub> = 14.4 V, R <sub>L</sub> = 2 Ω max POWER	—	80	—	
	P <sub>OUT</sub> (1)	—	V <sub>CC</sub> = 14.4 V, THD = 10%	—	29	—	
	P <sub>OUT</sub> (2)	—	THD = 10%	23	25	—	
Total harmonic distortion	THD	—	P <sub>OUT</sub> = 5 W	—	0.005	0.07	%
Voltage gain	G <sub>V</sub>	—	V <sub>OUT</sub> = 0.775 V <sub>rms</sub>	25	26	27	dB
Channel-to-channel voltage gain	ΔG <sub>V</sub>	—	V <sub>OUT</sub> = 0.775 V <sub>rms</sub>	-1.0	0	1.0	dB
Output noise voltage	V <sub>NO</sub> (1)	—	R <sub>g</sub> = 0 Ω, DIN45405	—	60	—	μV <sub>rms</sub>
	V <sub>NO</sub> (2)	—	R <sub>g</sub> = 0 Ω, BW = 20 Hz to 20 kHz	—	55	70	
Ripple rejection ratio	R.R.	—	f <sub>rip</sub> = 100 Hz, R <sub>g</sub> = 620 Ω V <sub>rip</sub> = 0.775 V <sub>rms</sub>	50	65	—	dB
Crosstalk	C.T.	—	R <sub>g</sub> = 620 Ω V <sub>OUT</sub> = 0.775 V <sub>rms</sub>	—	80	—	dB
Output offset voltage	V <sub>OFFSET</sub>	—	—	-90	0	90	mV
Input resistance	R <sub>IN</sub>	—	—	—	90	—	kΩ
Upper cut-off frequency	F <sub>th</sub>	—	G <sub>V</sub> = 26 dB, -3 dB	—	270	—	kHz
Standby current	I <sub>SB</sub>	—	Standby condition, V <sub>4</sub> = 0, V <sub>22</sub> = 0	—	0.1	1	μA
Standby control voltage	V <sub>SB</sub> H	—	POWER: ON	2.9	—	V <sub>CC</sub>	V
	V <sub>SB</sub> L	—	POWER: OFF	0	—	0.9	

Characteristics	Symbol	Test Circuit	Test Condition	Min	Typ.	Max	Unit
Mute control voltage	$V_M H$	—	MUTE: OFF	2.9	—	$V_{CC}$	V
	$V_M L$	—	MUTE: ON, $R_1 = 47\text{ k}\Omega$	0	—	0.9	
Mute pin voltage for function switching of pin 25	$V_{M\_On}$	—	Stb = 5 V	8	—	—	V
	$V_{M\_Off}$	—		—	—	6	
Mute attenuation	ATT M	—	MUTE: ON $V_{OUT} = 7.75\text{ Vrms} \rightarrow$ Mute: OFF	85	100	—	dB

## High-Side Switch/Offset detection

Characteristics	Symbol	Test Circuit	Test Condition	Min	Typ.	Max	Unit
Maximum output current	$I_O$	—		400	—	—	mA
Voltage difference between $V_{CC}$ and output	$\Delta V_o$	—	$I_O = 400\text{ mA}$ , $+B = 9.6\text{ V}$	—	0.25	0.6	V
DC offset threshold voltage	$V_{\text{off-set}}$	—	Rpull-down = 10 k $\Omega$ , $V_4 = 5\text{ V}$ , $V_{22} = 8\text{ V}$ Out(+)-Out(-)	$\pm 2.5$	$\pm 3.0$	$\pm 3.5$	V
Pin 25 voltage (at each detector ON condition)	P25-t	—	Rpull-down = 10 k $\Omega$ , $V_4 = 5\text{ V}$ , $V_{22} = 8\text{ V}$ , $V_{\text{offset}} > \pm 3.5\text{ V}$ , (pin 25 = low)	—	0	0.5	V
Pin 25 voltage (at each detector OFF condition)	P25-f	—	Rpull-down = 10 k $\Omega$ , $V_4 = 5\text{ V}$ , $V_{22} = 8\text{ V}$ , $V_{\text{offset}} < \pm 2.5\text{ V}$ (pin 25 = high)	12	13	—	V



**Test Circuit**

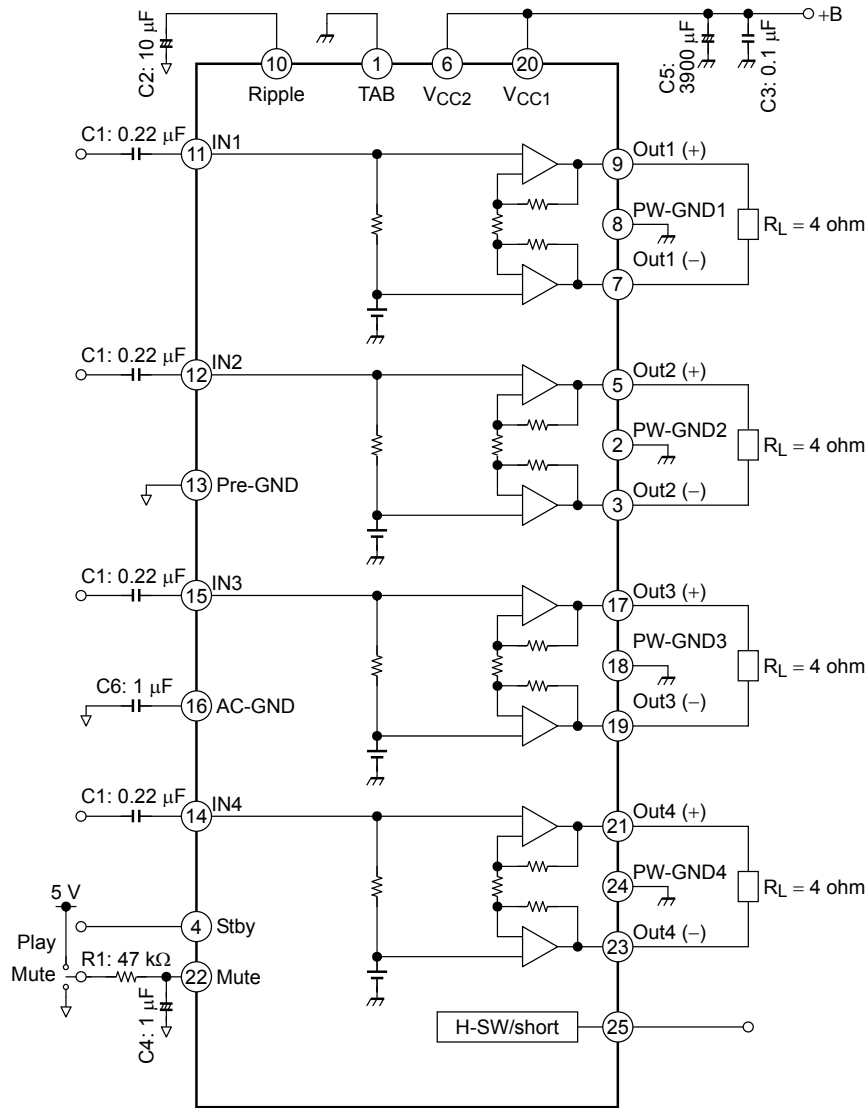

Components in the test circuit are only used to determine the device characteristics. It is not guaranteed that the system will work properly with these components.

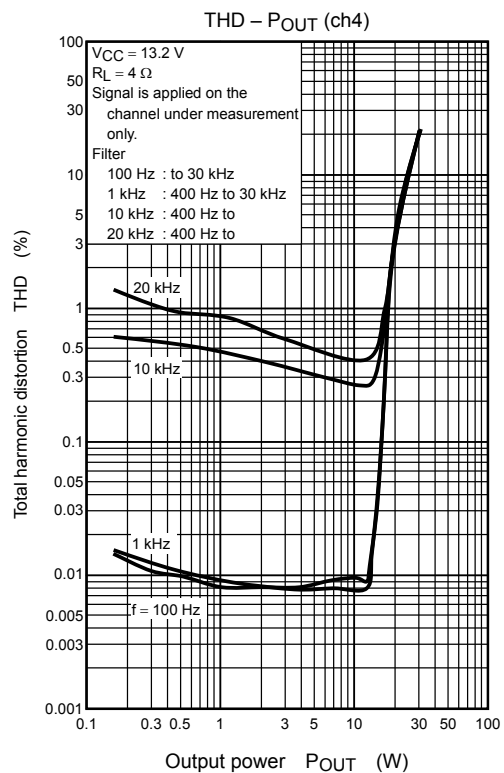
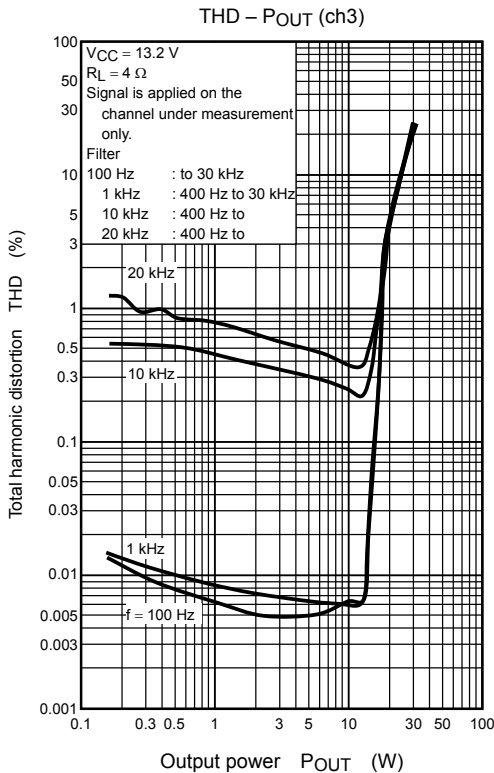
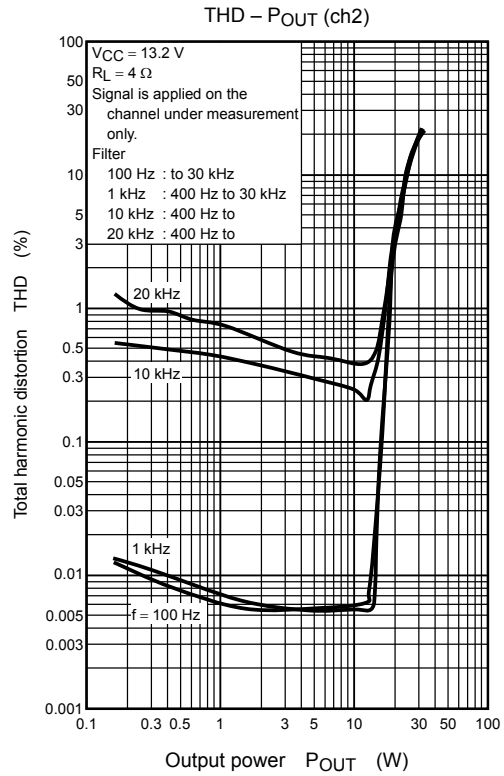
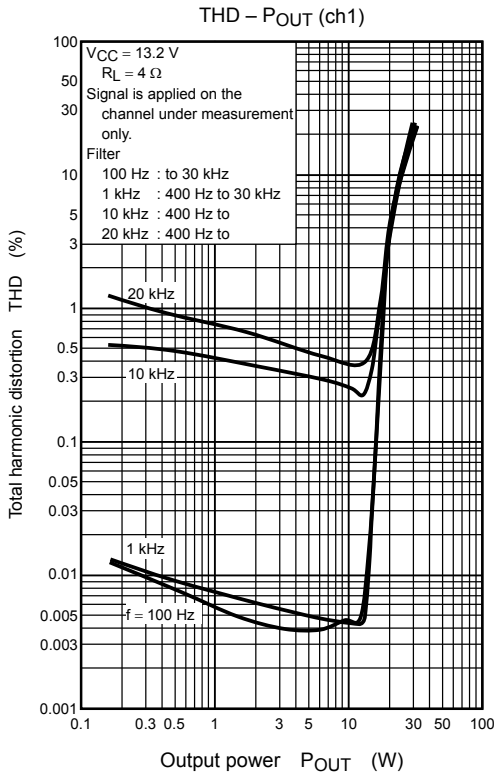

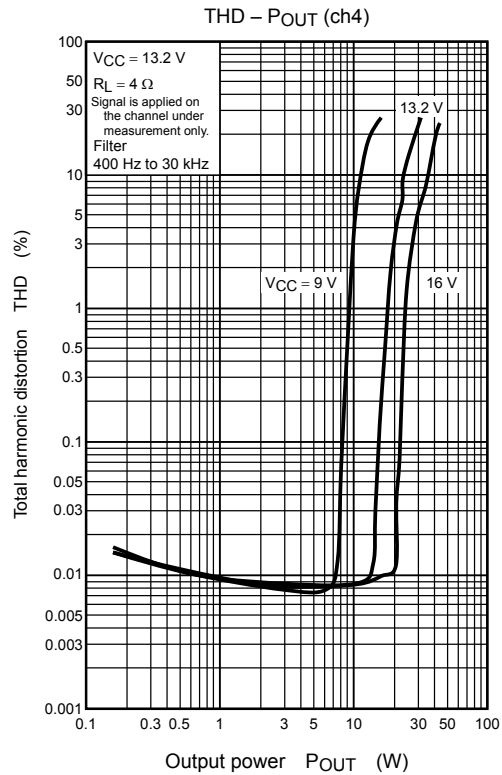
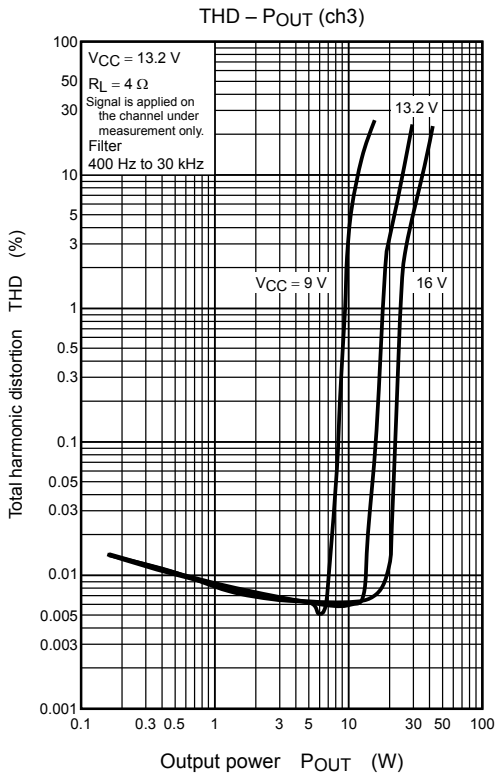
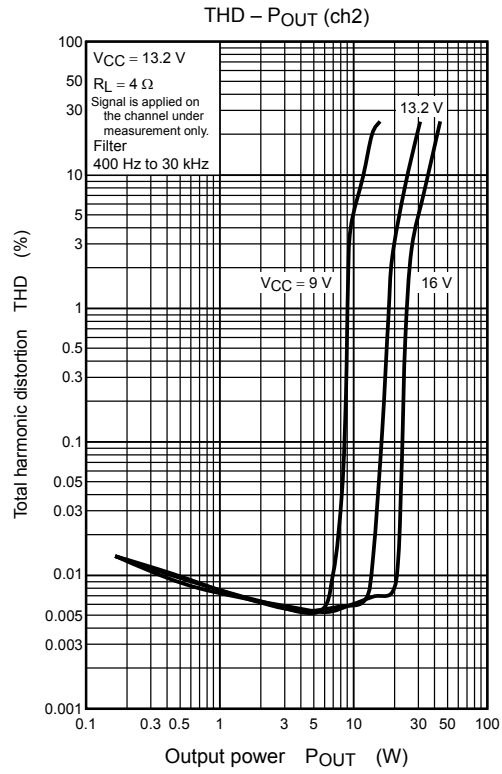
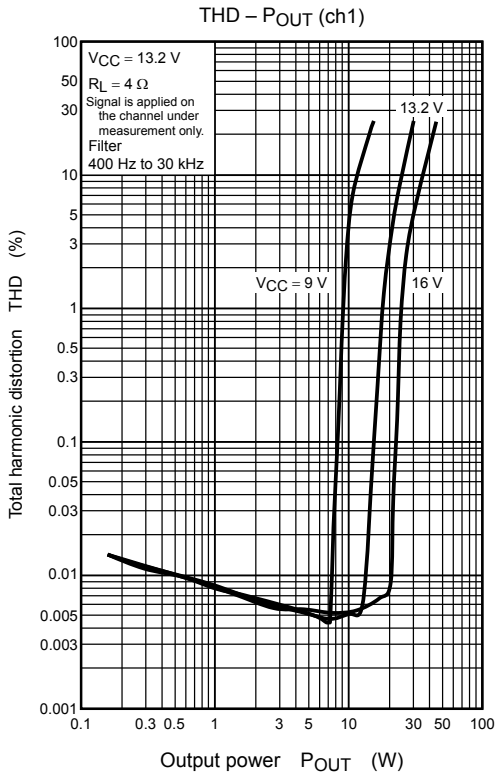

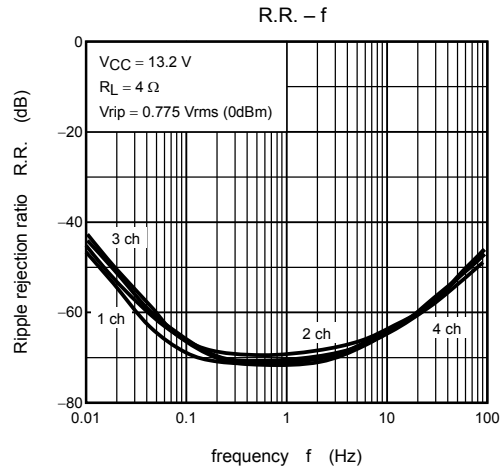
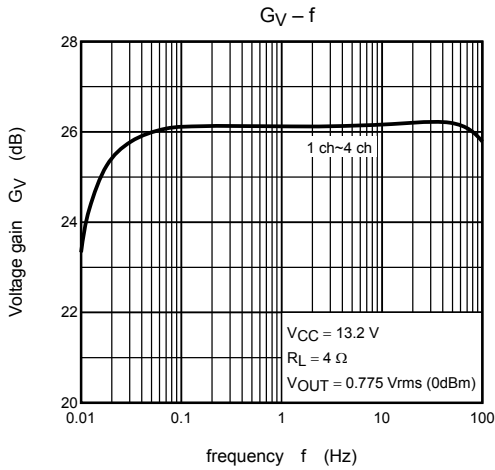
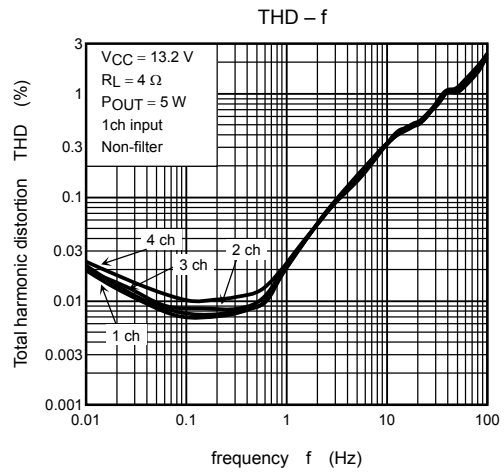
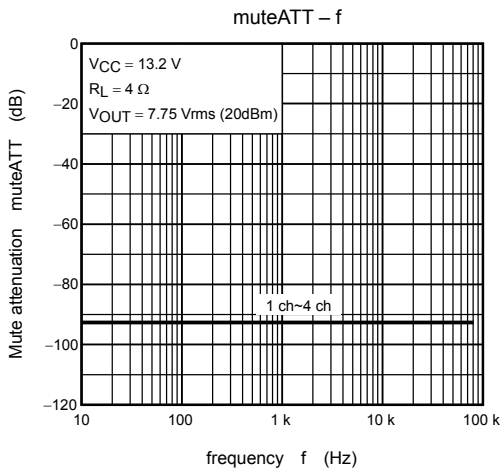

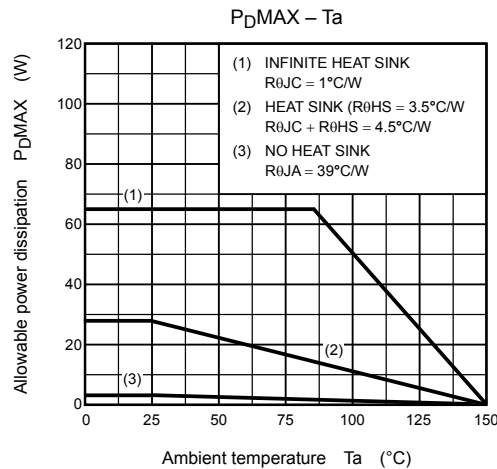
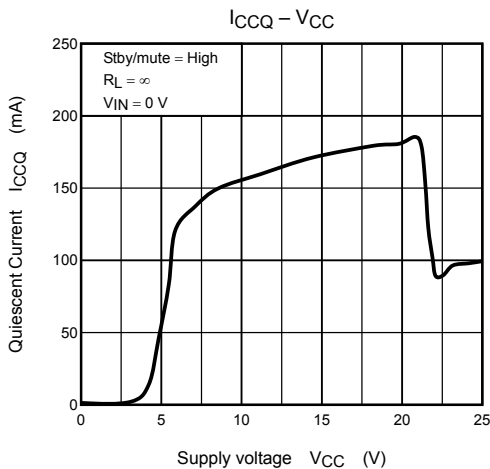
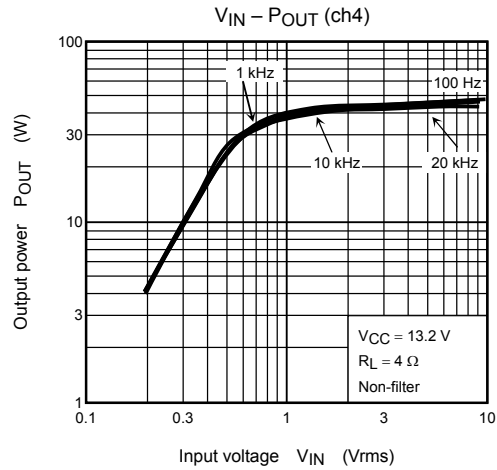
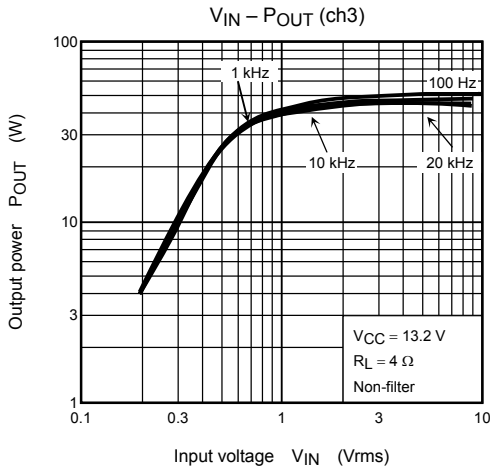
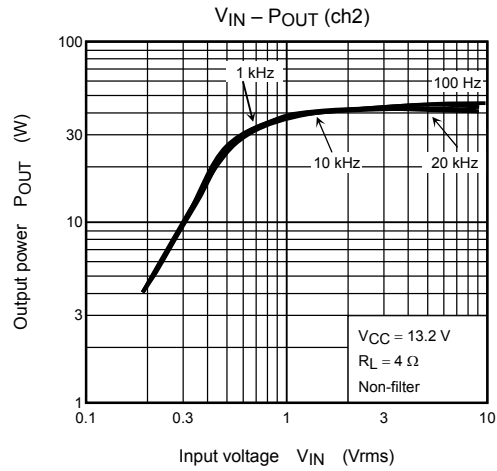
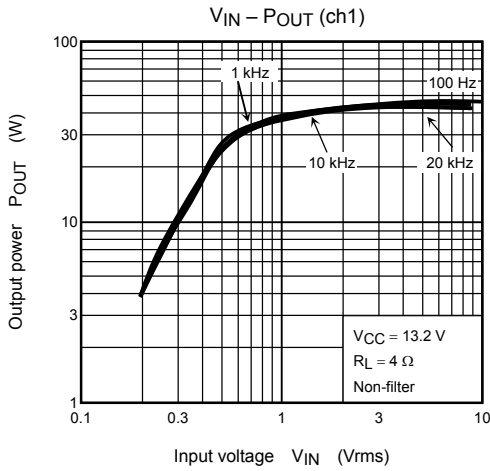

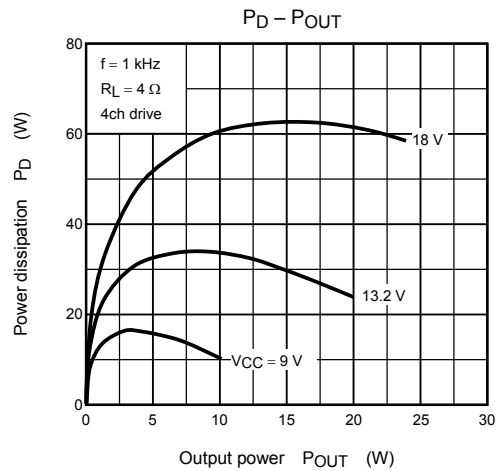
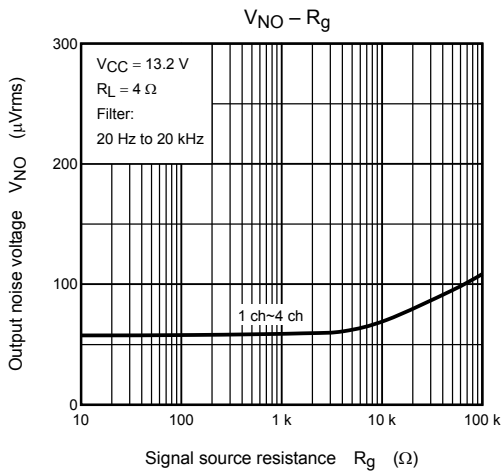
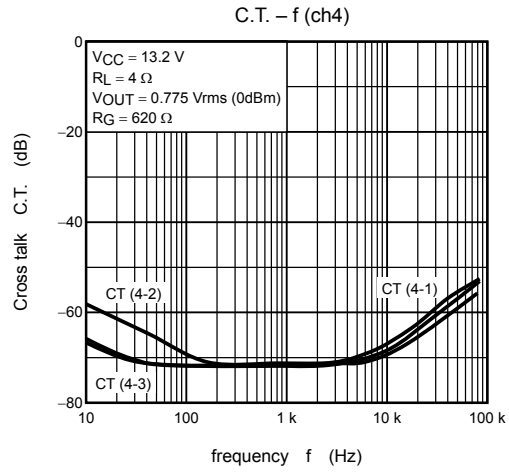
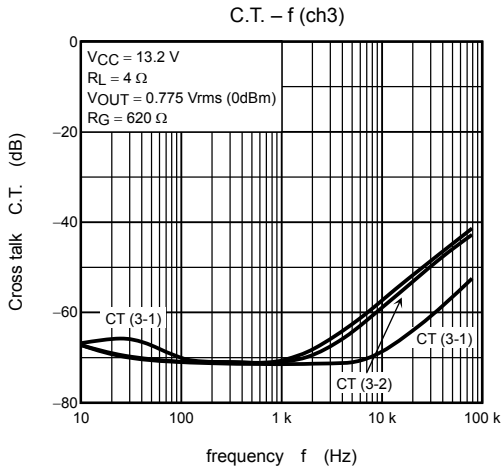
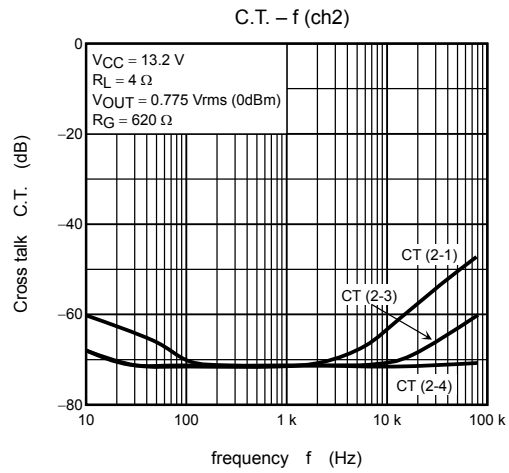
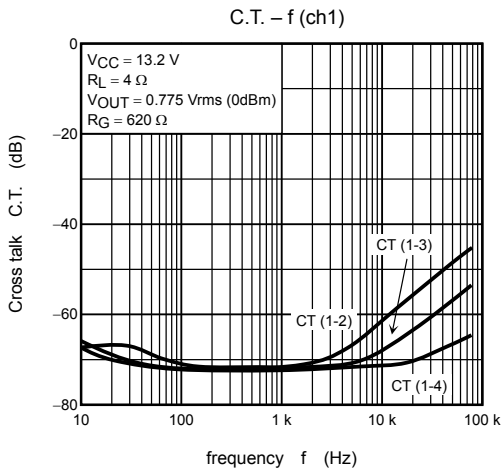

**Package Dimensions**

HZIP25-P-1.00F

Unit: mm

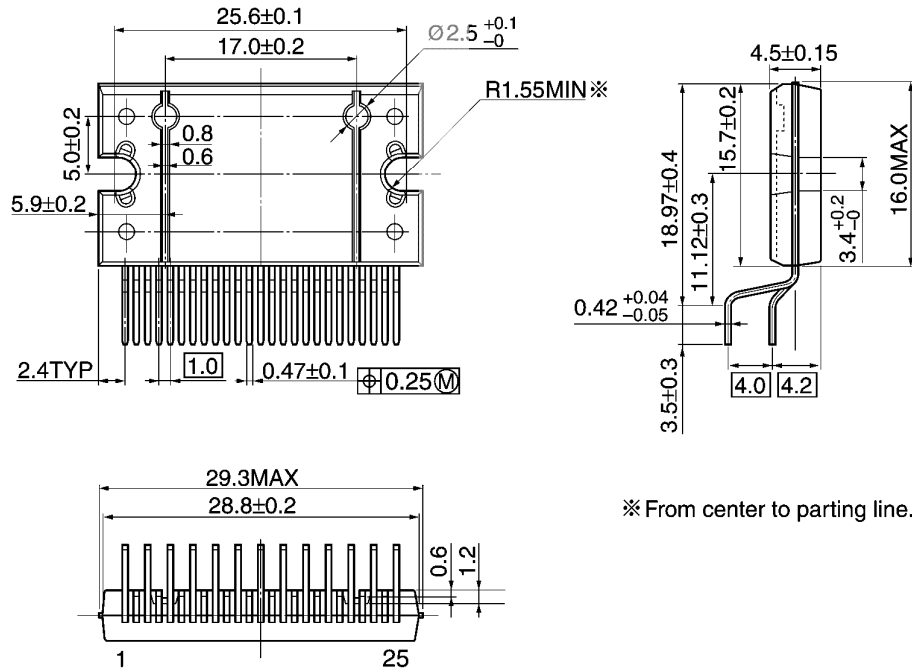

\* From center to parting line.

Weight: 7.7 g (typ.)

- Use an appropriate power supply fuse to ensure that a large current does not continuously flow in case of over current and/or IC failure. The IC will fully break down when used under conditions that exceed its absolute maximum ratings, when the wiring is routed improperly or when an abnormal pulse noise occurs from the wiring or load, causing a large current to continuously flow and the breakdown can lead smoke or ignition. To minimize the effects of the flow of a large current in case of breakdown, appropriate settings, such as fuse capacity, fusing time and insertion circuit location, are required.
- If your design includes an inductive load such as a motor coil, incorporate a protection circuit into the design to prevent device malfunction or breakdown caused by the current resulting from the inrush current at power ON or the negative current resulting from the back electromotive force at power OFF. For details on how to connect a protection circuit such as a current limiting resistor or back electromotive force adsorption diode, refer to individual IC datasheets or the IC databook. IC breakdown may cause injury, smoke or ignition.
- Use a stable power supply with ICs with built-in protection functions. If the power supply is unstable, the protection function may not operate, causing IC breakdown. IC breakdown may cause injury, smoke or ignition.
- Carefully select external components (such as inputs and negative feedback capacitors) and load components (such as speakers), for example, power amp and regulator. If there is a large amount of leakage current such as input or negative feedback condenser, the IC output DC voltage will increase. If this output voltage is connected to a speaker with low input withstand voltage, overcurrent or IC failure can cause smoke or ignition. (The over current can cause smoke or ignition from the IC itself.) In particular, please pay attention when using a Bridge Tied Load (BTL) connection type IC that inputs output DC voltage to a speaker directly.
- Over current Protection Circuit  
Over current protection circuits (referred to as current limiter circuits) do not necessarily protect ICs under all circumstances. If the Over current protection circuits operate against the over current, clear the over current status immediately. Depending on the method of use and usage conditions, such as exceeding absolute maximum ratings can cause the over current protection circuit to not operate properly or IC breakdown before operation. In addition, depending on the method of use and usage conditions, if over current continues to flow for a long time after operation, the IC may generate heat resulting in breakdown.
- Thermal Shutdown Circuit  
Thermal shutdown circuits do not necessarily protect ICs under all circumstances. If the Thermal shutdown circuits operate against the over temperature, clear the heat generation status immediately. Depending on the method of use and usage conditions, such as exceeding absolute maximum ratings can cause the thermal shutdown circuit to not operate properly or IC breakdown before operation.
- Heat Radiation Design  
When using an IC with large current flow such as power amp, regulator or driver, please design the device so that heat is appropriately radiated, not to exceed the specified junction temperature ( $T_j$ ) at any time and condition. These ICs generate heat even during normal use. An inadequate IC heat radiation design can lead to decrease in IC life, deterioration of IC characteristics or IC breakdown. In addition, please design the device taking into consideration the effect of IC heat radiation with peripheral components.
- Installation to Heat Sink  
Please install the power IC to the heat sink not to apply excessive mechanical stress to the IC. Excessive mechanical stress can lead to package cracks, resulting in a reduction in reliability or breakdown of internal IC chip. In addition, depending on the IC, the use of silicon rubber may be prohibited. Check whether the use of silicon rubber is prohibited for the IC you intend to use, or not. For details of power IC heat radiation design and heat sink installation, refer to individual technical datasheets or IC databooks.

About solderability, following conditions were confirmed

- Solderability
  - (1) Use of Sn-37Pb solder Bath
    - solder bath temperature = 230°C
    - dipping time = 5 seconds
    - the number of times = once
    - use of R-type flux
  - (2) Use of Sn-3.0Ag-0.5Cu solder Bath
    - solder bath temperature = 245°C
    - dipping time = 5 seconds
    - the number of times = once
    - use of R-type flux



## RESTRICTIONS ON PRODUCT USE

- Toshiba Corporation, and its subsidiaries and affiliates (collectively "TOSHIBA"), reserve the right to make changes to the information in this document, and related hardware, software and systems (collectively "Product") without notice.
- This document and any information herein may not be reproduced without prior written permission from TOSHIBA. Even with TOSHIBA's written permission, reproduction is permissible only if reproduction is without alteration/omission.
- Though TOSHIBA works continually to improve Product's quality and reliability, Product can malfunction or fail. Customers are responsible for complying with safety standards and for providing adequate designs and safeguards for their hardware, software and systems which minimize risk and avoid situations in which a malfunction or failure of Product could cause loss of human life, bodily injury or damage to property, including data loss or corruption. Before creating and producing designs and using, customers must also refer to and comply with (a) the latest versions of all relevant TOSHIBA information, including without limitation, this document, the specifications, the data sheets and application notes for Product and the precautions and conditions set forth in the "TOSHIBA Semiconductor Reliability Handbook" and (b) the instructions for the application that Product will be used with or for. Customers are solely responsible for all aspects of their own product design or applications, including but not limited to (a) determining the appropriateness of the use of this Product in such design or applications; (b) evaluating and determining the applicability of any information contained in this document, or in charts, diagrams, programs, algorithms, sample application circuits, or any other referenced documents; and (c) validating all operating parameters for such designs and applications. **TOSHIBA ASSUMES NO LIABILITY FOR CUSTOMERS' PRODUCT DESIGN OR APPLICATIONS.**
- Product is intended for use in general electronics applications (e.g., computers, personal equipment, office equipment, measuring equipment, industrial robots and home electronics appliances) or for specific applications as expressly stated in this document. Product is neither intended nor warranted for use in equipment or systems that require extraordinarily high levels of quality and/or reliability and/or a malfunction or failure of which may cause loss of human life, bodily injury, serious property damage or serious public impact ("Unintended Use"). Unintended Use includes, without limitation, equipment used in nuclear facilities, equipment used in the aerospace industry, medical equipment, equipment used for automobiles, trains, ships and other transportation, traffic signaling equipment, equipment used to control combustions or explosions, safety devices, elevators and escalators, devices related to electric power, and equipment used in finance-related fields. Do not use Product for Unintended Use unless specifically permitted in this document.
- Do not disassemble, analyze, reverse-engineer, alter, modify, translate or copy Product, whether in whole or in part.
- Product shall not be used for or incorporated into any products or systems whose manufacture, use, or sale is prohibited under any applicable laws or regulations.
- The information contained herein is presented only as guidance for Product use. No responsibility is assumed by TOSHIBA for any infringement of patents or any other intellectual property rights of third parties that may result from the use of Product. No license to any intellectual property right is granted by this document, whether express or implied, by estoppel or otherwise.
- **ABSENT A WRITTEN SIGNED AGREEMENT, EXCEPT AS PROVIDED IN THE RELEVANT TERMS AND CONDITIONS OF SALE FOR PRODUCT, AND TO THE MAXIMUM EXTENT ALLOWABLE BY LAW, TOSHIBA (1) ASSUMES NO LIABILITY WHATSOEVER, INCLUDING WITHOUT LIMITATION, INDIRECT, CONSEQUENTIAL, SPECIAL, OR INCIDENTAL DAMAGES OR LOSS, INCLUDING WITHOUT LIMITATION, LOSS OF PROFITS, LOSS OF OPPORTUNITIES, BUSINESS INTERRUPTION AND LOSS OF DATA, AND (2) DISCLAIMS ANY AND ALL EXPRESS OR IMPLIED WARRANTIES AND CONDITIONS RELATED TO SALE, USE OF PRODUCT, OR INFORMATION, INCLUDING WARRANTIES OR CONDITIONS OF MERCHANTABILITY, FITNESS FOR A PARTICULAR PURPOSE, ACCURACY OF INFORMATION, OR NONINFRINGEMENT.**
- Do not use or otherwise make available Product or related software or technology for any military purposes, including without limitation, for the design, development, use, stockpiling or manufacturing of nuclear, chemical, or biological weapons or missile technology products (mass destruction weapons). Product and related software and technology may be controlled under the Japanese Foreign Exchange and Foreign Trade Law and the U.S. Export Administration Regulations. Export and re-export of Product or related software or technology are strictly prohibited except in compliance with all applicable export laws and regulations.
- Please contact your TOSHIBA sales representative for details as to environmental matters such as the RoHS compatibility of Product. Please use Product in compliance with all applicable laws and regulations that regulate the inclusion or use of controlled substances, including without limitation, the EU RoHS Directive. TOSHIBA assumes no liability for damages or losses occurring as a result of noncompliance with applicable laws and regulations.