

NLX1G57

Configurable Multifunction Gate

The NLX1G57 MiniGate™ is an advanced high-speed CMOS multifunction gate. The device allows the user to choose logic functions AND, OR, NAND, NOR, XNOR, INVERT and BUFFER. The device has Schmitt-trigger inputs, thereby enhancing noise immunity.

The NLX1G57 input and output structures provide protection when voltages up to 7.0 V are applied, regardless of the supply voltage.

Features

- High Speed: $t_{PD} = 3.2 \text{ ns (Typ) @ } V_{CC} = 5.0 \text{ V}$
- Low Power Dissipation: $I_{CC} = 1 \mu\text{A (Maximum) at } T_A = 25^\circ\text{C}$
- Power Down Protection Provided on inputs
- Balanced Propagation Delays
- Overvoltage Tolerant (OVT) Input and Output Pins
- Ultra-Small Packages
- This is a Pb-Free Device



ON Semiconductor®

<http://onsemi.com>

MARKING DIAGRAMS

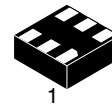

ULLGA6
1.0 x 1.0
CASE 613AD

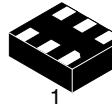

ULLGA6
1.2 x 1.0
CASE 613AE

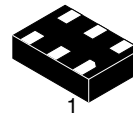

ULLGA6
1.45 x 1.0
CASE 613AF



D = Specific Device Code
M = Date Code

PIN ASSIGNMENTS

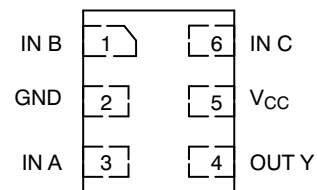

(Top View)

ORDERING INFORMATION

See detailed ordering and shipping information in the package dimensions section on page 7 of this data sheet.

NLX1G57

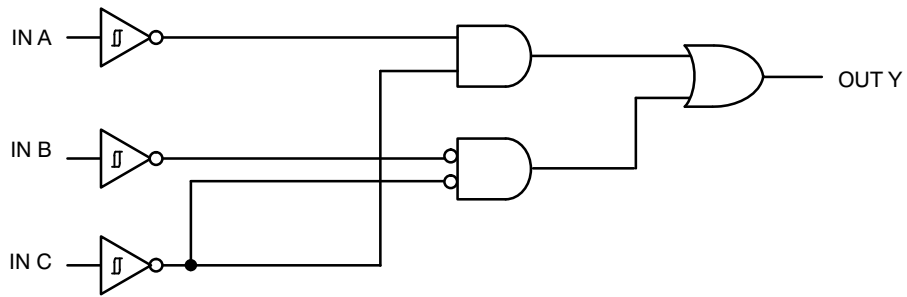

Figure 1. Function Diagram

PIN ASSIGNMENT

1	IN B
2	GND
3	IN A
4	OUT Y
5	V _{CC}
6	IN C

FUNCTION TABLE*

Input			Output
A	B	C	Y
L	L	L	H
L	L	H	L
L	H	L	H
L	H	H	H
H	L	L	L
H	L	H	L
H	H	L	L
H	H	H	H

*To select a logic function, please refer to "Logic Configurations section".

LOGIC CONFIGURATIONS

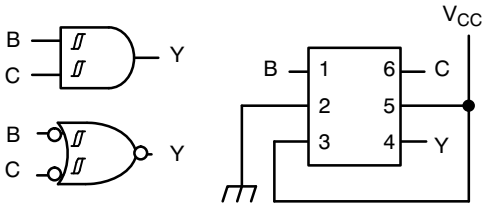

Figure 2. 2-Input AND (When A = "H")

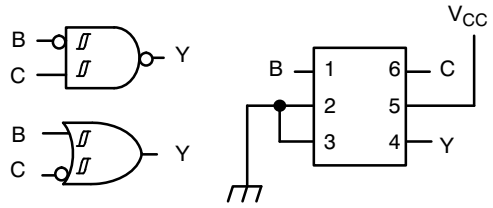

Figure 3. 2-Input NAND with input B inverted (When A = "L")

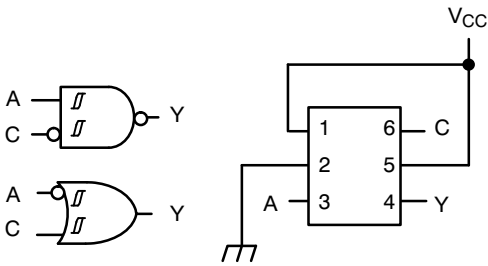

Figure 4. 2-Input NAND with Input C Inverted (When B = "H")

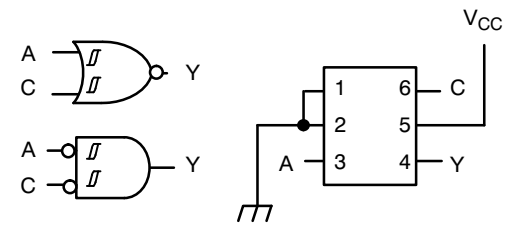

Figure 5. 2-Input NOR (When B = "L")

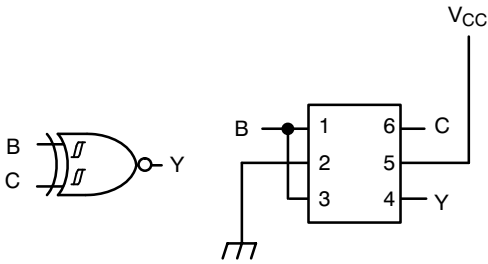

Figure 6. 2-Input XNOR (When A = B)

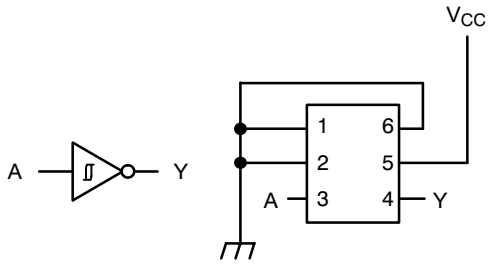

Figure 7. Inverter (When B = C = "L")

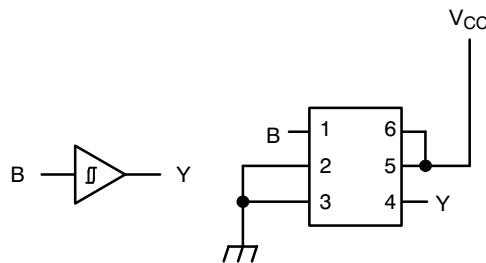

Figure 8. Buffer (When A = "L" and C = "H")

NLX1G57

MAXIMUM RATINGS

Symbol	Parameter	Value	Unit
V _{CC}	DC Supply Voltage	-0.5 to +7.0	V
V _{IN}	DC Input Voltage	-0.5 to +7.0	V
V _{OUT}	DC Output Voltage	-0.5 to +7.0	V
I _{IK}	DC Input Diode Current V _{IN} < GND	-50	mA
I _{OK}	DC Output Diode Current V _{OUT} < GND	-50	mA
I _O	DC Output Source/Sink Current	± 50	mA
I _{CC}	DC Supply Current Per Supply Pin	± 100	mA
I _{GND}	DC Ground Current per Ground Pin	± 100	mA
T _{STG}	Storage Temperature Range	-65 to +150	°C
T _L	Lead Temperature, 1 mm from Case for 10 Seconds	260	°C
T _J	Junction Temperature Under Bias	150	°C
MSL	Moisture Sensitivity	Level 1	
F _R	Flammability Rating Oxygen Index: 28 to 34	UL 94 V-0 @ 0.125 in	
V _{ESD}	ESD Withstand Voltage Human Body Model (Note 2) Machine Model (Note 3) Charged Device Model (Note 4)	>2000 >200 N/A	V
I _{LATCHUP}	Latchup Performance Above V _{CC} and Below GND at 125°C (Note 5)	± 500	mA

Stresses exceeding Maximum Ratings may damage the device. Maximum Ratings are stress ratings only. Functional operation above the Recommended Operating Conditions is not implied. Extended exposure to stresses above the Recommended Operating Conditions may affect device reliability.

1. Measured with minimum pad spacing on an FR4 board, using 10 mm by 1 inch, 2 ounce copper trace no air flow.
2. Tested to EIA/JESD22-A114-A.
3. Tested to EIA/JESD22-A115-A.
4. Tested to JESD22-C101-A.
5. Tested to EIA/JESD78.

RECOMMENDED OPERATING CONDITIONS

Symbol	Parameter	Min	Max	Unit
V _{CC}	Positive DC Supply Voltage	1.65	5.5	V
V _{IN}	Digital Input Voltage	0	5.5	V
V _{OUT}	Output Voltage	0	5.5	V
T _A	Operating Free-Air Temperature	-55	+125	°C
Δt/ΔV	Input Transition Rise or Fall Rate V _{CC} = 2.5 V ± 0.2 V V _{CC} = 3.3 V ± 0.3 V V _{CC} = 5.0 V ± 0.5 V	0 0 0	No Limit No Limit No Limit	nS/V

NLX1G57

DC ELECTRICAL CHARACTERISTICS

Symbol	Parameter	Conditions	V _{CC} (V)	T _A = 25°C			T _A ≤ +85°C		T _A = -55°C to +125°C		Unit
				Min	Typ	Max	Min	Max	Min	Max	
V _{T+}	Positive Threshold Voltage		1.65	0.79		1.16		1.16		1.16	V
			2.3	1.11		1.56		1.56		1.56	
			3.0	1.5		1.87		1.87		1.87	
			4.5	2.16		2.74		2.74		2.74	
			5.5	2.61		3.33		3.33		3.33	
V _{T-}	Negative Threshold Voltage		1.65	0.35		0.62	0.35		0.35		V
			2.3	0.58		0.87	0.58		0.58		
			3.0	0.84		1.19	0.84		0.84		
			4.5	1.41		1.9	1.41		1.41		
			5.5	1.78		2.29	1.78		1.78		
V _H	Hysteresis Voltage		1.65	0.30		0.62	0.30	0.62	0.30	0.62	V
			2.3	0.40		0.8	0.40	0.8	0.40	0.8	
			3.0	0.53		0.87	0.53	0.87	0.53	0.87	
			4.5	0.71		1.04	0.71	1.04	0.71	1.04	
			5.5	0.8		1.2	0.8	1.2	0.8	1.2	
V _{OH}	Minimum High-Level Output Voltage	V _{IN} = V _{T-MIN} or V _{T+MAX} I _{OH} = -50 μA	1.65 - 5.5	V _{CC} - 0.1			V _{CC} - 0.1		V _{CC} - 0.1		V
		V _{IN} = V _{T-MIN} or V _{T+MAX}									
		I _{OH} = -4 mA	1.65	1.2			1.2		1.2		
		I _{OH} = -8 mA	2.3	1.9			1.9		1.9		
		I _{OH} = -16 mA	3.0	2.4			2.4		2.4		
		I _{OH} = -24 mA	3.0	2.3			2.3		2.3		
		I _{OH} = -32 mA	4.5	3.8			3.8		3.8		
V _{OL}	Maximum Low-Level Output Voltage	V _{IN} = V _{T-MIN} or V _{T+MAX} I _{OL} = 50 μA	1.65 - 5.5			0.1		0.1		0.1	V
		V _{IN} = V _{T-MIN} or V _{T+MAX}									
		I _{OL} = 4 mA	1.65			0.45		0.45		0.45	
		I _{OL} = 8 mA	2.3			0.3		0.3		0.3	
		I _{OL} = 16 mA	3.0			0.4		0.4		0.4	
		I _{OL} = 24 mA	3.0			0.55		0.55		0.55	
		I _{OL} = 32 mA	4.5			0.55		0.55		0.55	
I _{IN}	Input Leakage Current	0 ≤ V _{IN} ≤ 5.5 V	0 to 5.5			±0.1		±1.0		μA	
I _{CC}	Quiescent Supply Current	0 ≤ V _{IN} ≤ V _{CC}	5.5			1.0		10		μA	

NLX1G57

AC ELECTRICAL CHARACTERISTICS (Input $t_r = t_f = 3.0$ ns)

Symbol	Parameter	V_{CC} (V)	Test Condition	$T_A = 25^\circ\text{C}$			$T_A \leq +85^\circ\text{C}$		$T_A = -55^\circ\text{C}$ to $+125^\circ\text{C}$		Unit
				Min	Typ	Max	Min	Max	Min	Max	
t_{PLH} , t_{PHL}	Propagation Delay, Any Input to Output Y (See Test Circuit)	1.65 - 1.95		3.2	8.5	14.4	3.2	14.4	3.2	14.4	ns
		2.3 - 2.7		2	4.9	8.3	2	8.3	2	8.3	
		3.0 - 3.6		1.5	3.8	6.3	1.5	6.3	1.5	6.3	
		4.5 - 5.5		1.1	3.2	5.1	1.1	5.1	1.1	5.1	
C_{IN}	Input Capacitance				3.5						pF
C_{PD}	Power Dissipation Capacitance (Note 6)	5.0	$f = 10$ MHz		22						pF

6. C_{PD} is defined as the value of the internal equivalent capacitance which is calculated from the dynamic operating current consumption without load. Average operating current can be obtained by the equation $I_{CC(OPR)} = C_{PD} \cdot V_{CC} \cdot f_{in} + I_{CC}$. C_{PD} is used to determine the no-load dynamic power consumption: $P_D = C_{PD} \cdot V_{CC}^2 \cdot f_{in} + I_{CC} \cdot V_{CC}$.

TEST CIRCUIT AND VOLTAGE WAVEFORMS

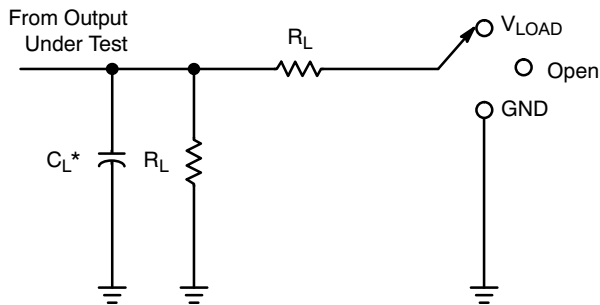

Test	S1
t_{PLH}/t_{PHL}	Open
t_{PLZ}/t_{PZL}	V_{LOAD}
t_{PHZ}/t_{PZH}	GND

* C_L includes probes and jig capacitance.

Figure 9. Load Circuit

V_{CC}	Inputs		V_M	V_{LOAD}	C_L	R_L	V_A
	V_I	t_r/t_f					
$1.8\text{ V} \pm 0.15\text{ V}$	V_{CC}	$\leq 2\text{ ns}$	$V_{CC}/2$	$2 \times V_{CC}$	30 pF	1 k Ω	0.15 V
$2.5\text{ V} \pm 0.2\text{ V}$	V_{CC}	$\leq 2\text{ ns}$	$V_{CC}/2$	$2 \times V_{CC}$	30 pF	500 Ω	0.15 V
$3.3\text{ V} \pm 0.3\text{ V}$	3 V	$\leq 2.5\text{ ns}$	1.5 V	6 V	50 pF	500 Ω	0.3 V
$5.5\text{ V} \pm 0.5\text{ V}$	V_{CC}	$\leq 2.5\text{ ns}$	$V_{CC}/2$	$2 \times V_{CC}$	50 pF	500 Ω	0.3 V

NLX1G57

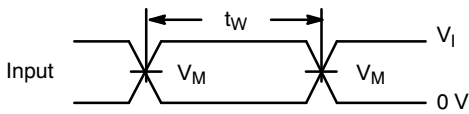

Figure 10. Voltage Waveforms Pulse Duration

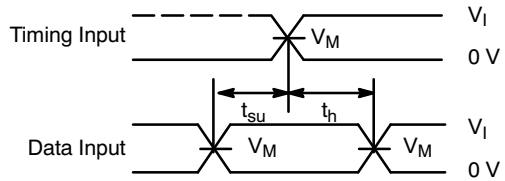

Figure 11. Voltage Waveforms Setup and Hold Times

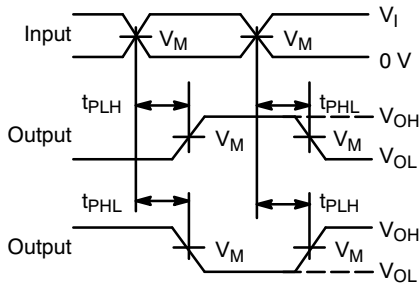

Figure 12. Voltage Waveforms Propagation Delay Times Inverting and Noninverting Outputs

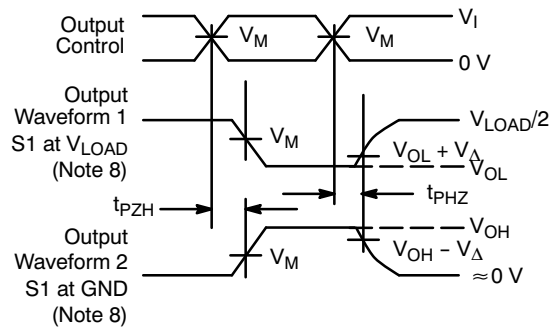

Figure 13. Voltage Waveforms Enable and Disable Times Low- and High-Level Enabling

7. Waveform 1 is for an output with internal conditions such that the output is low, except when disabled by the output control.
8. Waveform 2 is for an output with internal conditions such that the output is high, except when disabled by the output control.
9. All input pulses are supplied by generators having the following characteristics: $PRR \leq 10 \text{ MHz}$, $Z_O = 50 \Omega$.
10. The outputs are measured one at a time, with one transition per measurement.
11. All parameters are waveforms are not applicable to all devices.

ORDERING INFORMATION

Device	Package	Shipping†
NLX1G57AMX1TCG	ULLGA6 - 0.5P (Pb-Free)	3000 / Tape & Reel
NLX1G57BMX1TCG	ULLGA6 - 0.4P (Pb-Free)	3000 / Tape & Reel
NLX1G57CMX1TCG	ULLGA6 - 0.35P (Pb-Free)	3000 / Tape & Reel

†For information on tape and reel specifications, including part orientation and tape sizes, please refer to our Tape and Reel Packaging Specifications Brochure, BRD8011/D.

NLX1G57

PACKAGE DIMENSIONS

ULLGA6, 1.0x1.0, 0.35P
CASE 613AD-01
ISSUE A

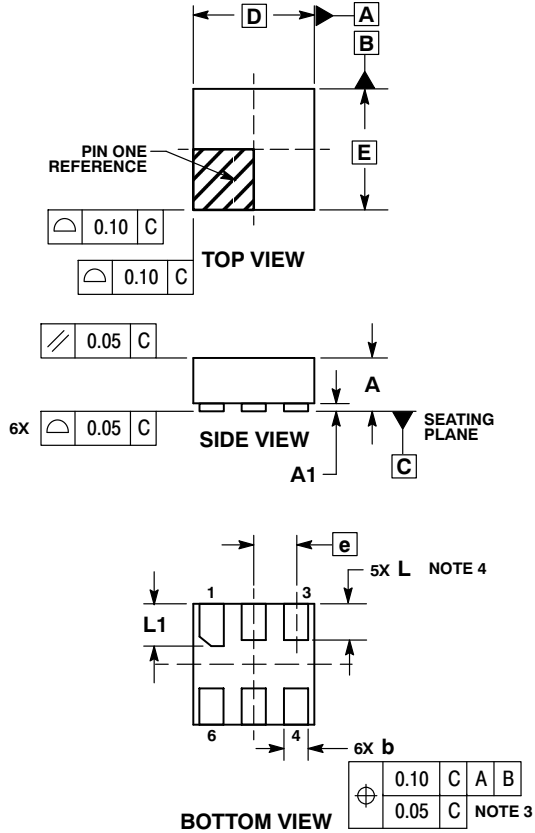

NOTES:

1. DIMENSIONING AND TOLERANCING PER ASME Y14.5M, 1994.
2. CONTROLLING DIMENSION: MILLIMETERS.
3. DIMENSION b APPLIES TO PLATED TERMINAL AND IS MEASURED BETWEEN 0.15 AND 0.30 mm FROM THE TERMINAL TIP.
4. A MAXIMUM OF 0.05 PULL BACK OF THE PLATED TERMINAL FROM THE EDGE OF THE PACKAGE IS ALLOWED.

MILLIMETERS		
DIM	MIN	MAX
A	---	0.40
A1	0.00	0.05
b	0.12	0.22
D	1.00 BSC	
E	1.00 BSC	
e	0.35 BSC	
L	0.25	0.35
L1	0.30	0.40

**MOUNTING FOOTPRINT
SOLDERMASK DEFINED***

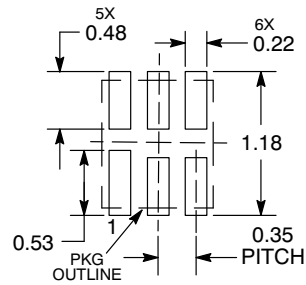

DIMENSIONS: MILLIMETERS

*For additional information on our Pb-Free strategy and soldering details, please download the ON Semiconductor Soldering and Mounting Techniques Reference Manual, SOLDERRM/D.

NLX1G57

PACKAGE DIMENSIONS

ULLGA6, 1.2x1.0, 0.4P
CASE 613AE-01
ISSUE A

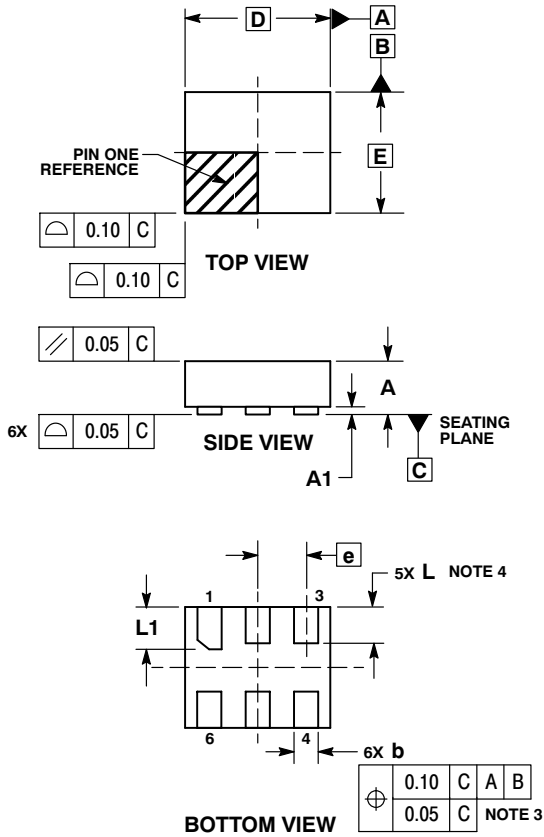

NOTES:

1. DIMENSIONING AND TOLERANCING PER ASME Y14.5M, 1994.
2. CONTROLLING DIMENSION: MILLIMETERS.
3. DIMENSION b APPLIES TO PLATED TERMINAL AND IS MEASURED BETWEEN 0.15 AND 0.30 mm FROM THE TERMINAL TIP.
4. A MAXIMUM OF 0.05 PULL BACK OF THE PLATED TERMINAL FROM THE EDGE OF THE PACKAGE IS ALLOWED.

MILLIMETERS			
DIM	MIN	MAX	
A	---	0.40	
A1	0.00	0.05	
b	0.15	0.25	
D	1.20 BSC		
E	1.00 BSC		
e	0.40 BSC		
L	0.25	0.35	
L1	0.35	0.45	

**MOUNTING FOOTPRINT
SOLDERMASK DEFINED***

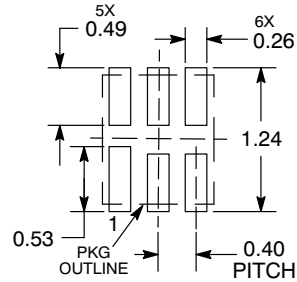

DIMENSIONS: MILLIMETERS

*For additional information on our Pb-Free strategy and soldering details, please download the ON Semiconductor Soldering and Mounting Techniques Reference Manual, SOLDERRM/D.

NLX1G57

PACKAGE DIMENSIONS

ULLGA6, 1.45x1.0, 0.5P
CASE 613AF-01
ISSUE A

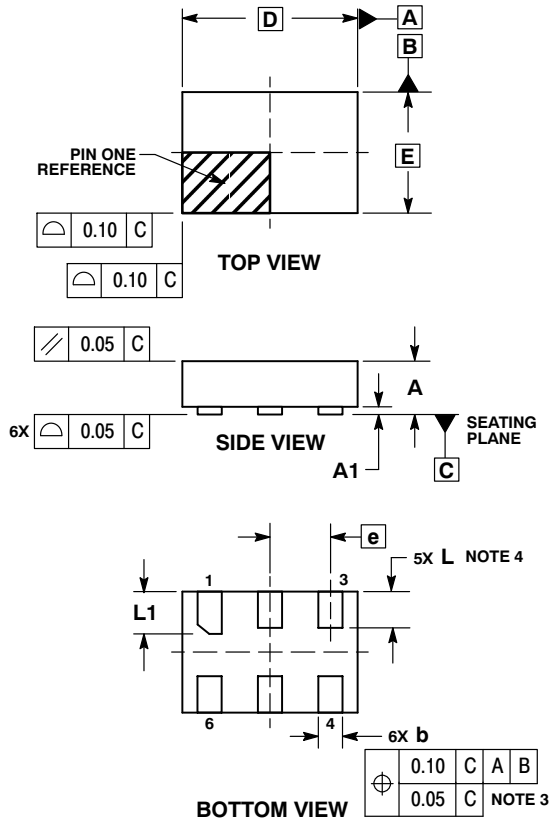

NOTES:

1. DIMENSIONING AND TOLERANCING PER ASME Y14.5M, 1994.
2. CONTROLLING DIMENSION: MILLIMETERS.
3. DIMENSION b APPLIES TO PLATED TERMINAL AND IS MEASURED BETWEEN 0.15 AND 0.30 mm FROM THE TERMINAL TIP.
4. A MAXIMUM OF 0.05 PULL BACK OF THE PLATED TERMINAL FROM THE EDGE OF THE PACKAGE IS ALLOWED.

MILLIMETERS		
DIM	MIN	MAX
A	---	0.40
A1	0.00	0.05
b	0.15	0.25
D	1.45 BSC	
E	1.00 BSC	
e	0.50 BSC	
L	0.25	0.35
L1	0.30	0.40

MOUNTING FOOTPRINT SOLDERMASK DEFINED*

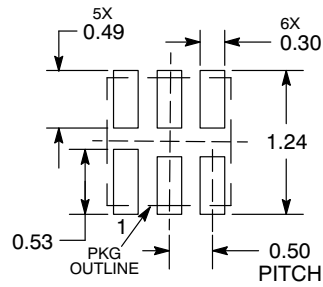

DIMENSIONS: MILLIMETERS

*For additional information on our Pb-Free strategy and soldering details, please download the ON Semiconductor Soldering and Mounting Techniques Reference Manual, SOLDERRM/D.

MiniGate is a trademark of Semiconductor Components Industries, LLC (SCILLC).

ON Semiconductor and are registered trademarks of Semiconductor Components Industries, LLC (SCILLC). SCILLC reserves the right to make changes without further notice to any products herein. SCILLC makes no warranty, representation or guarantee regarding the suitability of its products for any particular purpose, nor does SCILLC assume any liability arising out of the application or use of any product or circuit, and specifically disclaims any and all liability, including without limitation special, consequential or incidental damages. "Typical" parameters which may be provided in SCILLC data sheets and/or specifications can and do vary in different applications and actual performance may vary over time. All operating parameters, including "Typicals" must be validated for each customer application by customer's technical experts. SCILLC does not convey any license under its patent rights nor the rights of others. SCILLC products are not designed, intended, or authorized for use as components in systems intended for surgical implant into the body, or other applications intended to support or sustain life, or for any other application in which the failure of the SCILLC product could create a situation where personal injury or death may occur. Should Buyer purchase or use SCILLC products for any such unintended or unauthorized application, Buyer shall indemnify and hold SCILLC and its officers, employees, subsidiaries, affiliates, and distributors harmless against all claims, costs, damages, and expenses, and reasonable attorney fees arising out of, directly or indirectly, any claim of personal injury or death associated with such unintended or unauthorized use, even if such claim alleges that SCILLC was negligent regarding the design or manufacture of the part. SCILLC is an Equal Opportunity/Affirmative Action Employer. This literature is subject to all applicable copyright laws and is not for resale in any manner.

PUBLICATION ORDERING INFORMATION

LITERATURE FULFILLMENT:
Literature Distribution Center for ON Semiconductor
P.O. Box 5163, Denver, Colorado 80217 USA
Phone: 303-675-2175 or 800-344-3860 Toll Free USA/Canada
Fax: 303-675-2176 or 800-344-3867 Toll Free USA/Canada
Email: orderlit@onsemi.com

N. American Technical Support: 800-282-9855 Toll Free
USA/Canada
Europe, Middle East and Africa Technical Support:
Phone: 421 33 790 2910
Japan Customer Focus Center
Phone: 81-3-5773-3850

ON Semiconductor Website: www.onsemi.com
Order Literature: <http://www.onsemi.com/orderlit>
For additional information, please contact your local Sales Representative

NLX1G57/D