

# TC7SBD385FU

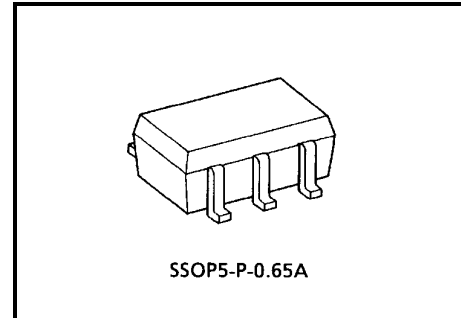
## Single Bus Switch with Level Shifting

The TC7SBD385FU provides single bit of high-speed TTL-compatible switching. The low on resistance of the switch allows connections to be made with minimal propagation delay.

The device is organized as just 1-bit low-impedance switch with output-enable (OE) input. When OE is high, the switch is on and data can flow from port A to port B, or vice versa. When OE is low, the switch is open and a high-impedance state exists between the two ports.

The internal diode which adds to power supply line is enable to realize the shift of signal level from 5 V to 3.3 V. (Note 1)

All inputs are equipped with protection circuits against static discharge.



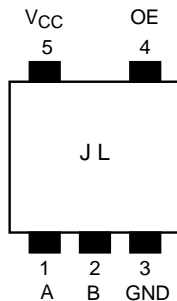
Weight: 0.006 g (typ.)

### Features

- Operating voltage:  $V_{CC} = 4.5\sim 5.5\text{ V}$
- High speed operation:  $t_{pd} = 0.25\text{ ns (max)}$
- Low on resistance:  $R_{ON} = 5\ \Omega\text{ (typ.)}$
- ESD performance: Machine model  $> \pm 200\text{ V}$   
Human body model  $> \pm 2000\text{ V}$
- TTL level input (control input)
- Package: USV

Note 1: In case that over-shoot noise is detected, this device should be used with clamp diode to prevent the next stage device from over-stress.

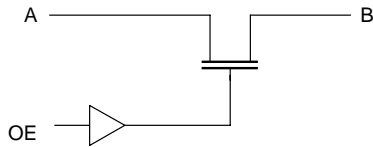
### Pin Assignment (top view)



## Truth Table

Input	Function
OE	
L	Disconnect
H	A port = B port

## System Diagram



## Maximum Ratings

Characteristics	Symbol	Rating	Unit
Power supply range	$V_{CC}$	-0.5~7.0	V
DC input voltage	$V_{IN}$	-0.5~7.0	V
DC switch voltage	$V_S$	-0.5~7.0	V
Input diode current	$I_{IK}$	-50	mA
Continuous channel current	$I_S$	128	mA
Power dissipation	$P_D$	200	mW
DC $V_{CC}/GND$ current	$I_{CC}/I_{GND}$	$\pm 100$	mA
Storage temperature	$T_{stg}$	-65~150	$^{\circ}C$

## Recommended Operating Conditions

Characteristics	Symbol	Rating	Unit
Supply voltage	$V_{CC}$	4.5~5.5	V
Input voltage	$V_{IN}$	0~5.5	V
Switch voltage	$V_S$	0~5.5	V
Operating temperature	$T_{opr}$	-40~85	$^{\circ}C$
Input rise and fall time	dt/dv	0~10	ns/V

**Electrical Characteristics**

**DC Characteristics (Ta = -40~85°C)**

Characteristics	Symbol	Test Condition	V <sub>CC</sub> (V)	Min	Typ. (Note 2)	Max	Unit	
Input voltage	"H" level	V <sub>IH</sub>	—	4.5~5.5	2.0	—	—	V
	"L" level	V <sub>IL</sub>	—	4.5~5.5	—	—	0.8	
High-level output voltage	V <sub>OH</sub>	Figure 4	—	—	—	—	—	
Input leakage current	I <sub>IN</sub>	V <sub>IN</sub> = 0~5.5 V	—	4.5~5.5	—	—	±1.0	μA
Power off leakage current	I <sub>OFF</sub>	A, B, OE = 0~5.5 V	—	0	—	—	±1.0	μA
Off-state leakage current (switch off)	I <sub>SZ</sub>	A, B = 0~5.5 V, OE = GND	—	4.5~5.5	—	—	±1.0	μA
ON resistance (Note 3)	R <sub>ON</sub>	V <sub>IS</sub> = 0 V	I <sub>IS</sub> = 30 mA	4.5	—	5	7	Ω
			I <sub>IS</sub> = 64 mA	4.5	—	5	7	
		V <sub>IS</sub> = 2.4 V, I <sub>IS</sub> = 15 mA	4.5	—	35	50		
Quiescent supply current	I <sub>CC</sub>	V <sub>IN</sub> = V <sub>CC</sub> or GND, I <sub>OUT</sub> = 0	Switch ON	5.5	—	—	1.5	mA
			Switch OFF	5.5	—	—	10	μA
	ΔI <sub>CC</sub>	V <sub>IN</sub> = 3.4 V (one input)	(Note 4)	5.5	—	—	2.5	mA

Note 2: Typical values are at V<sub>CC</sub> = 5 V and Ta = 25°C.

Note 3: Measured by the voltage drop between A and B pins at the indicated current through the switch. On resistance is determined by the lower of the voltages on the two (A or B) pins.

Note 4: Quiescent supply current at V<sub>CC</sub> = 3.4 V will be sum of I<sub>CC</sub> and ΔI<sub>CC</sub>.

**AC Characteristics (Ta = -40~85°C)**

Characteristics	Symbol	Test Condition	V <sub>CC</sub> (V)	Min	Max	Unit
Propagation delay time (bus to bus)	t <sub>pLH</sub> t <sub>pHL</sub>	Figure 1, Figure 2 (Note 5)	4.5	—	0.25	ns
Output enable time	t <sub>pZL</sub> t <sub>pZH</sub>	Figure 1, Figure 3	4.5	—	4.5	ns
Output disable time	t <sub>pLZ</sub> t <sub>pHZ</sub>	Figure 1, Figure 3	4.5	—	5.0	ns

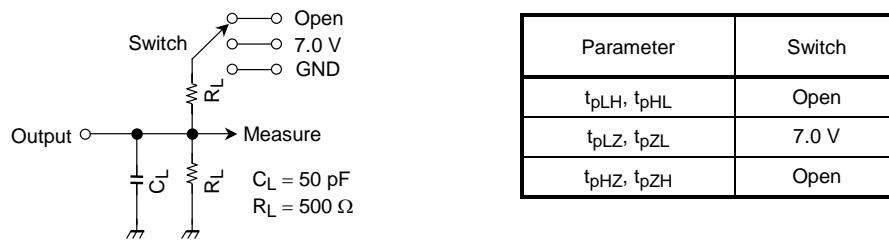
Note 5: This parameter is guaranteed by design but is not tested. The bus switch contributes no propagation delay other than the RC delay of the typical on resistance of the switch and the 50 pF load capacitance, when driven by an ideal voltage the source (zero output impedance).

**Capacitive Characteristics (Ta = 25°C)**

Characteristics	Symbol	Test Condition	V <sub>CC</sub> (V)	Typ.	Unit
Control pin input capacitance	C <sub>IN</sub>	(Note 6)	5.0	3	pF
Switch terminal capacitance	C <sub>I/O</sub>	OE = GND (Note 6)	5.0	10	pF

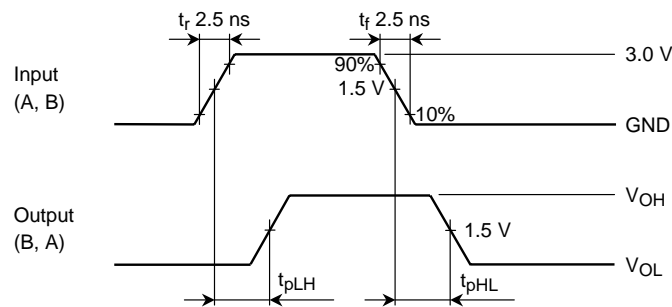
Note 6: This item is guaranteed by design.

**AC Test Circuit**

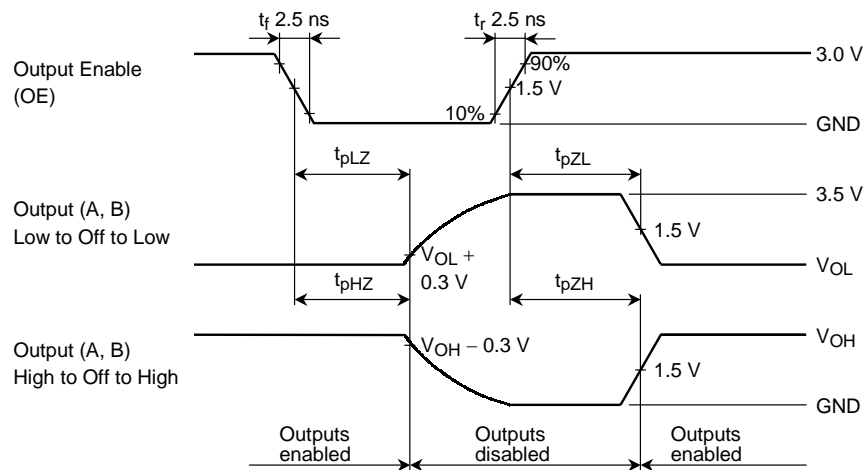


**Figure 1**

**AC Waveform**

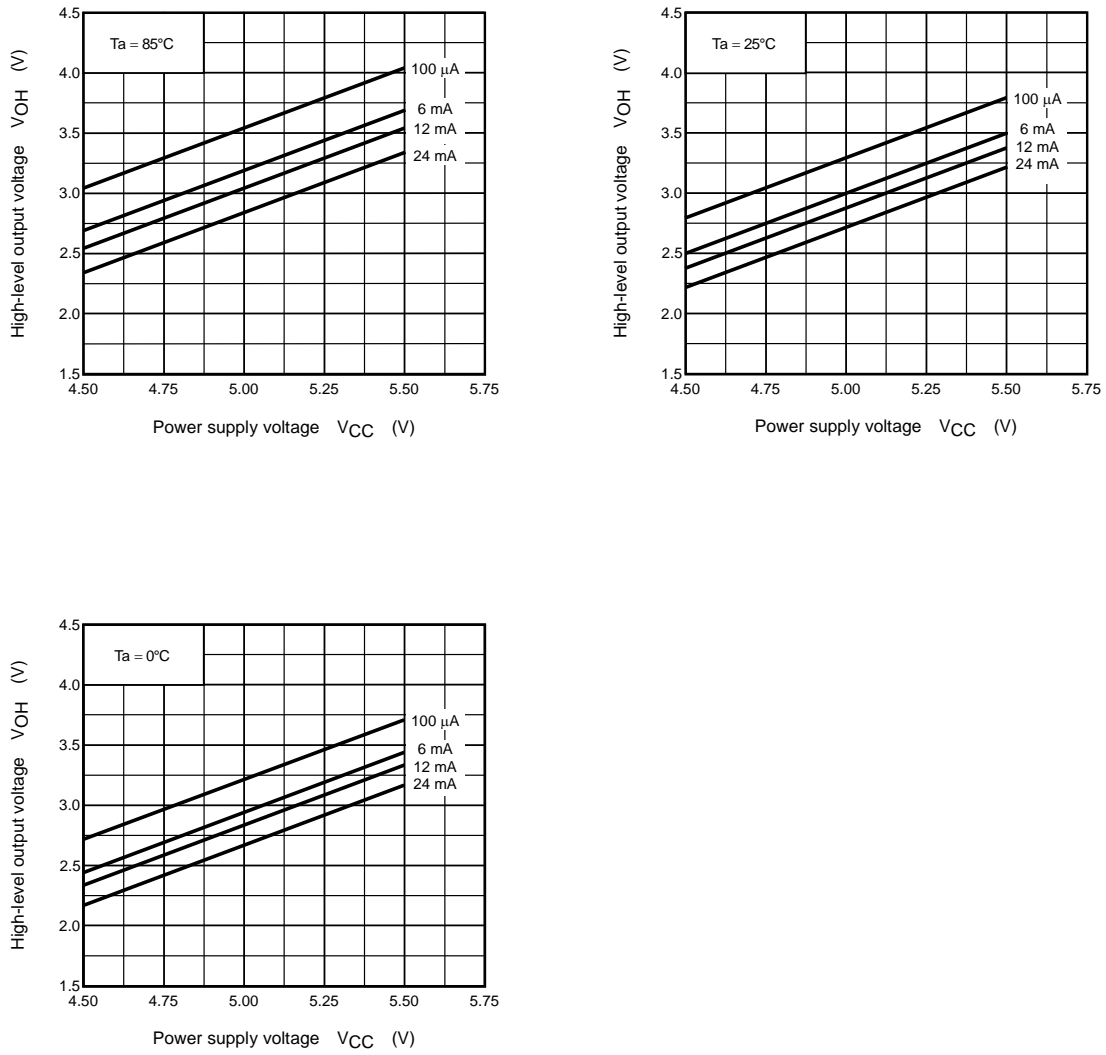


**Figure 2  $t_{pLH}$ ,  $t_{pHL}$**



**Figure 3  $t_{pLZ}$ ,  $t_{pHZ}$ ,  $t_{pZL}$ ,  $t_{pZH}$**

**$V_{OH} - V_{CC}$  Characteristics (typ.)**

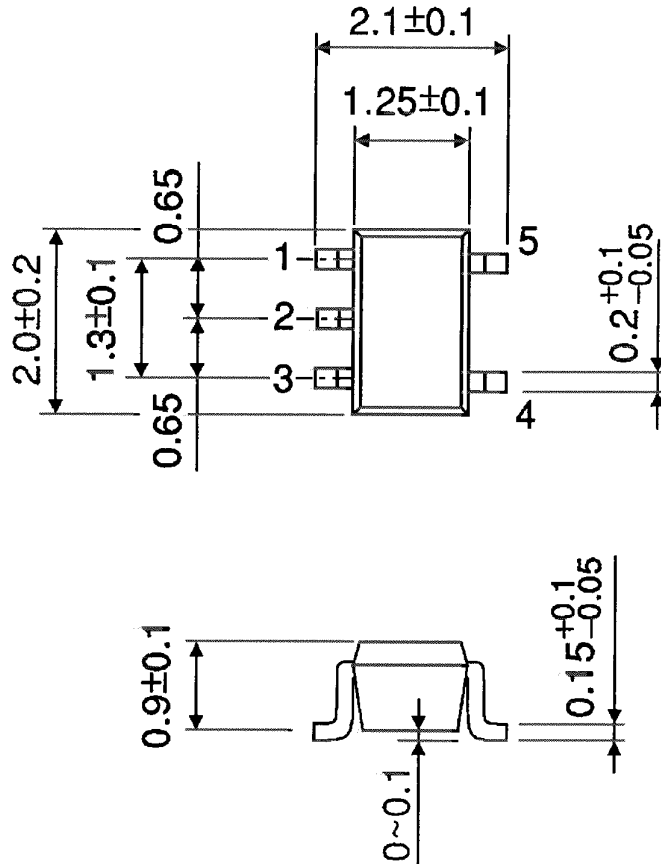


**Figure 4**

## Package Dimensions

SSOP5-P-0.65A

Unit : mm



Weight: 0.006 g (typ.)

**RESTRICTIONS ON PRODUCT USE**

000707EBA

- TOSHIBA is continually working to improve the quality and reliability of its products. Nevertheless, semiconductor devices in general can malfunction or fail due to their inherent electrical sensitivity and vulnerability to physical stress. It is the responsibility of the buyer, when utilizing TOSHIBA products, to comply with the standards of safety in making a safe design for the entire system, and to avoid situations in which a malfunction or failure of such TOSHIBA products could cause loss of human life, bodily injury or damage to property.  
In developing your designs, please ensure that TOSHIBA products are used within specified operating ranges as set forth in the most recent TOSHIBA products specifications. Also, please keep in mind the precautions and conditions set forth in the "Handling Guide for Semiconductor Devices," or "TOSHIBA Semiconductor Reliability Handbook" etc..
- The TOSHIBA products listed in this document are intended for usage in general electronics applications (computer, personal equipment, office equipment, measuring equipment, industrial robotics, domestic appliances, etc.). These TOSHIBA products are neither intended nor warranted for usage in equipment that requires extraordinarily high quality and/or reliability or a malfunction or failure of which may cause loss of human life or bodily injury ("Unintended Usage"). Unintended Usage include atomic energy control instruments, airplane or spaceship instruments, transportation instruments, traffic signal instruments, combustion control instruments, medical instruments, all types of safety devices, etc.. Unintended Usage of TOSHIBA products listed in this document shall be made at the customer's own risk.
- The products described in this document are subject to the foreign exchange and foreign trade laws.
- The information contained herein is presented only as a guide for the applications of our products. No responsibility is assumed by TOSHIBA CORPORATION for any infringements of intellectual property or other rights of the third parties which may result from its use. No license is granted by implication or otherwise under any intellectual property or other rights of TOSHIBA CORPORATION or others.
- The information contained herein is subject to change without notice.