

TOSHIBA CMOS Digital Integrated Circuit Silicon Monolithic

# TC7SZ125F, TC7SZ125FU

Bus Buffer 3-State Output

## Features

- High output drive:  $\pm 24$  mA (min) @  $V_{CC} = 3$  V
- Super high speed operation:  
 $t_{pd}$  2.6 ns (typ.) @  $V_{CC} = 5$  V, 50 pF
- Operation voltage range:  $V_{CC(opr)} = 1.8\sim 5.5$  V
- Power down protection is provided on all inputs and outputs.
- Matches the performance of TC74LCX series when operated at 3.3 V  $V_{CC}$ .

## Marking

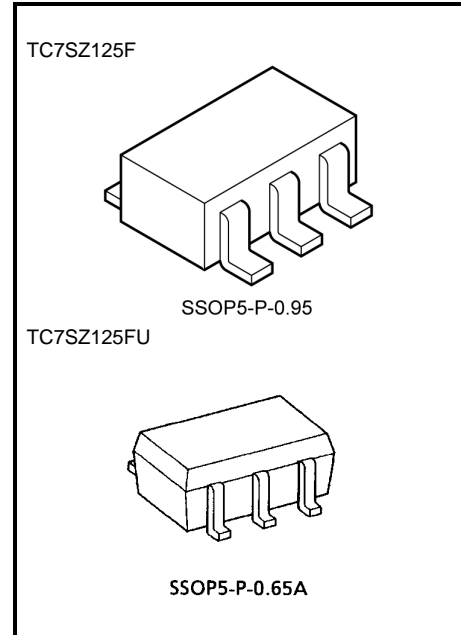
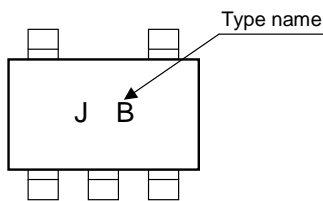

Weight  
 SSOP5-P-0.95 : 0.016 g (typ.)  
 SSOP5-P-0.65A : 0.006 g (typ.)

## Maximum Ratings (Ta = 25°C)

Characteristics	Symbol	Rating	Unit
Power supply voltage	$V_{CC}$	-0.5~6	V
DC input voltage	$V_{IN}$	-0.5~6	V
DC output voltage	$V_{OUT}$	-0.5~6	V
Input diode current	$I_{IK}$	$\pm 20$	mA
Output diode current	$I_{OK}$	$\pm 20$	mA
DC output current	$I_{OUT}$	$\pm 50$	mA
DC $V_{CC}$ /ground current	$I_{CC}$	$\pm 50$	mA
Power dissipation	$P_D$	200	mW
Storage temperature	$T_{stg}$	-65~150	°C
Lead temperature (10s)	$T_L$	260	°C

## Pin Assignment (top view)

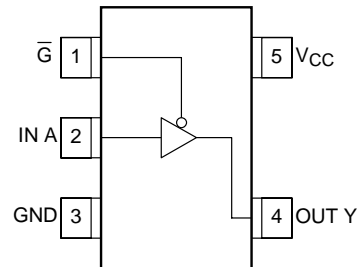

## Logic Diagram

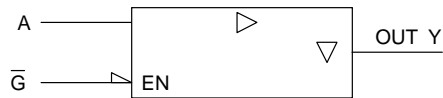

## Truth Table

Input		Output
A	$\bar{G}$	Y
X	H	Z
L	L	L
H	L	H

X: Don't Care  
Z: High Impedance

## Recommended Operating Conditions

Characteristics	Symbol	Rating	Unit
Supply voltage	$V_{CC}$	1.8~5.5	V
		1.5~5.5 (Note 1)	
Input voltage	$V_{IN}$	0~5.5	V
Output voltage	$V_{OUT}$	0~5.5 (Note 2)	V
		0~ $V_{CC}$ (Note 3)	
Operating temperature	$T_{opr}$	-40~85	°C
Input rise and fall time	dt/dv	0~20 ( $V_{CC} = 1.8\text{ V}, 2.5\text{ V} \pm 0.2\text{ V}$ )	ns/V
		0~10 ( $V_{CC} = 3.3\text{ V} \pm 0.3\text{ V}$ )	
		0~5 ( $V_{CC} = 5.5\text{ V} \pm 0.5\text{ V}$ )	

Note 1: Data retention only

Note 2:  $V_{CC} = 0\text{ V}$

Note 3: H and Low state

**Electrical Characteristics**

**DC Characteristics**

Characteristics		Symbol	Test Condition	Ta = 25°C			Ta = -40~85°C		Unit		
				V <sub>CC</sub> (V)	Min	Typ.	Max	Min		Max	
Input voltage	High level	V <sub>IH</sub>	—	1.8	0.88 × V <sub>CC</sub>	—	—	0.88 × V <sub>CC</sub>	—	V	
				2.3~5.5	0.75 × V <sub>CC</sub>	—	—	0.75 × V <sub>CC</sub>	—		
	Low level	V <sub>IL</sub>	—	1.8	—	—	0.12 × V <sub>CC</sub>	—	0.12 × V <sub>CC</sub>		
				2.3~5.5	—	—	0.25 × V <sub>CC</sub>	—	0.25 × V <sub>CC</sub>		
Output voltage	High level	V <sub>OH</sub>	V <sub>IN</sub> = V <sub>IH</sub>	I <sub>OH</sub> = -100 μA	1.8	1.7	1.8	—	1.7	—	V
					2.3	2.2	2.3	—	2.2	—	
					3.0	2.9	3.0	—	2.9	—	
					4.5	4.4	4.5	—	4.4	—	
				I <sub>OH</sub> = -8 mA	2.3	1.9	2.15	—	1.9	—	
				I <sub>OH</sub> = -16 mA	3.0	2.4	2.8	—	2.4	—	
				I <sub>OH</sub> = -24 mA	3.0	2.3	2.68	—	2.3	—	
				I <sub>OH</sub> = -32 mA	4.5	3.8	4.2	—	3.8	—	
	Low level	V <sub>OL</sub>	V <sub>IN</sub> = V <sub>IL</sub>	I <sub>OL</sub> = 100 μA	1.8	—	0	0.1	—	0.1	
					2.3	—	0	0.1	—	0.1	
					3.0	—	0	0.1	—	0.1	
					4.5	—	0	0.1	—	0.1	
				I <sub>OL</sub> = 8 mA	2.3	—	0.1	0.3	—	0.3	
				I <sub>OL</sub> = 16 mA	3.0	—	0.15	0.4	—	0.4	
I <sub>OL</sub> = 24 mA				3.0	—	0.22	0.55	—	0.55		
I <sub>OL</sub> = 32 mA				4.5	—	0.22	0.55	—	0.55		
Input leakage current		I <sub>IN</sub>	V <sub>IN</sub> = 5.5 V or GND	0~5.5	—	—	±1	—	±10	μA	
3-state output off-state current		I <sub>OZ</sub>	V <sub>IN</sub> = V <sub>IH</sub> or V <sub>IL</sub> V <sub>OUT</sub> = 0~5.5 V	1.8~5.5	—	—	±1	—	±10	μA	
Power off leakage current		I <sub>OFF</sub>	V <sub>IN</sub> or V <sub>OUT</sub> = 5.5 V	0.0	—	—	1	—	10	μA	
Quiescent supply current		I <sub>CC</sub>	V <sub>IN</sub> = V <sub>CC</sub> or GND	5.5	—	—	2	—	20	μA	

**AC Characteristics (unless otherwise specified, Input:  $t_r = t_f = 3$  ns)**

Characteristics	Symbol	Test Condition	Ta = 25°C				Ta = -40~85°C		Unit
			VCC (V)	Min	Typ.	Max	Min	Max	
Propagation delay time	$t_{pLH}$	$C_L = 15$ pF, $R_L = 1$ M $\Omega$	1.8	2.0	5.3	11.0	2.0	11.5	ns
			$2.5 \pm 0.2$	0.8	3.4	7.5	0.8	8.0	
	$3.3 \pm 0.3$		0.5	2.5	5.2	0.5	5.5		
	$5.0 \pm 0.5$		0.5	2.1	4.5	0.5	4.8		
	$t_{pHL}$		$3.3 \pm 0.3$	1.5	3.2	5.7	1.5	6.0	
			$5.0 \pm 0.5$	0.8	2.6	5.0	0.8	5.3	
Output enable time	$t_{pZL}$	$C_L = 50$ pF, $R_L = 500$ $\Omega$	1.8	2.0	7.0	12.5	2.0	13.0	ns
			$2.5 \pm 0.2$	1.5	4.6	8.5	1.5	9.0	
	$3.3 \pm 0.3$		1.5	3.5	6.2	1.5	6.5		
	$5.0 \pm 0.5$		0.8	2.8	5.5	0.8	5.8		
Output disable time	$t_{pLZ}$	$C_L = 50$ pF, $R_L = 500$ $\Omega$	1.8	2.0	5.4	11.0	2.0	12.0	ns
			$2.5 \pm 0.2$	1.5	3.5	8.0	1.5	8.5	
	$3.3 \pm 0.3$		1.0	2.8	5.7	1.0	6.0		
	$5.0 \pm 0.5$		0.5	2.1	4.7	0.5	5.0		
Input capacitance	$C_{IN}$	—	0~5.5	—	4	—	—	pF	
Power dissipation capacitance	$C_{PD}$	(Note 4)	3.3	—	17	—	—	—	pF
			5.5	—	24	—	—	—	

Note 4:  $C_{PD}$  is defined as the value of the internal equivalent capacitance which is calculated from the operating current consumption without load.

Average operating current can be obtained by the equation:

$$I_{CC (opr)} = C_{PD} \cdot V_{CC} \cdot f_{IN} + I_{CC}$$

**AC Characteristics Measurement Circuit**

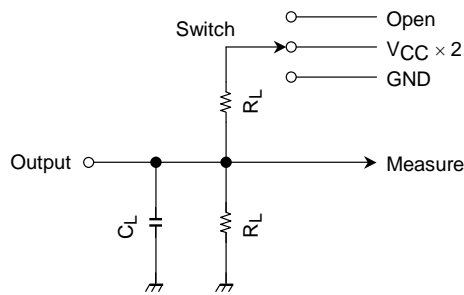

Characteristics	Switch
$t_{pLH}, t_{pHL}$	Open
$t_{pLZ}, t_{pZL}$	$V_{CC} \times 2$
$t_{pHZ}, t_{pZH}$	GND

## Package Dimensions

SSOP5-P-0.95

Unit : mm

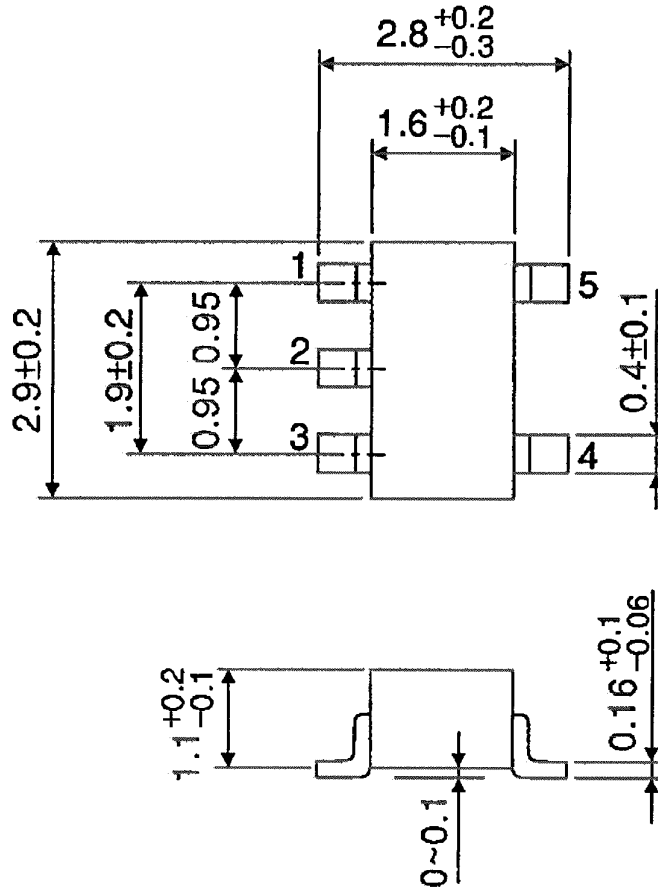

Weight: 0.016 g (typ.)

## Package Dimensions

SSOP5-P-0.65A

Unit : mm

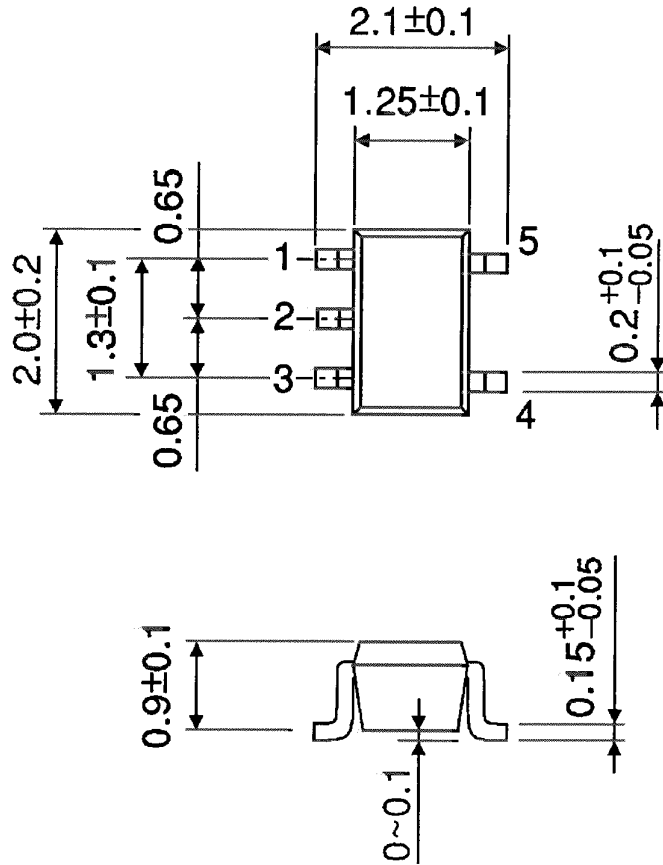

Weight: 0.006 g (typ.)

**RESTRICTIONS ON PRODUCT USE**

000707EBA

- TOSHIBA is continually working to improve the quality and reliability of its products. Nevertheless, semiconductor devices in general can malfunction or fail due to their inherent electrical sensitivity and vulnerability to physical stress. It is the responsibility of the buyer, when utilizing TOSHIBA products, to comply with the standards of safety in making a safe design for the entire system, and to avoid situations in which a malfunction or failure of such TOSHIBA products could cause loss of human life, bodily injury or damage to property.  
In developing your designs, please ensure that TOSHIBA products are used within specified operating ranges as set forth in the most recent TOSHIBA products specifications. Also, please keep in mind the precautions and conditions set forth in the "Handling Guide for Semiconductor Devices," or "TOSHIBA Semiconductor Reliability Handbook" etc..
- The TOSHIBA products listed in this document are intended for usage in general electronics applications (computer, personal equipment, office equipment, measuring equipment, industrial robotics, domestic appliances, etc.). These TOSHIBA products are neither intended nor warranted for usage in equipment that requires extraordinarily high quality and/or reliability or a malfunction or failure of which may cause loss of human life or bodily injury ("Unintended Usage"). Unintended Usage include atomic energy control instruments, airplane or spaceship instruments, transportation instruments, traffic signal instruments, combustion control instruments, medical instruments, all types of safety devices, etc.. Unintended Usage of TOSHIBA products listed in this document shall be made at the customer's own risk.
- The products described in this document are subject to the foreign exchange and foreign trade laws.
- The information contained herein is presented only as a guide for the applications of our products. No responsibility is assumed by TOSHIBA CORPORATION for any infringements of intellectual property or other rights of the third parties which may result from its use. No license is granted by implication or otherwise under any intellectual property or other rights of TOSHIBA CORPORATION or others.
- The information contained herein is subject to change without notice.