

## LM4682 Boomer® Audio Power Amplifier Series

# 10 Watt Stereo CLASS D Audio Power Amplifier with Stereo Headphone Amplifier and DC Volume Control

### General Description

The LM4682 is a fully integrated single supply, high efficiency audio power amplifier solution. The LM4682 utilizes a proprietary balanced pulse-width modulation technique that lowers output noise and THD and improves PSRR when compared to conventional pulse width modulators.

The LM4682 also features a stereo headphone amplifier that delivers 60mW into a 32Ω headset with less than 0.5% THD.

The LM4682's DC volume control has a +30dB to -48dB range when speakers are driven and a range of +13dB to -65dB when headphones are connected. All amplifiers are protected by thermal shutdown. Additionally, all amplifiers incorporate output current limiting function to protect their outputs from short circuit.

The LM4682 features a low-power consumption shutdown mode. And its efficiency reaches 85% for a 10W output power with an 8Ω load. External heatsink is not required when playing music. The IC features click and pop reduction circuitry that minimizes audible popping during device turn-on and turn-off. The LM4682 is available in a 48-lead LLP package, ideal for portable and desktop computer applications.

### Key Specifications

■ $P_O$ at THD+N = 10%, $V_{DD} = 14V$	10W (typ)
■ THD+N at 1kHz at 6W into 8Ω (Power Amp)	0.2% (typ)
■ Efficiency at 7W into 8Ω	84% (typ)
■ Total quiescent power supply current	52mA (typ)
■ Total shutdown power supply current	0.1mA (typ)
■ THD+N 1kHz, 20mW, 32Ω (Headphone)	0.02% (typ)
■ Single supply range	8.5V to 15V

### Features

- Pulse-width modulator.
- DC Volume Control
- Stereo headphone amplifier.
- "Click and pop" suppression circuitry.
- Micropower shutdown mode.
- 48 lead LLP package (No heatsink required).

### Applications

- Flat Panel Displays
- Televisions
- Multimedia Monitors

# Block Diagram

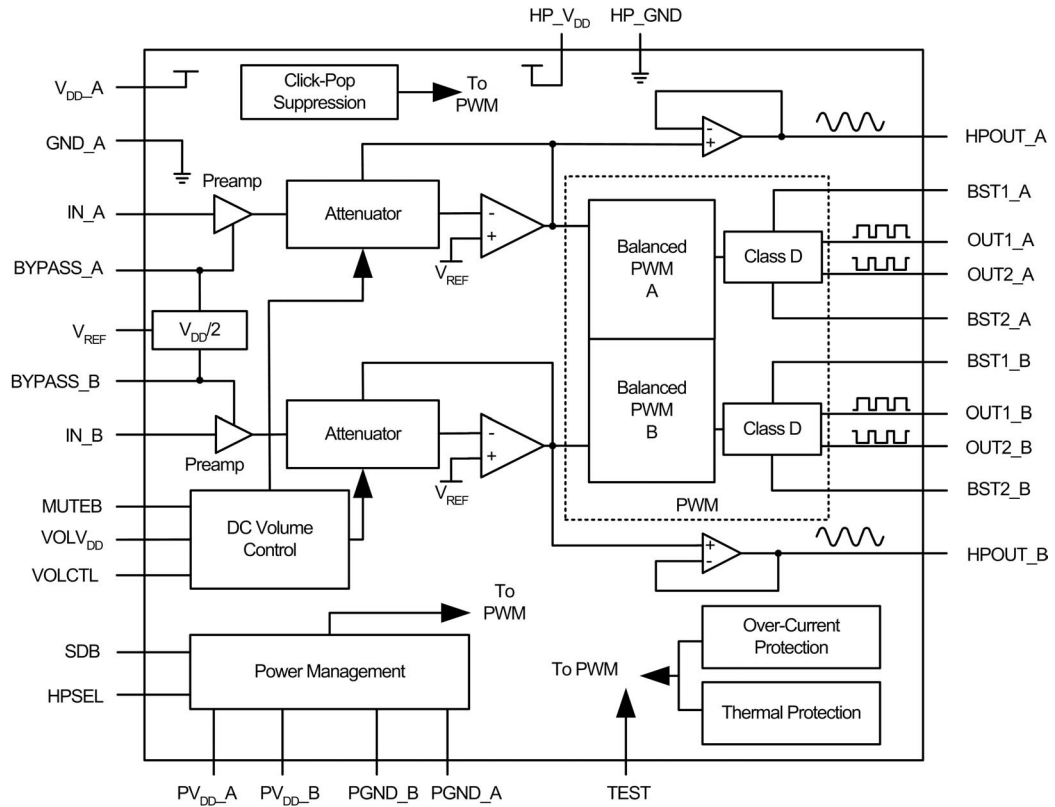

Block Diagram for LM4682

20119622

# Connection Diagram

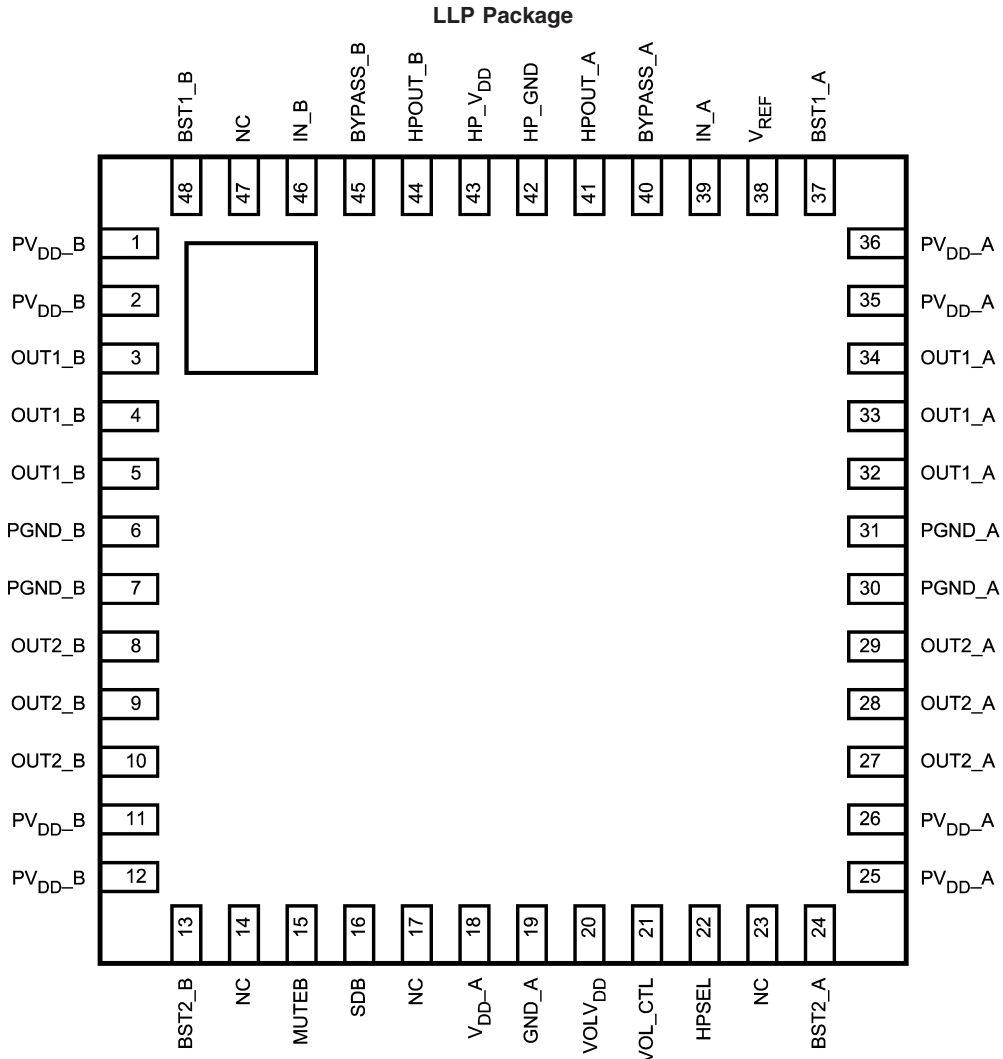

**Top View**  
**Order Number LM4682SQ**  
**See NS Package Number SQA48A**  
**(LLP Package)**

20119618

# Typical Application

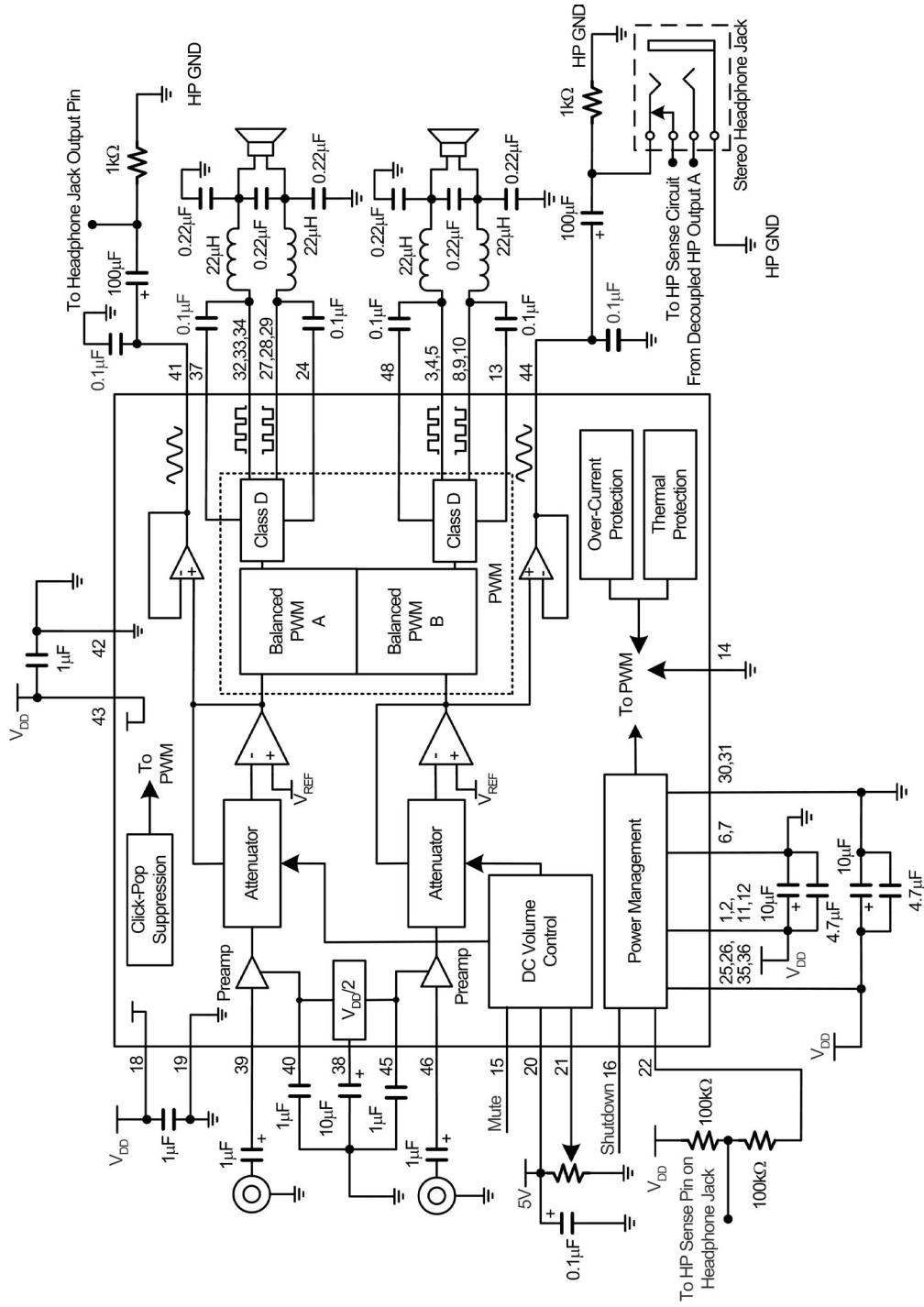

20119621

Figure 1: Typical Stereo Audio Amplifier with Headphone Selection Circuit

**Absolute Maximum Ratings** (Note 2)

If Military/Aerospace specified devices are required, please contact the National Semiconductor Sales Office/Distributors for availability and specifications.

Supply Voltage	15.5V
Input Voltage	-0.3V to $V_{DD} + 0.3V$
Power Dissipation (Note 3)	Internally Limited
ESD Susceptibility (Note 4)	2000V
ESD Susceptibility (Note 5)	200V
Junction Temperature (Note 6)	150°C
Storage Temperature	$-65^{\circ}\text{C} \leq T_A \leq 150^{\circ}\text{C}$

## Soldering Information

**LLP Package**

Vapor Phase (60 sec.)	215°C
Infrared (15 sec.)	220°C

See AN-450 "Surface Mounting and their Effects on Product Reliability" for other methods of soldering surface mount devices.

**Operating Ratings** (Notes 1, 2)

Temperature Range	$T_{MIN} \leq T_A \leq T_{MAX}$	$-40^{\circ}\text{C} \leq T_A \leq +85^{\circ}\text{C}$
Supply Voltage		$8.5V \leq V_{DD} \leq 15V$
Thermal Resistance (LLP Package)		
$\theta_{JA}$		28°C/W
$\theta_{JC}$		20°C/W

**Electrical Characteristics** (Notes 1, 2, 7)

The following specifications apply for  $V_{DD} = 12V$ ,  $VOLV_{DD} = 5V$ ,  $R_L = 8\Omega$ , LC filter values as shown in Figure 1, unless otherwise specified. Limits apply for  $T_A = 25^{\circ}\text{C}$ .

Symbol	Parameter	Conditions	LM4682			Units
			Typical	Max	Min	
$V_{DD}$	Operating Supply Voltage Range		12	15	8.5	V
$I_S$	Quiescent Power Supply Current, Class D Mode	$V_{IN} = 0V_{RMS}$ , $V_{HPSEL} = 0V$	52	70		mA
	Quiescent Power Supply Current, Headphone Mode	$V_{IN} = 0V_{RMS}$ , $V_{HPSEL} = 12V$	30	40		mA
$I_{SD}$	Quiescent Power Supply Current, Shutdown Mode	SDB = 0V	0.1			mA
$R_{IN}$	Input Resistance in Both Modes		8			k $\Omega$
$VOLV_{DD}$	DC Reference Supply Voltage			5.5	3	V
$V_{IH}$	Minimum Logic High Input Voltage	SDB, MUTE B pins			$0.7 \times VOLV_{DD}$	V
$V_{IL}$	Maximum Logic Low Input Voltage			$0.3 \times VOLV_{DD}$		V
$V_{HPIH}$	HP Sense High Input Voltage				$V_{DD} - 1$	V
$V_{HPIL}$	HP Sense Low Input Voltage			$V_{DD}/2$		V
<b>Power Amplifiers</b>						
$P_{OR}$	Output Power, Per Channel	THD+N $\leq 1\%$ , $f_{IN} = 1\text{kHz}$	6.0		5.5	W
$P_{D1}$	Power Dissipation	$P_O = 7W/\text{Chan}$ , $f_{IN} = 1\text{kHz}$	2.6			W
$E_{FF1}$	Efficiency	$P_O = 7W/\text{Chan}$ , $f_{IN} = 1\text{kHz}$	84.4			%
THD+N	Harmonic Distortion + Noise	$P_O = 6W/\text{Chan}$ , $f_{IN} = 1\text{kHz}$	0.2			%
$V_{NOISE}$	Output Noise Voltage, RMS. A-Weighted	$R_{SOURCE} = 50\Omega$ , $C_{IN} = 1\mu\text{F}$ , BW = 8Hz to 22kHz A-weighted, input referred	13			$\mu\text{V}$
PSRR	Power Supply Rejection Ratio	$V_{RIPPLE} = 200\text{mVpp}$ , 1kHz, $V_{IN} = 0$ , input referred				dB
		f = 50Hz	94			
		f = 60Hz	94			
		f = 100Hz	93			
		f = 120Hz	93			
		f = 1kHz	84			
<b>Headphone Amplifiers</b>						

**Electrical Characteristics** (Notes 1, 2, 7) (Continued)

The following specifications apply for  $V_{DD} = 12V$ ,  $V_{OLV_{DD}} = 5V$ ,  $R_L = 8\Omega$ , LC filter values as shown in Figure 1, unless otherwise specified. Limits apply for  $T_A = 25^\circ C$ .

Symbol	Parameter	Conditions	LM4682			Units
			Typical	Max	Min	
$P_O$	Power Out Per Channel	THD+N $\leq$ 1%, $R_L = 32\Omega$ , $f_{IN} = 1kHz$	80		60	mW
THD+N	Distortion + Noise	$P_O = 20mW$ , $R_L = 32\Omega$ , $f_{IN} = 1kHz$	0.02			%
$V_{NOISE}$	Output Noise Voltage, RMS	$R_{IN} = 50\Omega$ , $C_{IN} = 1\mu F$ , BW = 20Hz to 20kHz A-weighted, input referred	9			$\mu V$
PSRR	Power Supply Rejection Ratio (Referred to Input)	200mV, 1kHz, $V_{IN} = 0$ , $R_L = 32\Omega$	88			dB

**Electrical Characteristics for Volume Control** (Notes 1, 2)

The following specifications apply for  $V_{DD} = 12V$ . Limits apply for  $T_A = 25^\circ C$ .

Symbol	Parameter	Conditions	LM4682		Units (Limits )
			Typical (Note 8)	Limit (Note 7)	
$C_{RANGE}$	Gain Range	VOL_CTL voltage = $V_{OLV_{DD}}$ voltage, No Load			
		Power Amplifier	30	29	dB (min)
		Headphone Amplifier	13	12	dB (min)
		VOL_CTL voltage = $0.069 \times V_{OLV_{DD}}$ No Load			
		Power Amplifier	-48	-46	dB (min)
		Headphone Amplifier	-65	-63	dB (min)
$A_M$	Mute Gain	$V_{MUTE}$ voltage = 0V, No Load			
		Power Amplifier	-80	-60	dB (max)
		Headphone Amplifier	-70	-60	dB (max)

**Note 1:** All voltages are measured with respect to the ground pin, unless otherwise specified.

**Note 2:** "Absolute Maximum Ratings" indicate limits beyond which damage to the device may occur. "Operating Ratings" indicate conditions for which the device is functional, but do not guarantee specific performance limits. "Electrical Characteristics" state DC and AC electrical specifications under particular test conditions which guarantee specific performance limits. This assumes that the device is within the Operating Ratings. Specifications are not guaranteed for parameters where no limit is given, however, the typical value is a good indication of device performance.

**Note 3:** For operating at case temperatures above  $25^\circ C$ , the device must be derated based on a  $150^\circ C$  maximum junction temperature and a thermal resistance of  $\theta_{JA} = 28^\circ C/W$  (junction to ambient).

**Note 4:** Human body model, 100pF discharged through a 1.5k $\Omega$  resistor. Device pin 16 has ESD HBM rating = 1500V.

**Note 5:** Machine Model 220pF–240pF discharged through all pins.

**Note 6:** The operating junction temperature maximum is  $150^\circ C$ .

**Note 7:** Limits are guaranteed to National's AOQL (Average Outgoing Quality Level).

**Note 8:** Typicals are measured at  $25^\circ C$  and represent the parametric norm.

# Typical Performance Characteristics (Power Amplifier)

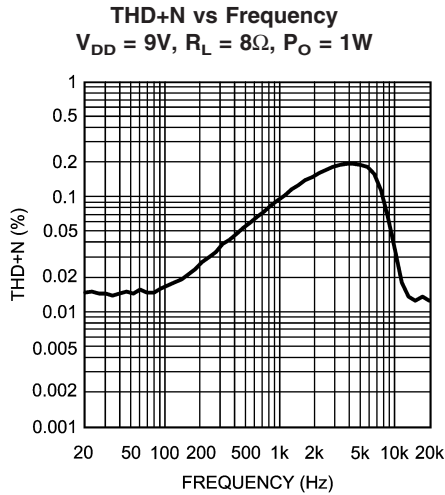

20119658

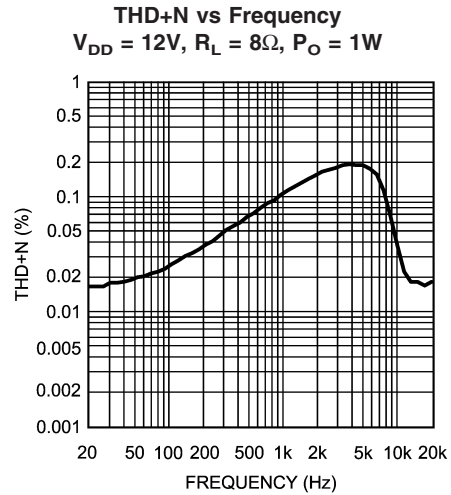

20119659

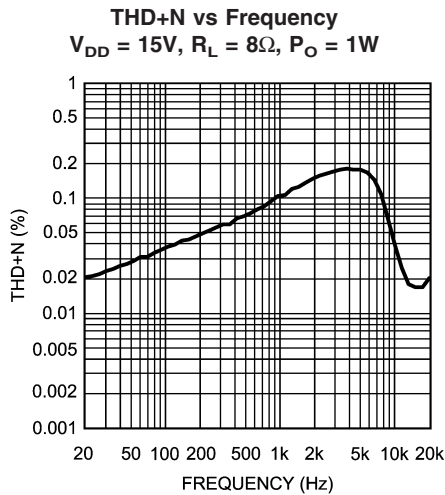

20119660

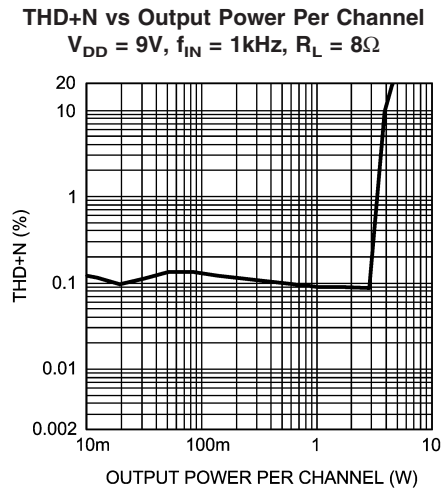

20119661

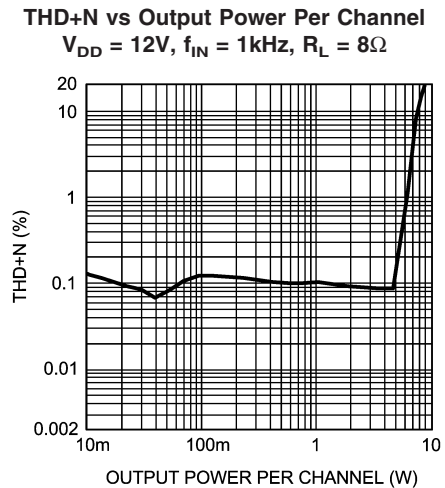

20119662

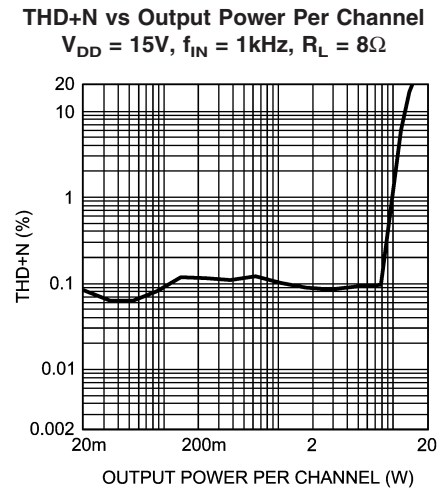

20119663

Typical Performance Characteristics (Power Amplifier) (Continued)

THD+N vs Output Power Per Channel  
 $V_{DD} = 12V, f_{IN} = 10kHz, R_L = 8\Omega$

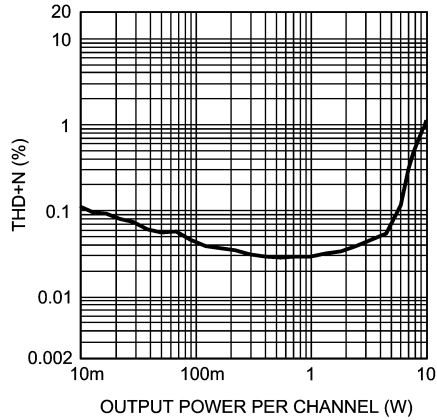

20119664

THD+N vs Output Power Per Channel  
 $V_{DD} = 12V, f_{IN} = 20Hz, R_L = 8\Omega$

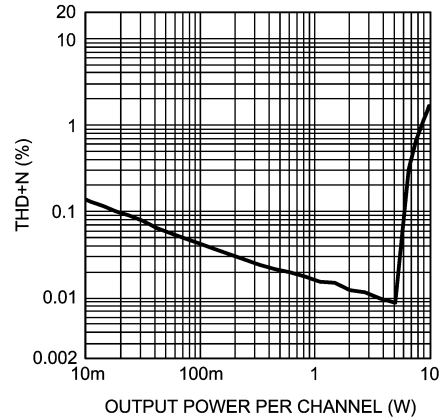

20119665

Output Power vs Supply Voltage  
 $f_{IN} = 1kHz, R_L = 8\Omega$

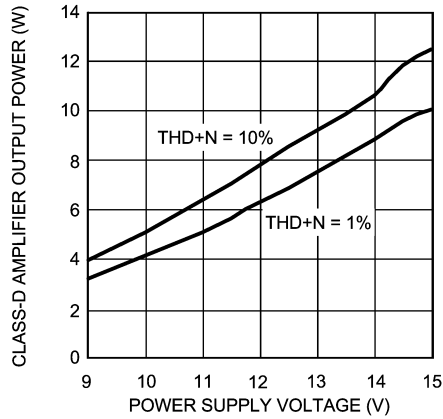

20119667

Amplifiers Gain vs Frequency  
 $V_{DD} = 9V, R_L = 8\Omega, P_O = 1W$

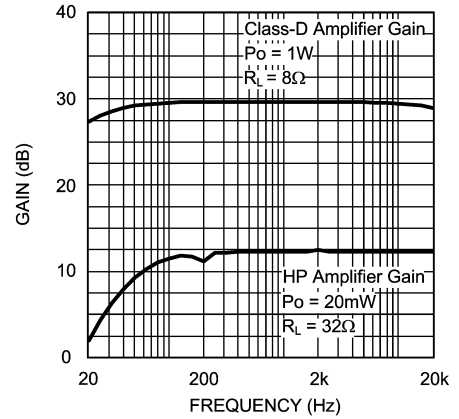

20119647

Amplifiers Gain vs Frequency  
 $V_{DD} = 12V, R_L = 8\Omega, P_O = 1W$

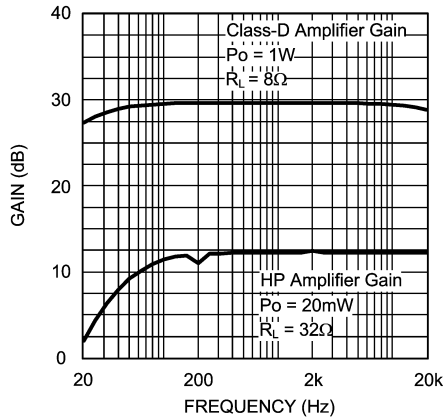

20119648

Amplifiers Gain vs Frequency  
 $V_{DD} = 15V, R_L = 8\Omega, P_O = 1W$

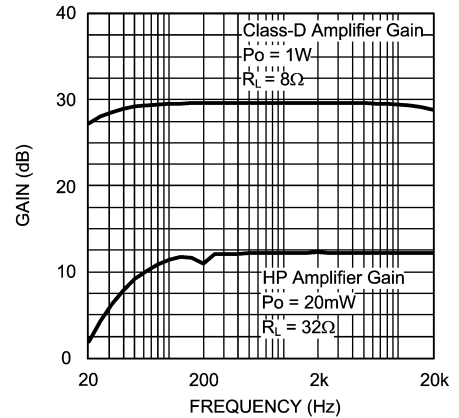

20119649



# Typical Performance Characteristics (Power Amplifier) (Continued)

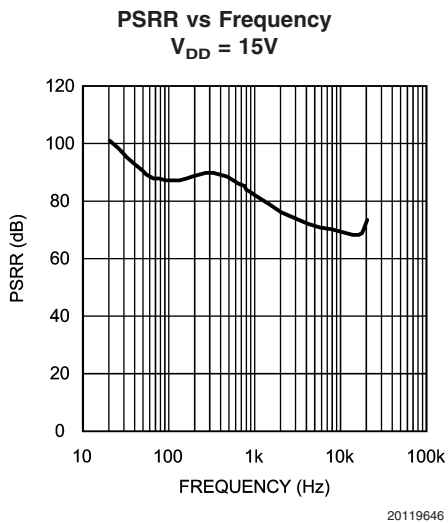
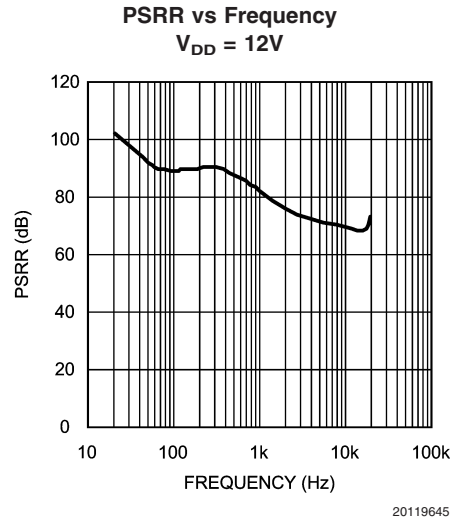
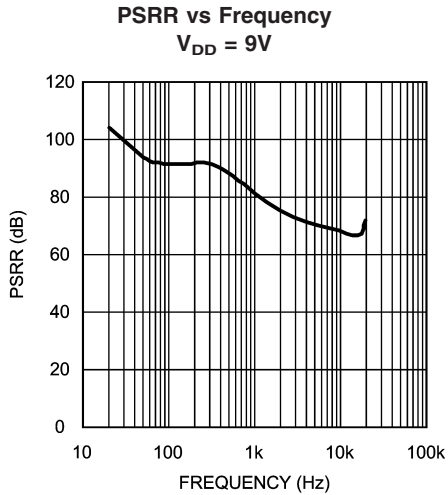

**Class-D Amplifier Dissipation vs Load Dissipation Per Channel,  $V_{DD} = 9V$ ,  $R_L = 8\Omega$  (both channels driven and measured)**

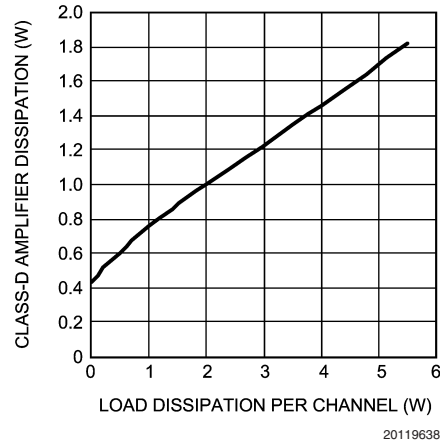

**Class-D Amplifier Dissipation vs Load Dissipation Per Channel,  $V_{DD} = 12V$ ,  $R_L = 8\Omega$  (both channels driven and measured)**

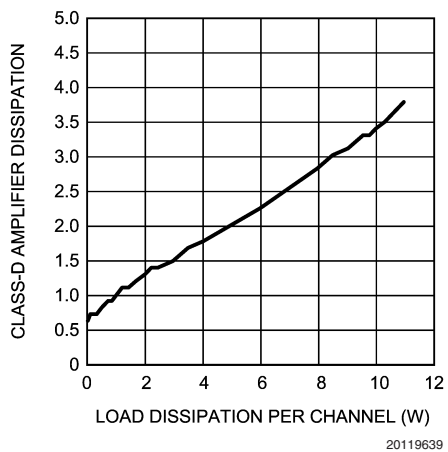

**Class-D Amplifier Dissipation vs Load Dissipation Per Channel,  $V_{DD} = 15V$ ,  $R_L = 8\Omega$  (both channels driven and measured)**

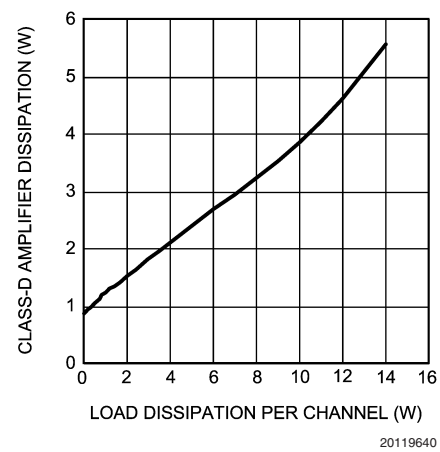

# Typical Performance Characteristics (Power Amplifier) (Continued)

**Efficiency vs Output Power**  
 $V_{DD} = 9V, R_L = 8\Omega$   
 (both channels driven and measured)

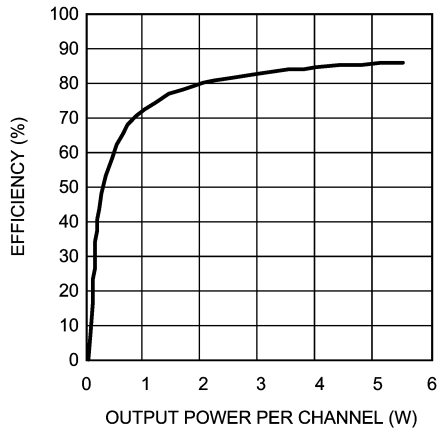

20119641

**Efficiency vs Output Power**  
 $V_{DD} = 12V, R_L = 8\Omega$   
 (both channels driven and measured)

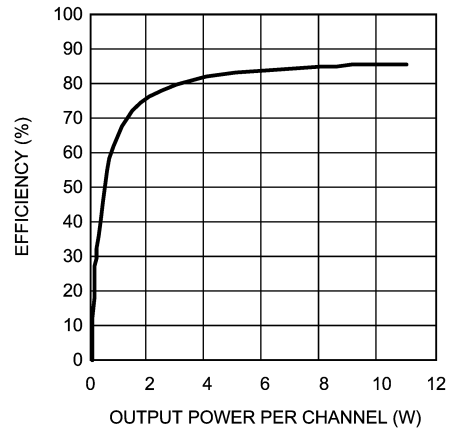

20119642

**Efficiency vs Output Power**  
 $V_{DD} = 15V, R_L = 8\Omega$   
 (both channels driven and measured)

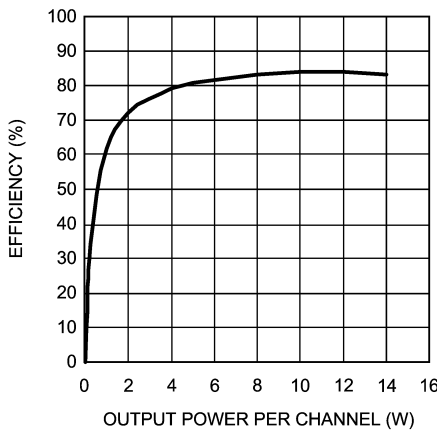

20119643

**Output Power vs Load Resistance**  
 $V_{DD} = 9V, f_{IN} = 1kHz$   
 (both channels driven and measured)

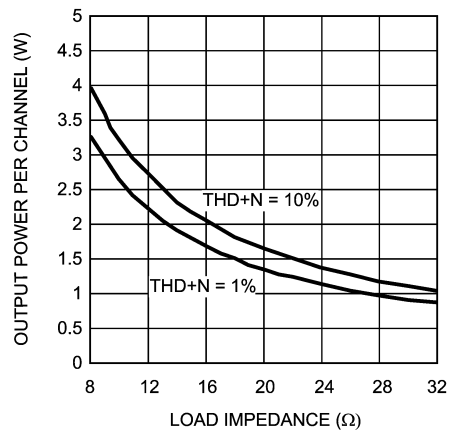

20119655

**Output Power vs Load Resistance**  
 $V_{DD} = 12V, f_{IN} = 1kHz$   
 (both channels driven and measured)

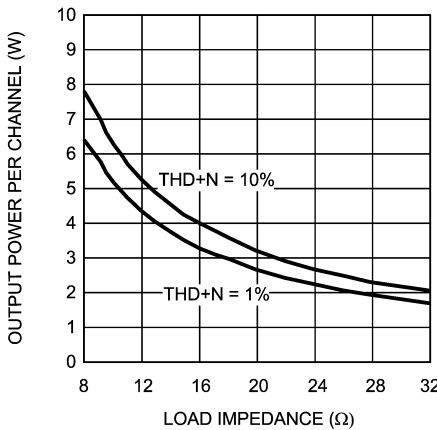

20119656

**Output Power vs Load Resistance**  
 $V_{DD} = 15V, f_{IN} = 1kHz$   
 (both channels driven and measured)

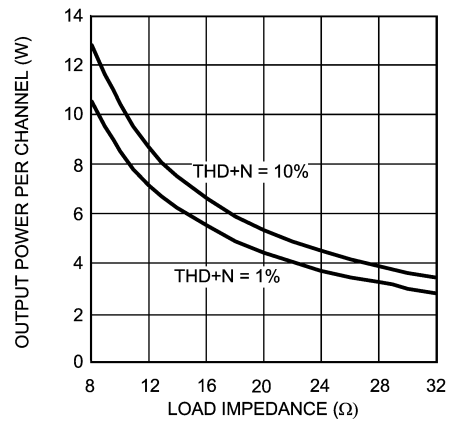

20119657

# Typical Performance Characteristics (Power Amplifier) (Continued)

Power Supply Current vs Power Supply Voltage

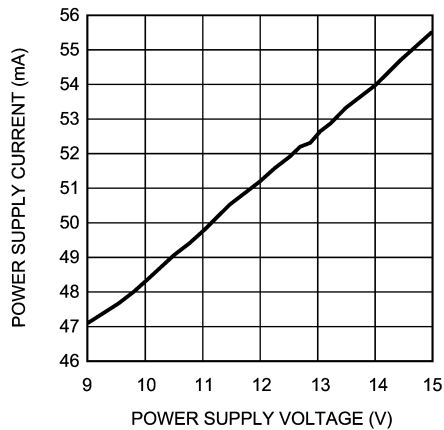

20119654

# Typical Performance Characteristics (Headphone Amplifier)

THD+N vs Frequency

$V_{DD} = 9V, R_L = 32\Omega, P_O = 20mW$

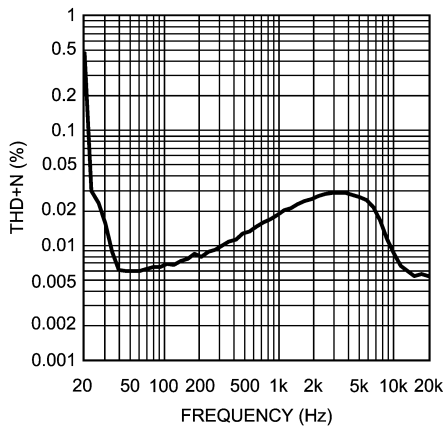

20119651

THD+N vs Frequency

$V_{DD} = 12V, R_L = 32\Omega, P_O = 20mW$

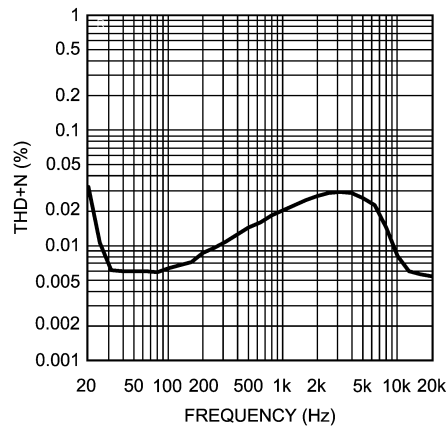

20119652

THD+N vs Frequency

$V_{DD} = 15V, R_L = 32\Omega, P_O = 20mW$

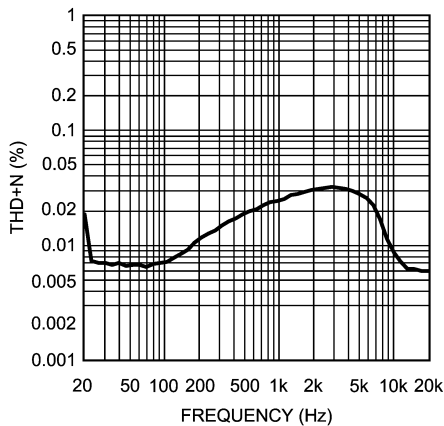

20119653

THD+N vs Output Power

$V_{DD} = 9V, R_L = 32\Omega, f_{IN} = 1kHz$

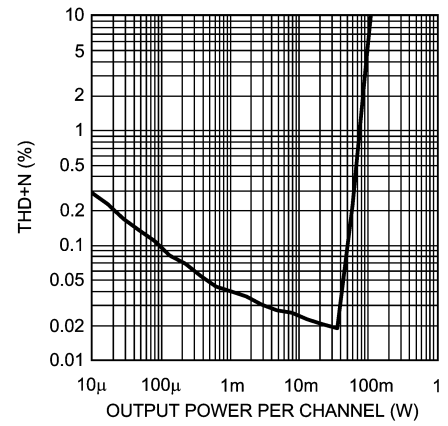

20119668

Typical Performance Characteristics (Headphone Amplifier) (Continued)

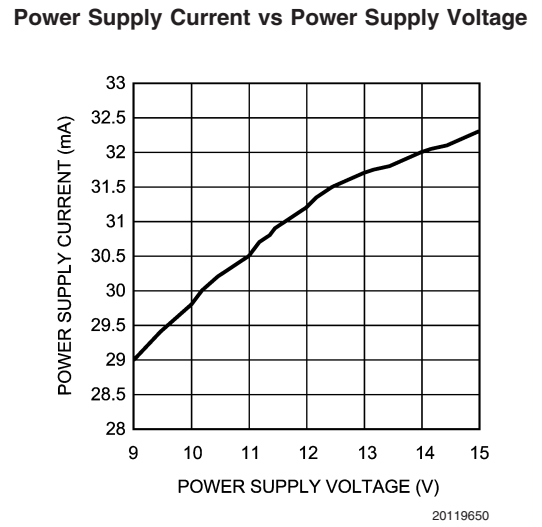
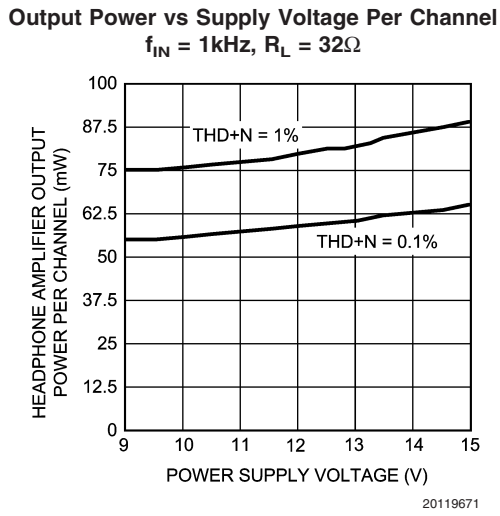
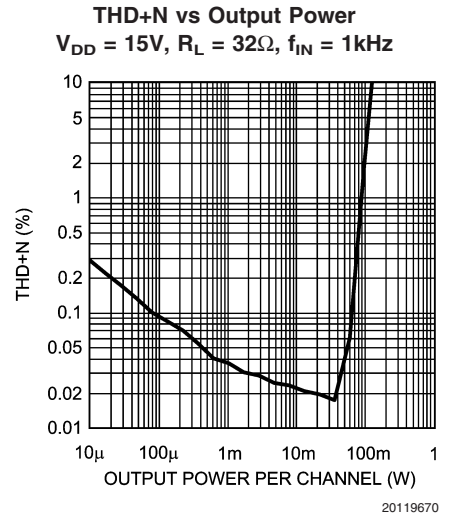
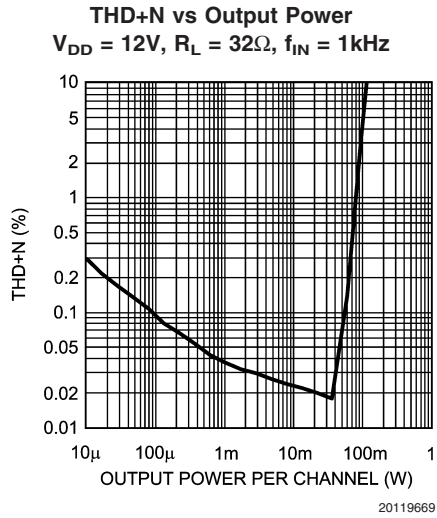

## General Features

### SYSTEM FUNCTIONAL INFORMATION

#### Modulation Technique

Unlike typical Class D amplifiers that use single-ended comparators to generate a pulse-width modulated switching waveform and RC timing circuits to set the switching frequency, the LM4682 uses a balanced differential floating modulator. Oscillation is a result of injecting complimentary currents onto the respective plates of a floating, on-die capacitor. The value of the floating capacitor and value of the components in the modulator's feedback network set the nominal switching frequency at 450kHz. Modulation results from imbalances in the injected currents. The amount of current imbalance is directly proportional to the applied input signal's magnitude and frequency.

Using a balanced, floating modulator produces a Class D amplifier that is immune to common mode noise sources such as substrate noise. This noise occurs because of the high frequency, high current switching in the amplifier's output stage. The LM4682 is immune to this type of noise because the modulator, the components that set its switching frequency, and even the load all float with respect to ground.

The balanced modulator's pulse width modulated output drives the gates of the LM4682's H-bridge configured output power MOSFETs. The pulse-train present at the power MOSFETs' output is applied to an LC low pass filter that removes the 450kHz energy component. The filter's output signal, which is applied to the driven load, is an amplified replica of the audio input signal.

#### Shutdown Function

The LM4682's active-low shutdown function allows the user to place the amplifier in a shutdown mode while the system power supply remains active. Activating shutdown stops the output switching waveform and minimizes the quiescent current. Applying logic "0" to SDB pin enables the shutdown function. Applying logic "1" to SDB pin disables the shutdown function and restores full amplifier operation.

#### Mute Function

The LM4682's active-low mute function allows the user to place the amplifier outputs in muted mode while the amplifier's analog input signals remain active. Activating mute internally removes the analog input signal from the Class D and headphone amplifier inputs. While muted the amplifier inputs and outputs retain in their VDD/2 operational bias. Applying logic "0" to MUTE pin activates mute. Applying logic "1" to MUTE pin deactivates mute. The MUTE pin is pull-down internally to put both Class D and headphone amplifier outputs mute.

#### Stereo Headphone Amplifier

The LM4682's stereo headphone amplifier operates continuously, even while the Class D amplifiers are active. When using headphones to listen to program material, it is usually desirable to stop driving external speakers. This is easily achieved by using the active high HPSEL input. As shown in typical application schematic in Figure 1, with no headphones connected to the headphone jack, the input voltage applied to the HPSEL pin is a logic low. In this state, the Class D amplifiers are active and able to drive external speakers. When headphones are plugged into the headphone jack, the switch inside the jack is opened. This

changes the voltage applied to the HPSEL pin to a logic high, shutting off the LM4682's Class D amplifiers. The headphone control of the output configuration is shown in Table 1.

TABLE 1. Headphone Controls

HP Sense Pin, HPSEL	Output Stage Configuration
0	Class D Amps Active
1	Class D Amps Inactive

#### Under Voltage Protection

The under voltage protection disables the output driver section of the LM4682 while the supply voltage is below 8V. This condition may occur as power is first applied or during low line conditions, changes in load resistance, or when power supply sag occurs. The under voltage protection ensures that all of the LM4682's power MOSFETs are off. This action eliminates shoot-through current and minimizes output transients during turn-on and turn-off. The under voltage protection gives the digital logic time to stabilize into known states, further minimizing turn on output transients.

#### Power Supply Sequencing

In order to stabilize LM4682 before any operation, a power-up sequence for the power supplies is recommended. The Power V<sub>DD</sub> should be applied first. Without deactivating the mute and shutdown function of the amplifiers, the VOLV<sub>DD</sub> is then applied. Prior to removing the two supply voltages, activate shutdown and mute.

#### Turn-On Time

The LM4682 has an internal timer that determines the amplifier's turn-on time. After power is first applied or the part returns from shutdown, the nominal turn-on time is 600ms. This delay allows all externally applied capacitors to charge to a final value of V<sub>DD</sub>/2. Further, during turn-on, the outputs are muted. This minimizes output transients that may occur while the part settles into its quiescent operating mode.

#### Output Stage Current Limit and Fault Detection Protection

The output stage MOSFETs are protected against output conditions that could otherwise compromise their operational status. The first stage of protection is output current limiting. When conditions that require high currents to drive a load, the LM4682's current limit circuitry clamps the output current at a nominal value of 2.5A. The output waveform is present, but may be clipped or its amplitude reduced. The same 2.5A nominal current limit also occurs if the amplifier outputs are shorted together or either output is shorted to V<sub>DD</sub> or GND.

The second stage of protection is an onboard fault detection circuit that continuously monitors the signal on each output MOSFET's gate and compares it against the respective drain voltage. When a condition is detected that violates a MOSFET's Safe Operating Area (SOA) and the drive signal is disconnected from the output MOSFETs' gates. The fault detect circuit maintains this protective condition for approximately 600ms, at which time the drive signal is reconnected. If the fault condition is no longer present, normal operation resumes. If the fault condition remains, however, the drive signal is again disconnected.

## General Features (Continued)

### Thermal Protection

The LM4682 has thermal shutdown circuitry that monitors the die temperature. Once the LM4682 die temperature reaches 170°C, the LM4682 disables the output switching waveform and remains disabled until the die temperature falls below 140°C (typ).

### Over-Modulation Protection

The LM4682's over-modulation protection is a result of the preamplifier's (AMP1 and AMP2, Figure 1) inability to produce signal magnitudes that equal the power supply voltages. Since the preamplifier's output magnitude will always be less than the supply voltage, the duty cycle of the amplifier's switching output will never reach zero. Peak modulation is limited to a nominal 95%.

### DC Volume Control

The LM4682 has an internal stereo volume control whose setting is a function of the DC voltage applied to the volume control pin VOLCTL.

The LM4682 volume control consists of 31 steps, which are individually selected by a variable DC voltage level on the VOLCTL pin. The gain range of Class D amplifiers are from -48dB to 30dB. The gain range of headphone amplifiers are from -65dB to 13dB. Each gain step corresponds to specific input voltage of both Class D amplifiers and headphone amplifiers are shown in Table 2.

To minimize the effect of noise on the volume control VOLCTL pin, which can affect the selected gain level, hysteresis has been implemented. The amount of hysteresis corresponds to half of the step width. For highest accuracy, the voltage shown in the "recommended voltage" column of the table is used to select a desired gain. The recommended voltage is exactly halfway between the two closest transitions to the next highest or next lowest gain levels.

## General Features (Continued)

**TABLE 2. Volume Control Table**

Step	Voltage Range (% of VOLVDD)			Voltage Range (V), VOLVDD = 5V			Gain (dB)	
	Low (%)	High (%)	Recommended (%)	Low (%)	High (%)	Recommended (%)	Class D Output	HP Output
1	77.50%	100.00%	100.000%	3.875	5.000	5.000	29.97	13.06
2	75.00%	78.50%	76.875%	3.750	3.925	3.844	28.97	12.07
3	72.50%	76.25%	74.375%	3.625	3.813	3.719	27.97	11.07
4	70.00%	73.75%	71.875%	3.500	3.688	3.594	26.96	10.06
5	67.50%	71.25%	69.375%	3.375	3.563	3.469	25.98	9.07
6	65.00%	68.75%	66.875%	3.250	3.438	3.344	24.97	8.07
7	62.50%	66.25%	64.375%	3.125	3.313	3.219	23.95	7.05
8	60.00%	63.75%	61.875%	3.000	3.188	3.094	21.98	5.08
9	57.50%	61.25%	59.375%	2.875	3.063	2.969	19.95	3.05
10	55.00%	58.75%	56.785%	2.750	2.983	2.844	17.96	1.06
11	52.50%	56.25%	54.375%	2.625	2.813	2.719	15.97	-0.93
12	50.00%	53.75%	51.875%	2.500	2.688	2.594	13.99	-2.91
13	47.50%	51.25%	49.375%	2.375	2.563	2.469	11.99	-4.91
14	45.00%	48.75%	46.875%	2.250	2.438	2.344	9.95	-6.96
15	42.50%	46.25%	44.375%	2.125	2.313	2.219	7.96	-8.94
16	40.00%	43.75%	41.875%	2.000	2.188	2.094	5.96	-10.95
17	37.50%	41.25%	39.375%	1.875	2.063	1.969	3.99	-12.91
18	35.00%	38.75%	36.875%	1.750	1.938	1.844	2.03	-14.87
19	32.50%	36.25%	34.375%	1.625	1.813	1.719	-0.02	-16.92
20	30.00%	33.75%	31.875%	1.500	1.688	1.594	-2.11	-19.02
21	27.50%	31.25%	29.375%	1.375	1.563	1.469	-4.16	-21.06
22	25.00%	28.75%	26.875%	1.250	1.438	1.344	-5.97	-22.87
23	22.50%	26.25%	24.375%	1.125	1.313	1.219	-8.77	-25.68
24	20.00%	23.75%	21.875%	1.000	1.188	1.094	-12.06	-28.96
25	17.50%	21.25%	19.375%	0.875	1.063	0.969	-14.84	-31.75
26	15.00%	18.75%	16.875%	0.750	0.938	0.844	-17.36	-34.26
27	12.50%	16.25%	14.375%	0.625	0.813	0.719	-20.89	-37.79
28	10.00%	13.75%	11.875%	0.500	0.688	0.594	-26.92	-43.83
29	7.50%	11.25%	9.375%	0.375	0.563	0.469	-32.95	-49.85
30	5.00%	8.75%	6.875%	0.250	0.438	0.344	-38.97	-55.88
31	0.00%	6.25%	0.000%	0.000	0.313	0.000	-48.03	-64.94

## Application Hints

### SUPPLY BYPASSING

The major source of noises to be taken care and applying bypassing technique in using LM4682 are those transients response coming from its output stage. During the switching operations of the output stage of LM4682, the switching frequencies vary when the internal modulator react to the input signals. This creates a band of switching transients giving back to the power supply terminals of LM4682. A single capacitor may not bypass those transients well. Two capacitors which values are closed to each other are used to bypass this range of frequencies to the ground. 10 $\mu$ F tantalum capacitors and 4.7 $\mu$ F ceramic capacitors are needed for this kind of decoupling of LM4682 switching operation. This results an improvement in terms of both stability and audio performance of LM4682. In addition, these capacitors should be placed as close as possible to each IC's supply pin(s) using leads as short as possible. Apart from the power supply de-coupling capacitors, the four bootstrapping capacitors (at pins BST1\_A, BST2\_A, BST1\_B and BST2\_B) should also be placed close to their corresponding pins. This could minimize the undesirable switching noise coupled to the supply rail.

The LM4682 has two different sets of  $V_{DD}$  pins: a set for power  $V_{DD}$  (PV<sub>DD\_A</sub> and P V<sub>DD\_B</sub>) and a set for signal  $V_{DD}$  (A and HP\_  $V_{DD}$ ). The parallel combination of the low value ceramic (4.7 $\mu$ F) and high value tantalum (10 $\mu$ F) should be used to bypass the power  $V_{DD}$  pins. A small value (1 $\mu$ F) ceramic or tantalum can be used to bypass the signal  $V_{DD}$  (A and HP\_  $V_{DD}$  pin).

### OUTPUT STAGE FILTERING

The LM4682 requires a low pass filter connected between the amplifier's bridge output and the load. Figure 1 shows the recommended LC filter. A minimum value of 22 $\mu$ H is recommended. As shown in Figure 1, using the values of the components connected between the amplifier BTL outputs and the load achieves a 2nd-order lowpass filter response which optimizes the amplifier's performance within the audio band.

### THD+N MEASUREMENTS AND OUT OF AUDIO BAND NOISE

THD+N (Total Harmonic Distortion plus Noise) is a very important parameter by which all audio amplifiers are measured. Often it is shown as a graph where either the output power or frequency is changed over the operating range. A very important variable in the measurement of THD+N is the bandwidth-limiting filter at the input of the test equipment. Class D amplifiers, by design, switch their output power devices at a much higher frequency than the accepted audio range (20Hz - 20kHz). Alternately switching the output voltage between  $V_{DD}$  and GND allows the LM4682 to operate at much higher efficiency than that achieved by traditional Class AB amplifiers. Switching the outputs at high frequency also increases the out-of-band noise. Under normal circumstances the output lowpass filter significantly reduces this out-of-band noise. If the low pass filter is not optimized for a given switching frequency, there can be significant increase in out-of-band noise. THD+N measurements can be significantly affected by out-of-band noise, resulting in a higher than expected THD+N measurement. To achieve a more accurate measurement of THD, the test equipment's input bandwidth of the must be limited. Some common upper filter points are 22kHz, 30kHz, and 80kHz. The input filter limits the noise component of the THD+N measurement to a smaller bandwidth resulting in a more real-world THD+N value.

### RECOMMENDED PRINTED CIRCUIT BOARD LAYOUT

Figures 2 through 6 show the recommended four-layer PCB board layout that is optimized for the 48-pin LLP packaged LM4682 and associated external components. This circuit is designed for use with an external 12V supply and 8 $\Omega$  speakers (or load resistors). Apply 12V and ground to board's  $V_{DD}$  and GND terminals respectively. And apply 5V to the VOLV<sub>DD</sub> (refer to power supply sequencing for details). Connect speakers (or load resistors) between the board's OUTA+ and OUTA-, and between the board's OUTB+ and OUTB-. Apply the stereo input signals to IN\_A and IN\_B. When designing the layout of the PCB layout, please pay attention to the output terminals of LM4682.





# Application Hints (Continued)

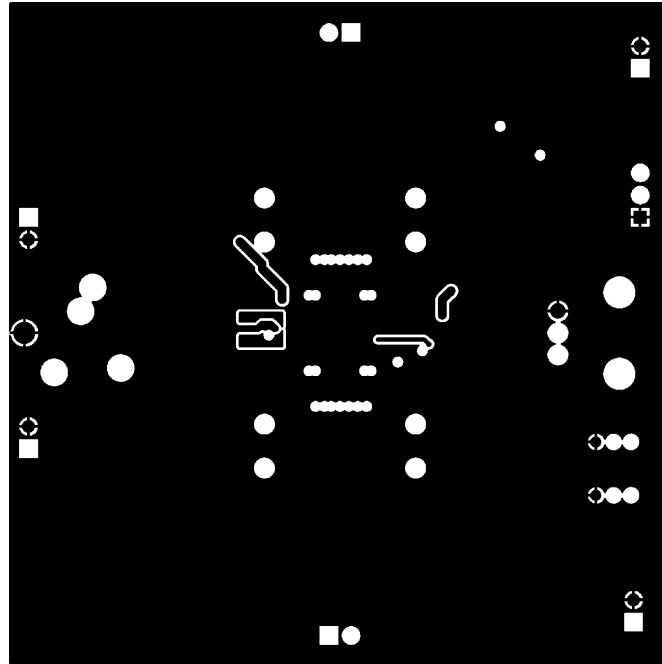

Figure 4: Upper Middle Layer

20119623

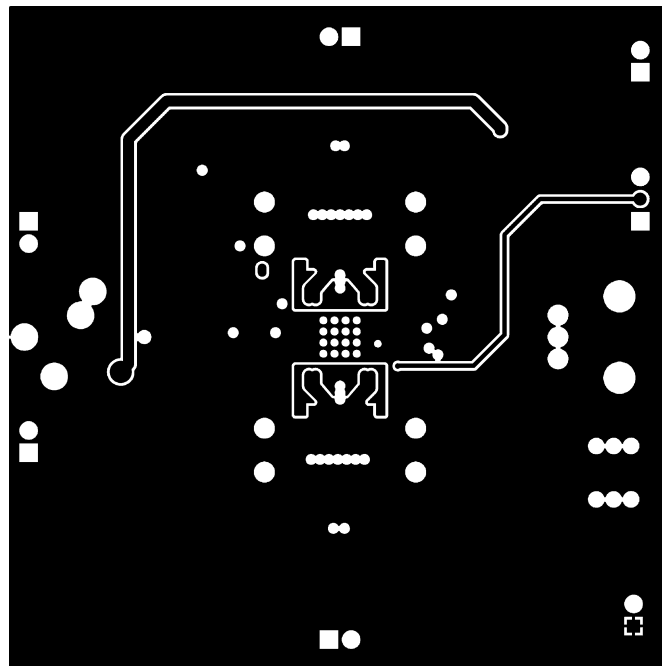
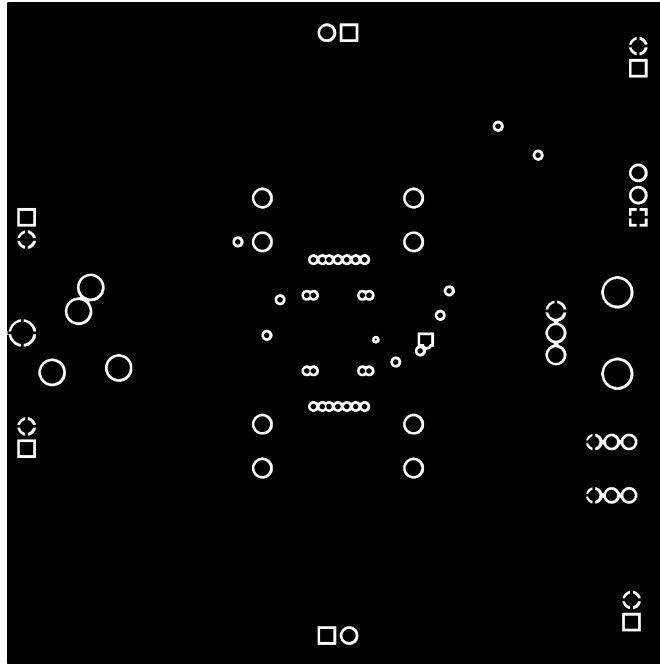

Figure 5: Lower Middle Layer

20119624

# Application Hints (Continued)



20119625

Figure 6: Bottom Layer

## Revision History

Rev	Date	Description
1.0	02/22/06	Initial WEB release of the document.
1.1	02/24/06	Edited art 201196 71 (changed the y-axis unit from mA to mW).
1.2	03/08/06	Did few texts clean-up and re-released D/S to the WEB (per Kevin H.).
1.3	06/29/06	Added 2 columns on ( Gain dB) Table 2 and re-released the D/S to the WEB (per Alex CK Wong).

**Physical Dimensions** inches (millimeters) unless otherwise noted

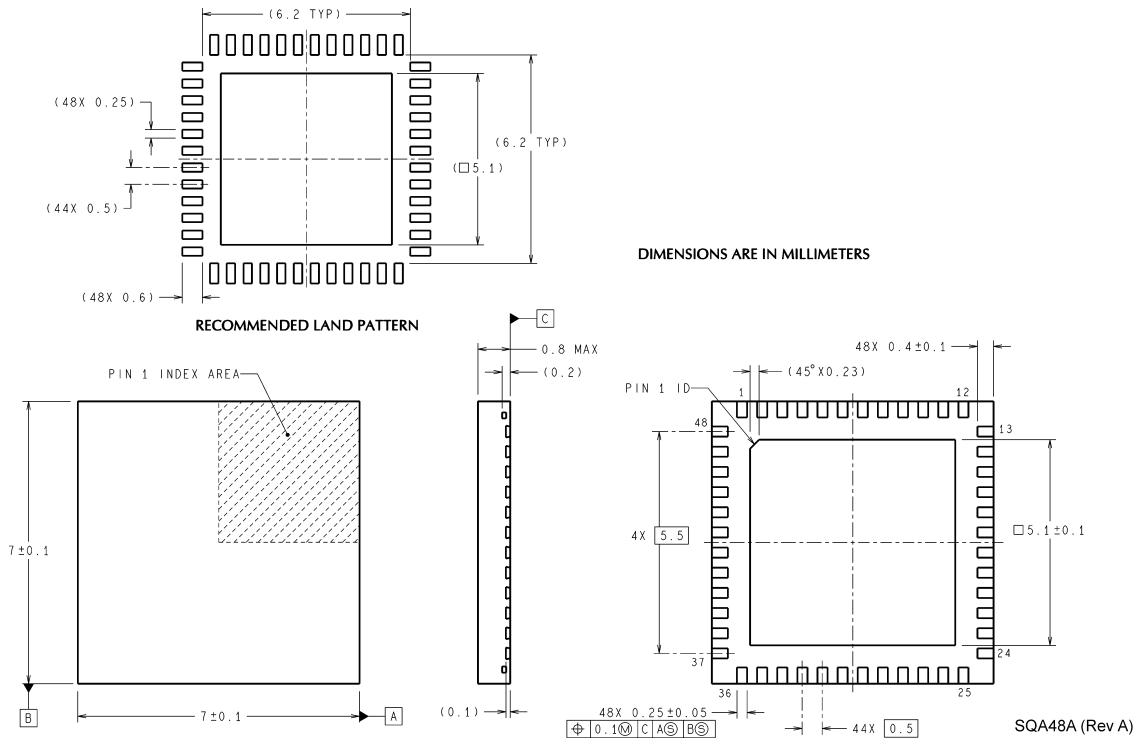

**Order Number LM4682SQ**  
**NS Package Number SQA48A**

National does not assume any responsibility for use of any circuitry described, no circuit patent licenses are implied and National reserves the right at any time without notice to change said circuitry and specifications.

For the most current product information visit us at [www.national.com](http://www.national.com).

**LIFE SUPPORT POLICY**

NATIONAL'S PRODUCTS ARE NOT AUTHORIZED FOR USE AS CRITICAL COMPONENTS IN LIFE SUPPORT DEVICES OR SYSTEMS WITHOUT THE EXPRESS WRITTEN APPROVAL OF THE PRESIDENT AND GENERAL COUNSEL OF NATIONAL SEMICONDUCTOR CORPORATION. As used herein:

1. Life support devices or systems are devices or systems which, (a) are intended for surgical implant into the body, or (b) support or sustain life, and whose failure to perform when properly used in accordance with instructions for use provided in the labeling, can be reasonably expected to result in a significant injury to the user.
2. A critical component is any component of a life support device or system whose failure to perform can be reasonably expected to cause the failure of the life support device or system, or to affect its safety or effectiveness.

**BANNED SUBSTANCE COMPLIANCE**

National Semiconductor follows the provisions of the Product Stewardship Guide for Customers (CSP-9-111C2) and Banned Substances and Materials of Interest Specification (CSP-9-111S2) for regulatory environmental compliance. Details may be found at: [www.national.com/quality/green](http://www.national.com/quality/green).

Lead free products are RoHS compliant.



**National Semiconductor**  
**Americas Customer Support Center**  
 Email: [new.feedback@nsc.com](mailto:new.feedback@nsc.com)  
 Tel: 1-800-272-9959

**National Semiconductor**  
**Europe Customer Support Center**  
 Fax: +49 (0) 180-530 85 86  
 Email: [europe.support@nsc.com](mailto:europe.support@nsc.com)  
 Deutsch Tel: +49 (0) 69 9508 6208  
 English Tel: +44 (0) 870 24 0 2171  
 Français Tel: +33 (0) 1 41 91 8790

**National Semiconductor**  
**Asia Pacific Customer Support Center**  
 Email: [ap.support@nsc.com](mailto:ap.support@nsc.com)

**National Semiconductor**  
**Japan Customer Support Center**  
 Fax: 81-3-5639-7507  
 Email: [jpn.feedback@nsc.com](mailto:jpn.feedback@nsc.com)  
 Tel: 81-3-5639-7560

[www.national.com](http://www.national.com)