

DM74LS465 (DM81LS95A)/DM74LS466 (DM81LS96A)/ DM74LS467 (DM81LS97A)/DM74LS468 (DM81LS98A) TRI-STATE® Octal Buffer

General Description

These devices provide eight, two-input buffers in each package. All employ the newest low-power-Schottky TTL technology. One of the two inputs to each buffer is used as a control line to gate the output into the high-impedance state, while the other input passes the data through the buffer. The 'LS465 and 'LS467 present true data at the outputs, while the 'LS466 and 'LS468 are inverting. On the 'LS465 and 'LS466 versions, all eight TRI-STATE enable lines are common, with access through a 2-input NOR gate. On the 'LS467 and 'LS468 versions, four buffers are enabled from one common line, and the other four buffers are enabled from another common line. In all cases the outputs are placed in the TRI-STATE condition by applying a high logic level to the enable pins. These devices represent octal, low

power-Schottky versions of the very popular DM54/74365, 366, 367, and 368 (DM8095, 96, 97, and 98) TRI-STATE hex buffers.

Features

- Octal versions of popular DM74365, 366, 367, and 368 (DM8095, 96, 97 and 98)
- Typical power dissipation
 - LS465, 467, (LS95A, 97A) 80 mW
 - LS466, 468, (LS96A, 98A) 65 mW
- Typical propagation delay
 - LS465, 467 (LS95A, 97A) 15 ns
 - LS466, 468 (LS96A, 98A) 10 ns
- Low power-Schottky, TRI-STATE technology

Connection Diagrams

Dual-In-Line Packages

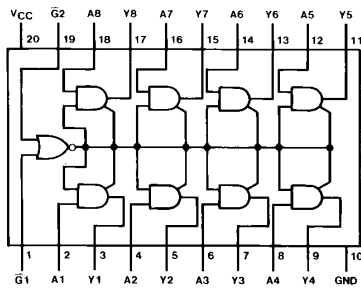

TL/F/6435-1

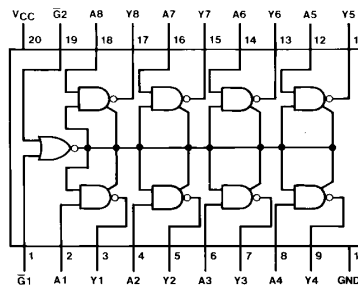

TL/F/6435-2

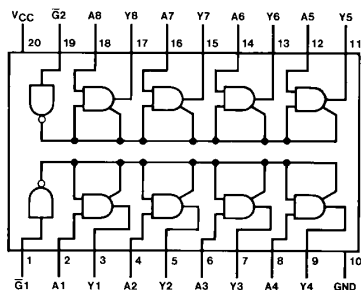

TL/F/6435-3

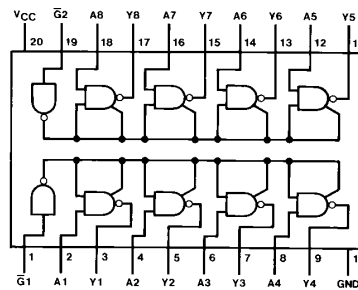

TL/F/6435-4

**Order Numbers DM74LS465WM/DM81LS95AWM, DM74LS465N/DM81LS95AN,
DM74LS466WM/DM81LS96AWM, DM74LS466N/DM81LS96AN,
DM74LS467WM/DM81LS97AWM, DM74LS467N/DM81LS97AN,
DM74LS468WM/DM81LS98AWM or DM74LS468N/DM81LS98AN
See NS Package Number M20B or N20A**

TRI-STATE® is a registered trademark of National Semiconductor Corporation.

DM74LS465 (DM81LS95A)/DM74LS466 (DM81LS96A)/DM74LS467 (DM81LS97A)/
DM74LS468 (DM81LS98A) TRI-STATE Octal Buffer

Absolute Maximum Ratings (Note)

Supply Voltage	7V
Input Voltage	7V
Operating Free Air Temperature Range DM74LS/DM81LS	0°C to +70°C
Storage Temperature Range	-65°C to +150°C

Note: The "Absolute Maximum Ratings" are those values beyond which the safety of the device cannot be guaranteed. The device should not be operated at these limits. The parametric values defined in the "Electrical Characteristics" table are not guaranteed at the absolute maximum ratings. The "Recommended Operating Conditions" table will define the conditions for actual device operation.

Recommended Operating Conditions

Symbol	Parameter	Min	Nom	Max	Units
V _{CC}	Supply Voltage	4.75	5	5.25	V
V _{IH}	High Level Input Voltage	2			V
V _{IL}	Low Level Input Voltage			0.8	V
I _{OH}	High Level Output Current			-5.2	mA
I _{OL}	Low Level Output Current			24	mA
T _A	Free Air Operating Temperature	0		70	°C

'LS465 ('LS95A) and 'LS467 ('LS97A) Electrical Characteristics

over recommended operating free air temperature range (unless otherwise noted)

Symbol	Parameter	Conditions	Min	Typ (Note 1)	Max	Units	
V _I	Input Clamp Voltage	V _{CC} = Min, I _I = -18 mA			-1.5	V	
V _{OH}	High Level Output Voltage	V _{CC} = Min, I _{OH} = Max V _{IL} = Max, V _{IH} = Min	2.7			V	
V _{OL}	Low Level Output Voltage	V _{CC} = Min, I _{OL} = Max V _{IL} = Max, V _{IH} = Min			0.5	V	
		I _{OL} = 12 mA, V _{CC} = Min			0.4		
I _I	Input Current @Max Input Voltage	V _{CC} = Max, V _I = 7V			0.1	mA	
I _{IH}	High Level Input Current	V _{CC} = Max, V _I = 2.7V			20	μA	
I _{IL}	Low Level Input Current	V _{CC} = Max	V _I = 0.5V	A (Note 3)		-20	μA
			V _I = 0.4V	A (Note 4)		-50	
			\bar{G}			-50	
I _{OZH}	Off-State Output Current with High Level Output Voltage Applied	V _{CC} = Max, V _O = 2.4V V _{IH} = Min, V _{IL} = Max			20	μA	
I _{OZL}	Off-State Output Current with Low Level Output Voltage Applied	V _{CC} = Max, V _O = 0.4V V _{IH} = Min, V _{IL} = Max			-20	μA	
I _{OS}	Short Circuit Output Current	V _{CC} = Max (Note 2)	-20		-100	mA	
I _{CC}	Supply Current	V _{CC} = Max (Note 3)		16	26	mA	

Note 1: All typicals are at V_{CC} = 5V, T_A = 25°C.

Note 2: Not more than one output should be shorted at a time, and the duration should not exceed one second.

Note 3: Both \bar{G} inputs are at 2V.

Note 4: Both \bar{G} inputs are at 0.4V.

'LS465 and 'LS467 Switching Characteristics

$V_{CC} = 5V$, $T_A = 25^\circ C$

Symbol	Parameter	$R_L = 667\Omega$				Units
		$C_L = 50\text{ pF}$		$C_L = 150\text{ pF}$		
		Min	Max	Min	Max	
t_{PLH}	Propagation Delay Time Low to High Level Output		16		25	ns
t_{PHL}	Propagation Delay Time High to Low Level Output		28		40	ns
t_{PZH}	Output Enable Time to High Level Output		25		30	ns
t_{PZL}	Output Enable Time to Low Level Output		30		42	ns
t_{PHZ}	Output Disable Time from High Level Output (Note 1)		20			ns
t_{PLZ}	Output Disable Time from Low Level Output (Note 1)		27			ns

Note 1: $C_L = 5\text{ pF}$.

'LS466 ('LS96A) and 'LS468 ('LS98A) Electrical Characteristics

over recommended operating free air temperature range (unless otherwise noted)

Symbol	Parameter	Conditions	Min	Typ (Note 2)	Max	Units	
V_I	Input Clamp Voltage	$V_{CC} = \text{Min}$, $I_I = -18\text{ mA}$			-1.5	V	
V_{OH}	High Level Output Voltage	$V_{CC} = \text{Min}$, $I_{OH} = \text{Max}$ $V_{IL} = \text{Max}$, $V_{IH} = \text{Min}$	2.7			V	
V_{OL}	Low Level Output Voltage	$V_{CC} = \text{Min}$, $I_{OL} = \text{Max}$ $V_{IL} = \text{Max}$, $V_{IH} = \text{Min}$			0.5	V	
		$I_{OL} = 12\text{ mA}$, $V_{CC} = \text{Min}$			0.4		
I_I	Input Current @Max Input Voltage	$V_{CC} = \text{Max}$, $V_I = 7V$			0.1	mA	
I_{IH}	High Level Input Current	$V_{CC} = \text{Max}$, $V_I = 2.7V$			20	μA	
I_{IL}	Low Level Input Current	$V_{CC} = \text{Max}$	$V_I = 0.5V$	A (Note 4)		-20	μA
			$V_I = 0.4V$	A (Note 5)		-50	
			\bar{G}			-50	
I_{OZH}	Off-State Output Current with High Level Output Voltage Applied	$V_{CC} = \text{Max}$, $V_O = 2.4V$ $V_{IH} = \text{Min}$, $V_{IL} = \text{Max}$			20	μA	
I_{OZL}	Off-State Output Current with Low Level Output Voltage Applied	$V_{CC} = \text{Max}$, $V_O = 0.4V$ $V_{IH} = \text{Min}$, $V_{IL} = \text{Max}$			-20	μA	
I_{OS}	Short Circuit Output Current	$V_{CC} = \text{Max}$ (Note 3)	-20		-100	mA	
I_{CC}	Supply Current	$V_{CC} = \text{Max}$ (Note 5)		13	21	mA	

Note 2: All typicals are at $V_{CC} = 5V$, $T_A = 25^\circ C$.

Note 3: Not more than one output should be shorted at a time, and the duration should not exceed one second.

Note 4: Both \bar{G} inputs are at 2V.

Note 5: Both \bar{G} inputs are at 0.4V.

'LS466 and 'LS468 Switching Characteristics

for test waveforms and output load. $V_{CC} = 5V$, $T_A = 25^\circ C$

Symbol	Parameter	$R_L = 667\Omega$				Units
		$C_L = 50\text{ pF}$		$C_L = 150\text{ pF}$		
		Min	Max	Min	Max	
t_{PLH}	Propagation Delay Time Low to High Level Output		10		16	ns
t_{PHL}	Propagation Delay Time High to Low Level Output		17		30	ns
t_{PZH}	Output Enable Time to High Level Output		15		30	ns
t_{PZL}	Output Enable Time to Low Level Output		35		45	ns
t_{PHZ}	Output Disable Time from High Level Output (Note 1)		20			ns
t_{PLZ}	Output Disable Time from Low Level Output (Note 1)		27			ns

Note 1: $C_L = 5\text{ pF}$.

Function Tables

LS465 (LS95A)

Inputs			Output Y
$\overline{G}1$	$\overline{G}2$	A	
H	X	X	Hi-Z
X	H	X	Hi-Z
L	L	H	H
L	L	L	L

LS466 (LS96A)

Inputs			Output Y
$\overline{G}1$	$\overline{G}2$	A	
H	X	X	Hi-Z
X	H	X	Hi-Z
L	L	H	L
L	L	L	H

LS467 (LS97A)

Inputs		Output Y
\overline{G}	A	
H	X	Hi-Z
L	H	H
L	L	L

LS468 (LS98A)

Inputs		Output Y
\overline{G}	A	
H	X	Hi-Z
L	H	L
L	L	H

H = High Logic Level

L = Low Logic Level

X = Either High or Low Logic Level

Hi-Z = High Impedance (Off) State

Physical Dimensions inches (millimeters)

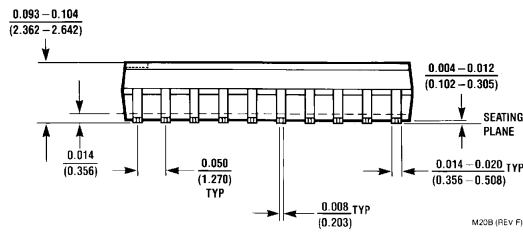
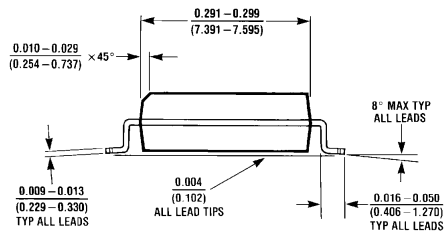
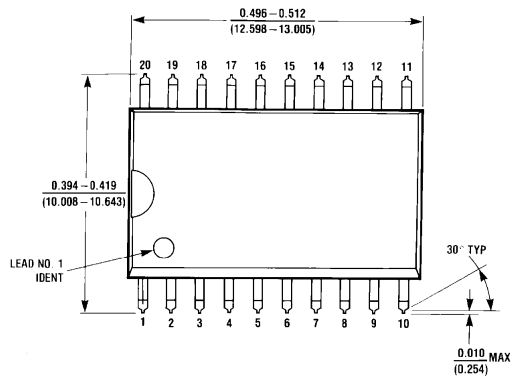

20-Lead Wide Small Outline Molded Package (M)
Order Numbers DM74LS465WM/DM81LS95AWM, DM74LS466WM/DM81LS96AWM,
DM74LS467WM/DM81LS97AWM or DM74LS468WM/DM81LS98AWM
NS Package Number M20B

M20B (REV. F)

Physical Dimensions inches (millimeters) (Continued)

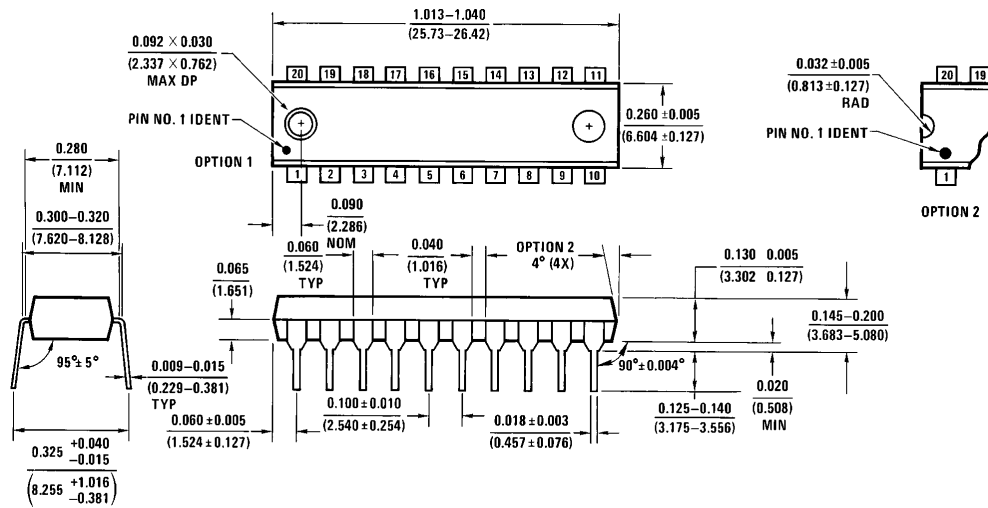

N20A (REV G)

20-Lead Molded Dual-In-Line Package (N)
Order Numbers DM74LS465N/DM81LS95AN, DM74LS466N/DM81LS96AN,
DM74LS467N/DM81LS97AN or DM74LS468N/DM81LS98AN
NS Package Number N20A

LIFE SUPPORT POLICY

NATIONAL'S PRODUCTS ARE NOT AUTHORIZED FOR USE AS CRITICAL COMPONENTS IN LIFE SUPPORT DEVICES OR SYSTEMS WITHOUT THE EXPRESS WRITTEN APPROVAL OF THE PRESIDENT OF NATIONAL SEMICONDUCTOR CORPORATION. As used herein:

1. Life support devices or systems are devices or systems which, (a) are intended for surgical implant into the body, or (b) support or sustain life, and whose failure to perform, when properly used in accordance with instructions for use provided in the labeling, can be reasonably expected to result in a significant injury to the user.
2. A critical component is any component of a life support device or system whose failure to perform can be reasonably expected to cause the failure of the life support device or system, or to affect its safety or effectiveness.



National Semiconductor Corporation
 1111 West Bardin Road
 Arlington, TX 76017
 Tel: 1(800) 272-9959
 Fax: 1(800) 737-7018

National Semiconductor Europe
 Fax: (+49) 0-180-530 85 86
 Email: onjwge@tevm2.nsc.com
 Deutsch Tel: (+49) 0-180-530 85 85
 English Tel: (+49) 0-180-532 78 32
 Français Tel: (+49) 0-180-532 93 58
 Italiano Tel: (+49) 0-180-534 16 80

National Semiconductor Hong Kong Ltd.
 19th Floor, Straight Block,
 Ocean Centre, 5 Canton Rd.
 Tsimshatsui, Kowloon
 Hong Kong
 Tel: (852) 2737-1600
 Fax: (852) 2736-9960

National Semiconductor Japan Ltd.
 Tel: 81-043-299-2309
 Fax: 81-043-299-2408

National does not assume any responsibility for use of any circuitry described, no circuit patent licenses are implied and National reserves the right at any time without notice to change said circuitry and specifications.