

LM4808 Boomer[®] Audio Power Amplifier Series

Dual 105 mW Headphone Amplifier

General Description

The LM4808 is a dual audio power amplifier capable of delivering 105mW per channel of continuous average power into a 16Ω load with 0.1% (THD+N) from a 5V power supply. Boomer audio power amplifiers were designed specifically to provide high quality output power with a minimal amount of external components using surface mount packaging. Since the LM4808 does not require bootstrap capacitors or snubber networks, it is optimally suited for low-power portable systems.

The unity-gain stable LM4808 can be configured by external gain-setting resistors.

Key Specifications

- THD+N at 1kHz at 105mW continuous average output power into 16Ω 0.1% (typ)
- THD+N at 1kHz at 70mW continuous average output power into 32Ω 0.1% (typ)
- Output power at 0.1% THD+N at 1kHz into 32Ω 70mW (typ)

Features

- LLP, MSOP, and SOP surface mount packaging
- Switch on/off click suppression
- Excellent power supply ripple rejection
- Unity-gain stable
- Minimum external components

Applications

- Headphone Amplifier
- Personal Computers
- Portable electronic devices

Typical Application

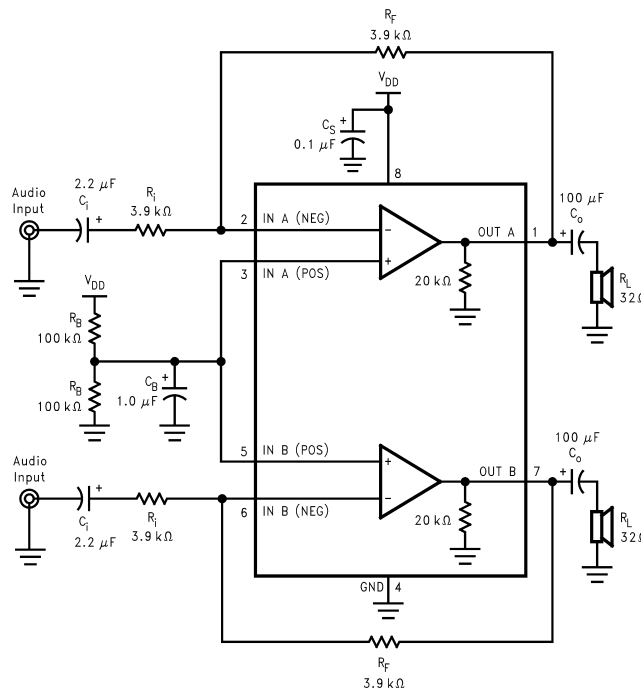

10127601

*Refer to the **Application Information** Section for information concerning proper selection of the input and output coupling capacitors.

FIGURE 1. Typical Audio Amplifier Application Circuit

Boomer[®] is a registered trademark of National Semiconductor Corporation.

Connection Diagrams

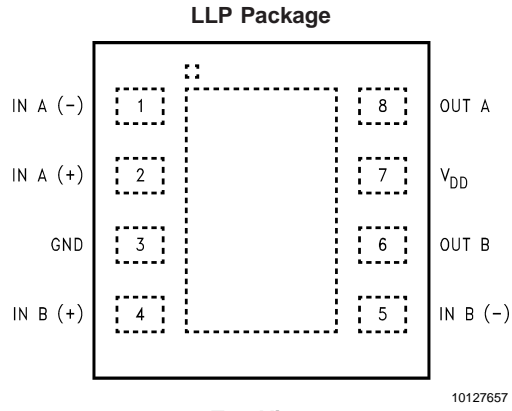

Top View
Order Number LM4808LD
See NS Package Number LDA08B

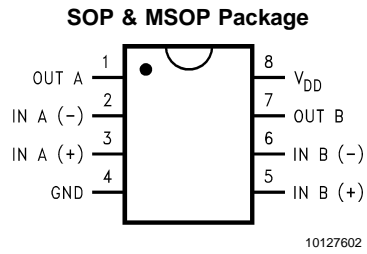

Top View
Order Number LM4808M, LM4808MM
See NS Package Number M08A, MUA08A

Absolute Maximum Ratings (Note 3)

If Military/Aerospace specified devices are required, please contact the National Semiconductor Sales Office/Distributors for availability and specifications.

Supply Voltage	6.0V
Storage Temperature	-65°C to +150°C
Input Voltage	-0.3V to $V_{DD} + 0.3V$
Power Dissipation (Note 4)	Internally limited
ESD Susceptibility (Note 5)	3500V
ESD Susceptibility (Note 6)	250V
Junction Temperature	150°C
Soldering Information (Note 1)	
Small Outline Package	
Vapor Phase (60 seconds)	215°C
Infrared (15 seconds)	220°C
Thermal Resistance	

θ_{JC} (MSOP)	56°C/W
θ_{JA} (MSOP)	210°C/W
θ_{JC} (SOP)	35°C/W
θ_{JA} (SOP)	170°C/W
θ_{JC} (LLP)	15°C/W
θ_{JA} (LLP)	117°C/W (Note 9)
θ_{JA} (LLP)	150°C/W (Note 10)

Operating Ratings

Temperature Range	
$T_{MIN} \leq T_A \leq T_{MAX}$	-40°C \leq T_A \leq 85°C
Supply Voltage	2.0V \leq V_{DD} \leq 5.5V

Note 1: See AN-450 "Surface Mounting and their Effects on Product Reliability" for other methods of soldering surface mount devices.

Electrical Characteristics (Notes 2, 3)

The following specifications apply for $V_{DD} = 5V$ unless otherwise specified, limits apply to $T_A = 25^\circ C$.

Symbol	Parameter	Conditions	LM4808		Units (Limits)
			Typ (Note 7)	Limit (Note 8)	
V_{DD}	Supply Voltage			2.0 5.5	V (min) V (max)
I_{DD}	Supply Current	$V_{IN} = 0V, I_O = 0A$	1.2	3.0	mA (max)
P_{tot}	Total Power Dissipation	$V_{IN} = 0V, I_O = 0A$	6	16.5	mW (max)
V_{OS}	Input Offset Voltage	$V_{IN} = 0V$	10	50	mV (max)
I_{bias}	Input Bias Current		10		pA
V_{CM}	Common Mode Voltage		0		V
			4.3		V
G_V	Open-Loop Voltage Gain	$R_L = 5k\Omega$	67		dB
I_O	Max Output Current	THD+N < 0.1 %	70		mA
R_O	Output Resistance		0.1		Ω
V_O	Output Swing	$R_L = 32\Omega, 0.1\% \text{ THD+N, Min}$.3		V
		$R_L = 32\Omega, 0.1\% \text{ THD+N, Max}$	4.7		
PSRR	Power Supply Rejection Ratio	$C_b = 1.0\mu F, V_{ripple} = 100mV_{PP}, f = 100Hz$	89		dB
Crosstalk	Channel Separation	$R_L = 32\Omega$	75		dB
THD+N	Total Harmonic Distortion + Noise	$f = 1 \text{ kHz}$			
		$R_L = 16\Omega, V_O = 3.5V_{PP}$ (at 0 dB)	0.05		%
		$R_L = 16\Omega, V_O = 3.5V_{PP}$ (at 0 dB)	66		dB
		$R_L = 32\Omega, V_O = 3.5V_{PP}$ (at 0 dB)	0.05		%
		$R_L = 32\Omega, V_O = 3.5V_{PP}$ (at 0 dB)	66		dB
SNR	Signal-to-Noise Ratio	$V_O = 3.5V_{PP}$ (at 0 dB)	105		dB
f_G	Unity Gain Frequency	Open Loop, $R_L = 5k\Omega$	5.5		MHz
P_O	Output Power	THD+N = 0.1%, $f = 1 \text{ kHz}$			
		$R_L = 16\Omega$	105		mW
		$R_L = 32\Omega$	70	60	mW
		THD+N = 10%, $f = 1 \text{ kHz}$			
		$R_L = 16\Omega$	150		mW
		$R_L = 32\Omega$	90		mW
C_I	Input Capacitance		3		pF

Electrical Characteristics (Notes 2, 3) (Continued)

The following specifications apply for $V_{DD} = 5V$ unless otherwise specified, limits apply to $T_A = 25^\circ C$.

Symbol	Parameter	Conditions	LM4808		Units (Limits)
			Typ (Note 7)	Limit (Note 8)	
C_L	Load Capacitance			200	pF
SR	Slew Rate	Unity Gain Inverting	3		V/ μ s

Electrical Characteristics (Notes 2, 3)

The following specifications apply for $V_{DD} = 3.3V$ unless otherwise specified, limits apply to $T_A = 25^\circ C$.

Symbol	Parameter	Conditions	Conditions		Units (Limits)
			Typ (Note 7)	Limit (Note 8)	
I_{DD}	Supply Current	$V_{IN} = 0V, I_O = 0A$	1.0		mA (max)
V_{OS}	Input Offset Voltage	$V_{IN} = 0V$	7		mV (max)
P_o	Output Power	THD+N = 0.1%, f = 1 kHz			
		$R_L = 16\Omega$	40		mW
		$R_L = 32\Omega$	28		mW
		THD+N = 10%, f = 1 kHz			
		$R_L = 16\Omega$	56		mW
		$R_L = 32\Omega$	38		mW

Electrical Characteristics (Notes 2, 3)

The following specifications apply for $V_{DD} = 2.6V$ unless otherwise specified, limits apply to $T_A = 25^\circ C$.

Symbol	Parameter	Conditions	Conditions		Units (Limits)
			Typ (Note 7)	Limit (Note 8)	
I_{DD}	Supply Current	$V_{IN} = 0V, I_O = 0A$	0.9		mA (max)
V_{OS}	Input Offset Voltage	$V_{IN} = 0V$	5		mV (max)
P_o	Output Power	THD+N = 0.1%, f = 1 kHz			
		$R_L = 16\Omega$	20		mW
		$R_L = 32\Omega$	16		mW
		THD+N = 10%, f = 1 kHz			
		$R_L = 16\Omega$	31		mW
		$R_L = 32\Omega$	22		mW

Note 2: All voltages are measured with respect to the ground pin, unless otherwise specified.

Note 3: *Absolute Maximum Ratings* indicate limits beyond which damage to the device may occur. *Operating Ratings* indicate conditions for which the device is functional, but do not guarantee specific performance limits. *Electrical Characteristics* state DC and AC electrical specifications under particular test conditions which guarantee specific performance limits. This assumes that the device is within the Operating Ratings. Specifications are not guaranteed for parameters where no limit is given, however, the typical value is a good indication of device performance.

Note 4: The maximum power dissipation must be derated at elevated temperatures and is dictated by T_{JMAX} , θ_{JA} , and the ambient temperature T_A . The maximum allowable power dissipation is $P_{DMAX} = (T_{JMAX} - T_A) / \theta_{JA}$. For the LM4808, $T_{JMAX} = 150^\circ C$, and the typical junction-to-ambient thermal resistance, when board mounted, is $210^\circ C/W$ for package MUA08A and $170^\circ C/W$ for package M08A.

Note 5: Human body model, 100 pF discharged through a 1.5 k Ω resistor.

Note 6: Machine Model, 220 pF–240 pF discharged through all pins.

Note 7: Typical values are measured at $25^\circ C$ and represent the parametric norm.

Note 8: Tested limits are guaranteed to National's AOQL (Average Outgoing Quality Level). Datasheet min/max specification limits are guaranteed by design, test, or statistical analysis.

Note 9: The given θ_{JA} is for an LM4808 packaged in an LDA08B with the Exposed-DAP soldered to a printed circuit board copper pad with an area equivalent to that of the Exposed-DAP itself.

Note 10: The given θ_{JA} is for an LM4808 packaged in an LDA08B with the Exposed-DAP not soldered to any printed circuit board copper.

External Components Description (Figure 1)

Components	Functional Description
1. R_i	The inverting input resistance, along with R_f , set the closed-loop gain. R_i , along with C_i , form a high pass filter with $f_c = 1/(2\pi R_i C_i)$.
2. C_i	The input coupling capacitor blocks DC voltage at the amplifier's input terminals. C_i , along with R_i , create a highpass filter with $f_c = 1/(2\pi R_i C_i)$. Refer to the section, Selecting Proper External Components , for an explanation of determining the value of C_i .
3. R_f	The feedback resistance, along with R_i , set closed-loop gain.
4. C_S	This is the supply bypass capacitor. It provides power supply filtering. Refer to the Application Information section for proper placement and selection of the supply bypass capacitor.
5. C_B	This is the half-supply bypass pin capacitor. It provides half-supply filtering. Refer to the section, Selecting Proper External Components , for information concerning proper placement and selection of C_B .
6. C_O	This is the output coupling capacitor. It blocks the DC voltage at the amplifier's output and forms a high pass filter with R_L at $f_o = 1/(2\pi R_L C_O)$
7. R_B	This is the resistor which forms a voltage divider that provides $1/2 V_{DD}$ to the non-inverting input of the amplifier.

Typical Performance Characteristics

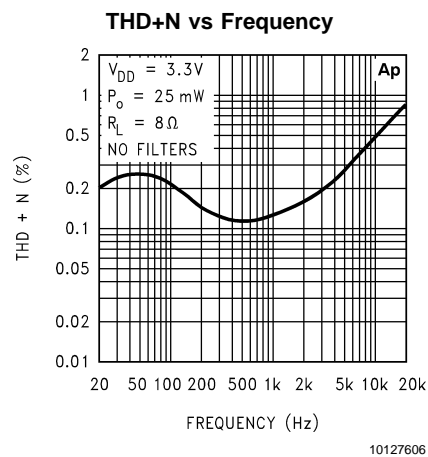
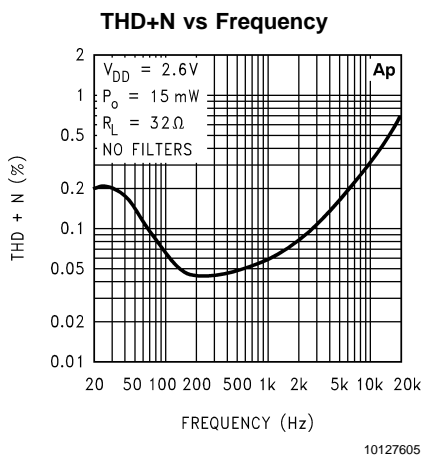
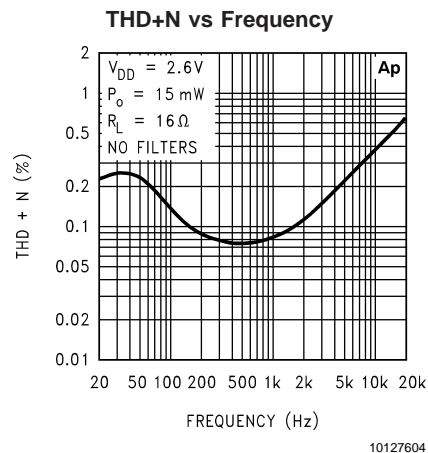
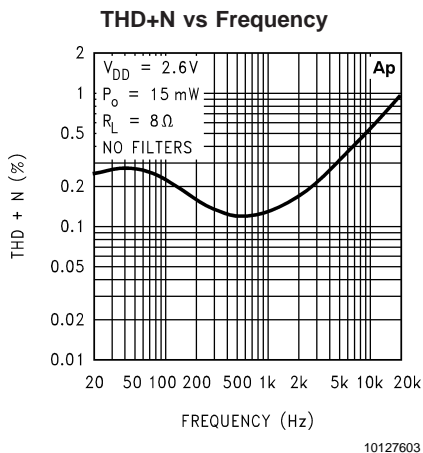

Typical Performance Characteristics (Continued)

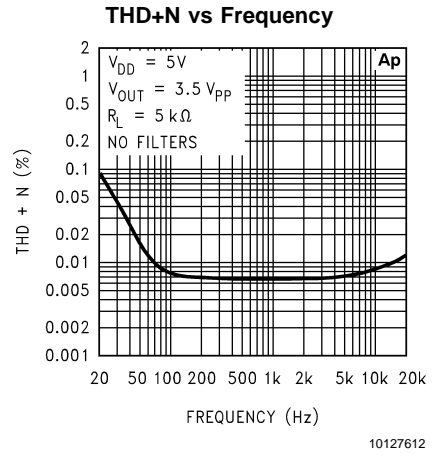
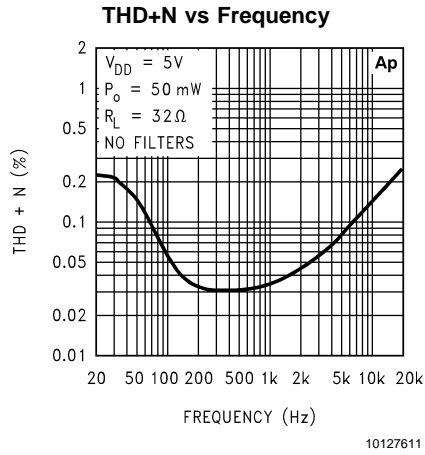
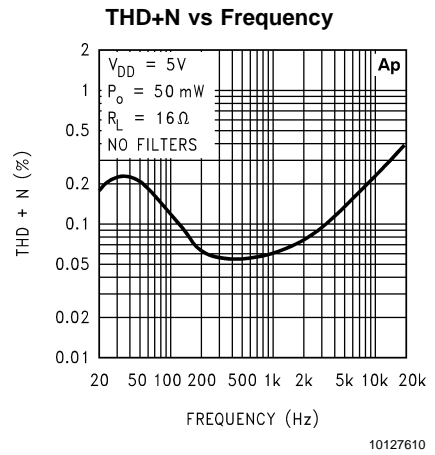
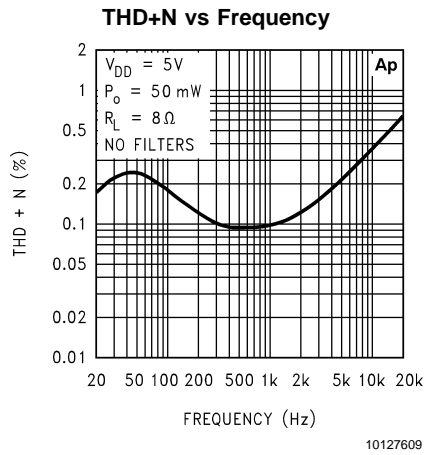
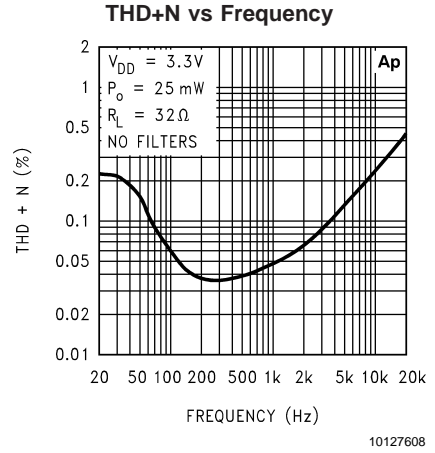
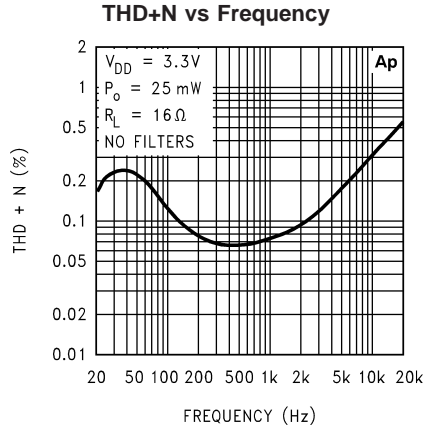

Typical Performance Characteristics (Continued)

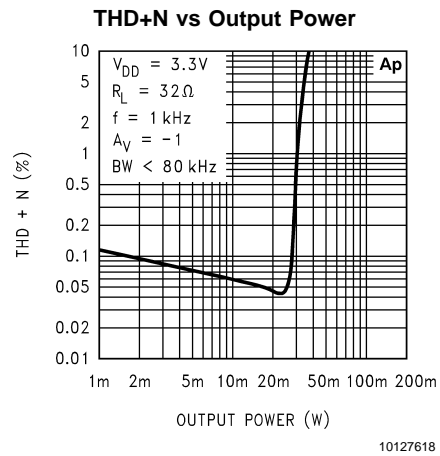
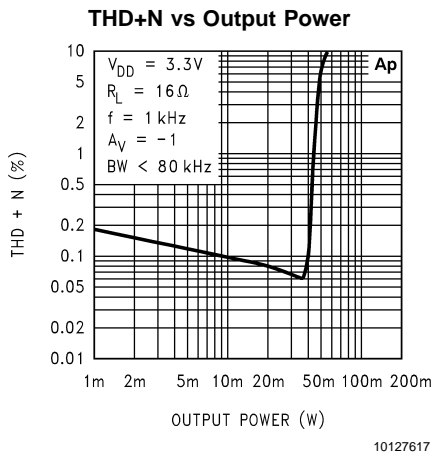
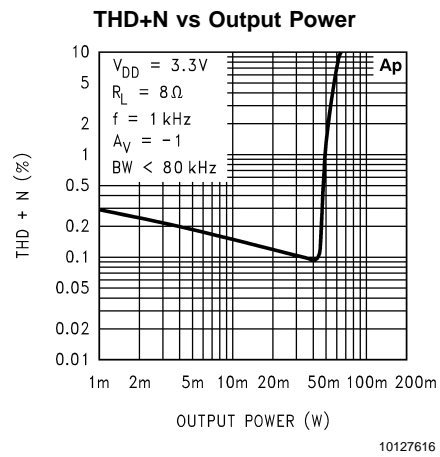
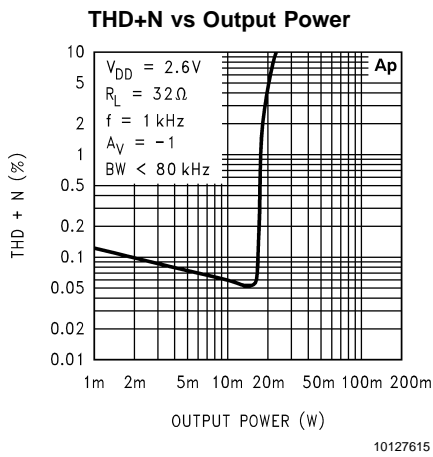
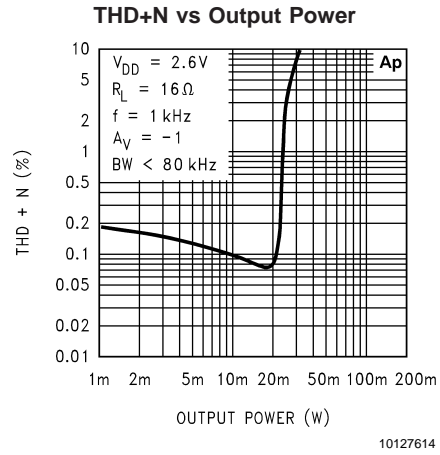
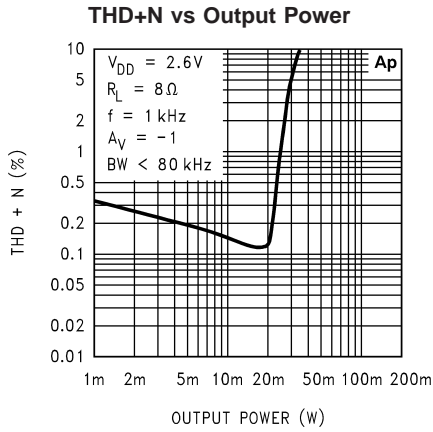

Typical Performance Characteristics (Continued)

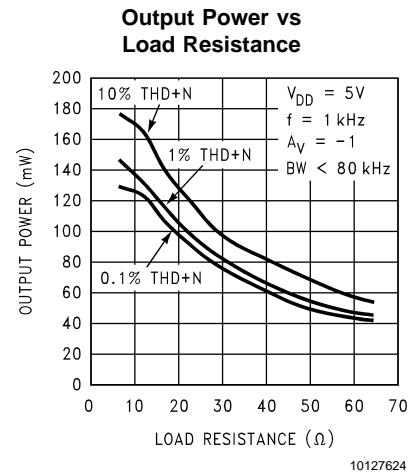
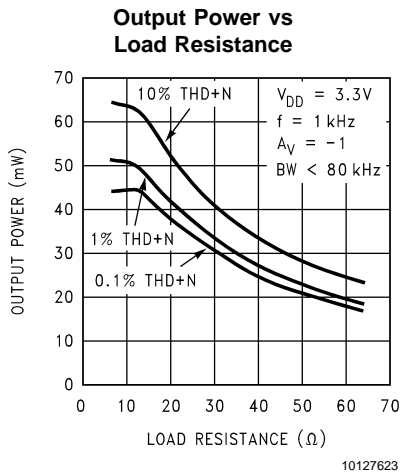
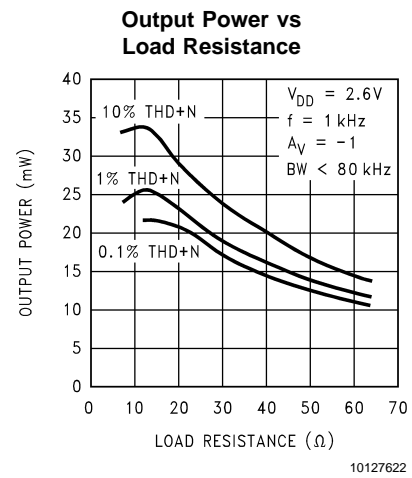
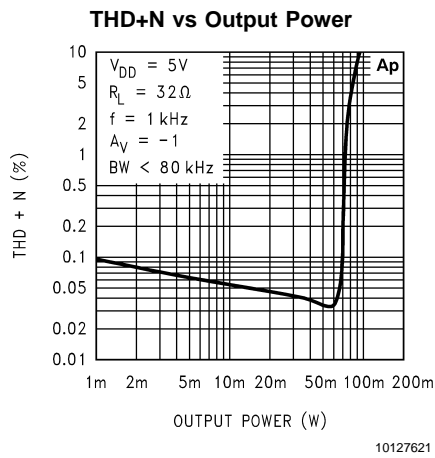
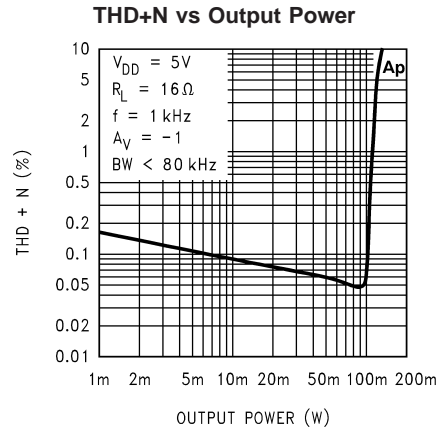
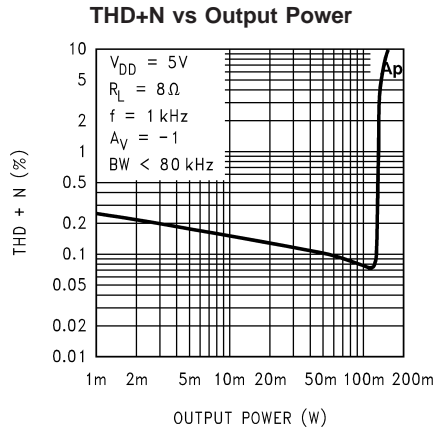

Typical Performance Characteristics (Continued)

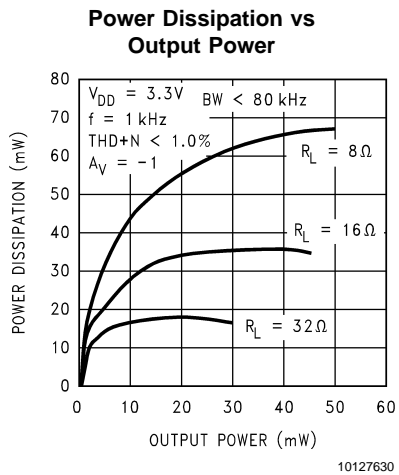
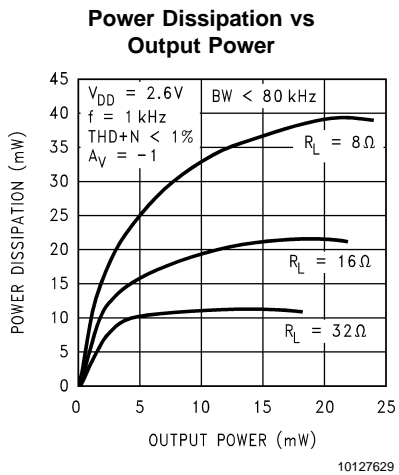
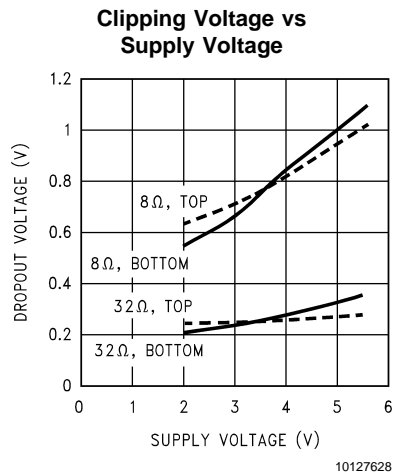
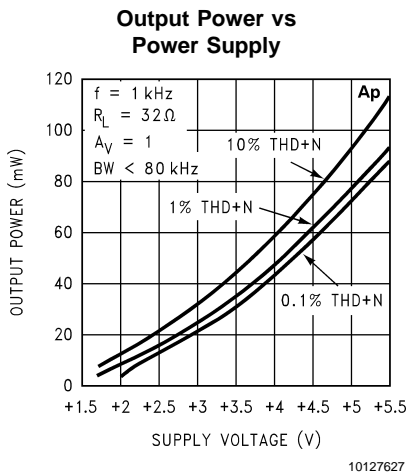
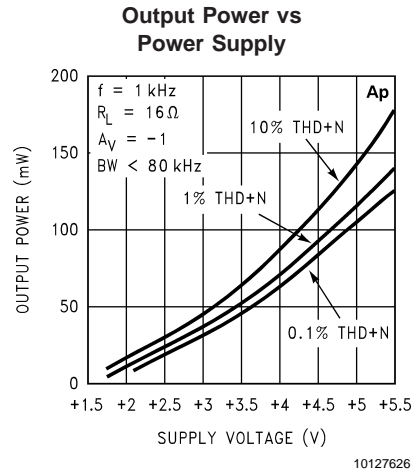
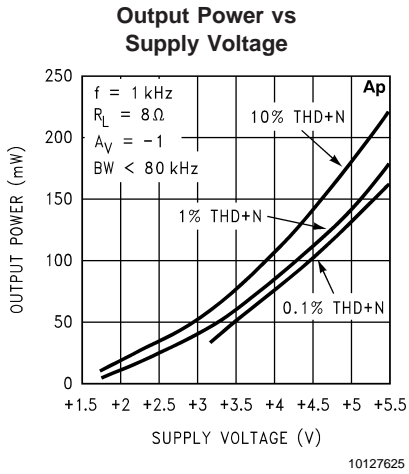

Typical Performance Characteristics (Continued)

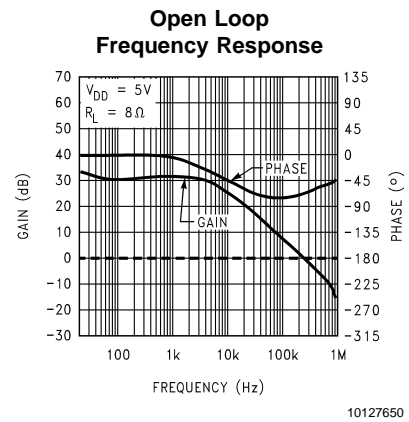
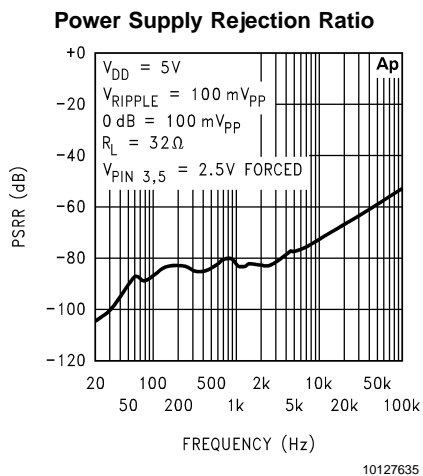
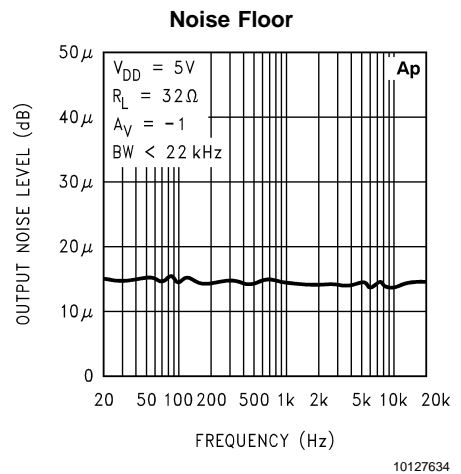
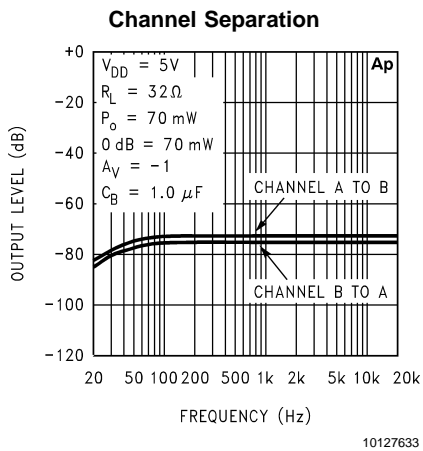
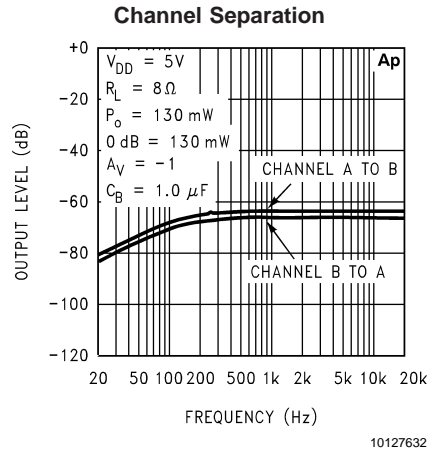
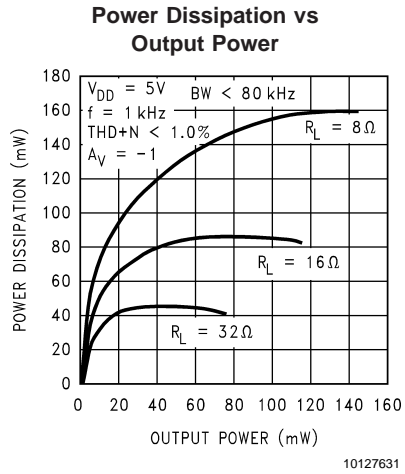

Typical Performance Characteristics (Continued)

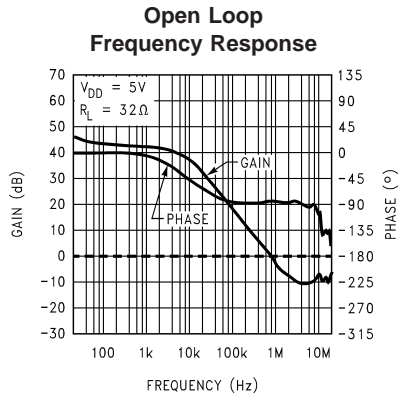

10127651

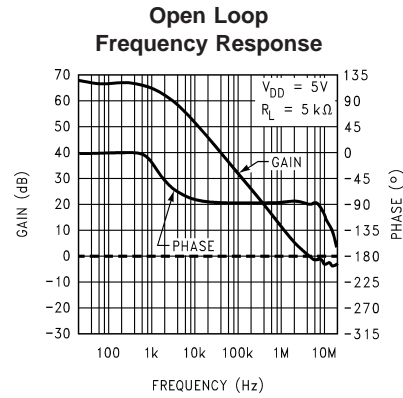

10127638

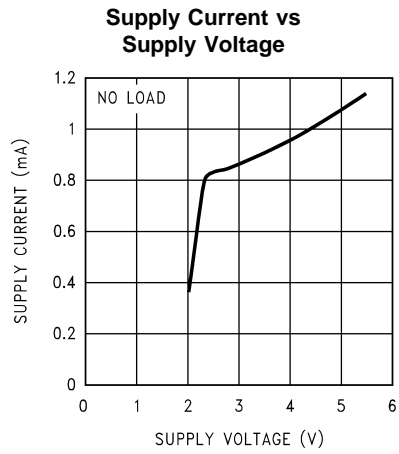

10127644

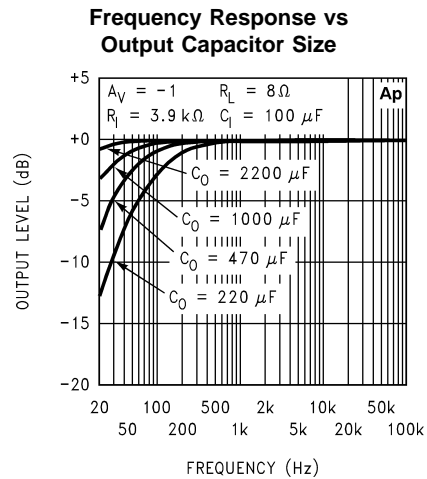

10127645

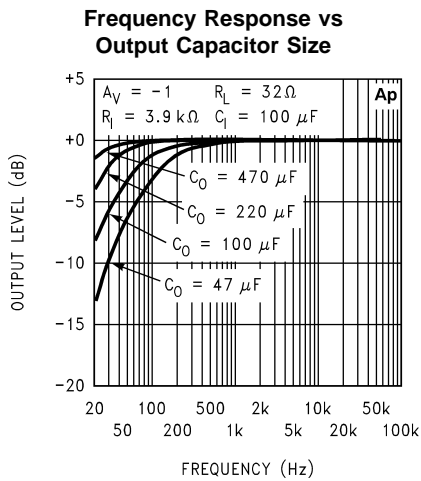

10127646

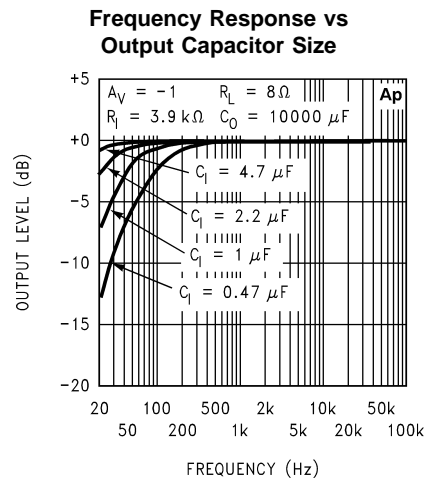

10127647

Typical Performance Characteristics (Continued)

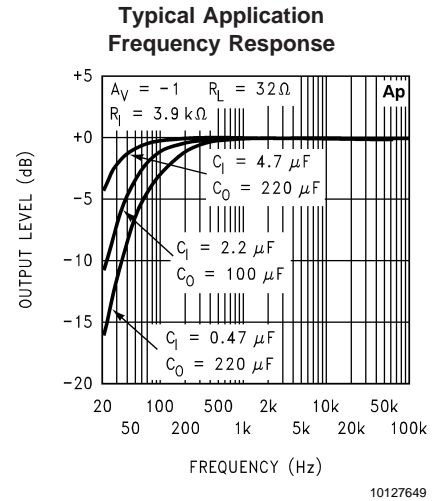
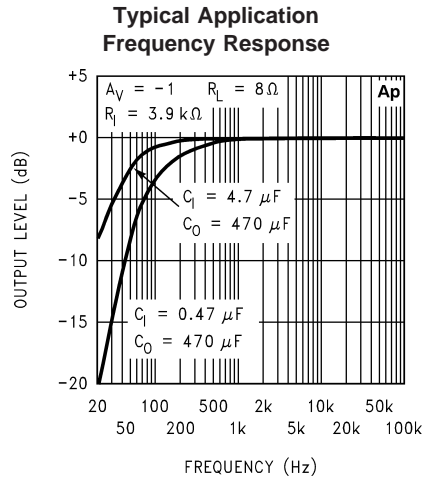

Application Information

EXPOSED-DAP PACKAGE PCB MOUNTING CONSIDERATION

The LM4808's exposed-dap (die attach paddle) package (LD) provides a low thermal resistance between the die and the PCB to which the part is mounted and soldered. This allows rapid heat transfer from the die to the surrounding PCB copper traces, ground plane, and surrounding air.

The LD package should have its DAP soldered to a copper pad on the PCB. The DAP's PCB copper pad may be connected to a large plane of continuous unbroken copper. This plane forms a thermal mass, heat sink, and radiation area.

However, since the LM4808 is designed for headphone applications, connecting a copper plane to the DAP's PCB copper pad is not required. The LM4808's Power Dissipation vs Output Power Curve in the **Typical Performance Characteristics** shows that the maximum power dissipated is just 45mW per amplifier with a 5V power supply and a 32Ω load.

Further detailed and specific information concerning PCB layout, fabrication, and mounting an LD (LLP) package is available from National Semiconductor's Package Engineering Group under application note AN1187.

POWER DISSIPATION

Power dissipation is a major concern when using any power amplifier and must be thoroughly understood to ensure a successful design. Equation 1 states the maximum power dissipation point for a single-ended amplifier operating at a given supply voltage and driving a specified output load.

$$P_{\text{DMAX}} = (V_{\text{DD}})^2 / (2\pi^2 R_L) \quad (1)$$

Since the LM4808 has two operational amplifiers in one package, the maximum internal power dissipation point is twice that of the number which results from Equation 1. Even with the large internal power dissipation, the LM4808 does not require heat sinking over a large range of ambient temperature. From Equation 1, assuming a 5V power supply and a 32Ω load, the maximum power dissipation point is 40mW per amplifier. Thus the maximum package dissipation point is 80mW. The maximum power dissipation point obtained must not be greater than the power dissipation that results from Equation 2:

$$P_{\text{DMAX}} = (T_{\text{JMAX}} - T_A) / \theta_{\text{JA}} \quad (2)$$

For package MUA08A, $\theta_{\text{JA}} = 210^\circ\text{C/W}$, $T_{\text{JMAX}} = 150^\circ\text{C}$ for the LM4808. Depending on the ambient temperature, T_A , of the system surroundings, Equation 2 can be used to find the maximum internal power dissipation supported by the IC packaging. If the result of Equation 1 is greater than that of Equation 2, then either the supply voltage must be decreased, the load impedance increased or T_A reduced. For the typical application of a 5V power supply, with a 32Ω load, the maximum ambient temperature possible without violating the maximum junction temperature is approximately 133.2°C provided that device operation is around the maximum power dissipation point. Power dissipation is a function of output power and thus, if typical operation is not around the maximum power dissipation point, the ambient temperature may be increased accordingly. Refer to the **Typical Performance Characteristics** curves for power dissipation information for lower output powers.

POWER SUPPLY BYPASSING

As with any power amplifier, proper supply bypassing is critical for low noise performance and high power supply rejection. Applications that employ a 5V regulator typically use a 10μF in parallel with a 0.1μF filter capacitors to stabilize the regulator's output, reduce noise on the supply line, and improve the supply's transient response. However, their presence does not eliminate the need for a local 0.1μF supply bypass capacitor, C_S , connected between the LM4808's supply pins and ground. Keep the length of leads and traces that connect capacitors between the LM4808's power supply pin and ground as short as possible. Connecting a 1.0μF capacitor, C_B , between the IN A(+) / IN B(+) node and ground improves the internal bias voltage's stability and improves the amplifier's PSRR. The PSRR improvements increase as the bypass pin capacitor value increases. Too large, however, increases the amplifier's turn-on time. The selection of bypass capacitor values, especially C_B , depends on desired PSRR requirements, click and pop performance (as explained in the section, **Selecting Proper External Components**), system cost, and size constraints.

SELECTING PROPER EXTERNAL COMPONENTS

Optimizing the LM4808's performance requires properly selecting external components. Though the LM4808 operates well when using external components with wide tolerances, best performance is achieved by optimizing component values.

The LM4808 is unity-gain stable, giving a designer maximum design flexibility. The gain should be set to no more than a given application requires. This allows the amplifier to achieve minimum THD+N and maximum signal-to-noise ratio. These parameters are compromised as the closed-loop gain increases. However, low gain demands input signals with greater voltage swings to achieve maximum output power. Fortunately, many signal sources such as audio CODECs have outputs of 1V_{RMS} (2.83V_{P-P}). Please refer to the **Audio Power Amplifier Design** section for more information on selecting the proper gain.

Input and Output Capacitor Value Selection

Amplifying the lowest audio frequencies requires high value input and output coupling capacitors (C_I and C_O in *Figure 1*). A high value capacitor can be expensive and may compromise space efficiency in portable designs. In many cases, however, the speakers used in portable systems, whether internal or external, have little ability to reproduce signals below 150Hz. Applications using speakers with this limited frequency response reap little improvement by using high value input and output capacitors.

Besides affecting system cost and size, C_I has an effect on the LM4808's click and pop performance. The magnitude of the pop is directly proportional to the input capacitor's size. Thus, pops can be minimized by selecting an input capacitor value that is no higher than necessary to meet the desired -3dB frequency.

As shown in *Figure 1*, the input resistor, R_I and the input capacitor, C_I , produce a -3dB high pass filter cutoff frequency that is found using Equation (3). In addition, the output load R_L , and the output capacitor C_O , produce a -3dB high pass filter cutoff frequency defined by Equation (4).

$$f_{\text{I-3db}} = 1/2\pi R_I C_I \quad (3)$$

$$f_{\text{O-3db}} = 1/2\pi R_L C_O \quad (4)$$

Application Information (Continued)

Also, careful consideration must be taken in selecting a certain type of capacitor to be used in the system. Different types of capacitors (tantalum, electrolytic, ceramic) have unique performance characteristics and may affect overall system performance.

Bypass Capacitor Value

Besides minimizing the input capacitor size, careful consideration should be paid to the value of the bypass capacitor, C_B . Since C_B determines how fast the LM4808 settles to quiescent operation, its value is critical when minimizing turn-on pops. The slower the LM4808's outputs ramp to their quiescent DC voltage (nominally $1/2 V_{DD}$), the smaller the turn-on pop. Choosing C_B equal to $1.0\mu\text{F}$ or larger, will minimize turn-on pops. As discussed above, choosing C_i no larger than necessary for the desired bandwidth helps minimize clicks and pops.

AUDIO POWER AMPLIFIER DESIGN

Design a Dual 70mW/32Ω Audio Amplifier

Given:

Power Output	70mW
Load Impedance	32Ω
Input Level	1Vrms (max)
Input Impedance	20kΩ
Bandwidth	100Hz–20kHz ± 0.50dB

The design begins by specifying the minimum supply voltage necessary to obtain the specified output power. One way to find the minimum supply voltage is to use the Output Power vs Supply Voltage curve in the **Typical Performance Characteristics** section. Another way, using Equation (5), is to calculate the peak output voltage necessary to achieve the desired output power for a given load impedance. To account for the amplifier's dropout voltage, two additional voltages, based on the Dropout Voltage vs Supply Voltage in the **Typical Performance Characteristics** curves, must be added to the result obtained by Equation (5). For a single-ended application, the result is Equation (6).

$$V_{\text{opeak}} = \sqrt{(2R_L P_O)} \quad (5)$$

$$V_{DD} \geq (2V_{\text{OPEAK}} + (V_{\text{ODTOP}} + V_{\text{ODBOT}})) \quad (6)$$

The Output Power vs Supply Voltage graph for a 32Ω load indicates a minimum supply voltage of 4.8V. This is easily met by the commonly used 5V supply voltage. The additional voltage creates the benefit of headroom, allowing the LM4808 to produce peak output power in excess of 70mW without clipping or other audible distortion. The choice of supply voltage must also not create a situation that violates maximum power dissipation as explained above in the **Power Dissipation** section. Remember that the maximum power dissipation point from Equation (1) must be multiplied by two since there are two independent amplifiers inside the

package. Once the power dissipation equations have been addressed, the required gain can be determined from Equation (7).

$$A_V \geq \sqrt{(P_O R_L)} / (V_{IN}) = V_{\text{orms}} / V_{\text{inrms}} \quad (7)$$

Thus, a minimum gain of 1.497 allows the LM4808 to reach full output swing and maintain low noise and THD+N performance. For this example, let $A_V = 1.5$.

The amplifiers overall gain is set using the input (R_i) and feedback (R_f) resistors. With the desired input impedance set at 20kΩ, the feedback resistor is found using Equation (8).

$$A_V = R_f / R_i \quad (8)$$

The value of R_f is 30kΩ.

The last step in this design is setting the amplifier's –3dB frequency bandwidth. To achieve the desired ±0.25dB pass band magnitude variation limit, the low frequency response must extend to at least one-fifth the lower bandwidth limit and the high frequency response must extend to at least five times the upper bandwidth limit. The gain variation for both response limits is 0.17dB, well within the ±0.25dB desired limit. The results are an

$$f_L = 100\text{Hz} / 5 = 20\text{Hz} \quad (9)$$

and a

$$f_H = 20\text{kHz} * 5 = 100\text{kHz} \quad (10)$$

As stated in the **External Components** section, both R_i in conjunction with C_i , and C_o with R_L , create first order high-pass filters. Thus to obtain the desired low frequency response of 100Hz within ±0.5dB, both poles must be taken into consideration. The combination of two single order filters at the same frequency forms a second order response. This results in a signal which is down 0.34dB at five times away from the single order filter –3dB point. Thus, a frequency of 20Hz is used in the following equations to ensure that the response is better than 0.5dB down at 100Hz.

$$C_i \geq 1 / (2\pi * 20 \text{ k}\Omega * 20 \text{ Hz}) = 0.397\mu\text{F}; \text{ use } 0.39\mu\text{F}.$$

$$C_o \geq 1 / (2\pi * 32\Omega * 20 \text{ Hz}) = 249\mu\text{F}; \text{ use } 330\mu\text{F}.$$

The high frequency pole is determined by the product of the desired high frequency pole, f_H , and the closed-loop gain, A_V . With a closed-loop gain of 1.5 and $f_H = 100\text{kHz}$, the resulting GBWP = 150kHz which is much smaller than the LM4808's GBWP of 900kHz. This figure displays that if a designer has a need to design an amplifier with a higher gain, the LM4808 can still be used without running into bandwidth limitations.

Demonstration Board Layout

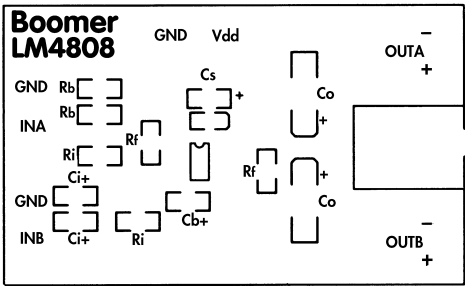

10127639

**Recommended SO PC Board Layout:
Top Silkscreen**

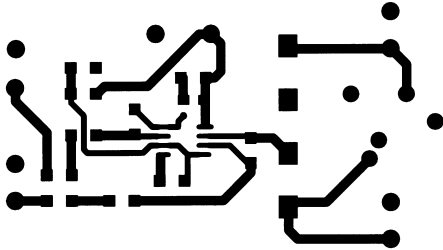

10127640

**Recommended SOP PC Board Layout:
Top Layer**

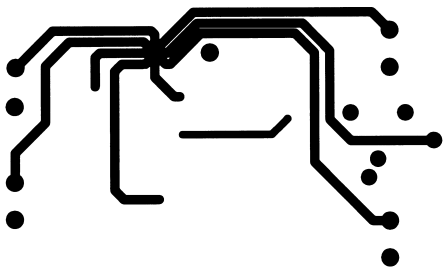

10127642

**Recommended SOP PC Board Layout:
Bottom Layer**

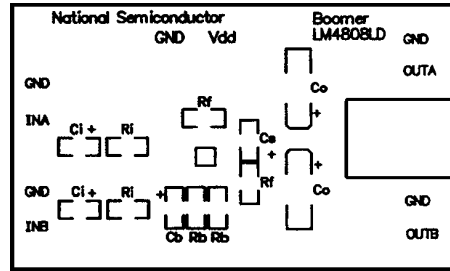

10127660

**Recommended LD PC Board Layout:
Top Silkscreen**

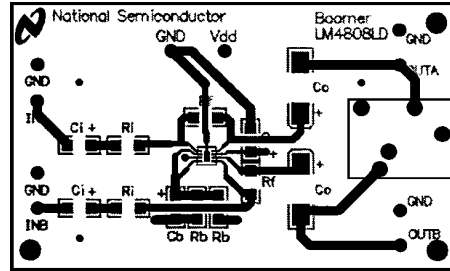

10127661

**Recommended LD PC Board Layout:
Top Layer**

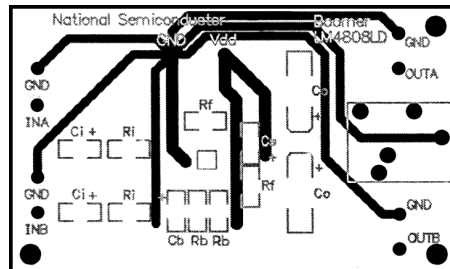

10127662

**Recommended LD PC Board Layout:
Bottom Layer**

Physical Dimensions inches (millimeters)
unless otherwise noted

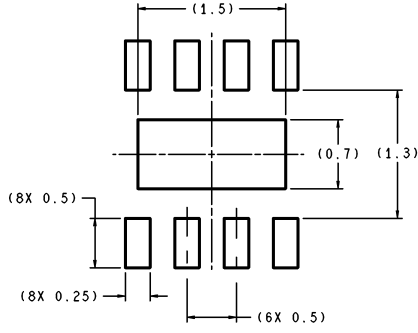

DIMENSIONS ARE IN MILLIMETERS

RECOMMENDED LAND PATTERN
1:1 RATIO WITH PKG SOLDER PADS

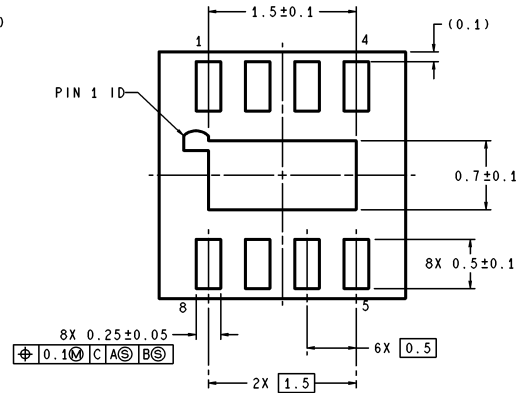
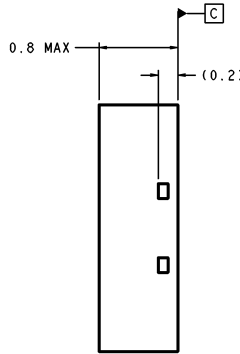
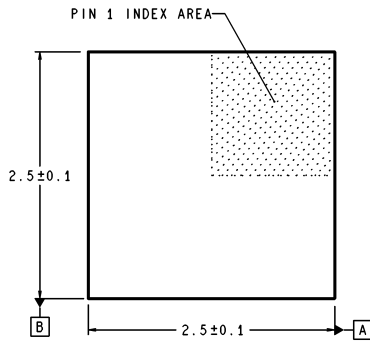

LDA08B (Rev A)

Order Number LM4808LD
NS Package Number LDA08B

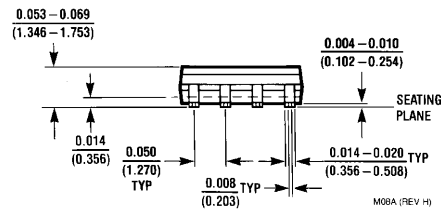
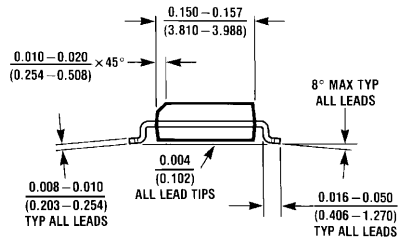
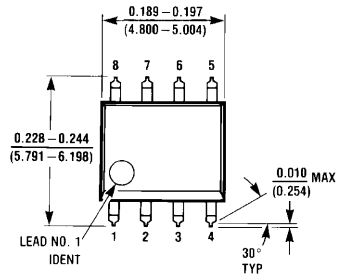

Order Number LM4808M
NS Package Number M08A

Physical Dimensions inches (millimeters) unless otherwise noted (Continued)

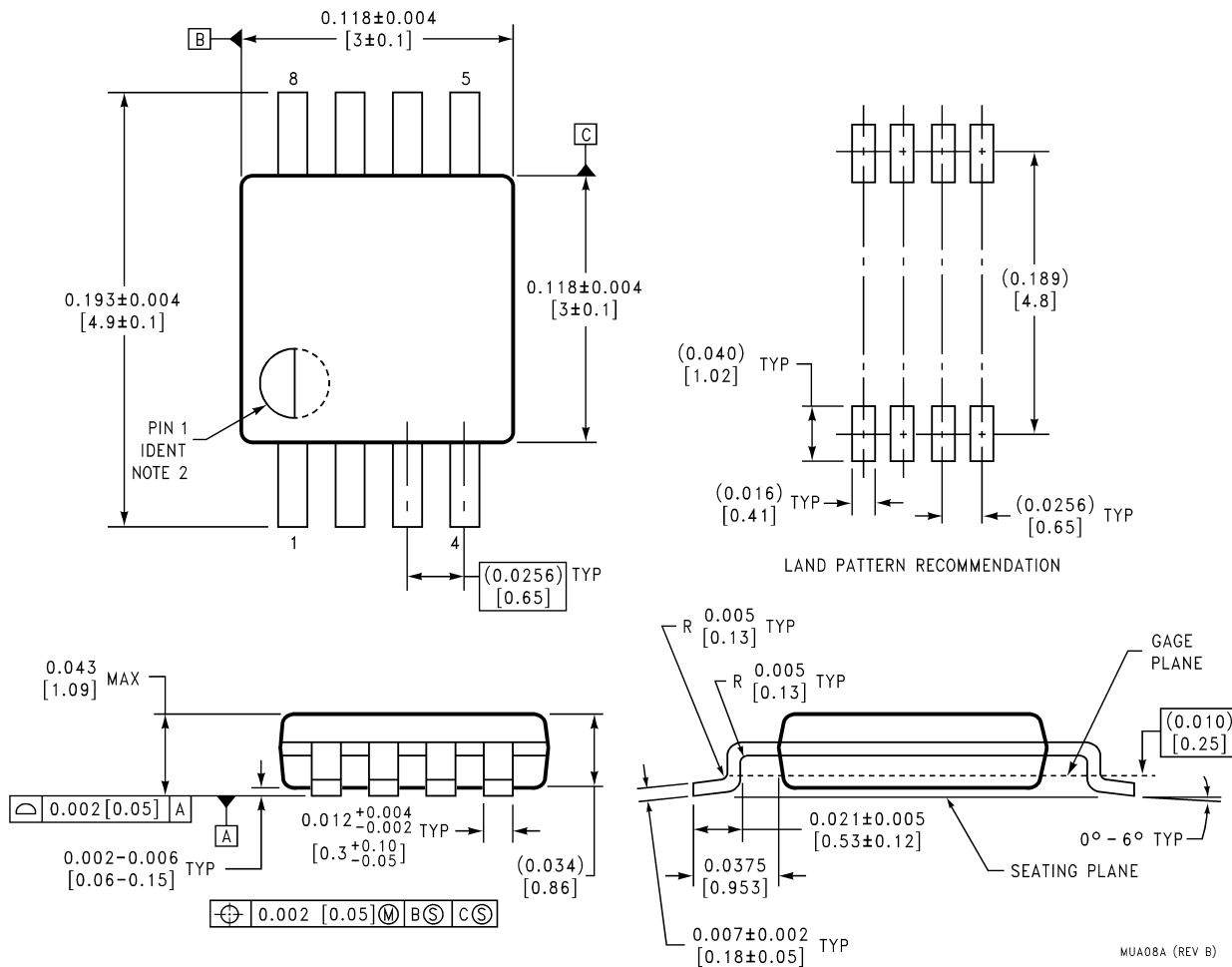

Order Number LM4808MM
NS Package Number MUA08A

LIFE SUPPORT POLICY

NATIONAL'S PRODUCTS ARE NOT AUTHORIZED FOR USE AS CRITICAL COMPONENTS IN LIFE SUPPORT DEVICES OR SYSTEMS WITHOUT THE EXPRESS WRITTEN APPROVAL OF THE PRESIDENT AND GENERAL COUNSEL OF NATIONAL SEMICONDUCTOR CORPORATION. As used herein:

1. Life support devices or systems are devices or systems which, (a) are intended for surgical implant into the body, or (b) support or sustain life, and whose failure to perform when properly used in accordance with instructions for use provided in the labeling, can be reasonably expected to result in a significant injury to the user.
2. A critical component is any component of a life support device or system whose failure to perform can be reasonably expected to cause the failure of the life support device or system, or to affect its safety or effectiveness.

National Semiconductor Corporation
 Americas
 Email: support@nsc.com

National Semiconductor Europe
 Fax: +49 (0) 180-530 85 86
 Email: europe.support@nsc.com
 Deutsch Tel: +49 (0) 69 9508 6208
 English Tel: +44 (0) 870 24 0 2171
 Français Tel: +33 (0) 1 41 91 8790

National Semiconductor Asia Pacific Customer Response Group
 Tel: 65-2544466
 Fax: 65-2504466
 Email: ap.support@nsc.com

National Semiconductor Japan Ltd.
 Tel: 81-3-5639-7560
 Fax: 81-3-5639-7507

www.national.com