

# LM4869 Boomer® Audio Power Amplifier Series

## 1.9W Differential Input, BTL Output Stereo Audio Amplifier with Selectable Gain and Shutdown

### General Description

The LM4869 features differential stereo inputs, BTL (bridge-tied load) outputs, and four externally selectable fixed gains. Operating on a single 5V supply, the LM4869 delivers 1.2W and 1.9W (typ) of output power to an 8Ω and 4Ω BTL load (Note 1), respectively, with less than 1% THD+N. The LM4869's gain is selected using two digital inputs. The nominal gain values are 6dB, 10dB, 15.6dB, and 21.6dB.

The LM4869 is designed for notebook and other handheld portable applications. It delivers high quality output power from a surface-mount package and requires few external components.

Other features include an active-low micropower shutdown mode input and thermal shutdown protection.

### Key Specifications

- BTL output Power  
 $R_L = 4\Omega$ ,  $V_{DD} = 5.0V$ , and THD+N = 1%      1.9W (typ)
- BTL output Power  
 $R_L = 8\Omega$ ,  $V_{DD} = 5.0V$ , and THD+N = 1%      1.2W (typ)

- Micropower shutdown current      0.1μA (typ)
- PSRR (@ 1kHz,  $V_{DD} = 5V$ , (Fig.1))      62dB (typ)

### Features

- Fully differential input and output
- Internal gain set: 6dB, 10dB, 15.6dB, and 21.6dB
- Improved 'click and pop' suppression
- Thermal shutdown protection circuit
- Ultra low current micropower shutdown mode
- 2.0V to 5.5V operation
- Available in space-saving exposed-DAP TSSOP package

### Applications

- Notebook computers
- PDAs
- Portable electronic devices

### Connection Diagram

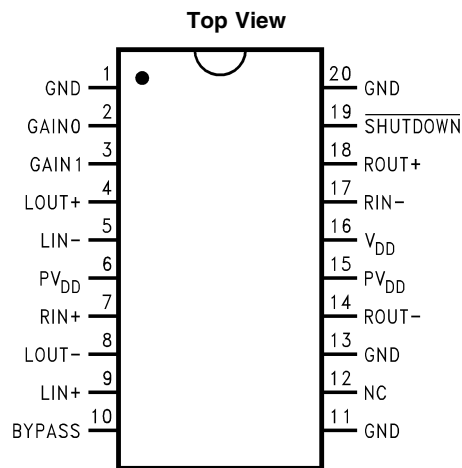

20042802

**Order Number LM4869MH**  
 See NS Package Number MXA20A for Exposed-DAP TSSOP

## Typical Application

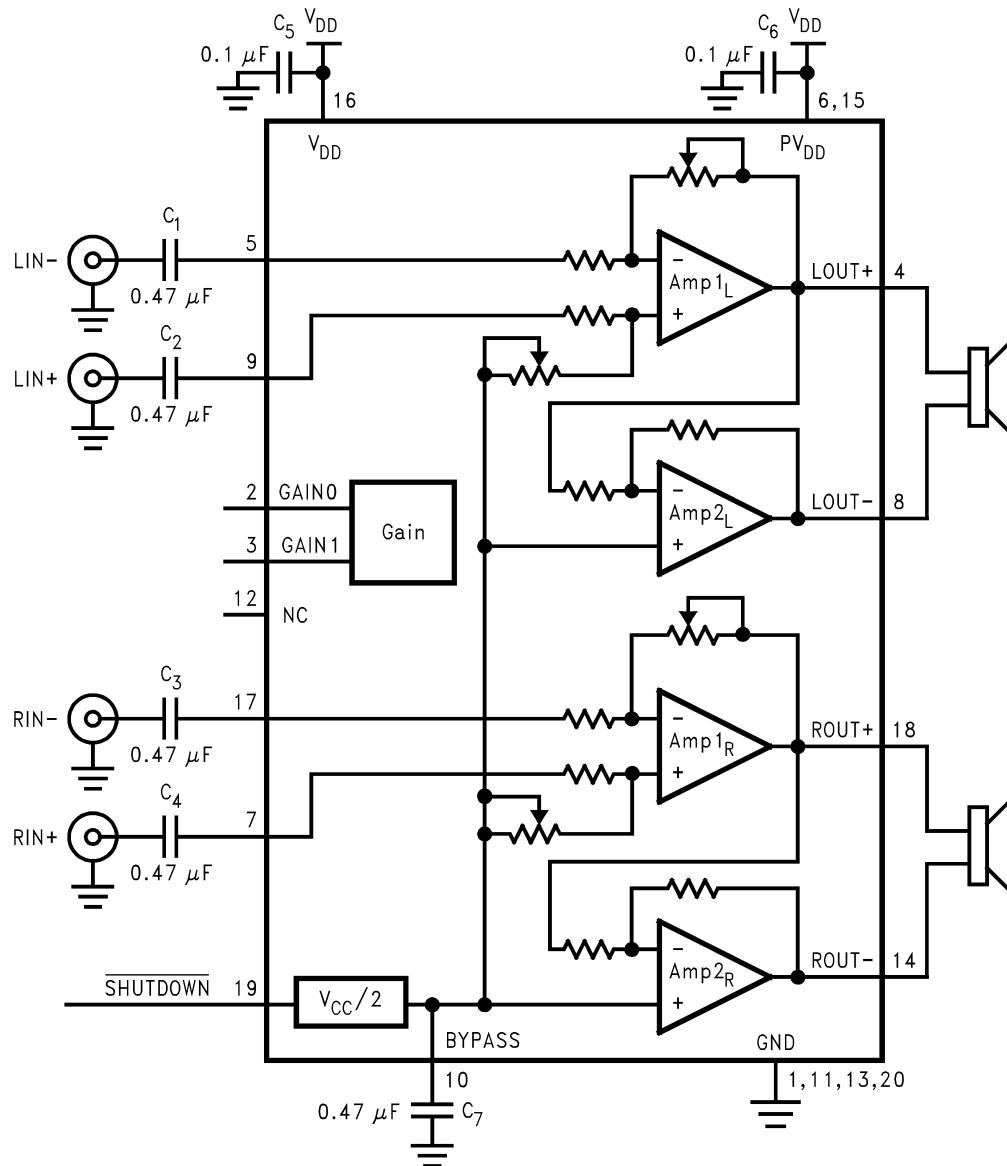

20042801

FIGURE 1. Typical Audio Amplifier Application Circuit

**Absolute Maximum Ratings** (Notes 2, 3)

If Military/Aerospace specified devices are required, please contact the National Semiconductor Sales Office/Distributors for availability and specifications.

Supply Voltage	6.0V
Storage Temperature	-65°C to + 150°C
Input Voltage	-0.3V to $V_{DD} + 0.3V$
Power Dissipation (Note 4)	Internally Limited
ESD Susceptibility (Note 5)	2000V
ESD Susceptibility (Note 6)	200V
Junction Temperature	150°C
Soldering Information	
Small Outline Package	
Vapor Phase (60 sec.)	215°C

Infrared (15 sec.)

220°C

See AN-450 "Surface Mounting and their Effects on Product Reliability" for other methods of soldering surface mount devices.

Thermal Resistance

$\theta_{JC}$ (typ) MXA20A	2°C/W
$\theta_{JA}$ (typ) MXA20A	47°C/W (Note 7)
$\theta_{JA}$ (typ) MXA20A	27°C/W (Note 8)

**Operating Ratings**

Temperature Range

$$T_{MIN} \leq T_A \leq T_{MAX}$$

-40°C ≤ TA ≤ 85°C

Supply Voltage

2.0 V ≤ V<sub>DD</sub> ≤ 5.5V**Electrical Characteristics for LM4869** (Notes 2, 9)

The following specifications applies to the LM4869 when used in the circuit shown in Figure 1 and operating with V<sub>DD</sub> = 5V and A<sub>v</sub> = 6dB, unless otherwise specified. Limits apply for T<sub>A</sub> = 25°C.

Symbol	Parameter	Conditions	LM4869		Units (Limits)
			Typical (Note 9)	Limit (Note 10) (Note 11)	
V <sub>DD</sub>	Supply Voltage			2 5.5	V (min) V (max)
I <sub>DD</sub>	Quiescent Power Supply Current	V <sub>IN</sub> = 0V, I <sub>O</sub> = 0A, R <sub>L</sub> = ∞	9.0	12.0	mA (max)
I <sub>SD</sub>	Shutdown Current	V <sub>shutdown</sub> = GND	0.1	1.0	μA (max)
V <sub>OS</sub>	Output Offset Voltage		7	50	mV (max)
PSRR	Output Supply Rejection Ratio	V <sub>DD</sub> = 5V, V <sub>RIPPLE</sub> = 200mV <sub>P-P</sub> sinewave, C <sub>BYPASS</sub> = 0.47μF, R <sub>L</sub> = 8Ω	62		dB
P <sub>O</sub>	Output Power (Note 12)	THD+N = 1% (max), f = 1kHz (Note13) R <sub>L</sub> = 4Ω R <sub>L</sub> = 8Ω	1.9 1.2	1.0	W W (min)
		THD+N = 10% (max), f = 1kHz (Note13) R <sub>L</sub> = 4Ω R <sub>L</sub> = 8Ω	2.6 1.5		W W
THD+N	Total Harmonic Distortion + Noise	20Hz ≤ f ≤ 20kHz R <sub>L</sub> = 4Ω, P <sub>O</sub> = 2W R <sub>L</sub> = 8Ω, P <sub>O</sub> = 1W	0.3 0.3		% %
S/N	Signal-to-Noise Ratio	f = 1kHz, C <sub>BYPASS</sub> = 0.47μF, P <sub>O</sub> = 1.1W, R <sub>L</sub> = 8Ω	97		dB
R <sub>IN</sub>	Input Resistance	Pins 5, 7, 9, and 17	25	20	kΩ (min)
ΔA <sub>v</sub>	Gain Accuracy	R <sub>L</sub> = 8Ω			
		Logic Low Applied to Pin 2 Logic Low Applied to Pin 3	6	5.70 6.30	dB (min) dB (max)
		Logic Low Applied to Pin 2 Logic High Applied to Pin 3	10	9.65 10.35	dB (min) dB (max)
		Logic High Applied to Pin 2 Logic Low Applied to Pin 3	15.6	15.25 15.95	dB (min) dB (max)
		Logic High Applied to Pin 2 Logic High Applied to Pin 3	21.6	21.25 21.95	dB (min) dB (max)

## Electrical Characteristics for LM4869 (Notes 2, 9) (Continued)

The following specifications applies to the LM4869 when used in the circuit shown in Figure 1 and operating with  $V_{DD} = 5V$  and  $A_V = 6dB$ , unless otherwise specified. Limits apply for  $T_A = 25^\circ C$ .

Symbol	Parameter	Conditions	LM4869		Units (Limits)
			Typical (Note 9)	Limit (Note 10) (Note 11)	
$\Delta A_{V\ CH-CH}$	Channel-to-Channel Gain Mismatch	$R_L = 8\Omega$			
		Logic Low Applied to Pin 2 Logic Low Applied to Pin 3	0.12	0.3	dB (max)
		Logic Low Applied to Pin 2 Logic High Applied to Pin 3	0.12	0.3	dB (max)
		Logic High Applied to Pin 2 Logic Low Applied to Pin 3	0.12	0.3	dB (max)
		Logic High Applied to Pin 2 Logic High Applied to Pin 3	0.12	0.3	dB (max)

**Note 1:** An LM4869MH that has been properly mounted to a circuit board with a copper heatsink area of at least  $2in^2$  will deliver 1.9W into  $4\Omega$ .

**Note 2:** All voltages are measured with respect to the GND pin unless other wise specified.

**Note 3:** Absolute Maximum Ratings indicate limits beyond which damage to the device may occur. Operating Ratings indicate conditions for which the device is functional but do not guarantee specific performance limits. Electrical Characteristics state DC and AC electrical specifications under particular test conditions that guarantee specific performance limits. This assumes that the device is within the Operating Ratings. Specifications are not guaranteed for parameters where no limit is given, however, the typical value is a good indication of device performance.

**Note 4:** The maximum power dissipation must be derated at elevated temperatures and is dictated by  $T_{JMAX}$ ,  $\theta_{JA}$ , and the ambient temperature,  $T_A$ . The maximum allowable power dissipation is  $P_{DMAX} = (T_{JMAX} - T_A)/\theta_{JA}$  or the number given in Absolute Maximum Ratings, whichever is lower. For the LM4869, see power derating currents for more information.

**Note 5:** Human body model, 100 pF discharged through a 1.5 k $\Omega$  resistor.

**Note 6:** Machine Model, 220pF-240pF discharged through all pins.

**Note 7:** The given  $\theta_{JA}$  is for an LM4869 packaged in an MXA20A with the exposed-DAP soldered to an exposed  $4in^2$  area of 1oz printed circuit board copper. When driving  $4\Omega$  loads from a 5V supply, the LM4869MH must be mounted to the circuit board and its exposed-DAP soldered to an exposed  $2in^2$  area of 1oz PCB copper.

**Note 8:** The given  $\theta_{JA}$  is for an LM4869 packaged in an MXA20A with the exposed DAP soldered to an exposed  $8in^2$  area of 1oz printed circuit board (PCB) copper and two  $8in^2$  inner layer ground planes in a four-layer PCB.

**Note 9:** Typicals are measured at  $25^\circ C$  and represent the parametric norm.

**Note 10:** Limits are guaranteed to National's AOQL (Average Outgoing Quality Level).

**Note 11:** Datasheet minimum and maximum specification limits are guaranteed by design, test, or statistical analysis.

**Note 12:** Output power is measured at the amplifier's package pins.

**Note 13:** When driving  $4\Omega$  loads and operating on a 5V supply, the LM4869MH must be mounted to a circuit board that has a minimum of  $2.5in^2$  of exposed, uninterrupted copper area connected to the LLP package's exposed DAP.

## External Components Description

( Refer to Figure 1.)

Components		Functional Description
1.	$C_i$	The input coupling capacitor blocks DC voltage at the amplifier's inverting input terminals. $C_i$ , along with the LM4869's fixed input resistance $R_i$ (25k $\Omega$ , typ), creates a highpass filter with $f_c = 1/(2\pi R_i C_i)$ . Both inverting and noninverting inputs require a $C_i$ . Refer to the Application Information section, <b>SELECTING EXTERNAL COMPONENTS</b> , for an explanation of determining the value of $C_i$ .
2.	$C_S$	The supply bypass capacitor. Refer to the <b>POWER SUPPLY BYPASSING</b> section for information about properly placing, and selecting the value of, this capacitor.
3.	$C_B$	The capacitor, $C_B$ , filters the half-supply voltage present on the BYPASS pin. Refer to the Application Information section, <b>SELECTING EXTERNAL COMPONENTS</b> , for information concerning proper placement and selecting $C_B$ 's value.

# Typical Performance Characteristics

## MH Specific Characteristics

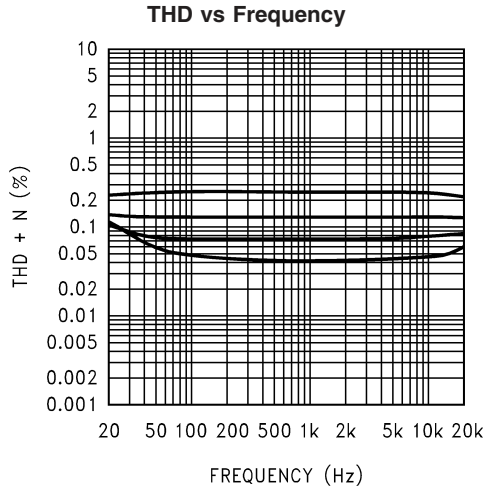

20042898  
 $V_{DD} = 5V, R_L = 4\Omega, P_{OUT} = 1000mW,$   
 at (from top to bottom at 1kHz):  
 $A_V = 21.6dB, A_V = 15.6dB,$   
 $A_V = 10dB, A_V = 6dB$

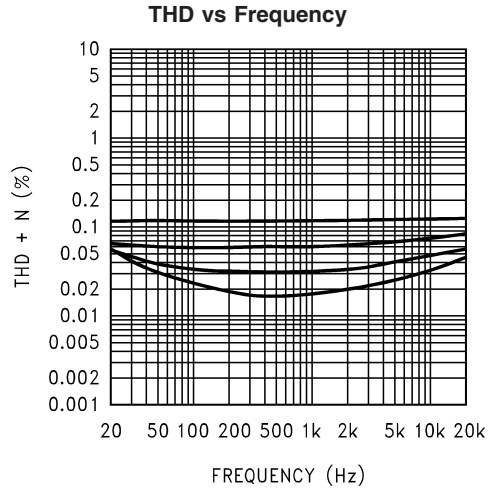

20042897  
 $V_{DD} = 5V, R_L = 8\Omega, P_{OUT} = 400mW,$   
 at (from top to bottom at 1kHz):  
 $A_V = 21.6dB, A_V = 15.6dB,$   
 $A_V = 10dB, A_V = 6dB$

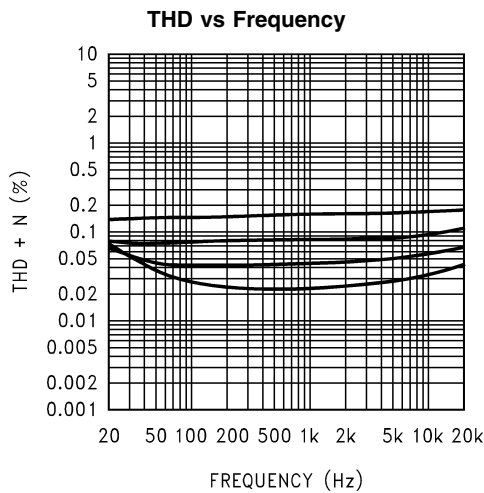

20042899  
 $V_{DD} = 5V, R_L = 8\Omega, P_{OUT} = 400mW,$   
 at (from top to bottom at 1kHz):  
 $A_V = 21.6dB, A_V = 15.6dB,$   
 $A_V = 10dB, A_V = 6dB$

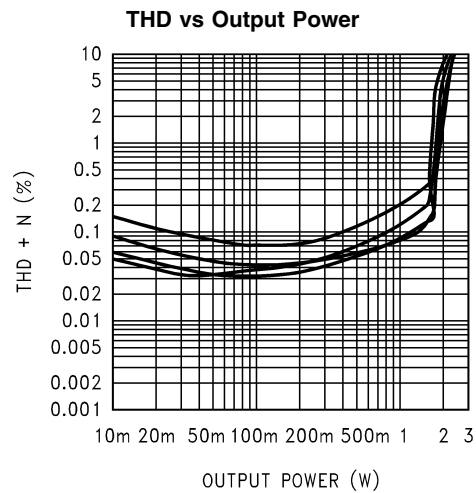

200428A0  
 $V_{DD} = 5V, R_L = 4\Omega, f_{IN} = 20Hz,$   
 at (from top to bottom at 100mW):  
 $A_V = 21.6dB, A_V = 15.6dB,$   
 $A_V = 6dB, A_V = 10dB$

# Typical Performance Characteristics

## MH Specific Characteristics (Continued)

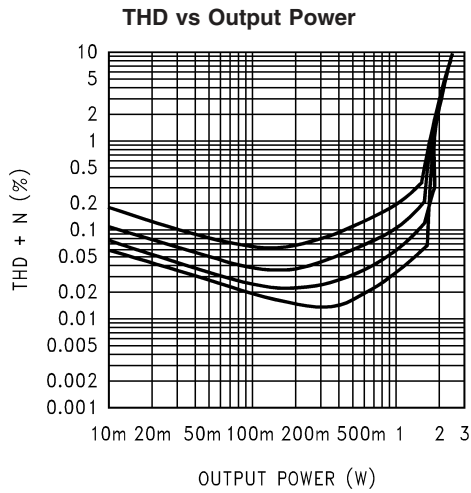

200428A1

$V_{DD} = 5V$ ,  $R_L = 4\Omega$ ,  $f_{IN} = 1kHz$ ,  
 at (from top to bottom at 200mW):  
 $A_V = 21.6dB$ ,  $A_V = 15.6dB$ ,  
 $A_V = 10dB$ ,  $A_V = 6dB$

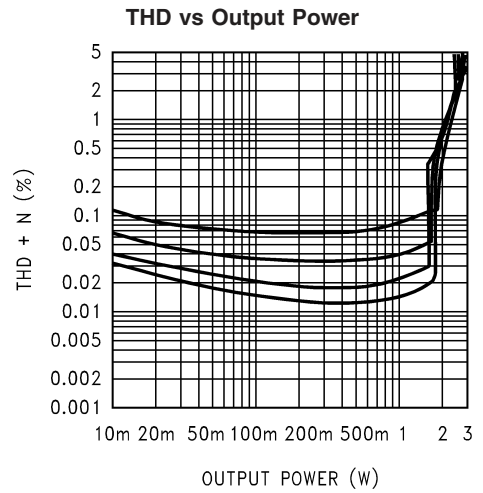

200428A2

$V_{DD} = 5V$ ,  $R_L = 4\Omega$ ,  $f_{IN} = 20kHz$ ,  
 at (from top to bottom at 200mW):  
 $A_V = 21.6dB$ ,  $A_V = 15.6dB$ ,  
 $A_V = 10dB$ ,  $A_V = 6dB$

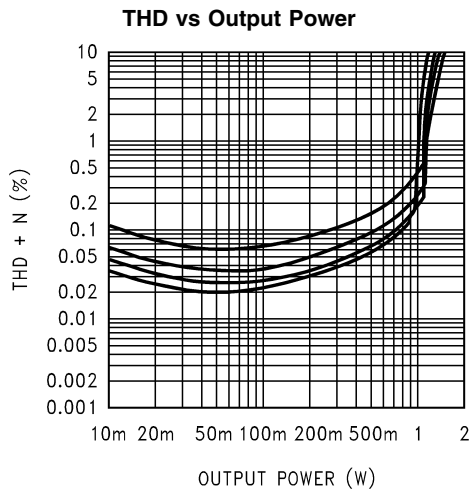

200428A3

$V_{DD} = 5V$ ,  $R_L = 8\Omega$ ,  $f_{IN} = 20Hz$ ,  
 at (from top to bottom at 200mW):  
 $A_V = 21.6dB$ ,  $A_V = 15.6dB$ ,  
 $A_V = 10dB$ ,  $A_V = 6dB$

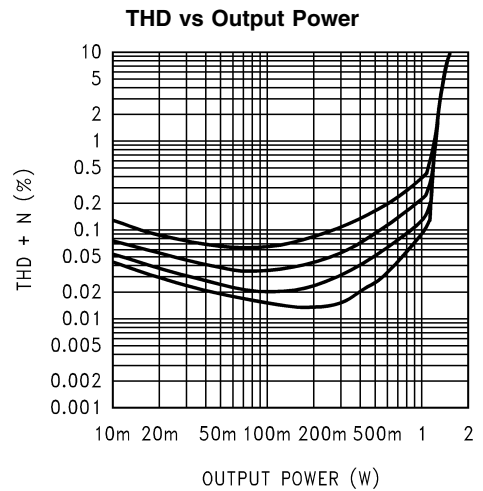

200428A4

$V_{DD} = 5V$ ,  $R_L = 8\Omega$ ,  $f_{IN} = 1kHz$ ,  
 at (from top to bottom at 200mW):  
 $A_V = 21.6dB$ ,  $A_V = 15.6dB$ ,  
 $A_V = 10dB$ ,  $A_V = 6dB$

# Typical Performance Characteristics

## MH Specific Characteristics (Continued)

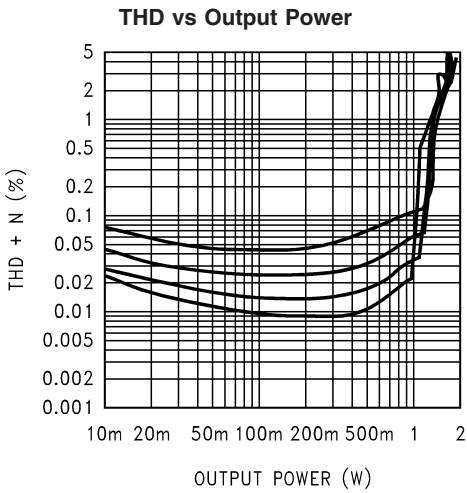

200428A5  
 $V_{DD} = 5V, R_L = 8\Omega, f_{IN} = 20kHz,$   
 at (from top to bottom at 200mW):  
 $A_V = 21.6dB, A_V = 15.6dB,$   
 $A_V = 10dB, A_V = 6dB$

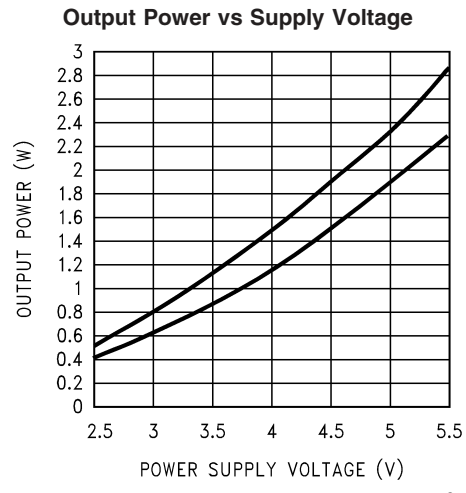

200428C3  
 $R_L = 4\Omega, f_{IN} = 1kHz,$   
 at (from top to bottom at 4V):  
 $THD+N = 10\%, THD+N = 1\%$

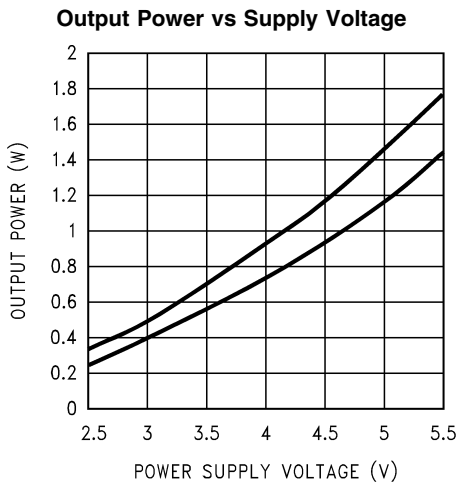

200428C4  
 $R_L = 8\Omega, f_{IN} = 1kHz,$   
 at (from top to bottom at 4V):  
 $THD+N = 10\%, THD+N = 1\%$

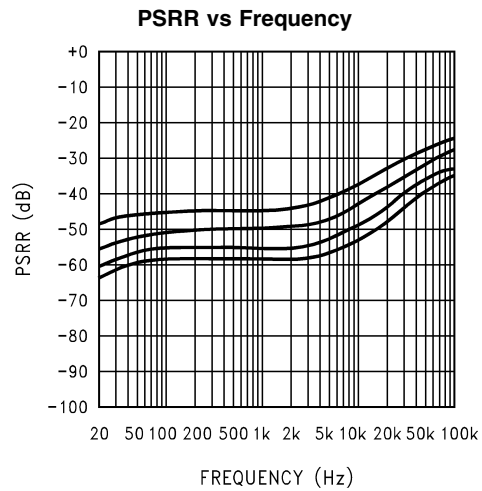

200428A8  
 $V_{DD} = 5V, R_L = 4\Omega, R_{SOURCE} = 10\Omega$   
 $V_{RIPPLE} = 200mV_{P-P},$  at (from top to bottom at 1kHz):  
 $A_V = 21.6dB, A_V = 15.6dB,$   
 $A_V = 10dB, A_V = 6dB$

# Typical Performance Characteristics

## MH Specific Characteristics (Continued)

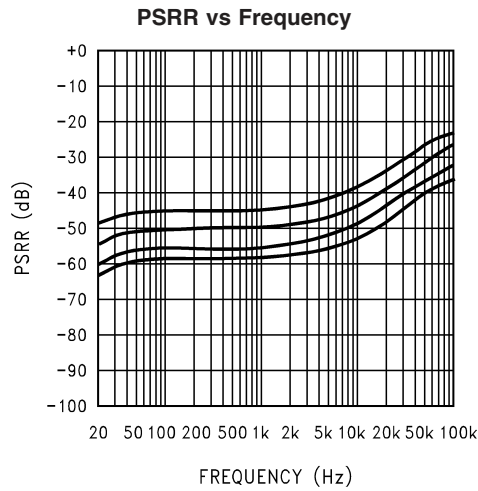

$V_{DD} = 5V, R_L = 8\Omega, R_{SOURCE} = 10\Omega$   
 $V_{RIPPLE} = 200mV_{P-P}$ , at (from top to bottom at 1kHz):  
 $A_V = 21.6dB, A_V = 15.6dB,$   
 $A_V = 10dB, A_V = 6dB$

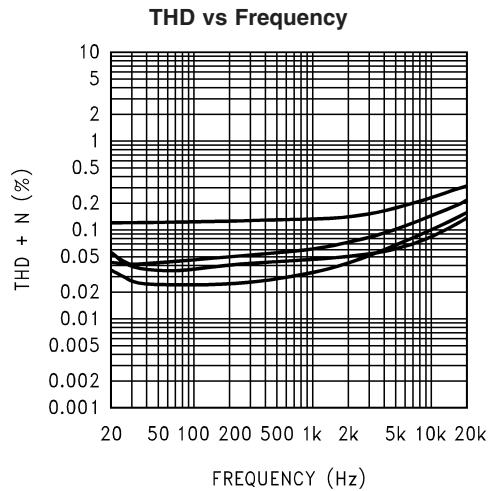

$V_{DD} = 3V, R_L = 4\Omega, P_{OUT} = 150mW,$   
 at (from top to bottom at 1kHz):  
 $A_V = 21.6dB, A_V = 15.6dB,$   
 $A_V = 10dB, A_V = 6dB$

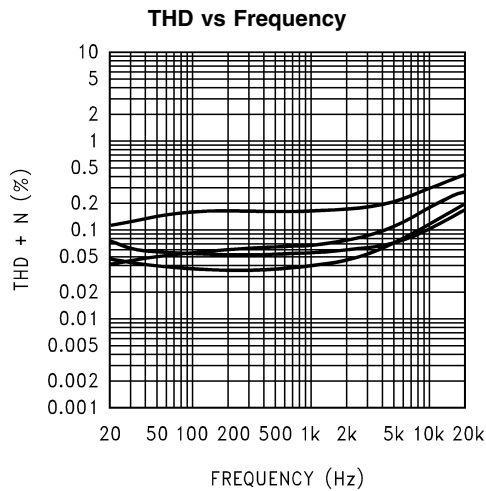

$V_{DD} = 3V, R_L = 8\Omega, P_{OUT} = 150mW,$   
 at (from top to bottom at 1kHz):  
 $A_V = 21.6dB, A_V = 15.6dB,$   
 $A_V = 10dB, A_V = 6dB$

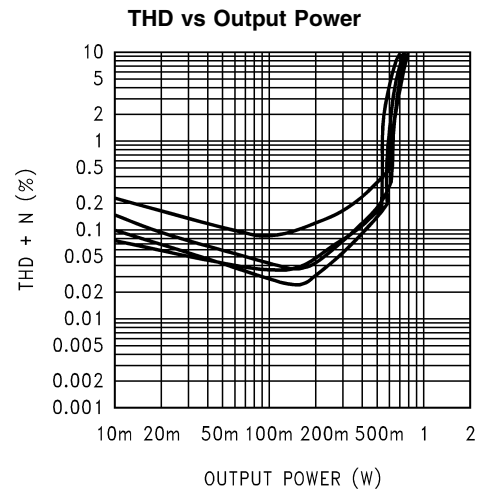

$V_{DD} = 3V, R_L = 4\Omega, f_{IN} = 1kHz,$   
 at (from top to bottom at 200mW):  
 $A_V = 21.6dB, A_V = 6dB,$   
 $A_V = 15.6dB, A_V = 10dB$



# Typical Performance Characteristics

## MH Specific Characteristics (Continued)

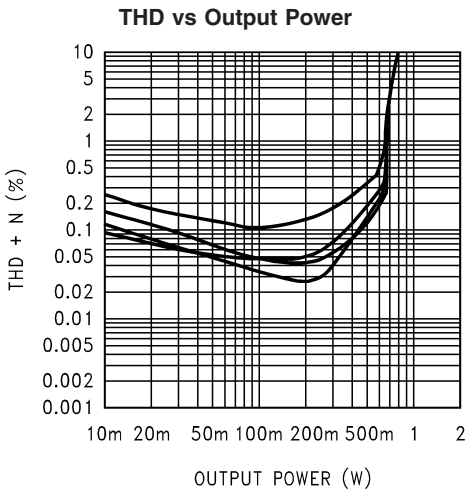

200428B2  
 $V_{DD} = 3V, R_L = 4\Omega, f_{IN} = 20Hz,$   
 at (from top to bottom at 100mW):  
 $A_V = 21.6dB, A_V = 15.6dB,$   
 $A_V = 6dB, A_V = 10dB$

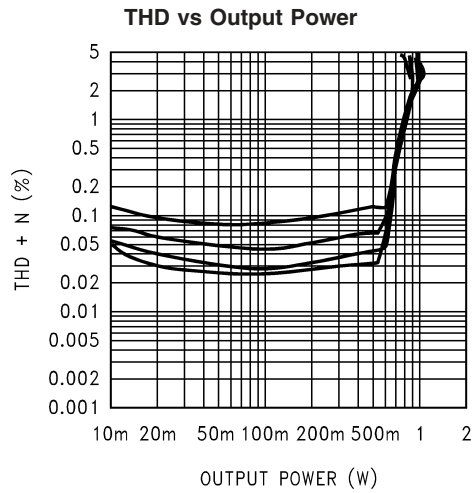

200428B4  
 $V_{DD} = 3V, R_L = 4\Omega, f_{IN} = 20kHz,$   
 at (from top to bottom at 200mW):  
 $A_V = 21.6dB, A_V = 15.6dB,$   
 $A_V = 10dB, A_V = 6dB$

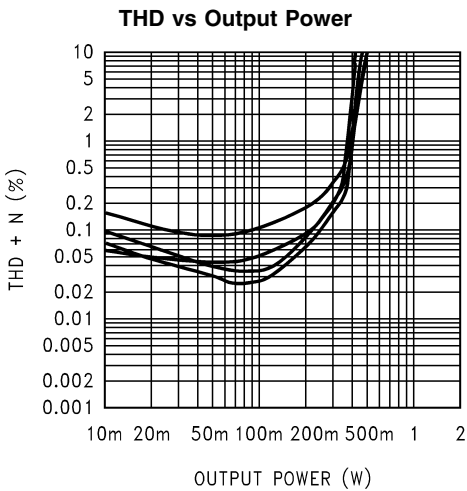

200428B5  
 $V_{DD} = 3V, R_L = 8\Omega, f_{IN} = 20Hz,$   
 at (from top to bottom at 100mW):  
 $A_V = 21.6dB, A_V = 6dB,$   
 $A_V = 15.6dB, A_V = 10dB$

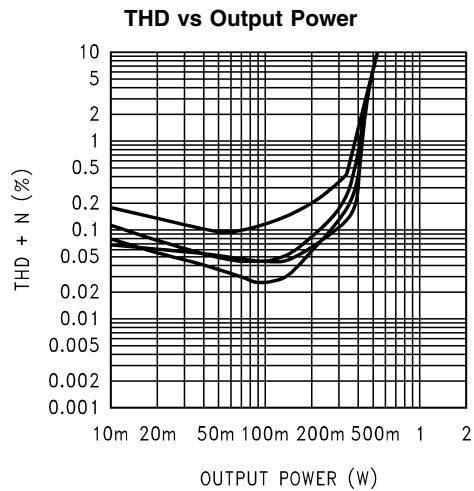

200428B6  
 $V_{DD} = 3V, R_L = 8\Omega, f_{IN} = 1kHz,$   
 at (from top to bottom at 200mW):  
 $A_V = 21.6dB, A_V = 15.6dB,$   
 $A_V = 6dB, A_V = 10dB$

# Typical Performance Characteristics MH Specific Characteristics (Continued)

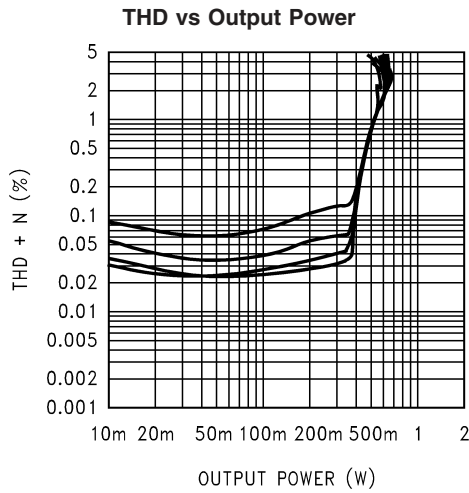

200428B7

$V_{DD} = 3V, R_L = 8\Omega, f_{IN} = 20kHz,$   
 at (from top to bottom at 200mW):  
 $A_V = 21.6dB, A_V = 15.6dB,$   
 $A_V = 10dB, A_V = 6dB$

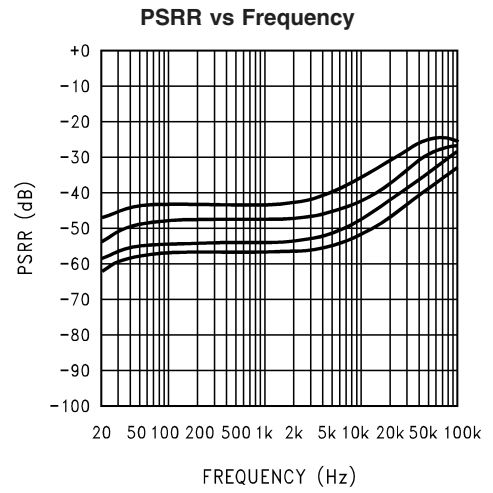

200428B8

$V_{DD} = 3V, R_L = 4\Omega, R_{SOURCE} = 10\Omega,$   
 $V_{RIPPLE} = 200mV_{P-P},$  at (from top to bottom at 1kHz):  
 $A_V = 21.6dB, A_V = 15.6dB,$   
 $A_V = 10dB, A_V = 6dB$

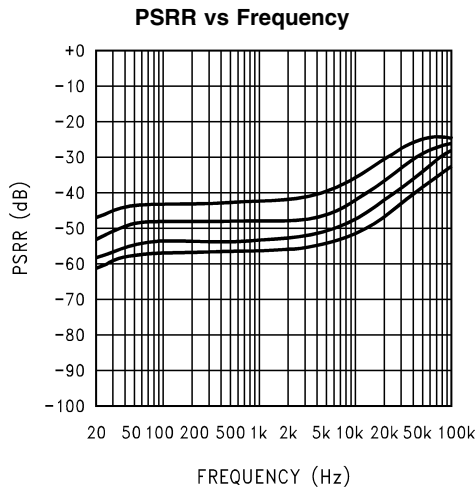

200428B9

$V_{DD} = 3V, R_L = 8\Omega, R_{SOURCE} = 10\Omega,$   
 $V_{RIPPLE} = 200mV_{P-P},$  at (from top to bottom at 1kHz):  
 $A_V = 21.6dB, A_V = 15.6dB,$   
 $A_V = 10dB, A_V = 6dB$

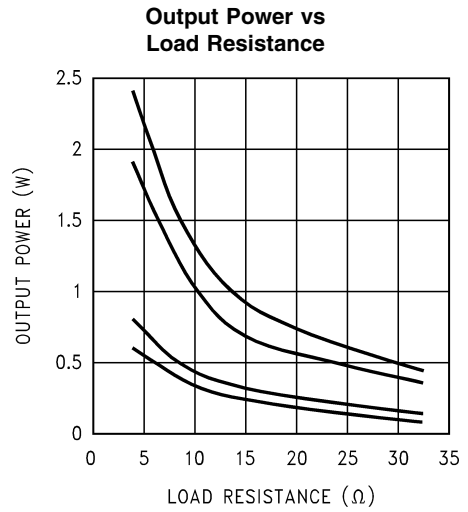

200428C0

$f_{IN} = 1kHz,$  at (from top to bottom at  $20\Omega$ ):  
 $V_{DD} = 5V, THD = 10%; V_{DD} = 5V, THD = 1%;$   
 $V_{DD} = 3V, THD = 10%; V_{DD} = 3V, THD = 1%$

## Typical Performance Characteristics

### MH Specific Characteristics (Continued)

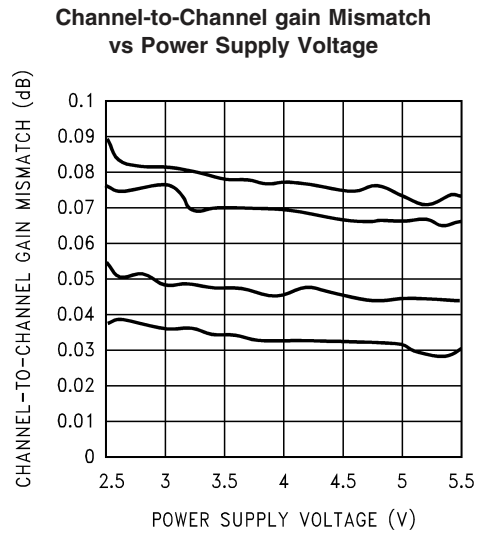

$R_L = 4\Omega$ ,  $f_{IN} = 1\text{kHz}$ ,  
 at (from top to bottom at 4V):  
 $A_V = 21.6\text{dB}$ ,  $A_V = 15.6\text{dB}$ ,  
 $A_V = 10\text{dB}$ ,  $A_V = 6\text{dB}$

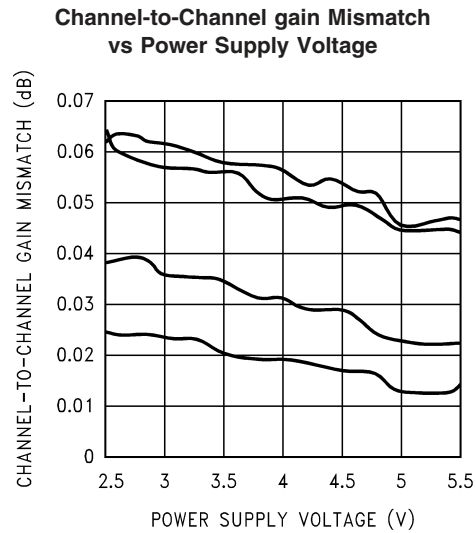

$R_L = 8\Omega$ ,  $f_{IN} = 1\text{kHz}$ ,  
 at (from top to bottom at 4V):  
 $A_V = 21.6\text{dB}$ ,  $A_V = 15.6\text{dB}$ ,  
 $A_V = 10\text{dB}$ ,  $A_V = 6\text{dB}$

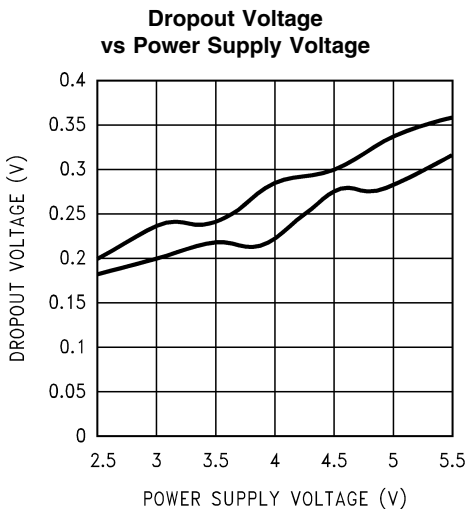

$R_L = 8\Omega$ ,  $f_{IN} = 1\text{kHz}$ , both channels driven and loaded  
 at (from top to bottom at 4V):  
 positive signal swing, negative signal swing

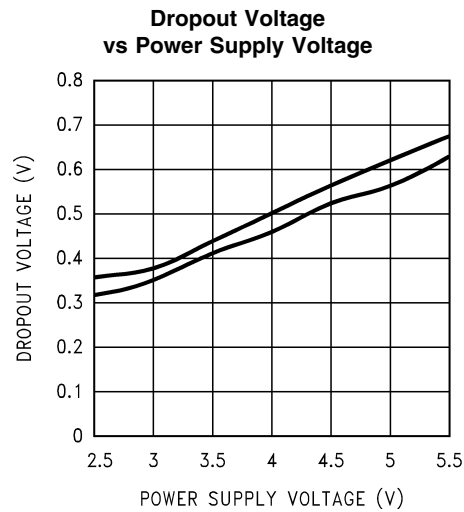

$R_L = 4\Omega$ ,  $f_{IN} = 1\text{kHz}$ , both channels driven and loaded  
 at (from top to bottom at 4V):  
 positive signal swing, negative signal swing

# Typical Performance Characteristics MH Specific Characteristics (Continued)

**Amplifier Power Dissipation vs Amplifier Load Dissipation**

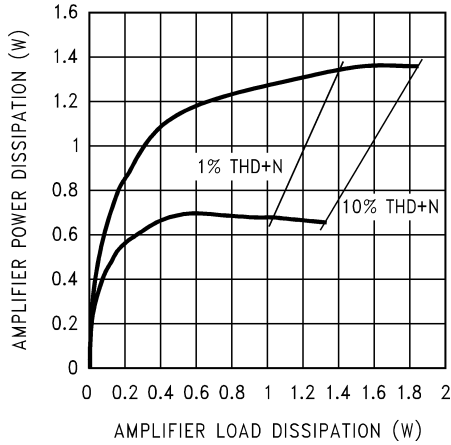

$V_{DD} = 5V$ ,  $f_{IN} = 1kHz$ , at (from top to bottom at 1W):  
 $R_L = 4\Omega$ ,  $R_L = 8\Omega$ , single channel driven and loaded

**Amplifier Power Dissipation vs Amplifier Load Dissipation**

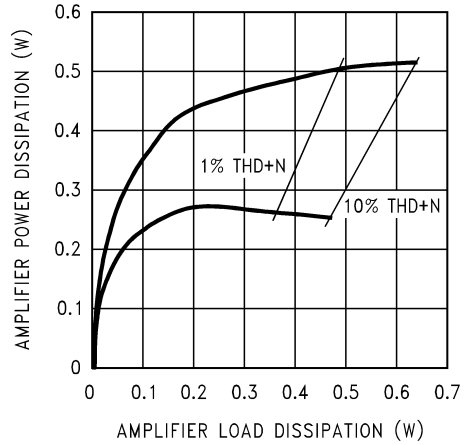

$V_{DD} = 3V$ ,  $f_{IN} = 1kHz$ , at (from top to bottom at 0.3W):  
 $R_L = 4\Omega$ ,  $R_L = 8\Omega$ , single channel driven and loaded

**Cross Talk vs Frequency**

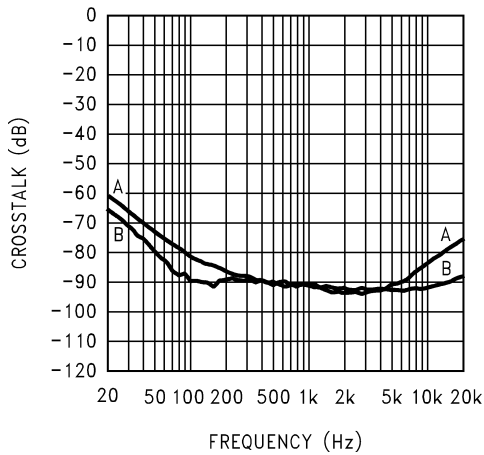

$V_{DD} = 5V$ ,  $R_L = 8\Omega$ ,  $A_V = 6dB$ ,  
A = Left channel driven, right channel measured;  
B = Right channel driven, left channel measured

**Cross Talk vs Frequency**

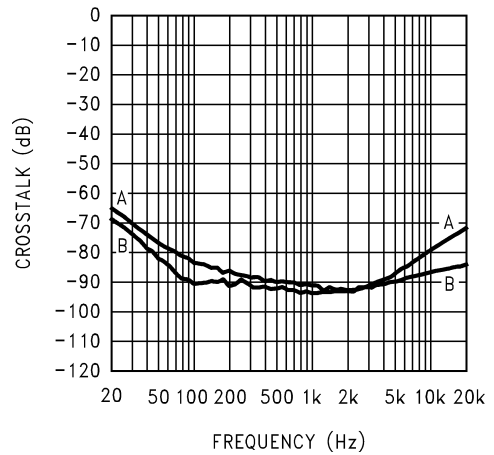

$V_{DD} = 5V$ ,  $R_L = 8\Omega$ ,  $A_V = 10dB$ ,  
A = Left channel driven, right channel measured;  
B = Right channel driven, left channel measured

## Typical Performance Characteristics

### MH Specific Characteristics (Continued)

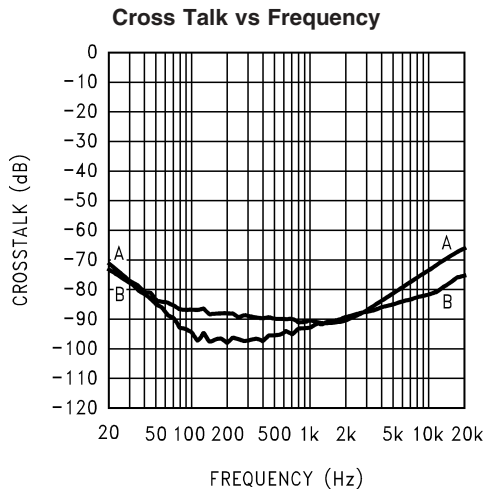

$V_{DD} = 5V$ ,  $R_L = 8\Omega$ ,  $A_V = 15.6dB$ ,  
**A = Left channel driven, right channel measured;**  
**B = Right channel driven, left channel measured**

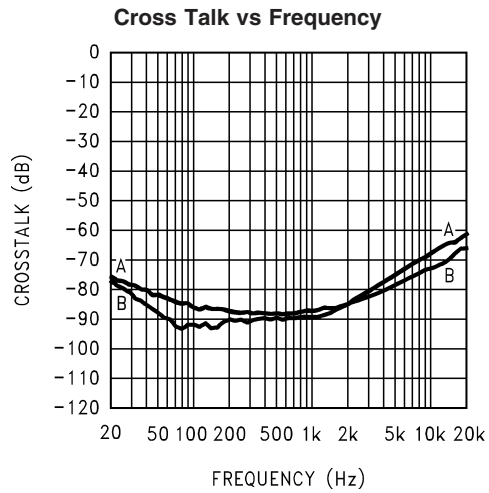

$V_{DD} = 5V$ ,  $R_L = 8\Omega$ ,  $A_V = 21.6dB$ ,  
**A = Left channel driven, right channel measured;**  
**B = Right channel driven, left channel measured**

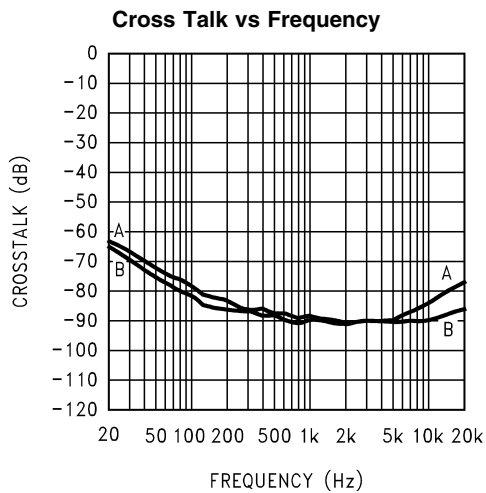

$V_{DD} = 3V$ ,  $R_L = 8\Omega$ ,  $A_V = 6dB$ ,  
**A = Left channel driven, right channel measured;**  
**B = Right channel driven, left channel measured**

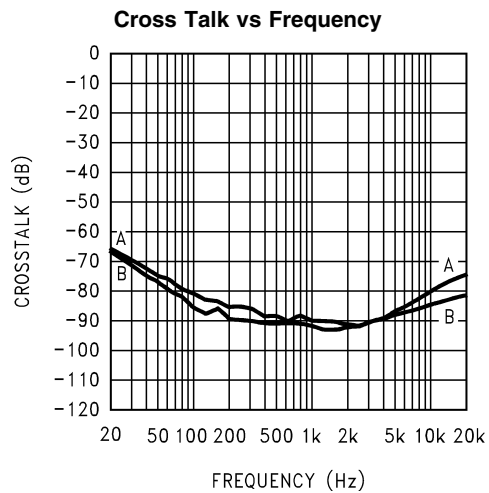

$V_{DD} = 3V$ ,  $R_L = 8\Omega$ ,  $A_V = 10dB$ ,  
**A = Left channel driven, right channel measured;**  
**B = Right channel driven, left channel measured**

## Typical Performance Characteristics MH Specific Characteristics (Continued)

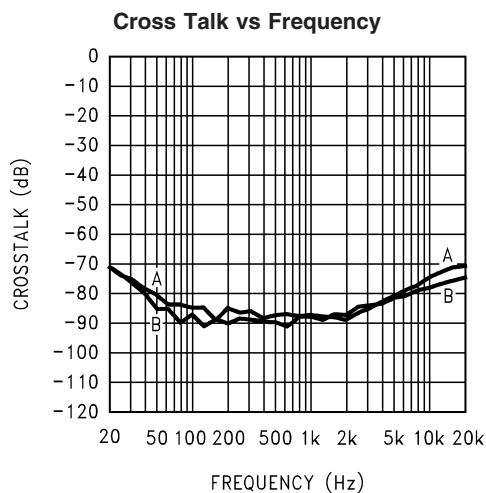

200428D5

$V_{DD} = 3V$ ,  $R_L = 8\Omega$ ,  $A_V = 15.6dB$ ,  
**A = Left channel driven, right channel measured;**  
**B = Right channel driven, left channel measured**

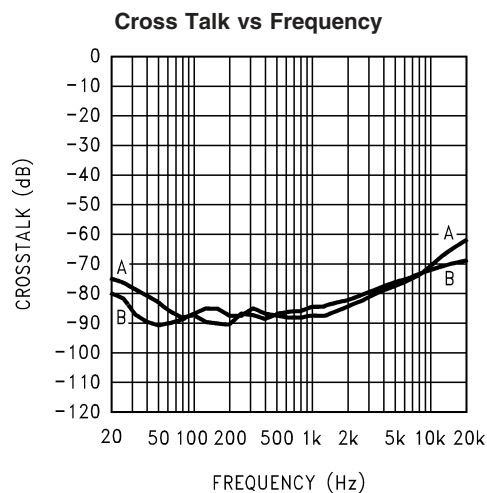

200428D6

$V_{DD} = 3V$ ,  $R_L = 8\Omega$ ,  $A_V = 21.6dB$ ,  
**A = Left channel driven, right channel measured;**  
**B = Right channel driven, left channel measured**

### Power Dissipation Derating Curves

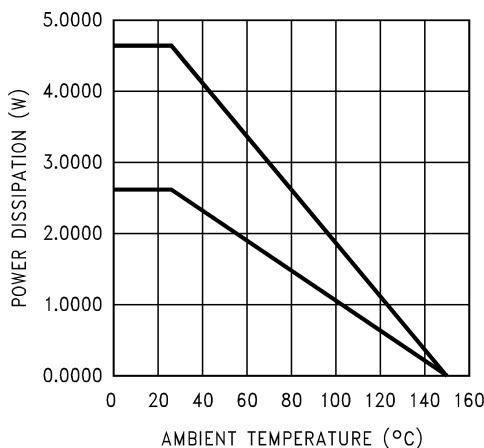

200428E4

$V_{DD} = 5V$ ,  $R_L = 8\Omega$ ,  $f_{IN} = 1kHz$ ,  
 (from top to bottom at 40°C): 3in x 3in four-layer PCB  
 with bottom and two inner layers connected to the package's DAP,  
 1.5in x 1.5in two-layer PCB with bottom and top layer  
 planes connected to the package's DAP

## Application Information

### PCB LAYOUT AND SUPPLY REGULATION CONSIDERATIONS FOR DRIVING 3W AND 4W LOADS

Power dissipated by a load is a function of the voltage swing across the load and the load's impedance. As load impedance decreases, load dissipation becomes increasingly dependent on the interconnect (PCB trace and wire) resistance between the amplifier output pins and the load's connections. Residual trace resistance causes a voltage drop, which results in power dissipated in the trace and not in the load as desired. For example, 0.1Ω trace resistance reduces the output power dissipated by a 4Ω load from 2.1W to 2.0W. This problem of decreased load dissipation is exacerbated

as load impedance decreases. Therefore, to maintain the highest load dissipation and widest output voltage swing, PCB traces that connect the output pins to a load must be as wide as possible.

Poor power supply regulation also adversely affects maximum output power. A poorly regulated supply's output voltage decreases with increasing load current. Reduced supply voltage causes decreased headroom, output signal clipping, and reduced output power. Even with tightly regulated supplies, trace resistance creates the same effects as poor supply regulation. Therefore, making the power supply traces as wide as possible helps maintain full output voltage swing.

## Application Information (Continued)

### BRIDGE CONFIGURATION EXPLANATION

As shown in Figure 1, each of the LM4869's stereo channels consists of two operational amplifiers. The LM4869 can be used to drive a speaker connected between the two outputs of each channel's amplifiers.

Figure 1 shows that the output of Amp1 serves as the input to Amp2, which results in both amplifiers producing signals identical in magnitude, but 180° out of phase. Taking advantage of this phase difference, a load is placed between OUT+ and OUT- and driven differentially (commonly referred to as 'bridge mode'). This results in a differential gain of

$$A_{VD} = 2(R_F/R_I) \quad (1)$$

Bridge mode is different from single-ended amplifiers that drive loads connected between a single amplifier's output and ground. For a given supply voltage, bridge mode has a distinct advantage over the single-ended configuration: its differential output doubles the voltage swing across the load. This results in four times the output power when compared to a single-ended amplifier under the same conditions. This increase in attainable output assumes that the amplifier is not current limited or the output signal is not clipped. To ensure minimum output signal clipping when selecting one of the amplifier's four closed-loop gains, refer to the **Audio Power Amplifier Design** section.

Another advantage of the differential bridge output is no net DC voltage across the load. This results from biasing OUT+ and OUT- at half-supply. This eliminates the coupling capacitor that single supply, single-ended amplifiers require. Eliminating an output coupling capacitor in a single-ended configuration forces a single supply amplifier's half-supply bias voltage across the load. The current flow created by the half-supply bias voltage increases internal IC power dissipation and may permanently damage loads such as speakers.

### POWER DISSIPATION

Power dissipation is a major concern when designing a successful bridged or single-ended amplifier. Equation (2) states the maximum power dissipation point for a single-ended amplifier operating at a given supply voltage and driving a specified output load.

$$P_{D_{MAX}} = (V_{DD})^2 / (2\pi^2 R_L) \quad \text{Single-Ended} \quad (2)$$

However, a direct consequence of the increased power delivered to the load by a bridge amplifier is an increase in the internal power dissipation point for a bridge amplifier operating at the same given conditions.

$$P_{D_{MAX}} = 4 * (V_{DD})^2 / (2\pi^2 R_L) \quad \text{Bridge Mode} \quad (3)$$

The LM4869 has four operational amplifiers in one package and the maximum internal power dissipation is four times that of a single-ended amplifier. From Equation (3), assuming a 5V power supply and an 8Ω load, the maximum power dissipation point is 2W. The maximum power dissipation point obtained from Equation (3) must not exceed the power dissipation predicted by Equation (4):

$$P_{D_{MAX}} = (T_{J_{MAX}} - T_A) / \theta_{JA} \quad (4)$$

For the exposed DAP TSSOP package,  $\theta_{JA} = 41^\circ\text{C/W}$ .  $T_{J_{MAX}} = 150^\circ\text{C}$  for the LM4869. For a given ambient temperature  $T_A$ , Equation (4) can be used to find the maximum internal power dissipation supported by the IC packaging. If the result of Equation (3) is greater than that of Equation (4), decrease the supply voltage, increase the load impedance, or reduce the ambient temperature. For a typical application with a 5V power supply and an 8Ω load, the maximum ambient temperature that does not violate the maximum junction temperature is approximately 68°C. This further assumes that a device is a surface mount part operating around the maximum power dissipation point. Since internal power dissipation is a function of output power, higher ambient temperatures are allowed as output power decreases. Refer to the Typical Performance Characteristics curves for power dissipation information at lower output power levels.

### BTL GAIN SELECTION

The LM4869 features four fixed, internally set, BTL voltage gains: 6dB, 10dB, 15.6dB, and 21.6dB. Select one of the four gains by applying a logic level signal to the GAIN0 (MSB) and GAIN1 (LSB) digital inputs.

The closed-loop gain of the first amplifier is adjustable, having four different gains, whereas two internal 20kΩ resistors set the second amplifier's gain at -1. Table 1 below, shows the state of the two logic inputs required to select one of the four gain values.

GAIN 0	GAIN 1	Selected Gain (dB)
0	0	6
0	1	10
1	0	15.6
1	1	21.6

### POWER SUPPLY BYPASSING

As with any power amplifier, proper supply bypassing is critical for low noise performance and high power supply rejection. The capacitors connected to the bypass and power supply pins should be placed as close to the LM4869 as possible. The capacitor connected between the bypass pin and ground improves the internal bias voltage's stability, producing improved PSRR. The improvements to PSRR increase as the bypass pin capacitor value increases.

Typical applications employ a 5V regulator with 10μF and a 0.1μF filter capacitors that aid in supply stability. Their presence, however, does not eliminate the need for bypassing the LM4869's supply pins. The selection of bypass capacitor values, especially  $C_B$ , depends on desired PSRR requirements, click and pop performance (as explained in the **Selecting External Components** section), system cost, and size constraints.

### MICRO-POWER SHUTDOWN

The LM4869 features an active-low micro-power shutdown mode. The voltage applied to the SHUTDOWN pin controls the LM4869's shutdown function. Activate micro-power shutdown by applying 0V to the SHUTDOWN pin. The logic threshold is typically 0.4V for a logic low and 1.5V for a logic high. When active, the LM4869's micro-power shutdown feature turns off the amplifier's bias circuitry, disables the internal  $V_{DD}/2$  generator, and forces the amplifier outputs into a high impedance state. The result is greatly reduced power supply current. The low 0.1μA typical shutdown current is achieved by applying a voltage to the SHUTDOWN

## Application Information (Continued)

pin that is as near to GND as possible. A voltage that is greater than GND may increase the shutdown current.

There are a few methods to control the micro-power shutdown. These include using a single-pole, single-throw switch (SPST), a microprocessor, or a microcontroller. When using a switch, connect a 100kΩ pull-down resistor between the SHUTDOWN pin and GND and the SPST switch between the SHUTDOWN pin and  $V_{DD}$ . Select normal amplifier operation by closing the switch. Opening the switch applies GND to the SHUTDOWN pin, activating micro-power shutdown. The switch and resistor guarantee that the SHUTDOWN pin will not float. This prevents unwanted state changes. In a system with a microprocessor or a microcontroller, use a digital output to apply the active-state voltage to the SHUTDOWN pin. Driving the SHUTDOWN pin with active circuitry eliminates the pull-down resistor.

**Table 1. LOGIC LEVEL TRUTH TABLE FOR SHUTDOWN OPERATION**

SHUTDOWN	OPERATIONAL MODE
High	Full Power, stereo BTL amplifiers
Low	Micro-power Shutdown

### SELECTING PROPER EXTERNAL COMPONENTS

Optimizing the LM4869's performance requires properly selecting external components. Though the LM4869 operates well when using external components with wide tolerances, best performance is achieved by optimizing component values. The LM4869 is unity-gain stable, giving a designer maximum design flexibility. The gain should be set to no more than a given application requires. This allows the amplifier to achieve minimum THD+N and maximum signal-to-noise ratio. These parameters are compromised as the closed-loop gain increases. However, low gain demands input signals with greater voltage swings to achieve maximum output power. Fortunately, many signal sources such as audio CODECs have outputs of  $1V_{RMS}$  (2.83V<sub>P-P</sub>). Please refer to the Audio Power Amplifier Design section for more information on selecting the proper gain.

### Input Capacitor Value Selection

Amplifying the lowest audio frequencies requires high value input coupling capacitors ( $C_1$ ,  $C_2$  and  $C_3$ ,  $C_4$ ) in Figure 1. A high value capacitor can be expensive and may compromise space efficiency in portable designs. In many cases, however, the speakers used in portable systems, whether internal or external, have little ability to reproduce signals with frequencies below 150Hz. Applications using speakers with this limited frequency response reap little improvement by using large input capacitor.

Besides effecting system cost and size,  $C_1$  -  $C_4$  can also affect on the LM4869's turn-on and turn-off transient ('click and pop') performance. When the supply voltage is first applied, a transient may be created as the charge on the input capacitor changes from zero to a quiescent state. The

magnitude of the transient is proportional to the value of, and more importantly, the mismatch between, the capacitors connected to a given pair of inverting and non-inverting inputs. The better the match, the less the transient magnitude.

Higher value capacitors need more time to reach a quiescent DC voltage (usually  $V_{DD}/2$ ) when charged with a fixed current. This fixed current is supplied through amplifiers input pins. Thus, selecting an input capacitor value that is no higher than necessary to meet the desired -3dB frequency will reduce turn-on time and help ensure that transients are minimized.

The LM4869's nominal input resistance ( $R_i$ ) is 25kΩ (20kΩ, minimum) and the input capacitor,  $C_i$ , form high pass filter with a -3dB low frequency limit defined by equation (5).

$$f_{-3dB} = 1/2\pi(25k\Omega)C_i \quad (5)$$

As an example when using a speaker with a low frequency limit of 150Hz,  $C_i$  is 0.047μF. The 0.47μF  $C_i$  shown in Figure 1 allows the LM4869 to drive high efficiency, full range speaker whose response extends below 30Hz.

### Bypass Capacitor Value Selection

Besides optimizing the input capacitor value, careful consideration should be paid to value of  $C_B$ , the capacitor connected between the BYPASS pin and ground. Since  $C_B$  determines how fast the LM4869 settles to its quiescent operating state, its value is critical when minimizing turn-on transients. The slower the LM4869's outputs ramp to their quiescent DC voltage (nominally  $1/2 V_{DD}$ ), the smaller the turn-on transient. Choosing  $C_B$  equal to 0.47μF along with a small value of  $C_i$  (in the range of 0.047μF to 0.47μF), produces a transient-free turn-on and shutdown function. As discussed above, choosing  $C_i$  no larger than necessary for the desired bandwidth helps minimize turn-on transients.

### OPTIMIZING OUTPUT TRANSIENT REDUCTION (CLICK AND POP PERFORMANCE)

The LM4869 contains circuitry to minimize turn-on and shutdown transients or 'clicks and pop'. For this discussion, turn-on refers to either applying the power supply voltage or when the shutdown mode is deactivated. While the power supply voltage is ramping to its final value, the LM4869's internal amplifiers are configured as unity gain buffers. An internal current source changes the voltage of the BYPASS pin in a controlled, linear manner. Ideally, the amplifier inputs and outputs track the voltage applied to the BYPASS pin. The gain of the internal amplifiers remains unity until the voltage on the bypass pin reaches  $1/2 V_{DD}$ . As soon as the voltage on the BYPASS pin is stable, the device becomes fully operational. Although the bypass pin current can not be modified, changing the size of  $C_B$  alters the device's turn-on time and the magnitude of output transients. Increasing the value of  $C_B$  reduces the magnitude of turn-on transients. However, this presents a tradeoff: as the size of  $C_B$  increases, the turn-on time increases. There is a linear relationships between the size of  $C_B + 2(C_i)$  and the turn-on time. The table shows some typical turn-on times for various values of  $C_B$ :



## Application Information (Continued)

C <sub>B</sub>	T <sub>on</sub>	
	C <sub>i</sub> = 0.47μF	C <sub>i</sub> = 0.33μF
0.01μF	110ms	80ms
0.1μF	120ms	90ms
0.22μF	140ms	100ms
0.47μF	170ms	140ms
1.0μF	240ms	210ms

In order to eliminate 'clicks and pops', all capacitors must be discharged before turn-on. Rapidly switching V<sub>DD</sub> may not allow the capacitors to fully discharge, which may cause 'clicks and pops'.

### AUDIO POWER AMPLIFIER DESIGN

#### Audio Amplifier Design: Driving 1W into an 8Ω Load

The following are the desired operational parameters:

Power Output:	1 W <sub>RMS</sub>
Load Impedance:	8Ω
Input Level:	1 V <sub>RMS</sub>
Input Impedance:	20 kΩ
Bandwidth:	100 Hz–20 kHz ± 0.25 dB

The design begins by specifying the minimum supply voltage necessary to obtain the desired output power. One way to find the minimum supply voltage is to use the Output Power vs Supply Voltage curve in the **Typical Performance Characteristics** section. Another way, using Equation (6), is to calculate the peak output voltage necessary to achieve the desired output power for a given load impedance. To account for the amplifier's dropout voltage, two additional voltages, based on the Dropout Voltage vs Supply Voltage in the **Typical Performance Characteristics** curves, must be added to the result obtained by Equation (6). The result is Equation (7).

$$V_{\text{outpeak}} = \sqrt{(2R_L P_O)} \quad (6)$$

$$V_{DD} \geq (V_{\text{OUTPEAK}} + (V_{\text{ODTOP}} + V_{\text{ODBOT}})) \quad (7)$$

The Output Power vs Supply Voltage graph for an 8Ω load indicates a minimum supply voltage of 4.6V. This is easily met by the commonly used 5V supply voltage. The additional voltage creates the benefit of headroom, allowing the LM4869 to produce peak output power in excess of 1W without clipping or other audible distortion. The choice of supply voltage must also not create a situation that violates of maximum power dissipation as explained above in the **Power Dissipation** section.

After satisfying the LM4869's power dissipation requirements, the minimum differential gain is found using Equation (8).

$$A_{VD} \geq \sqrt{(P_O R_L)} / (V_{IN}) = V_{\text{orms}} / V_{\text{inrms}} \quad (8)$$

Thus, a minimum gain of 2.83 allows the LM4869's to reach full output swing and maintain low noise and THD+N performance. For this example, let A<sub>VD</sub> = 3. In the example design, the gain will be set to 10dB (A<sub>VD</sub> = 3.2) by applying a logic low to GAIN 0 and a logic high to GAIN 1.

The last step in this design example is setting the amplifier's -3dB frequency bandwidth. To achieve the desired ±0.25dB pass band magnitude variation limit, the low frequency response must extend to at least one-fifth the lower bandwidth limit and the high frequency response must extend to at least five times the upper bandwidth limit. This extended bandwidth produces a gain variation of -0.17dB at the bandwidth's limits, well within the ±0.25dB desired limit. The results are an

$$f_L = 100\text{Hz}/5 = 20\text{Hz} \quad (9)$$

and an

$$f_H = 20\text{kHz} \times 5 = 100\text{kHz} \quad (10)$$

As mentioned in the External Components section, the internal input resistor and C<sub>i</sub> create a high pass filter that sets the amplifier's lower bandpass frequency limit. Find the coupling capacitor's value using Equation (11).

$$f_{-3\text{dB}} = 1/2\pi(20\text{k}\Omega)C_i \quad (11)$$

The result is (using the minimum R<sub>IN</sub> resistor value to ensure correct magnitude response at 20Hz)

$$1/(2\pi * 20\text{k}\Omega * 20\text{Hz}) = 0.398\mu\text{F} \quad (12)$$

Use a 0.39μF capacitor, the closest standard value. The product of the desired high frequency cutoff (100kHz in this example) and the differential gain, A<sub>VD</sub>, determines the upper passband response limit. With A<sub>VD</sub> = 3.2 and f<sub>H</sub> = 100kHz, the closed-loop gain bandwidth product (GBWP) is 320kHz. This is less than the LM4869's 3.5MHz GBWP. With this margin, the amplifier can be used in designs that require more differential gain while avoiding performance-restricting bandwidth limitations.

## RECOMMENDED PRINTED CIRCUIT BOARD LAYOUT

Figures 2 through 6 show the recommended four-layer PC board layout that is optimized for the 20-pin MH-packaged LM4869 and associated external components. This circuit is designed for use with an external 5V supply and 3Ω (or higher) speakers (or load resistors).

This circuit board is easy to use. Apply 5V and ground to the board's V<sub>DD</sub> and GND terminals, respectively. Connect speakers (or load resistors) between the board's -OUTA and +OUTA and -OUTB and +OUTB pads. Apply balanced differential stereo input signals to the input pins labeled '-INA,' '+INA,' '-INB,' and '+INB.'

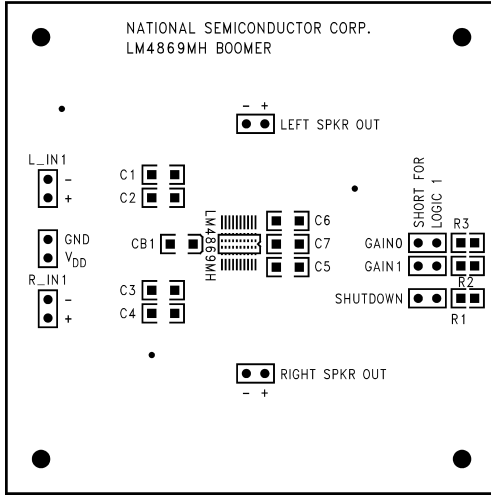

200428D7

FIGURE 2. Recommended MH PC Board Layout: Component-Side Silkscreen

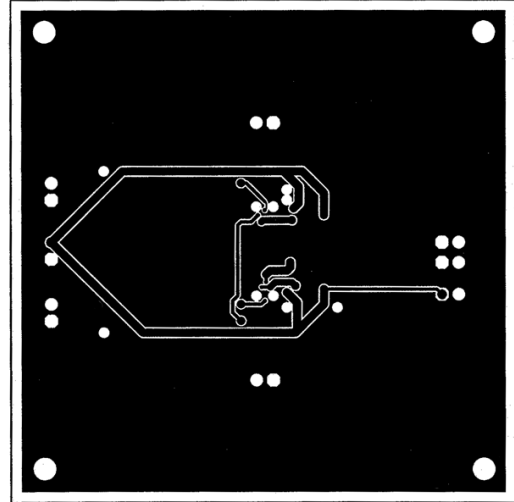

200428D9

FIGURE 4. Recommended MH PC Board Layout: Upper Inner-Layer Layout

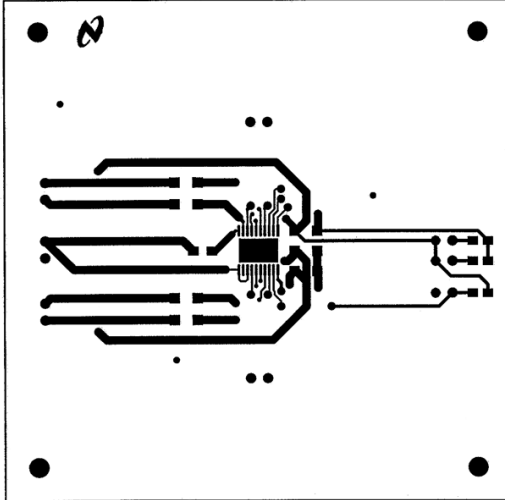

200428D8

FIGURE 3. Recommended MH PC Board Layout: Component-Side Layout

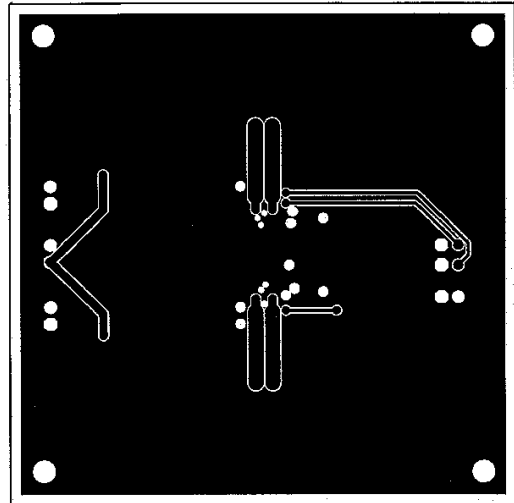

200428E0

FIGURE 5. Recommended MH PC Board Layout: Lower Inner-Layer Layout

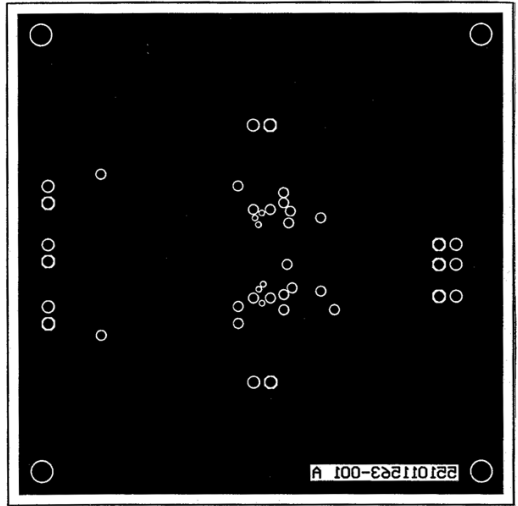

200428E1

**FIGURE 6. Recommended MH PC Board Layout:  
Bottom-Side Layout**

## Physical Dimensions inches (millimeters) unless otherwise noted

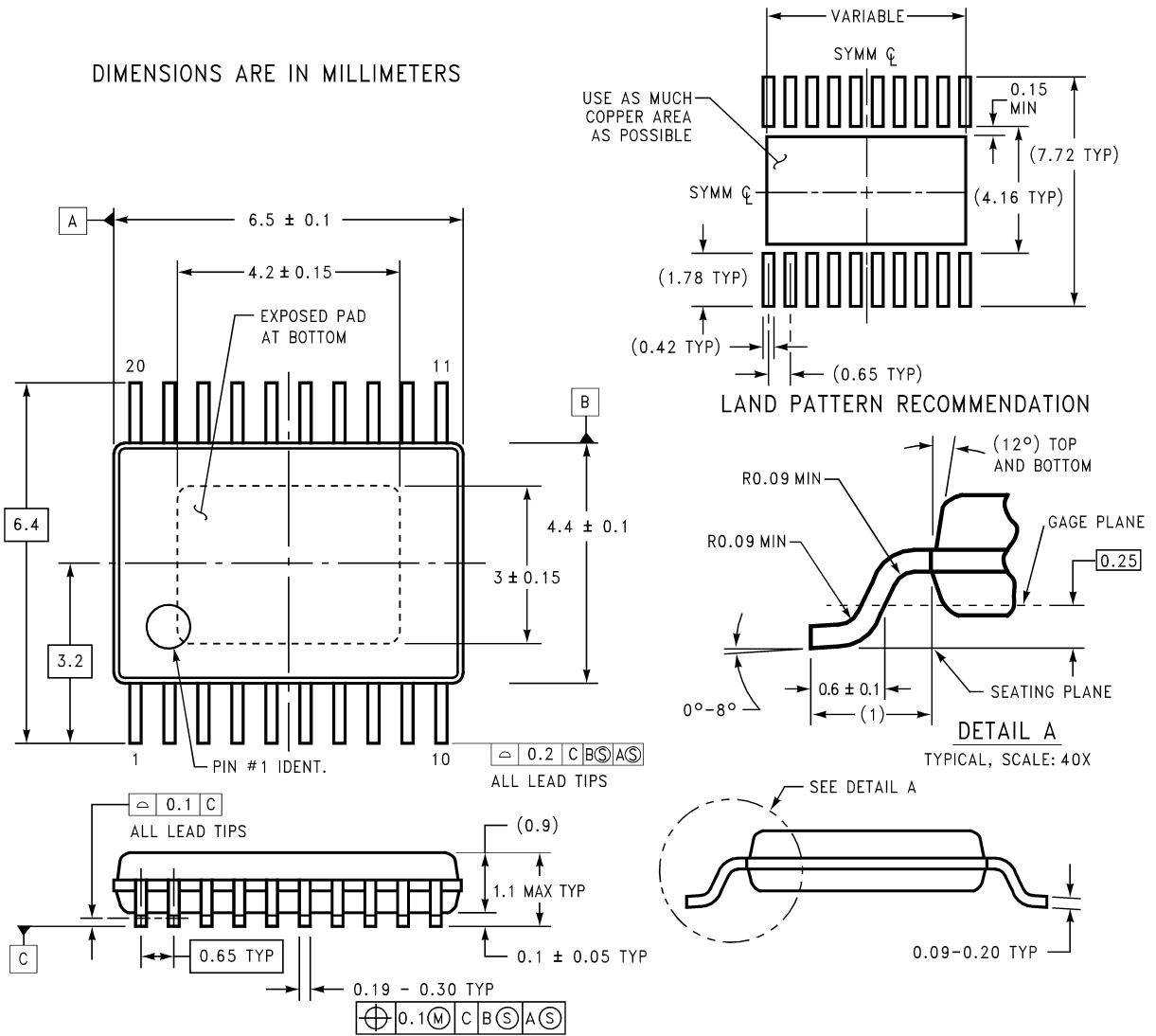

MXA20A (REV A)

**Exposed-DAP TSSOP Package**  
**Order Number LM4869MH**  
**NS Package Number MXA20A for Exposed-DAP TSSOP**

### LIFE SUPPORT POLICY

NATIONAL'S PRODUCTS ARE NOT AUTHORIZED FOR USE AS CRITICAL COMPONENTS IN LIFE SUPPORT DEVICES OR SYSTEMS WITHOUT THE EXPRESS WRITTEN APPROVAL OF THE PRESIDENT AND GENERAL COUNSEL OF NATIONAL SEMICONDUCTOR CORPORATION. As used herein:

1. Life support devices or systems are devices or systems which, (a) are intended for surgical implant into the body, or (b) support or sustain life, and whose failure to perform when properly used in accordance with instructions for use provided in the labeling, can be reasonably expected to result in a significant injury to the user.
2. A critical component is any component of a life support device or system whose failure to perform can be reasonably expected to cause the failure of the life support device or system, or to affect its safety or effectiveness.



**National Semiconductor Corporation**  
Americas  
Email: support@nsc.com

www.national.com

**National Semiconductor Europe**  
Fax: +49 (0) 180-530 85 86  
Email: europe.support@nsc.com  
Deutsch Tel: +49 (0) 69 9508 6208  
English Tel: +44 (0) 870 24 0 2171  
Français Tel: +33 (0) 1 41 91 8790

**National Semiconductor Asia Pacific Customer Response Group**  
Tel: 65-2544466  
Fax: 65-2504466  
Email: ap.support@nsc.com

**National Semiconductor Japan Ltd.**  
Tel: 81-3-5639-7560  
Fax: 81-3-5639-7507