

# LM4838 Boomer® Audio Power Amplifier Series

## Stereo 2W Audio Power Amplifiers

### with DC Volume Control and Selectable Gain

#### General Description

The LM4838 is a monolithic integrated circuit that provides DC volume control, and stereo bridged audio power amplifiers capable of producing 2W into 4Ω (Note 1) with less than 1.0% THD or 2.2W into 3Ω (Note 2) with less than 1.0% THD.

Boomer® audio integrated circuits were designed specifically to provide high quality audio while requiring a minimum amount of external components. The LM4838 incorporates a DC volume control, stereo bridged audio power amplifiers and a selectable gain or bass boost, making it optimally suited for multimedia monitors, portable radios, desktop, and portable computer applications.

The LM4838 features an externally controlled, low-power consumption shutdown mode, and both a power amplifier and headphone mute for maximum system flexibility and performance.

**Note 1:** When properly mounted to the circuit board, the LM4838LQ, LM4838MTE, and LM4838GR will deliver 2W into 4Ω. The LM4838MT and LM4838ITL will deliver 1.1W into 8Ω. See **Application Information** section **Exposed-DAP package PCB Mounting Considerations** for more information.

**Note 2:** An LM4838LQ and LM4838MTE that have been properly mounted to the circuit board and forced-air cooled will deliver 2.2W into 3Ω.

#### Key Specifications

■ P <sub>O</sub> at 1% THD+N	
■ into 3Ω (LQ & MTE)	2.2W (typ)
■ into 4Ω (LQ, MTE, GR)	2.0W (typ)
■ into 8Ω (MT, MTE, ITL, LQ, & GR)	1.1W (typ)
■ Single-ended mode - THD+N at 85mW into 32Ω	1.0%(typ)
■ Shutdown current	0.7μA (typ)

#### Features

- DC Volume Control Interface
- System Beep Detect
- Stereo switchable bridged/single-ended power amplifiers
- Selectable internal/external gain and bass boost
- "Click and pop" suppression circuitry
- Thermal shutdown protection circuitry

#### Applications

- Portable and Desktop Computers
- Multimedia Monitors
- Portable Radios, PDAs, and Portable TVs

#### Block Diagram

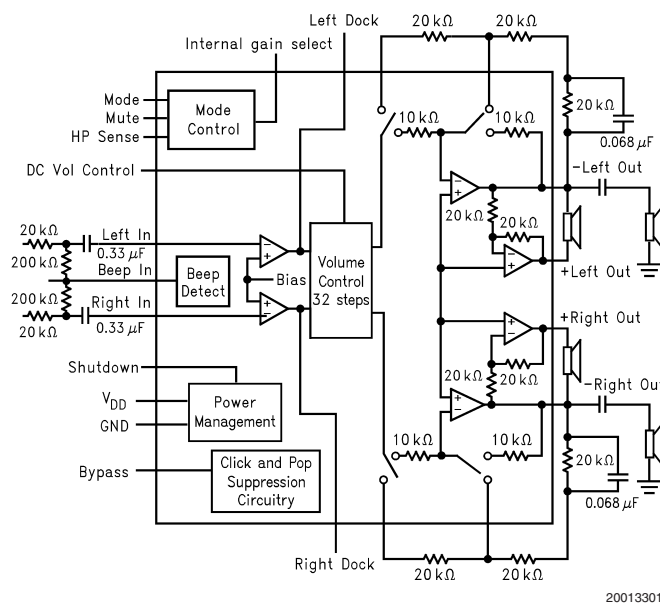
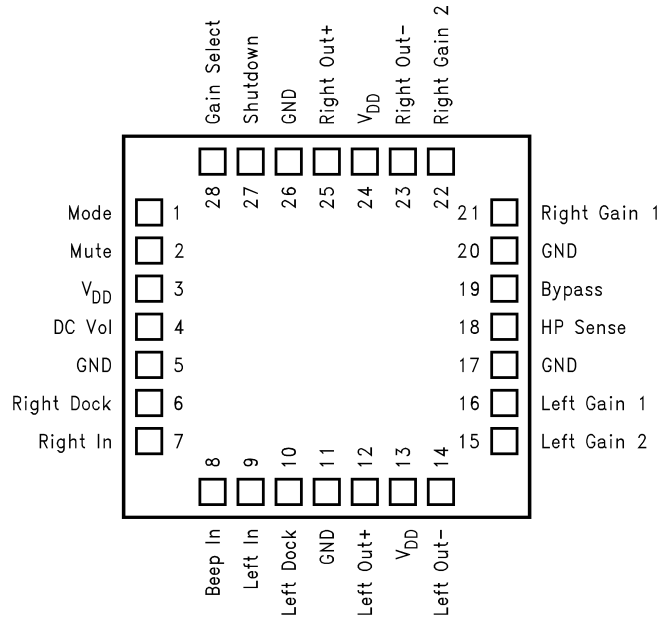

FIGURE 1. LM4838 Block Diagram

Boomer® is a registered trademark of National Semiconductor Corporation.

# Connection Diagrams

## LLP Package



20013335

### Top View

Order Number LM4838LQ

See NS Package Number LQA028AA for Exposed-DAP LLP

## TSSOP Package

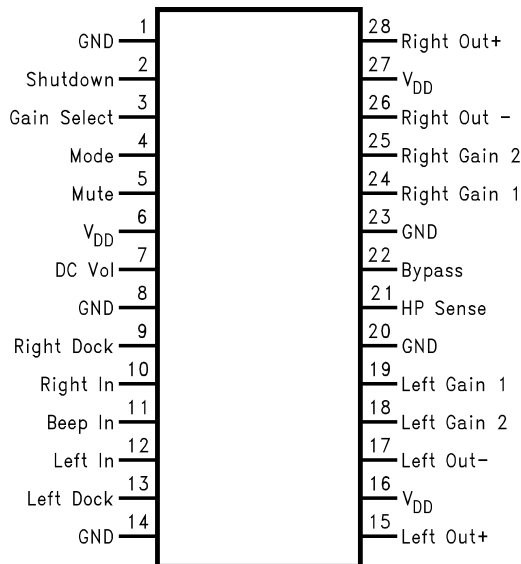

20013302

### Top View

Order Number LM4838MT

See NS Package Number MTC28 for TSSOP

Order Number LM4838MTE

See NS Package Number MXA28A for Exposed-DAP TSSOP

## Connection Diagrams (Continued)

### 36 Bump micro SMD

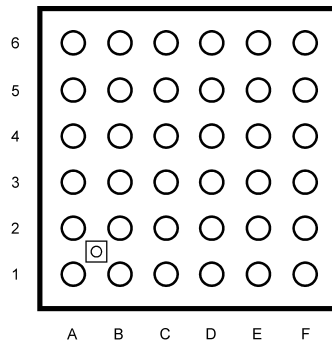

20013388

Top View

Order Number LM4838ITL, LM4838ITLX  
See NS Package Number TLA36AAA

### micro SMD Marking

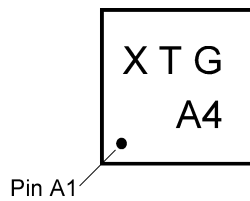

20013387

Top View

X - Date Code  
T - Die Traceability  
G - Boomer Family  
A4 - LM4838ITL

### 36 Bump micro SMD Pinout Table

6	NC	Right Out -	$V_{DD}$	Right Out +	GND	NC
5	GND	Right Gain 2	Right Gain 1	Gain Select	Shutdown	Mode
4	Bypass	NC	NC	DC Vol	Mute	$V_{DD}$
3	HP Sense	NC	NC	Beep In	Right Dock	GND
2	GND	Left Gain 2	Left Gain 1	Left In	Left Dock	Right In
1	NC	Left Out -	$V_{DD}$	Left Out +	GND	NC
Pin Designator	A	B	C	D	E	F

## Connection Diagrams

### 49 Bump micro Array

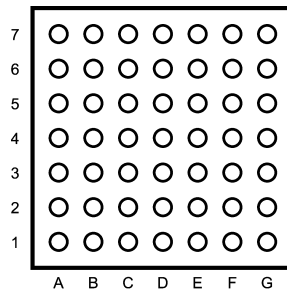

20013344

#### Top View

Order Number LM4838GR  
See NS Package Number GRA49A

### 49 Bump micro Array Marking

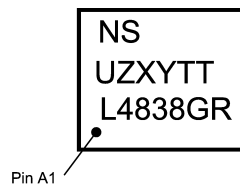

20013343

#### Top View

NS - Standard National Logo  
U - Wafer Fab Code  
Z - Assembly Plant Code  
XY - 2 Digit Datecode  
TT - Dierun Traceability  
L4838GR - LM4838GR

### 49 Bump LM4838GR Pinout Table

7	Right Out -	Right Gain 1	GND	Bypass	HP Sense	GND	Left Gain 1
6	Right Out -	Right Gain 2	GND	GND	GND	Left Gain 2	Left Out -
5	VDD	VDD	GND	GND	GND	Left Out -	VDD
4	Right Out +	Right Out +	GND	GND	GND	Left Out +	VDD
3	GND	GND	GND	GND	GND	GND	Left Out +
2	Shutdown	Gain Select	VDD	GND	Right In	Left In	GND
1	Mode	Mute	DC Vol	GND	Right Dock	Beep In	Left Dock
Pin Designator	A	B	C	D	E	F	G

**Absolute Maximum Ratings** (Note 10)

If Military/Aerospace specified devices are required, please contact the National Semiconductor Sales Office/Distributors for availability and specifications.

Supply Voltage	6.0V
Storage Temperature	-65°C to +150°C
Input Voltage	-0.3V to $V_{DD} + 0.3V$
Power Dissipation (Note 11)	Internally limited
ESD Susceptibility (Note 12)	2000V
ESD Susceptibility (Note 13)	200V
Junction Temperature	150°C
Soldering Information	
Small Outline Package	
Vapor Phase (60 sec.)	215°C
Infrared (15 sec.)	220°C

See AN-450 "Surface Mounting and their Effects on Product Reliability" for other methods of soldering surface mount devices.

$\theta_{JC}$ (typ) — LQA028AA	3°C/W
$\theta_{JA}$ (typ) — LQA028AA	42°C/W
$\theta_{JC}$ (typ) — MTC28	20°C/W

$\theta_{JA}$ (typ) — MTC28	80°C/W
$\theta_{JC}$ (typ) — MXA28A	2°C/W
$\theta_{JA}$ (typ) — MXA28A (exposed DAP) (Note 4)	41°C/W
$\theta_{JA}$ (typ) — MXA28A (exposed DAP) (Note 3)	54°C/W
$\theta_{JA}$ (typ) — MXA28A (exposed DAP) (Note 5)	59°C/W
$\theta_{JA}$ (typ) — MXA28A (exposed DAP) (Note 6)	93°C/W
$\theta_{JA}$ (typ) — ITL36AAA	100°C/W
$\theta_{JC}$ (typ) — ITL36AAA (Note 16)	65°C/W
$\theta_{JA}$ (typ) — GRA49A	100°C/W
$\theta_{JC}$ (typ) — GRA49A (Note 17)	54°C/W

**Operating Ratings**

Temperature Range

$$T_{MIN} \leq T_A \leq T_{MAX}$$

$$-40^\circ\text{C} \leq T_A \leq 85^\circ\text{C}$$

Supply Voltage

$$2.7V \leq V_{DD} \leq 5.5V$$

**Electrical Characteristics for Entire IC** (Notes 7, 10)

The following specifications apply for  $V_{DD} = 5V$  unless otherwise noted. Limits apply for  $T_A = 25^\circ\text{C}$ .

Symbol	Parameter	Conditions	LM4838		Units (Limits)
			Typical (Note 14)	Limit (Note 15)	
$V_{DD}$	Supply Voltage			2.7	V (min)
				5.5	V (max)
$I_{DD}$	Quiescent Power Supply Current	$V_{IN} = 0V, I_O = 0A$	15	30	mA (max)
$I_{SD}$	Shutdown Current	$V_{shutdown} = V_{DD}$	0.7	2.0	$\mu\text{A}$ (max)
$V_{IH}$	Headphone Sense High Input Voltage			4	V (min)
$V_{IL}$	Headphone Sense Low Input Voltage			0.8	V (max)

**Electrical Characteristics for Volume Attenuators** (Notes 7, 10)

The following specifications apply for  $V_{DD} = 5V$ . Limits apply for  $T_A = 25^\circ\text{C}$ .

Symbol	Parameter	Conditions	LM4838		Units (Limits)
			Typical (Note 14)	Limit (Note 15)	
$C_{RANGE}$	Attenuator Range	Gain with $V_{DCVol} = 5V$ , No Load		$\pm 0.75$	dB (max)
		Attenuation with $V_{DCVol} = 0V$ (BM & SE)		-75	dB (min)
$A_M$	Mute Attenuation	$V_{mute} = 5V$ , Bridged Mode (BM)		-78	dB (min)
		$V_{mute} = 5V$ , Single-Ended Mode (SE)		-78	dB (min)

**Electrical Characteristics for Single-Ended Mode Operation** (Notes 7, 10)

The following specifications apply for  $V_{DD} = 5V$ . Limits apply for  $T_A = 25^\circ\text{C}$ .

Symbol	Parameter	Conditions	LM4838		Units (Limits)
			Typical (Note 14)	Limit (Note 15)	
$P_O$	Output Power	THD = 1.0%; $f = 1\text{kHz}$ ; $R_L = 32\Omega$	85		mW
		THD = 10%; $f = 1\text{kHz}$ ; $R_L = 32\Omega$	95		mW

## Electrical Characteristics for Single-Ended Mode Operation (Notes 7, 10) (Continued)

10) (Continued)

The following specifications apply for  $V_{DD} = 5V$ . Limits apply for  $T_A = 25^\circ C$ .

Symbol	Parameter	Conditions	LM4838		Units (Limits)
			Typical (Note 14)	Limit (Note 15)	
THD+N	Total Harmonic Distortion+Noise	$V_{OUT} = 1V_{RMS}$ , $f=1kHz$ , $R_L = 10k\Omega$ , $A_{VD} = 1$	0.065		%
PSRR	Power Supply Rejection Ratio	$C_B = 1.0 \mu F$ , $f = 120 Hz$ , $V_{RIPPLE} = 200 mV_{rms}$	58		dB
SNR	Signal to Noise Ratio	$P_{OUT} = 75 mW$ , $R_L = 32\Omega$ , A-Wtd Filter	102		dB
$X_{talk}$	Channel Separation	$f=1kHz$ , $C_B = 1.0 \mu F$	65		dB

## Electrical Characteristics for Bridged Mode Operation (Notes 7, 10)

The following specifications apply for  $V_{DD} = 5V$ , unless otherwise noted. Limits apply for  $T_A = 25^\circ C$ .

Symbol	Parameter	Conditions	LM4838		Units (Limits)
			Typical (Note 14)	Limit (Note 15)	
$V_{OS}$	Output Offset Voltage	$V_{IN} = 0V$ , No Load	5	$\pm 50$	mV (max)
$P_O$	Output Power	THD + N = 1.0%; $f=1kHz$ ; $R_L = 3\Omega$ (Note 8)	2.2		W
		THD + N = 1.0%; $f=1kHz$ ; $R_L = 4\Omega$ (Note 9)	2		W
		THD = 1% (max); $f = 1 kHz$ ; $R_L = 8\Omega$	1.1	1.0	W (min)
		THD+N = 10%; $f = 1 kHz$ ; $R_L = 8\Omega$	1.5		W
THD+N	Total Harmonic Distortion+Noise	$P_O = 1W$ , $20 Hz < f < 20 kHz$ , $R_L = 8\Omega$ , $A_{VD} = 2$	0.3		%
		$P_O = 340 mW$ , $R_L = 32\Omega$	1.0		%
PSRR	Power Supply Rejection Ratio	$C_B = 1.0 \mu F$ , $f = 120 Hz$ , $V_{RIPPLE} = 200 mV_{rms}$ ; $R_L = 8\Omega$	74		dB
SNR	Signal to Noise Ratio	$V_{DD} = 5V$ , $P_{OUT} = 1.1W$ , $R_L = 8\Omega$ , A-Wtd Filter	93		dB
$X_{talk}$	Channel Separation	$f=1kHz$ , $C_B = 1.0 \mu F$	70		dB

**Note 3:** The  $\theta_{JA}$  given is for an MXA28A package whose exposed-DAP is soldered to an exposed  $2in^2$  piece of 1 ounce printed circuit board copper.

**Note 4:** The  $\theta_{JA}$  given is for an MXA28A package whose exposed-DAP is soldered to a  $2in^2$  piece of 1 ounce printed circuit board copper on a bottom side layer through 21 8mil vias.

**Note 5:** The  $\theta_{JA}$  given is for an MXA28A package whose exposed-DAP is soldered to an exposed  $1in^2$  piece of 1 ounce printed circuit board copper.

**Note 6:** The  $\theta_{JA}$  given is for an MXA28A package whose exposed-DAP is not soldered to any copper.

**Note 7:** All voltages are measured with respect to the ground pins, unless otherwise specified. All specifications are tested using the typical application as shown in Figure 1.

**Note 8:** When driving  $3\Omega$  loads from a 5V supply the LM4838LQ and LM4838MTE must be mounted to the circuit board and forced-air cooled.

**Note 9:** When driving  $4\Omega$  loads from a 5V supply the LM4838LQ, LM4838MTE, and LM4838GR must be mounted to the circuit board.

**Note 10:** *Absolute Maximum Ratings* indicate limits beyond which damage to the device may occur. *Operating Ratings* indicate conditions for which the device is functional, but do not guarantee specific performance limits. *Electrical Characteristics* state DC and AC electrical specifications under particular test conditions which guarantee specific performance limits. This assumes that the device is within the Operating Ratings. Specifications are not guaranteed for parameters where no limit is given, however, the typical value is a good indication of device performance.

**Note 11:** The maximum power dissipation must be derated at elevated temperatures and is dictated by  $T_{JMAX}$ ,  $\theta_{JA}$ , and the ambient temperature  $T_A$ . The maximum allowable power dissipation is  $P_{DMAX} = (T_{JMAX} - T_A) / \theta_{JA}$ . For the LM4838,  $T_{JMAX} = 150^\circ C$ , and the typical junction-to-ambient thermal resistance for each package can be found in the **Absolute Maximum Ratings** section above.

**Note 12:** Human body model, 100pF discharged through a 1.5k $\Omega$  resistor.

**Note 13:** Machine Model, 220pF – 240pF discharged through all pins.

**Note 14:** Typical values are measured at  $25^\circ C$  and represent the parametric norm.

**Note 15:** Limits are guaranteed to National's AOQL (Average Outgoing Quality Level). Datasheet min/max specification limits are guaranteed by design, test, or statistical analysis.

## Electrical Characteristics for Bridged Mode Operation (Notes 7, 10) (Continued)

**Note 16:** All bumps have the same thermal resistance and contribute equally when used to lower thermal resistance. The LM4838ITL demo board (views featured in the **Application Information** section) is a four layer board with two inner layers. The second inner layer is a  $V_{DD}$  plane with the bottom outside layer a GND plane. The planes measure 1,900mils x 1,750mils (48.26mm x 44.45mm) and aid in spreading heat due to power dissipation within the IC.

**Note 17:** All bumps have the same thermal resistance and contribute equally when used to lower thermal resistance. The LM4838GR Demo Board is a four layer PC Board with 2 inner layers. The second inner layer and bottom outside layers are both grounded. The planes measure 3200 x 3700 mills and aid in spreading heat due to power dissipation within the IC.

## Typical Application

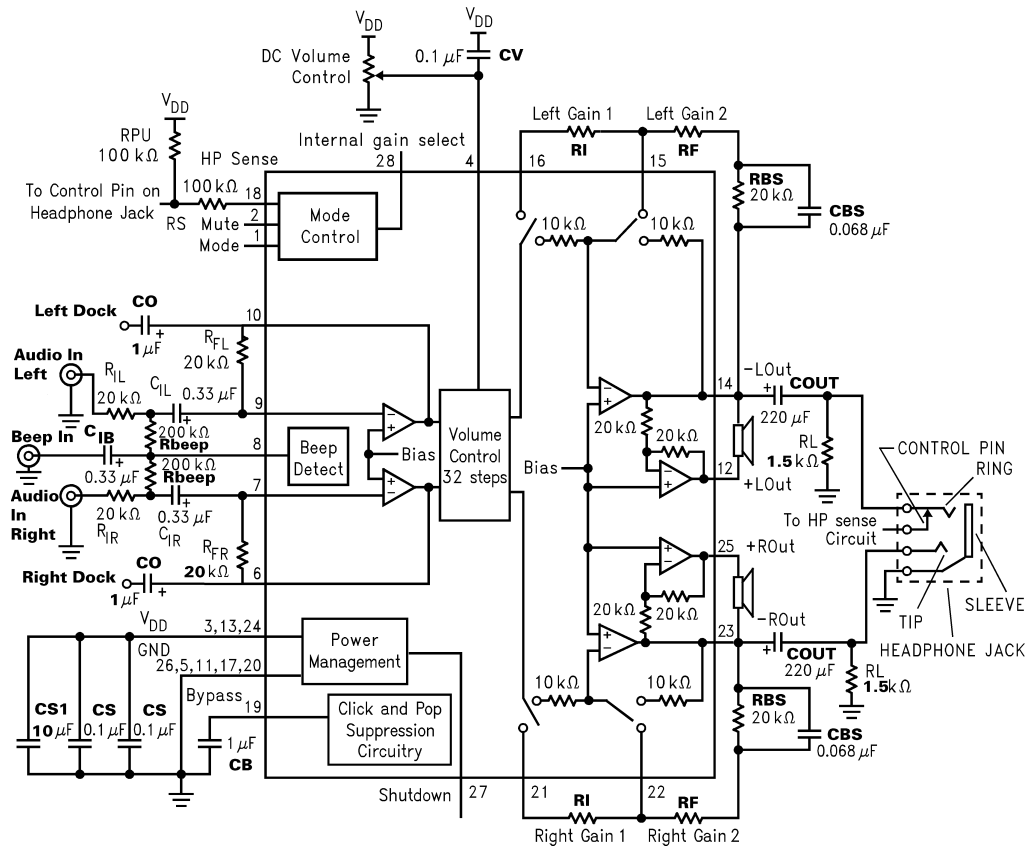

20013303

FIGURE 2. Typical Application Circuit ( LQ Package Pinout )

## Truth Table for Logic Inputs (Note 18)

Gain Sel	Mode	Headphone Sense	Mute	Shutdown	Output Stage Set To	DC Volume	Output Stage Configuration
0	0	0	0	0	Internal Gain	Fixed	BTL
0	0	1	0	0	Internal Gain	Fixed	SE
0	1	0	0	0	Internal Gain	Adjustable	BTL
0	1	1	0	0	Internal Gain	Adjustable	SE
1	0	0	0	0	External Gain	Fixed	BTL
1	0	1	0	0	External Gain	Fixed	SE
1	1	0	0	0	External Gain	Adjustable	BTL
1	1	1	0	0	External Gain	Adjustable	SE
X	X	X	1	0	Muted	X	Muted
X	X	X	X	1	Shutdown	X	X

**Note 18:** If system beep is detected on the Beep In pin, the system beep will be passed through the bridged amplifier regardless of the logic of the Mute and HP sense pins.

# Typical Performance Characteristics MTE Specific Characteristics

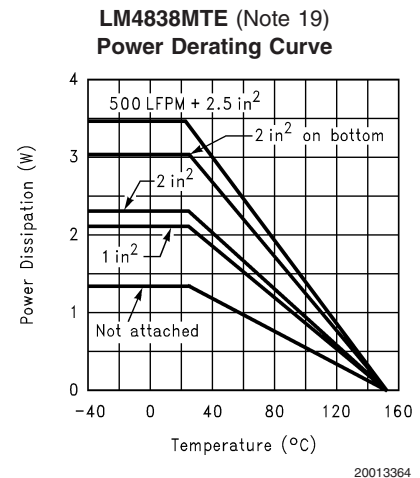
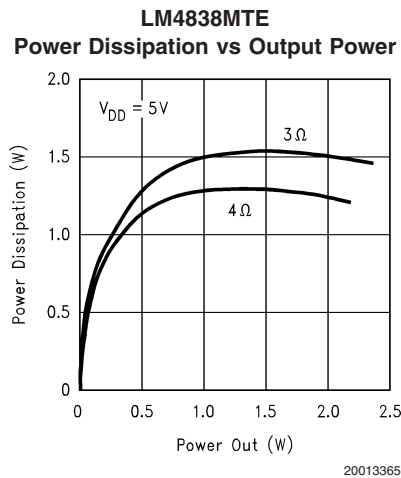
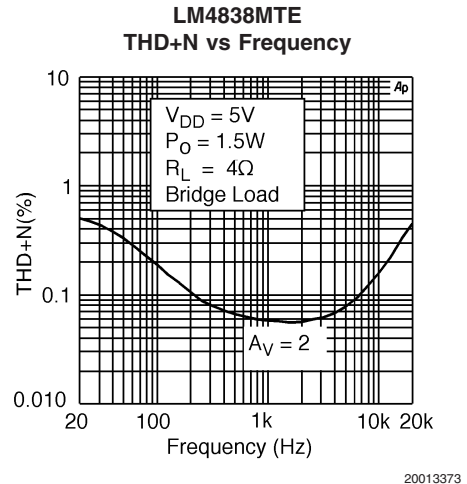
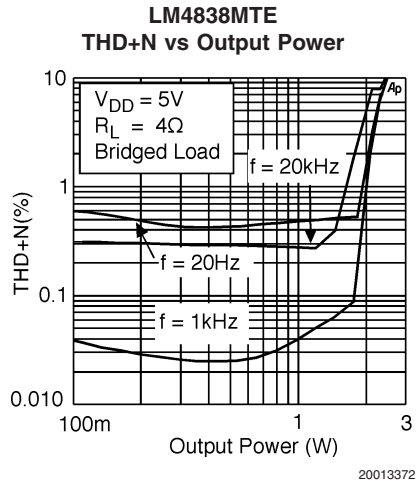
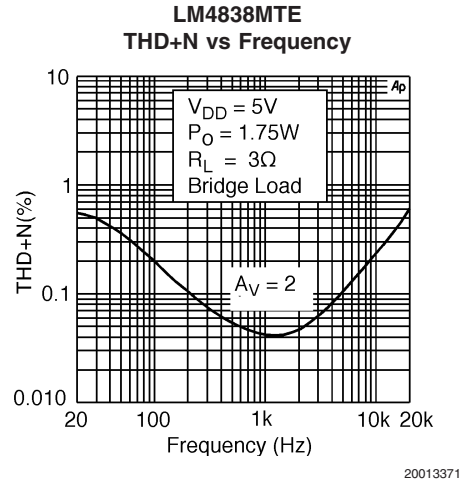
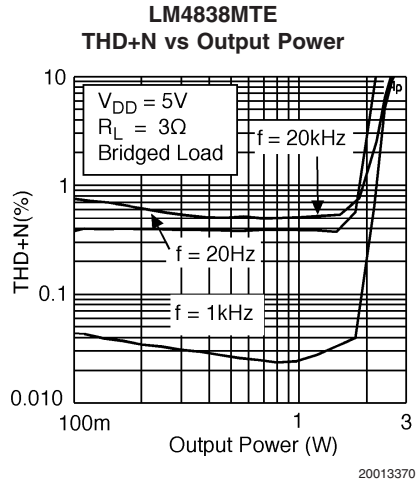

**Note 19:** These curves show the thermal dissipation ability of the LM4838MTE at different ambient temperatures given these conditions:

- 500LFPM + 2in<sup>2</sup>:** The part is soldered to a 2in<sup>2</sup>, 1 oz. copper plane with 500 linear feet per minute of forced-air flow across it.
- 2in<sup>2</sup>on bottom:** The part is soldered to a 2in<sup>2</sup>, 1oz. copper plane that is on the bottom side of the PC board through 21 8 mil vias.
- 2in<sup>2</sup>:** The part is soldered to a 2in<sup>2</sup>, 1oz. copper plane.
- 1in<sup>2</sup>:** The part is soldered to a 1in<sup>2</sup>, 1oz. copper plane.
- Not Attached:** The part is not soldered down and is not forced-air cooled.



# Typical Performance Characteristics

## Non-MTE Specific Characteristics

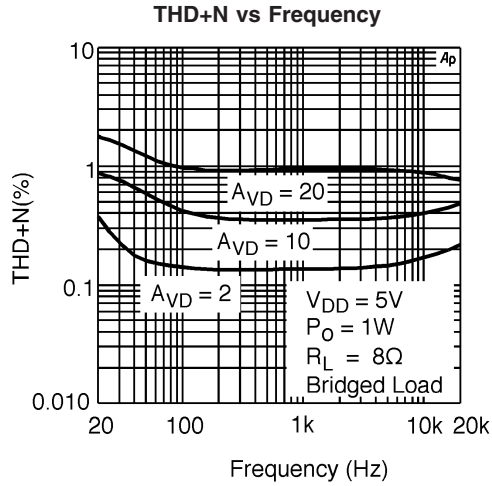

20013357

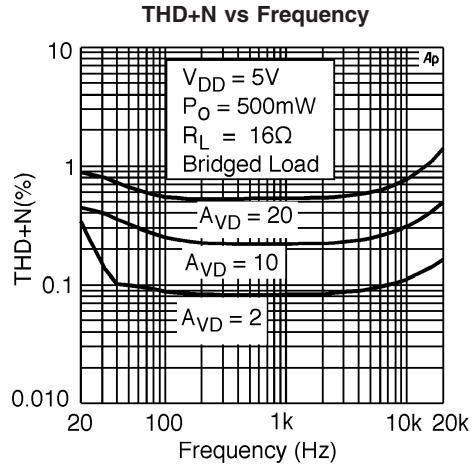

20013358

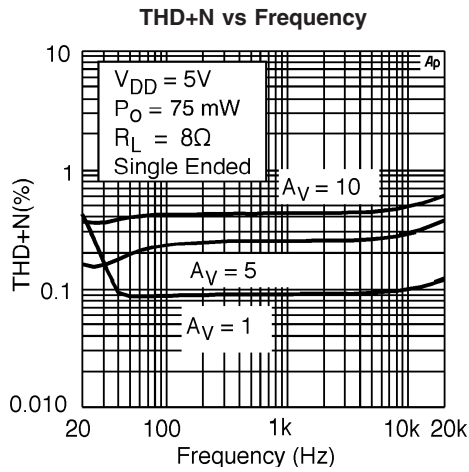

20013314

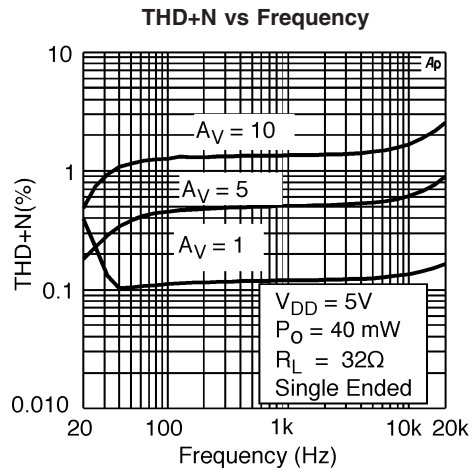

20013315

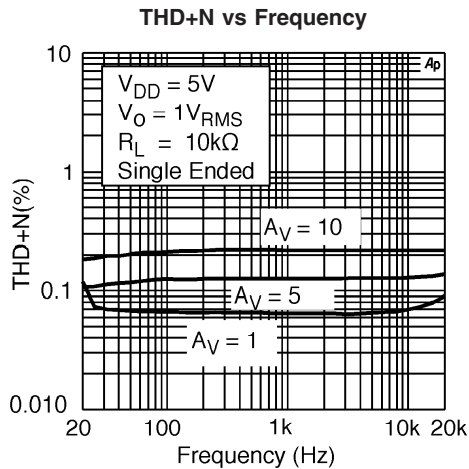

20013316

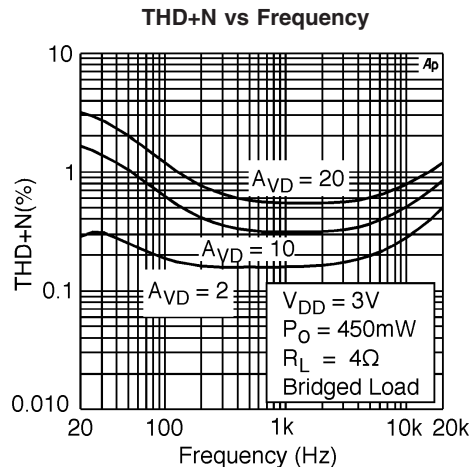

20013317

# Typical Performance Characteristics

## Non-MTE Specific Characteristics (Continued)

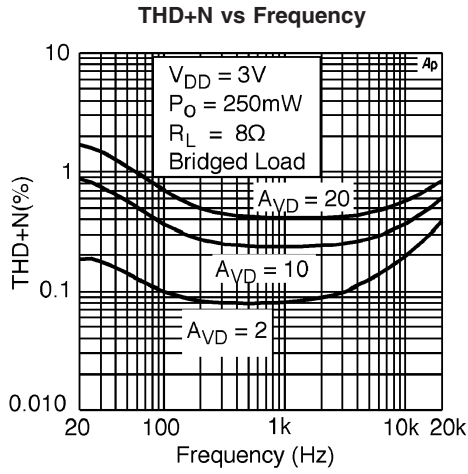

20013318

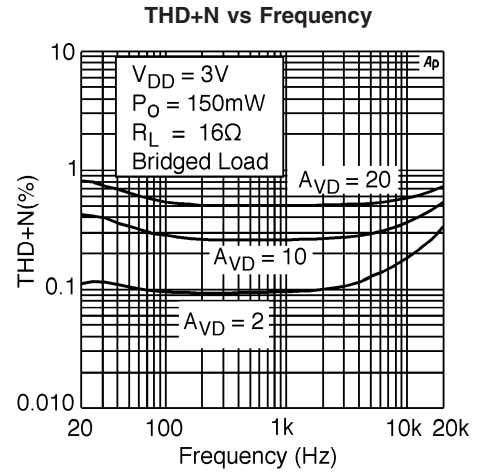

20013319

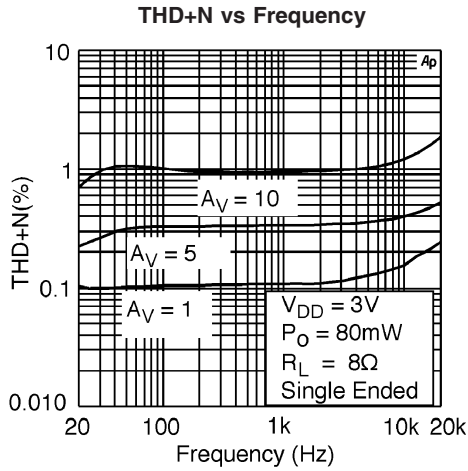

20013320

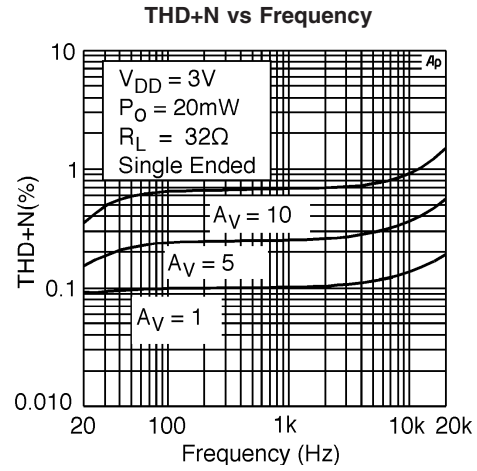

20013321

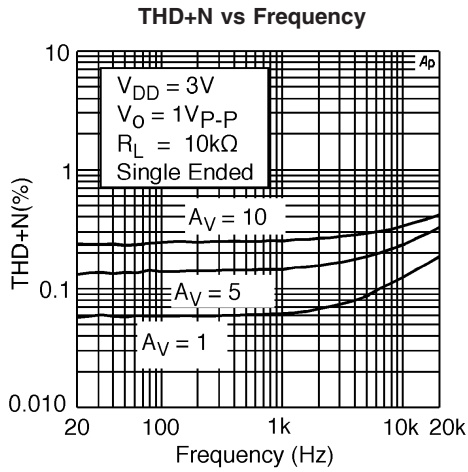

20013322

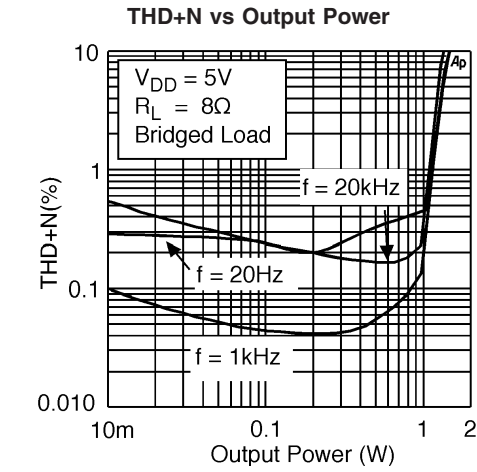

20013324

# Typical Performance Characteristics

## Non-MTE Specific Characteristics (Continued)

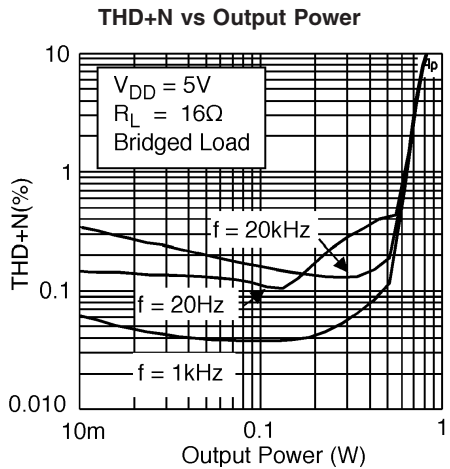

20013325

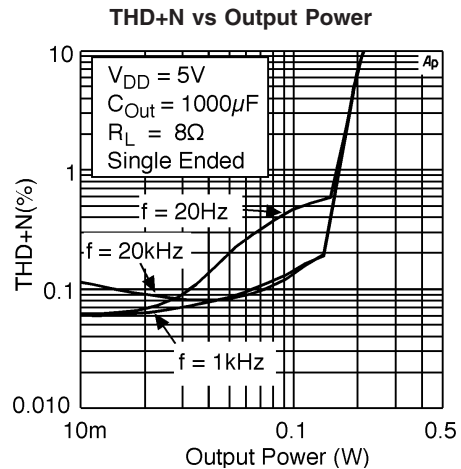

20013326

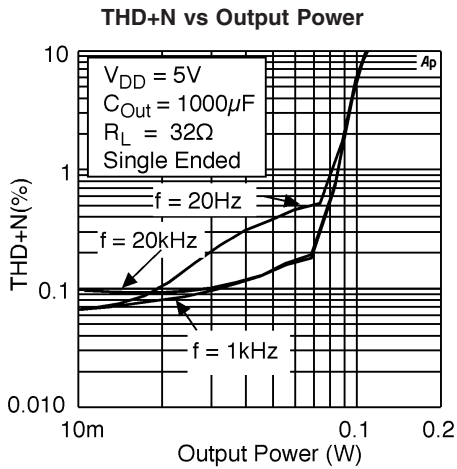

20013327

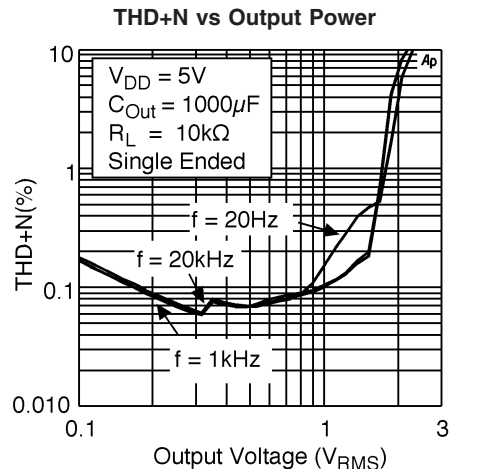

20013328

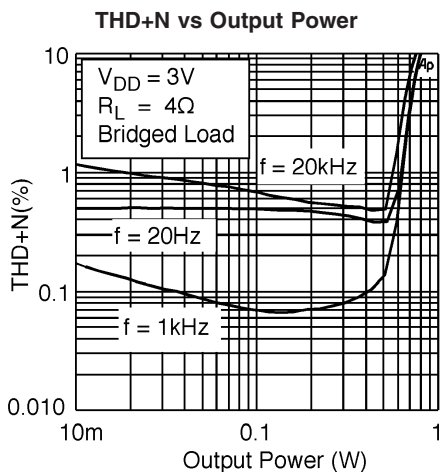

20013329

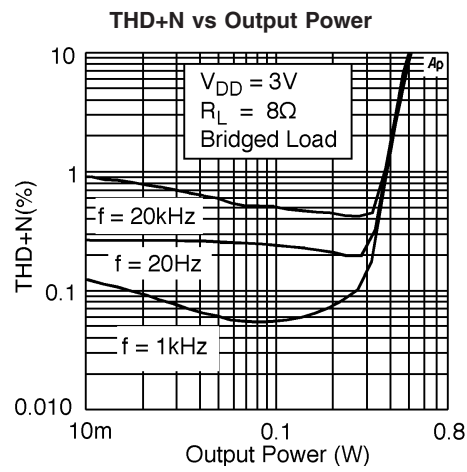

20013330

# Typical Performance Characteristics

## Non-MTE Specific Characteristics (Continued)

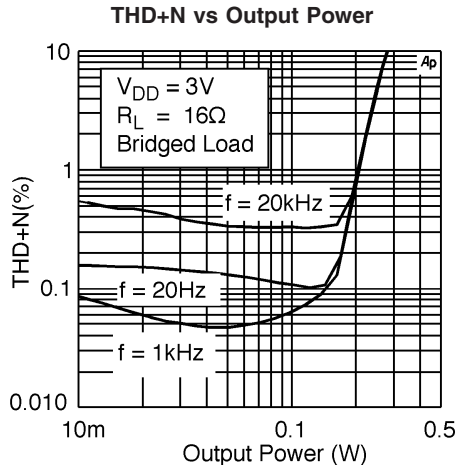

20013331

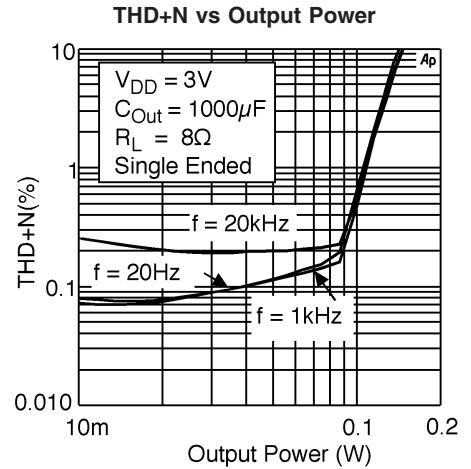

20013332

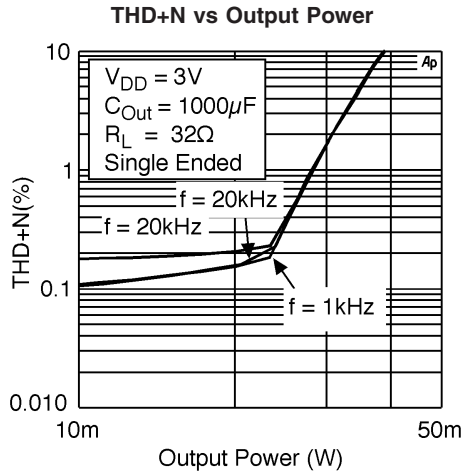

20013333

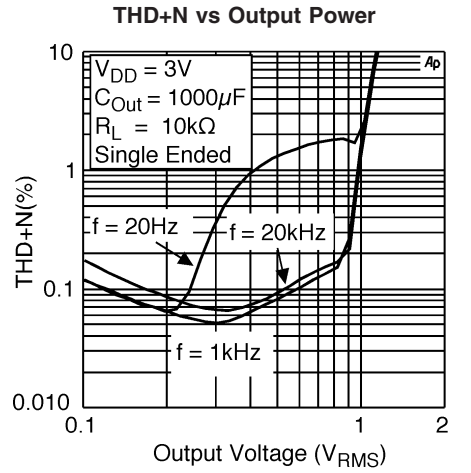

20013334

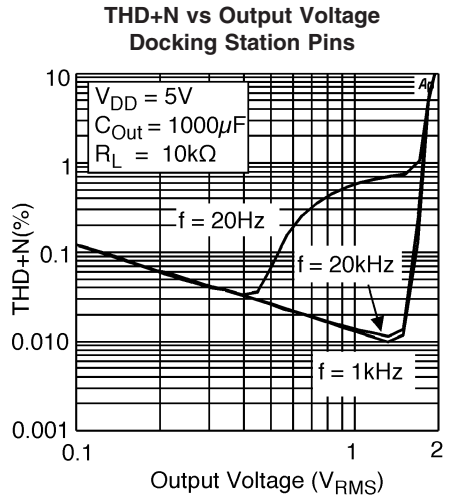

20013359

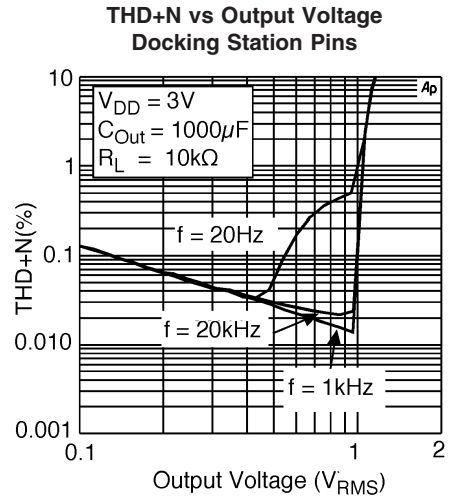

20013360

# Typical Performance Characteristics

**Output Power vs Load Resistance**

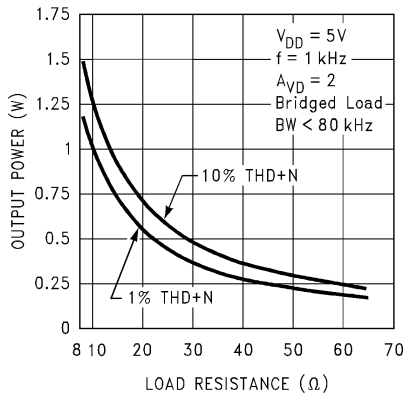

20013362

**Dropout Voltage**

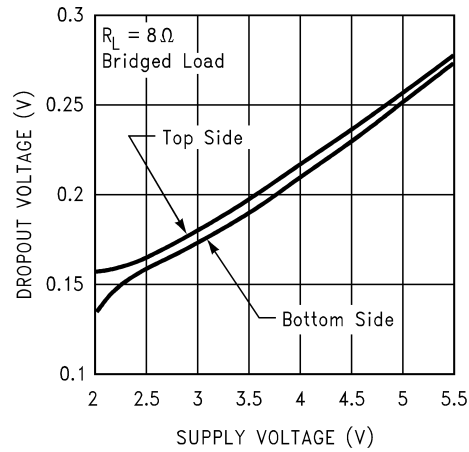

20013353

**Output Power vs Load Resistance**

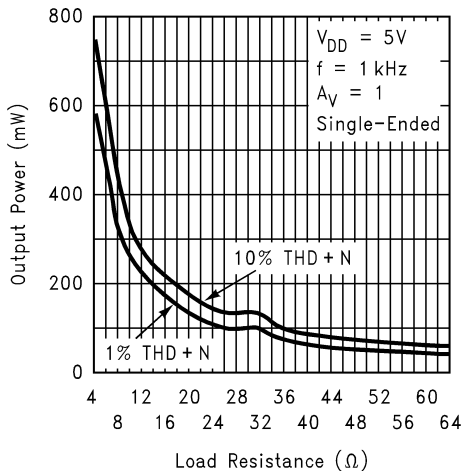

20013306

**Output Power vs Load Resistance**

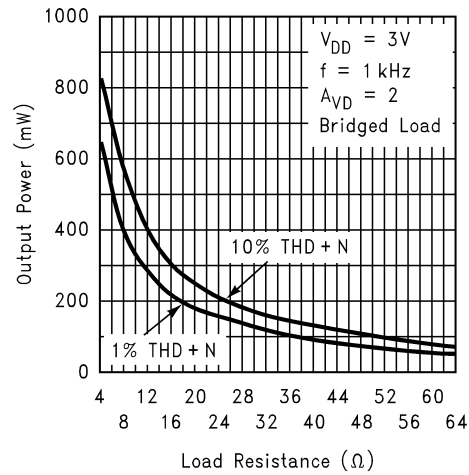

20013307

**Power Supply Rejection Ratio**

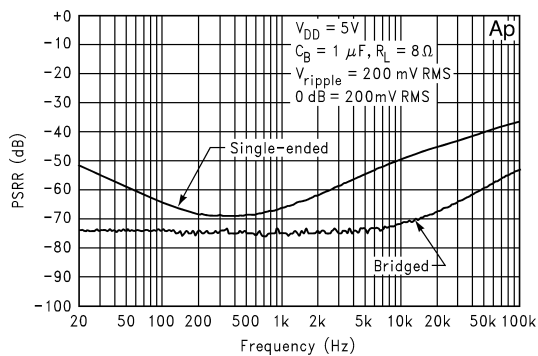

20013339

**Output Power vs Load Resistance**

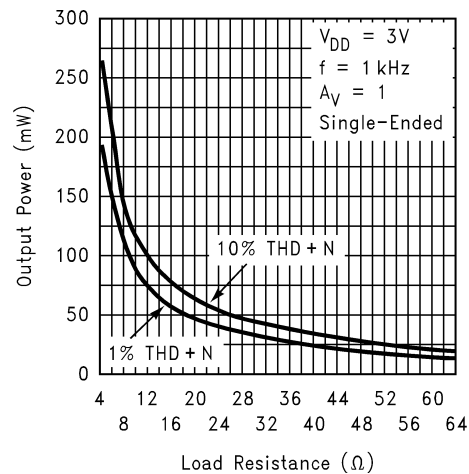

20013308

Typical Performance Characteristics (Continued)

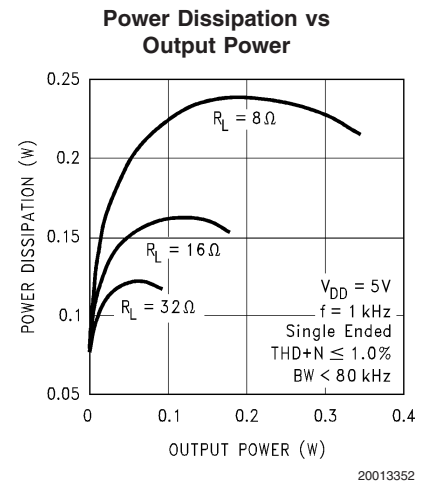
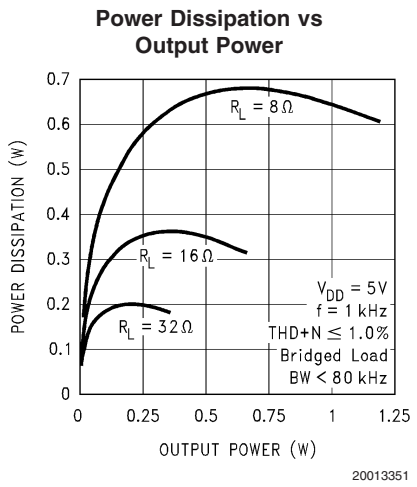
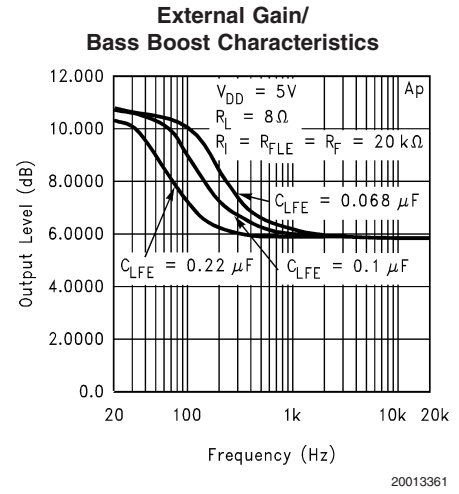
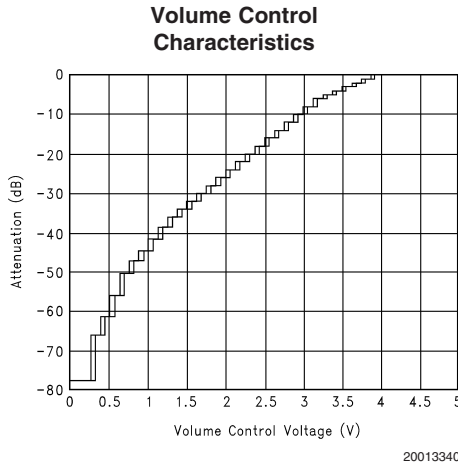
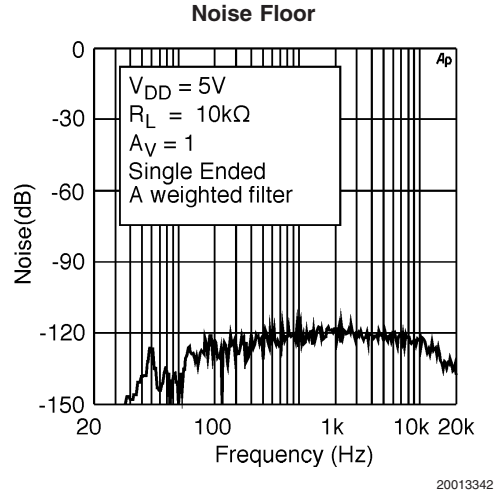
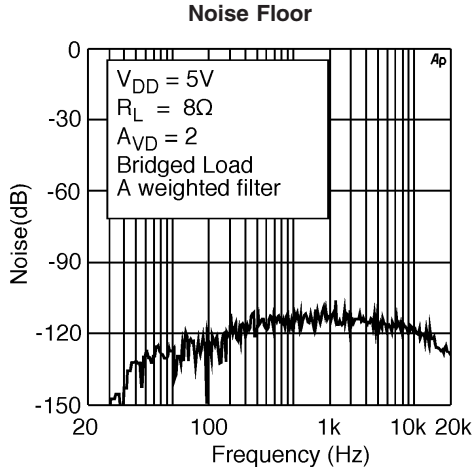

# Typical Performance Characteristics (Continued)

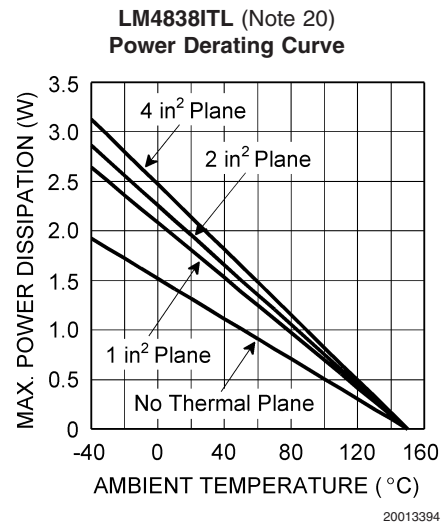
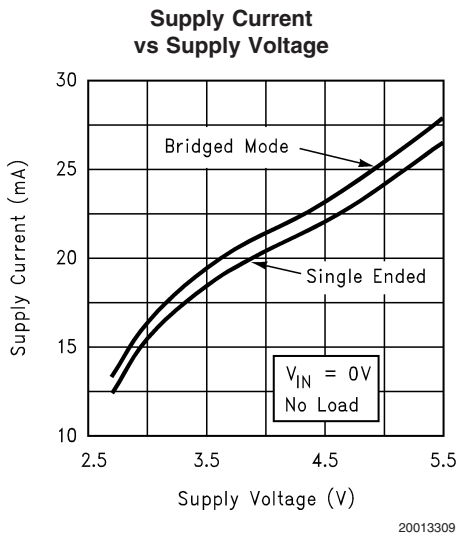
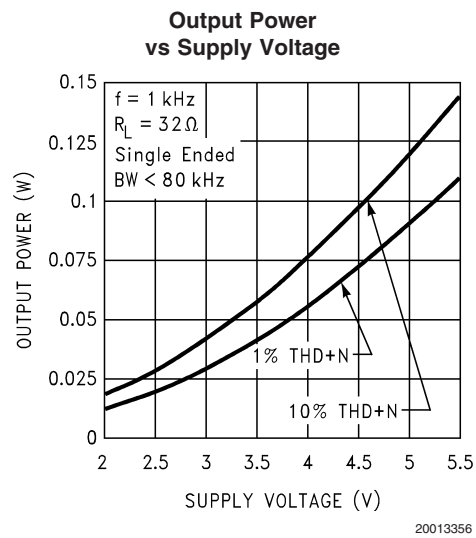
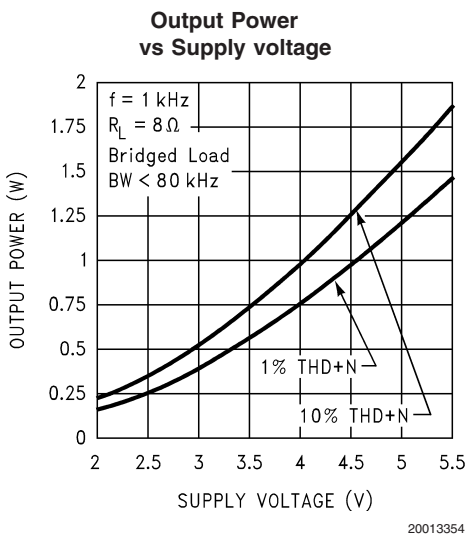
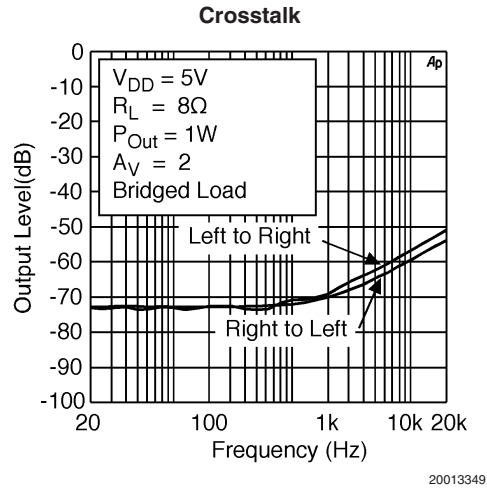
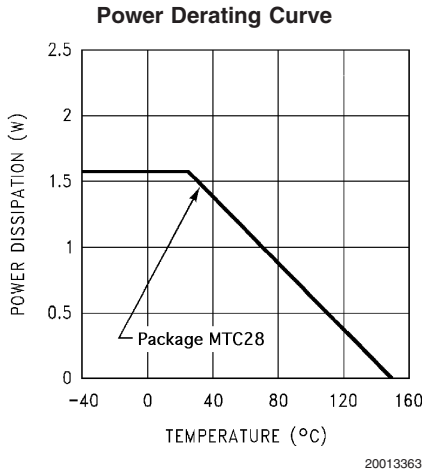

**Note 20:** These curves show the thermal dissipation of the LM4838ITL at different ambient temperatures with a thermal plane of size shown on an outside PCB layer using 1oz. copper.

## Application Information

### EXPOSED-DAP PACKAGE PCB MOUNTING CONSIDERATIONS

The LM4838's exposed-DAP (die attach paddle) packages (MTE, LQ) provide a low thermal resistance between the die and the PCB to which the part is mounted and soldered. This allows rapid heat transfer from the die to the surrounding PCB copper traces, ground plane and, finally, surrounding air. The result is a low voltage audio power amplifier that produces 2.1W at  $\leq 1\%$  THD with a  $4\Omega$  load. This high power is achieved through careful consideration of necessary thermal design. Failing to optimize thermal design may compromise the LM4838's high power performance and activate unwanted, though necessary, thermal shutdown protection.

The MTE and LQ packages must have their exposed DAPs soldered to a grounded copper pad on the PCB. The DAP's PCB copper pad is connected to a large grounded plane of continuous unbroken copper. This plane forms a thermal mass heat sink and radiation area. Place the heat sink area on either outside plane in the case of a two-sided PCB, or on an inner layer of a board with more than two layers. Connect the DAP copper pad to the inner layer or backside copper heat sink area with  $32(4 \times 8)$  (MTE) or  $6(3 \times 2)$  (LQ) vias. The via diameter should be 0.012in–0.013in with a 1.27mm pitch. Ensure efficient thermal conductivity by plating-through and solder-filling the vias.

Best thermal performance is achieved with the largest practical copper heat sink area. If the heatsink and amplifier share the same PCB layer, a nominal  $2.5\text{in}^2$  (min) area is necessary for 5V operation with a  $4\Omega$  load. Heatsink areas not placed on the same PCB layer as the LM4838 MTE and LQ packages should be  $5\text{in}^2$  (min) for the same supply voltage and load resistance. The last two area recommendations apply for  $25^\circ\text{C}$  ambient temperature. Increase the area to compensate for ambient temperatures above  $25^\circ\text{C}$ . In systems using cooling fans, the LM4838MTE can take advantage of forced air cooling. With an air flow rate of 450 linear-feet per minute and a  $2.5\text{in}^2$  exposed copper or  $5.0\text{in}^2$  inner layer copper plane heatsink, the LM4838MTE can continuously drive a  $3\Omega$  load to full power. The LM4838LQ achieves the same output power level without forced air cooling. In all circumstances and conditions, the junction temperature must be held below  $150^\circ\text{C}$  to prevent activating the LM4838's thermal shutdown protection. The LM4838's power de-rating curve in the **Typical Performance Characteristics** shows the maximum power dissipation versus temperature. Example PCB layouts for the exposed-DAP TSSOP and LQ packages are shown in the **Demonstration Board Layout** section. Further detailed and specific information concerning PCB layout, fabrication, and mounting an LQ (LLP) package is available in National Semiconductor's AN1187.

The micro SMD and GR packages (LM4838ITL and LM4838GR) thermals work in a similar way to the LQ and MTE packages in that a thermal plane increases the heat transfer from the die. The thermal plane can be any electrical potential but needs to be below the package to aid in the spreading the heat from the die out to surrounding PCB areas to reduce the thermal resistance of the micro SMD package. The thermal plane is most effective when placed on the top or first internal PCB layers. The traces connecting the bumps also contribute to spreading heat away from the die. The same recommendations for the size of the thermal

plane as given above apply for the ITL and GR packages, namely  $2.5\text{in}^2$  minimum for top layer thermal plane and  $5\text{in}^2$  minimum for internal or bottom layers.

### PCB LAYOUT AND SUPPLY REGULATION CONSIDERATIONS FOR DRIVING $3\Omega$ AND $4\Omega$ LOADS

Power dissipated by a load is a function of the voltage swing across the load and the load's impedance. As load impedance decreases, load dissipation becomes increasingly dependent on the interconnect (PCB trace and wire) resistance between the amplifier output pins and the load's connections. Residual trace resistance causes a voltage drop, which results in power dissipated in the trace and not in the load as desired. For example,  $0.1\Omega$  trace resistance reduces the output power dissipated by a  $4\Omega$  load from 2.1W to 2.0W. This problem of decreased load dissipation is exacerbated as load impedance decreases. Therefore, to maintain the highest load dissipation and widest output voltage swing, PCB traces that connect the output pins to a load must be as wide as possible.

Poor power supply regulation adversely affects maximum output power. A poorly regulated supply's output voltage decreases with increasing load current. Reduced supply voltage causes decreased headroom, output signal clipping, and reduced output power. Even with tightly regulated supplies, trace resistance creates the same effects as poor supply regulation. Therefore, making the power supply traces as wide as possible helps maintain full output voltage swing.

### BRIDGE CONFIGURATION EXPLANATION

As shown in *Figure 2*, the LM4838 output stage consists of two pairs of operational amplifiers, forming a two-channel (channel A and channel B) stereo amplifier. (Though the following discusses channel A, it applies equally to channel B.)

*Figure 2* shows that the first amplifier's negative (-) output serves as the second amplifier's input. This results in both amplifiers producing signals identical in magnitude, but  $180^\circ$  out of phase. Taking advantage of this phase difference, a load is placed between -OUTA and +OUTA and driven differentially (commonly referred to as "bridge mode"). This results in a differential gain of

$$A_{VD} = 2 * (R_f/R_i) \quad (1)$$

Bridge mode amplifiers are different from single-ended amplifiers that drive loads connected between a single amplifier's output and ground. For a given supply voltage, bridge mode has a distinct advantage over the single-ended configuration: **its differential output doubles the voltage swing across the load.** This produces four times the output power when compared to a single-ended amplifier under the same conditions. This increase in attainable output power assumes that the amplifier is not current limited or that the output signal is not clipped. To ensure minimum output signal clipping when choosing an amplifier's closed-loop gain, refer to the **Audio Power Amplifier Design** section.

Another advantage of the differential bridge output is no net DC voltage across the load. This is accomplished by biasing channel A's and channel B's outputs at half-supply. This eliminates the coupling capacitor that single supply, single-ended amplifiers require. Eliminating an output coupling capacitor in a single-ended configuration forces a single-supply



## Application Information (Continued)

amplifier's half-supply bias voltage across the load. This increases internal IC power dissipation and may permanently damage loads such as speakers.

### POWER DISSIPATION

Power dissipation is a major concern when designing a successful single-ended or bridged amplifier. Equation (2) states the maximum power dissipation point for a single-ended amplifier operating at a given supply voltage and driving a specified output load.

$$P_{\text{DMAX}} = (V_{\text{DD}})^2 / (2\pi^2 R_L) \quad \text{Single-Ended} \quad (2)$$

However, a direct consequence of the increased power delivered to the load by a bridge amplifier is higher internal power dissipation for the same conditions.

The LM4838 has two operational amplifiers per channel. The maximum internal power dissipation per channel operating in the bridge mode is four times that of a single-ended amplifier. From Equation (3), assuming a 5V power supply and a 4Ω load, the maximum single channel power dissipation is 1.27W or 2.54W for stereo operation.

$$P_{\text{DMAX}} = 4 * (V_{\text{DD}})^2 / (2\pi^2 R_L) \quad \text{Bridge Mode} \quad (3)$$

The LM4838's power dissipation is twice that given by Equation (2) or Equation (3) when operating in the single-ended mode or bridge mode, respectively. Twice the maximum power dissipation point given by Equation (3) must not exceed the power dissipation given by Equation (4):

$$P_{\text{DMAX}}' = (T_{\text{JMAX}} - T_A) / \theta_{\text{JA}} \quad (4)$$

The LM4838's  $T_{\text{JMAX}} = 150^\circ\text{C}$ . In the LQ package soldered to a DAP pad that expands to a copper area of  $5\text{in}^2$  on a PCB, the LM4838's  $\theta_{\text{JA}}$  is  $20^\circ\text{C/W}$ . In the MTE package soldered to a DAP pad that expands to a copper area of  $2\text{in}^2$  on a PCB, the LM4838MTE's  $\theta_{\text{JA}}$  is  $41^\circ\text{C/W}$ . For the LM4838MT package,  $\theta_{\text{JA}} = 80^\circ\text{C/W}$ . At any given ambient temperature  $T_A$ , use Equation (4) to find the maximum internal power dissipation supported by the IC packaging. Rearranging Equation (4) and substituting  $P_{\text{DMAX}}$  for  $P_{\text{DMAX}}'$  results in Equation (5). This equation gives the maximum ambient temperature that still allows maximum stereo power dissipation without violating the LM4838's maximum junction temperature.

$$T_A = T_{\text{JMAX}} - 2 * P_{\text{DMAX}} \theta_{\text{JA}} \quad (5)$$

For a typical application with a 5V power supply and an 4Ω load, the maximum ambient temperature that allows maximum stereo power dissipation without exceeding the maximum junction temperature is approximately  $99^\circ\text{C}$  for the LQ package and  $45^\circ\text{C}$  for the MTE package.

$$T_{\text{JMAX}} = P_{\text{DMAX}} \theta_{\text{JA}} + T_A \quad (6)$$

Equation (6) gives the maximum junction temperature  $T_{\text{JMAX}}$ . If the result violates the LM4838's  $150^\circ\text{C}$   $T_{\text{JMAX}}$ , reduce the maximum junction temperature by reducing the

power supply voltage or increasing the load resistance. Further allowance should be made for increased ambient temperatures.

The above examples assume that a device is a surface mount part operating around the maximum power dissipation point. Since internal power dissipation is a function of output power, higher ambient temperatures are allowed as output power or duty cycle decreases.

If the result of Equation (2) is greater than that of Equation (3), then decrease the supply voltage, increase the load impedance, or reduce the ambient temperature. If these measures are insufficient, a heat sink can be added to reduce  $\theta_{\text{JA}}$ . The heat sink can be created using additional copper area around the package, with connections to the ground pin(s), supply pin and amplifier output pins. External, solder attached SMT heatsinks such as the Thermalloy 7106D can also improve power dissipation. When adding a heat sink, the  $\theta_{\text{JA}}$  is the sum of  $\theta_{\text{JC}}$ ,  $\theta_{\text{CS}}$ , and  $\theta_{\text{SA}}$ . ( $\theta_{\text{JC}}$  is the junction-to-case thermal impedance,  $\theta_{\text{CS}}$  is the case-to-sink thermal impedance, and  $\theta_{\text{SA}}$  is the sink-to-ambient thermal impedance.) Refer to the **Typical Performance Characteristics** curves for power dissipation information at lower output power levels.

### POWER SUPPLY BYPASSING

As with any power amplifier, proper supply bypassing is critical for low noise performance and high power supply rejection. Applications that employ a 5V regulator typically use a 10 μF in parallel with a 0.1 μF filter capacitor to stabilize the regulator's output, reduce noise on the supply line, and improve the supply's transient response. However, their presence does not eliminate the need for a local 1.0μF tantalum bypass capacitance connected between the LM4838's supply pins and ground. Do not substitute a ceramic capacitor for the tantalum. Doing so may cause oscillation. Keep the length of leads and traces that connect capacitors between the LM4838's power supply pin and ground as short as possible. Connecting a 1μF capacitor,  $C_B$ , between the BYPASS pin and ground improves the internal bias voltage's stability and the amplifier's PSRR. The PSRR improvements increase as the BYPASS pin capacitor value increases. Too large a capacitor, however, increases turn-on time and can compromise the amplifier's click and pop performance. The selection of bypass capacitor values, especially  $C_B$ , depends on desired PSRR requirements, click and pop performance (as explained in the following section, **Selecting Proper External Components**), system cost, and size constraints.

### SELECTING PROPER EXTERNAL COMPONENTS

Optimizing the LM4838's performance requires properly selecting external components. Though the LM4838 operates well when using external components with wide tolerances, best performance is achieved by optimizing component values.

The LM4838 is unity-gain stable, giving a designer maximum design flexibility. The gain should be set to no more than a given application requires. This allows the amplifier to achieve minimum THD+N and maximum signal-to-noise ratio. These parameters are compromised as the closed-loop gain increases. However, low gain circuits demand input signals with greater voltage swings to achieve maximum output power. Fortunately, many signal sources such as audio CODECs have outputs of  $1V_{\text{RMS}}$  ( $2.83V_{\text{P-P}}$ ). Please refer to the **Audio Power Amplifier Design** section for more information on selecting the proper gain.

## Application Information (Continued)

### INPUT CAPACITOR VALUE SELECTION

Amplifying the lowest audio frequencies requires a high value input coupling capacitor (0.33 $\mu$ F in *Figure 2*), but high value capacitors can be expensive and may compromise space efficiency in portable designs. In many cases, however, the speakers used in portable systems, whether internal or external, have little ability to reproduce signals below 150 Hz. Applications using speakers with this limited frequency response reap little improvement by using a large input capacitor.

Besides effecting system cost and size, the input coupling capacitor has an affect on the LM4838's click and pop performance. When the supply voltage is first applied, a transient (pop) is created as the charge on the input capacitor changes from zero to a quiescent state. The magnitude of the pop is directly proportional to the input capacitor's size. Higher value capacitors need more time to reach a quiescent DC voltage (usually  $V_{DD}/2$ ) when charged with a fixed current. The amplifier's output charges the input capacitor through the feedback resistor,  $R_f$ . Thus, pops can be minimized by selecting an input capacitor value that is no higher than necessary to meet the desired -6dB frequency.

As shown in *Figure 2*, the input resistor ( $R_{IR}$ ,  $R_{IL} = 20k$ ) ( and the input capacitor ( $C_{IR}$ ,  $C_{IL} = 0.33\mu$ F) produce a -6dB high pass filter cutoff frequency that is found using Equation (7).

$$f_{-6\text{ dB}} = \frac{1}{2\pi R_{IN} C_1} \quad (7)$$

As an example when using a speaker with a low frequency limit of 150Hz, the input coupling capacitor, using Equation (7), is 0.053 $\mu$ F. The 0.33 $\mu$ F input coupling capacitor shown in *Figure 2* allows the LM4838 to drive a high efficiency, full range speaker whose response extends below 30Hz.

### OPTIMIZING CLICK AND POP REDUCTION PERFORMANCE

The LM4838 contains circuitry that minimizes turn-on and shutdown transients or "clicks and pops". For this discussion, turn-on refers to either applying the power supply voltage or when the shutdown mode is deactivated. While the power supply is ramping to its final value, the LM4838's internal amplifiers are configured as unity gain buffers. An internal current source changes the voltage of the BYPASS pin in a controlled, linear manner. Ideally, the input and outputs track the voltage applied to the BYPASS pin. The gain of the internal amplifiers remains unity until the voltage on the BYPASS pin reaches  $1/2 V_{DD}$ . As soon as the voltage on the BYPASS pin is stable, the device becomes fully operational. Although the BYPASS pin current cannot be modified, changing the size of  $C_B$  alters the device's turn-on time and the magnitude of "clicks and pops". Increasing the value of  $C_B$  reduces the magnitude of turn-on pops. However, this presents a tradeoff: as the size of  $C_B$  increases, the turn-on time increases. There is a linear relationship between the size of  $C_B$  and the turn-on time. Here are some typical turn-on times for various values of  $C_B$ :

$C_B$	$T_{ON}$
0.01 $\mu$ F	2ms
0.1 $\mu$ F	20ms
0.22 $\mu$ F	44ms
0.47 $\mu$ F	94ms
1.0 $\mu$ F	200ms

### DOCKING STATION INTERFACE

Applications such as notebook computers can take advantage of a docking station to connect to external devices such as monitors or audio/visual equipment that sends or receives line level signals. The LM4838 has two outputs, Right Dock and Left Dock, which connect to outputs of the internal input amplifiers that drive the volume control inputs. These input amplifiers can drive loads of  $>1k\Omega$  (such as powered speakers) with a rail-to-rail signal. Since the output signal present on the RIGHT DOCK and LEFT DOCK pins is biased to  $V_{DD}/2$ , coupling capacitors should be connected in series with the load when using these outputs. Typical values for the output coupling capacitors are 0.33 $\mu$ F to 1.0 $\mu$ F. If polarized coupling capacitors are used, connect their "+" terminals to the respective output pin, see *Figure 2*.

Since the DOCK outputs precede the internal volume control, the signal amplitude will be equal to the input signal's magnitude and cannot be adjusted. However, the input amplifier's closed-loop gain can be adjusted using external resistors. These 20k resistors ( $R_{FR}$ ,  $R_{FL}$ ) are shown in *Figure 2* and they set each input amplifier's gain to -1. Use Equation 7 to determine the input and feedback resistor values for a desired gain.

$$-A_{VR} = R_{FR}/R_{IR} \text{ and } -A_{VL} = R_{FL}/R_{IL} \quad (8)$$

Adjusting the input amplifier's gain sets the minimum gain for that channel. Although the single ended output of the Bridge Output Amplifiers can be used to drive line level outputs, it is recommended that the R & L Dock Outputs simpler signal path be used for better performance.

### BEEP DETECT FUNCTION

Computers and notebooks produce a system "beep" signal that drives a small speaker. The speaker's auditory output signifies that the system requires user attention or input. To accommodate this system alert signal, the LM4838's beep input pin is a mono input that accepts the beep signal. Internal level detection circuitry at this input monitors the beep signal's magnitude. When a signal level greater than  $V_{DD}/2$  is detected on the BEEP IN pin, the bridge output amplifiers are enabled. The beep signal is amplified and applied to the load connected to the output amplifiers. A valid beep signal will be applied to the load even when MUTE is active. Use the input resistors connected between the BEEP IN pin and the stereo input pins to accommodate different beep signal amplitudes. These resistors ( $R_{BEEP}$ ) are shown as 200k $\Omega$  devices in *Figure 2*. Use higher value resistors to reduce the gain applied to the beep signal. The resistors must be used to pass the beep signal to the stereo inputs. The BEEP IN pin is used only to detect the beep signal's magnitude: it does not pass the signal to the output amplifiers. The LM4838's shutdown mode must be deactivated before a system alert signal is applied to BEEP IN pin.

## Application Information (Continued)

### MICRO-POWER SHUTDOWN

The voltage applied to the SHUTDOWN pin controls the LM4838's shutdown function. Activate micro-power shutdown by applying  $V_{DD}$  to the SHUTDOWN pin. When active, the LM4838's micro-power shutdown feature turns off the amplifier's bias circuitry, reducing the supply current. The logic threshold is typically  $V_{DD}/2$ . The low 0.7  $\mu\text{A}$  typical shutdown current is achieved by applying a voltage that is as near as  $V_{DD}$  as possible to the SHUTDOWN pin. A voltage that is less than  $V_{DD}$  may increase the shutdown current.

There are a few ways to control the micro-power shutdown. These include using a single-pole, single-throw switch, a microprocessor, or a microcontroller. When using a switch, connect an external 10k $\Omega$  pull-up resistor between the SHUTDOWN pin and  $V_{DD}$ . Connect the switch between the SHUTDOWN pin and ground. Select normal amplifier operation by closing the switch. Opening the switch connects the SHUTDOWN pin to  $V_{DD}$  through the pull-up resistor, activating micro-power shutdown. The switch and resistor guarantee that the SHUTDOWN pin will not float. This prevents unwanted state changes. In a system with a microprocessor or a microcontroller, use a digital output to apply the control voltage to the SHUTDOWN pin. Driving the SHUTDOWN pin with active circuitry eliminates the need for a pull up resistor.

### MODE FUNCTION

The LM4838's MODE function has 2 states controlled by the voltage applied to the MODE pin. Mode 0, selected by applying 0V to the MODE pin, forces the LM4838 to effectively function as a "line-out," unity-gain amplifier. Mode 1, which uses the internal DC controlled volume control is selected by applying  $V_{DD}$  to the MODE pin. This mode sets the amplifier's gain according to the DC voltage applied to the DC VOL CONTROL pin. Unanticipated gain behavior can be prevented by connecting the MODE pin to  $V_{DD}$  or ground. Note: Do not let the mode pin float.

### MUTE FUNCTION

The LM4838 mutes the amplifier and DOCK outputs when  $V_{DD}$  is applied to the MUTE pin. Even while muted, the LM4838 will amplify a system alert (beep) signal whose magnitude satisfies the BEEP DETECT circuitry. Applying 0V to the MUTE pin returns the LM4838 to normal, unmuted operation. Prevent unanticipated mute behavior by connecting the MUTE pin to  $V_{DD}$  or ground. Do not let the mute pin float.

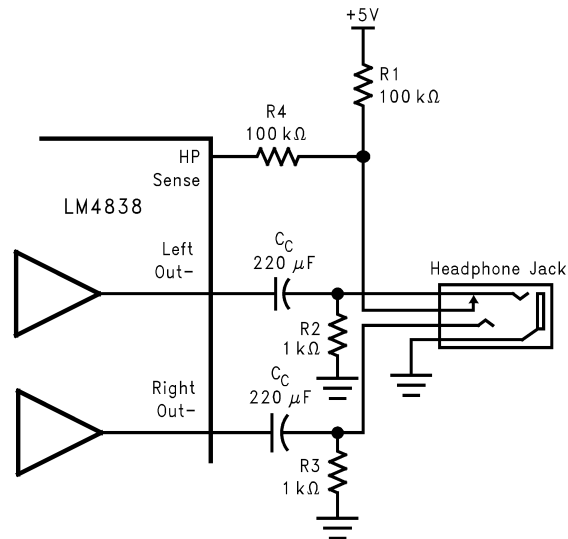

20013304

FIGURE 3. Headphone Sensing Circuit

### HP SENSE FUNCTION ( Head Phone In )

Applying a voltage between 4V and  $V_{DD}$  to the LM4838's HP-IN headphone control pin turns off the amps that drive the Left out "+" and Right out "+" pins. This action mutes a bridged-connected load. Quiescent current consumption is reduced when the IC is in this single-ended mode.

Figure 3 shows the implementation of the LM4838's headphone control function. With no headphones connected to the headphone jack, the R1-R2 voltage divider sets the voltage applied to the HP SENSE pin at approximately 50mV. This 50mV puts the LM4838 into bridged mode operation. The output coupling capacitor blocks the amplifier's half supply DC voltage, protecting the headphones.

The HP-IN threshold is set at 4V. While the LM4838 operates in bridged mode, the DC potential across the load is essentially 0V. Therefore, even in an ideal situation, the output swing cannot cause a false single-ended trigger. Connecting headphones to the headphone jack disconnects the headphone jack contact pin from R2 and allows R1 to pull the HP Sense pin up to  $V_{DD}$  through R4. This enables the headphone function, turns off both of the "+" output amplifiers, and mutes the bridged speaker. The remaining single-ended amplifiers then drive the headphones, whose impedance is in parallel with resistors R2 and R3. These resistors have negligible effect on the LM4838's output drive capability since the typical impedance of headphones is 32 $\Omega$ .

Figure 3 also shows the suggested headphone jack electrical connections. The jack is designed to mate with a three-wire plug. The plug's tip and ring should each carry one of the two stereo output signals, whereas the sleeve should carry the ground return. A headphone jack with one control pin contact is sufficient to drive the HP-IN pin when connecting headphones.

A microprocessor or a switch can replace the headphone jack contact pin. When a microprocessor or switch applies a voltage greater than 4V to the HP-IN pin, a bridge-connected speaker is muted and the single ended output amplifiers 1A and 2A will drive a pair of headphones.

## Application Information (Continued)

### GAIN SELECT FUNCTION (Bass Boost)

The LM4838 features selectable gain, using either internal or external feedback resistors. Either set of feedback resistors set the gain of the output amplifiers. The voltage applied to the GAIN SELECT pin controls which gain is selected. Applying  $V_{DD}$  to the GAIN SELECT pin selects the external gain mode. Applying 0V to the GAIN SELECT pin selects the internally set unity gain.

In some cases a designer may want to improve the low frequency response of the bridged amplifier or incorporate a bass boost feature. This bass boost can be useful in systems where speakers are housed in small enclosures. A resistor,  $R_{LFE}$ , and a capacitor,  $C_{LFE}$ , in parallel, can be placed in series with the feedback resistor of the bridged amplifier as seen in Figure 4.

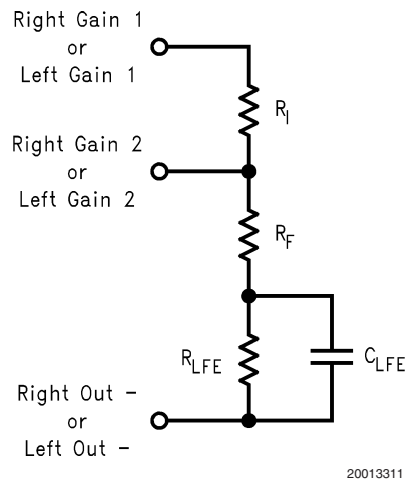

FIGURE 4. Low Frequency Enhancement

At low frequencies  $C_{LFE}$  is a virtual open circuit and at high frequencies, its nearly zero ohm impedance shorts  $R_{LFE}$ . The result is increased bridge-amplifier gain at low frequencies. The combination of  $R_{LFE}$  and  $C_{LFE}$  form a -6dB corner frequency at

$$f_c = 1/(2\pi R_{LFE} C_{LFE}) \quad (9)$$

The bridged-amplifier low frequency differential gain is:

$$A_{VD} = 2(R_f + R_{LFE}) / R_i \quad (10)$$

Using the component values shown in *Figure 1* ( $R_f = 20k\Omega$ ,  $R_{LFE} = 20k\Omega$ , and  $C_{LFE} = 0.068\mu F$ ), a first-order, -6dB pole is created at 120Hz. Assuming  $R_i = 20k\Omega$ , the low frequency differential gain is 4. The input ( $C_i$ ) and output ( $C_o$ ) capacitor values must be selected for a low frequency response that covers the range of frequencies affected by the desired bass-boost operation.

### DC VOLUME CONTROL

The LM4838 has an internal stereo volume control whose setting is a function of the DC voltage applied to the DC VOL CONTROL pin.

The LM4838 volume control consists of 31 steps that are individually selected by a variable DC voltage level on the volume control pin. The range of the steps, controlled by the DC voltage, are from 0dB - 78dB. Each gain step corresponds to a specific input voltage range, as shown in table 2.

To minimize the effect of noise on the volume control pin, which can affect the selected gain level, hysteresis has been implemented. The amount of hysteresis corresponds to half of the step width, as shown in Volume Control Characterization Graph (DS200133-40).

For highest accuracy, the voltage shown in the 'recommended voltage' column of the table is used to select a desired gain. This recommended voltage is exactly halfway between the two nearest transitions to the next highest or next lowest gain levels.

The gain levels are 1dB/step from 0dB to -6dB, 2dB/step from -6dB to -36dB, 3dB/step from -36dB to -47dB, 4dB/step from -47dB to -51dB, 5dB/step from -51dB to -66dB, and 12dB to the last step at -78dB.

**Application Information** (Continued)**VOLUME CONTROL TABLE ( Table 2 )**

Gain (dB)	Voltage Range (% of Vdd)			Voltage Range (Vdd = 5)			Voltage Range (Vdd = 3)		
	Low	High	Recommended	Low	High	Recommended	Low	High	Recommended
0	77.5%	100.00%	100.000%	3.875	5.000	5.000	2.325	3.000	3.000
-1	75.0%	78.5%	76.875%	3.750	3.938	3.844	2.250	2.363	2.306
-2	72.5%	76.25%	74.375%	3.625	3.813	3.719	2.175	2.288	2.231
-3	70.0%	73.75%	71.875%	3.500	3.688	3.594	2.100	2.213	2.156
-4	67.5%	71.25%	69.375%	3.375	3.563	3.469	2.025	2.138	2.081
-5	65.0%	68.75%	66.875%	3.250	3.438	3.344	1.950	2.063	2.006
-6	62.5%	66.25%	64.375%	3.125	3.313	3.219	1.875	1.988	1.931
-8	60.0%	63.75%	61.875%	3.000	3.188	3.094	1.800	1.913	1.856
-10	57.5%	61.25%	59.375%	2.875	3.063	2.969	1.725	1.838	1.781
-12	55.0%	58.75%	56.875%	2.750	2.938	2.844	1.650	1.763	1.706
-14	52.5%	56.25%	54.375%	2.625	2.813	2.719	1.575	1.688	1.631
-16	50.0%	53.75%	51.875%	2.500	2.688	2.594	1.500	1.613	1.556
-18	47.5%	51.25%	49.375%	2.375	2.563	2.469	1.425	1.538	1.481
-20	45.0%	48.75%	46.875%	2.250	2.438	2.344	1.350	1.463	1.406
-22	42.5%	46.25%	44.375%	2.125	2.313	2.219	1.275	1.388	1.331
-24	40.0%	43.75%	41.875%	2.000	2.188	2.094	1.200	1.313	1.256
-26	37.5%	41.25%	39.375%	1.875	2.063	1.969	1.125	1.238	1.181
-28	35.0%	38.75%	36.875%	1.750	1.938	1.844	1.050	1.163	1.106
-30	32.5%	36.25%	34.375%	1.625	1.813	1.719	0.975	1.088	1.031
-32	30.0%	33.75%	31.875%	1.500	1.688	1.594	0.900	1.013	0.956
-34	27.5%	31.25%	29.375%	1.375	1.563	1.469	0.825	0.937	0.881
-36	25.0%	28.75%	26.875%	1.250	1.438	1.344	0.750	0.862	0.806
-39	22.5%	26.25%	24.375%	1.125	1.313	1.219	0.675	0.787	0.731
-42	20.0%	23.75%	21.875%	1.000	1.188	1.094	0.600	0.712	0.656
-45	17.5%	21.25%	19.375%	0.875	1.063	0.969	0.525	0.637	0.581
-47	15.0%	18.75%	16.875%	0.750	0.937	0.844	0.450	0.562	0.506
-51	12.5%	16.25%	14.375%	0.625	0.812	0.719	0.375	0.487	0.431
-56	10.0%	13.75%	11.875%	0.500	0.687	0.594	0.300	0.412	0.356
-61	7.5%	11.25%	9.375%	0.375	0.562	0.469	0.225	0.337	0.281
-66	5.0%	8.75%	6.875%	0.250	0.437	0.344	0.150	0.262	0.206
-78	0.0%	6.25%	0.000%	0.000	0.312	0.000	0.000	0.187	0.000

## Application Information (Continued)

### AUDIO POWER AMPLIFIER DESIGN

#### Audio Amplifier Design: Driving 1W into an 8Ω Load

The following are the desired operational parameters:

Power Output:	1 W <sub>RMS</sub>
Load Impedance:	8Ω
Input Level:	1 V <sub>RMS</sub>
Input Impedance:	20 kΩ
Bandwidth:	100 Hz–20 kHz ± 0.25 dB

The design begins by specifying the minimum supply voltage necessary to obtain the specified output power. One way to find the minimum supply voltage is to use the Output Power vs Supply Voltage curve in the **Typical Performance Characteristics** section. Another way, using Equation (10), is to calculate the peak output voltage necessary to achieve the desired output power for a given load impedance. To account for the amplifier's dropout voltage, two additional voltages, based on the Dropout Voltage vs Supply Voltage in the **Typical Performance Characteristics** curves, must be added to the result obtained by Equation (10). The result is Equation (11).

$$V_{\text{outpeak}} = \sqrt{(2R_L P_O)} \quad (11)$$

$$V_{DD} \geq (V_{\text{OUTPEAK}} + (V_{\text{ODTOP}} + V_{\text{ODBOT}})) \quad (12)$$

The Output Power vs Supply Voltage graph for an 8Ω load indicates a minimum supply voltage of 4.6V. This is easily met by the commonly used 5V supply voltage. The additional voltage creates the benefit of headroom, allowing the LM4838 to produce peak output power in excess of 1W without clipping or other audible distortion. The choice of supply voltage must also not create a situation that violates of maximum power dissipation as explained above in the **Power Dissipation** section.

After satisfying the LM4838's power dissipation requirements, the minimum differential gain needed to achieve 1W dissipation in an 8Ω load is found using Equation (12).

$$A_{VD} \geq \sqrt{(P_O R_L)} / (V_{IN}) = V_{\text{orms}} / V_{\text{inrms}} \quad (13)$$

Thus, a minimum overall gain of 2.83 allows the LM4838's to reach full output swing and maintain low noise and THD+N performance.

The last step in this design example is setting the amplifier's –6dB frequency bandwidth. To achieve the desired ±0.25dB pass band magnitude variation limit, the low frequency response must extend to at least one-fifth the lower bandwidth limit and the high frequency response must extend to at least five times the upper bandwidth limit. The gain variation for both response limits is 0.17dB, well within the ±0.25dB desired limit. The results are an

$$f_L = 100\text{Hz}/5 = 20\text{Hz} \quad (14)$$

and an

$$f_H = 20\text{kHz} \times 5 = 100\text{kHz} \quad (15)$$

As mentioned in the **Selecting Proper External Components** section, R<sub>i</sub> (Right & Left) and C<sub>i</sub> (Right & Left) create a highpass filter that sets the amplifier's lower bandpass frequency limit. Find the input coupling capacitor's value using Equation (14).

$$C_i \geq 1/(2\pi R_i f_L) \quad (16)$$

The result is

$$1/(2\pi * 20\text{k}\Omega * 20\text{Hz}) = 0.397\mu\text{F} \quad (17)$$

Use a 0.39μF capacitor, the closest standard value.

The product of the desired high frequency cutoff (100kHz in this example) and the differential gain A<sub>VD</sub>, determines the upper passband response limit. With A<sub>VD</sub> = 3 and f<sub>H</sub> = 100kHz, the closed-loop gain bandwidth product (GBWP) is 300kHz. This is less than the LM4838's 3.5MHz GBWP. With this margin, the amplifier can be used in designs that require more differential gain while avoiding performance, restricting bandwidth limitations.

## Recommended Printed Circuit Board Layout

The following figures show the recommended PC board layouts that are optimized for the different package options of the LM4838 and associated external components. This circuit is designed for use with an external 5V supply and 4Ω speakers.

This circuit board is easy to use. Apply 5V and ground to the board's V<sub>DD</sub> and GND pads, respectively. Connect 4Ω speakers between the board's –OUTA and +OUTA and OUTB and +OUTB pads.

Recommended Printed Circuit Board Layout (Continued)

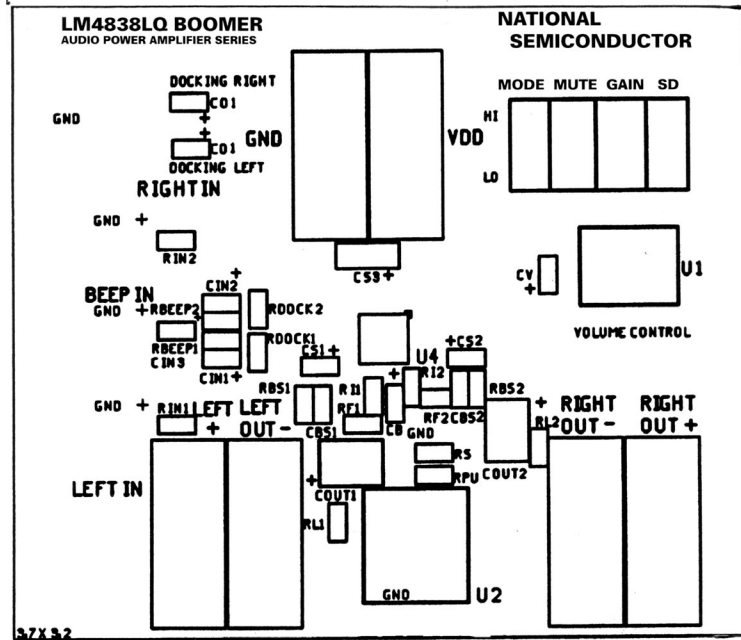

FIGURE 5. Recommended LQ PC Board Layout: Component-Side Silkscreen

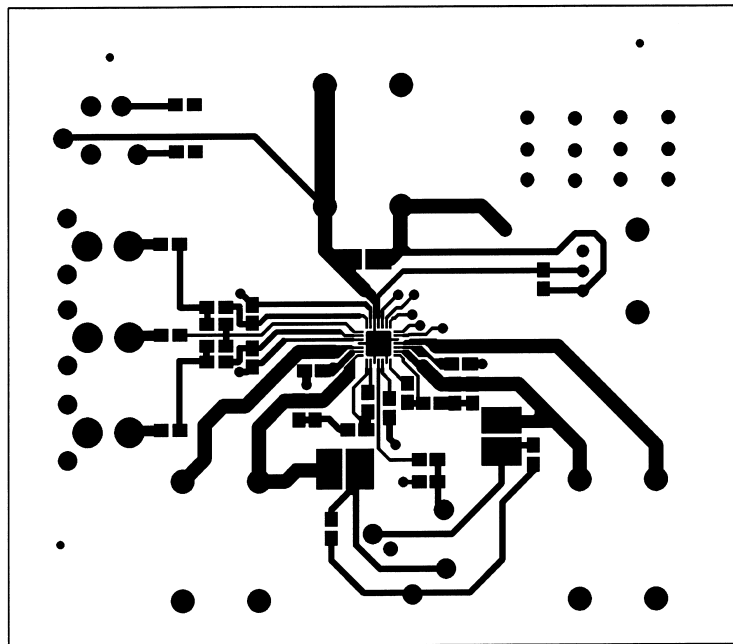
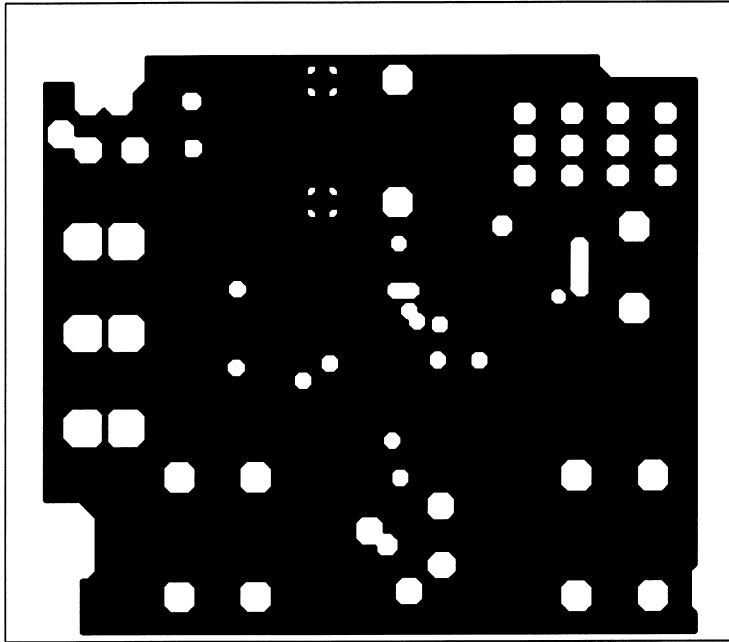

FIGURE 6. Recommended LQ PC Board Layout: Component-Side Layout

# Recommended Printed Circuit Board Layout (Continued)



20013379

**FIGURE 7. Recommended LQ PC Board Layout:  
Upper Inner-Layer Layout**

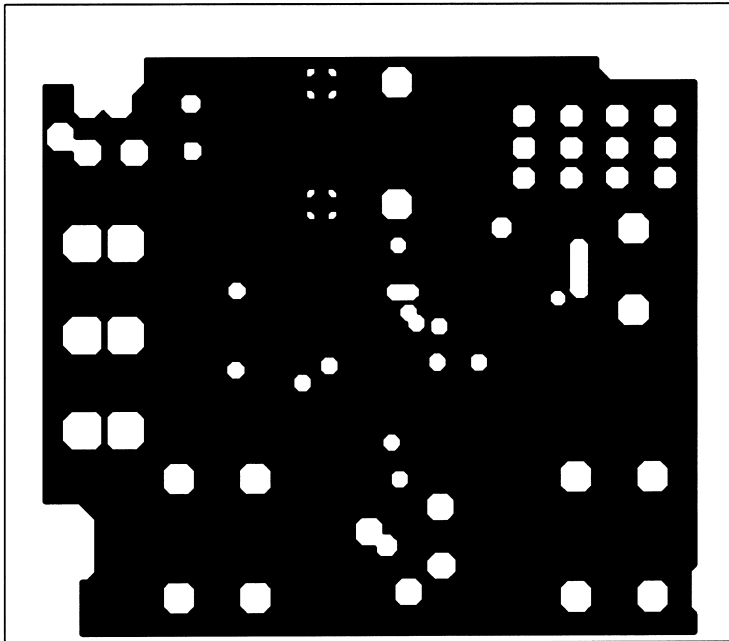

20013380

**FIGURE 8. Recommended LQ PC Board Layout:  
Lower Inner-Layer Layout**



# Recommended Printed Circuit Board Layout (Continued)

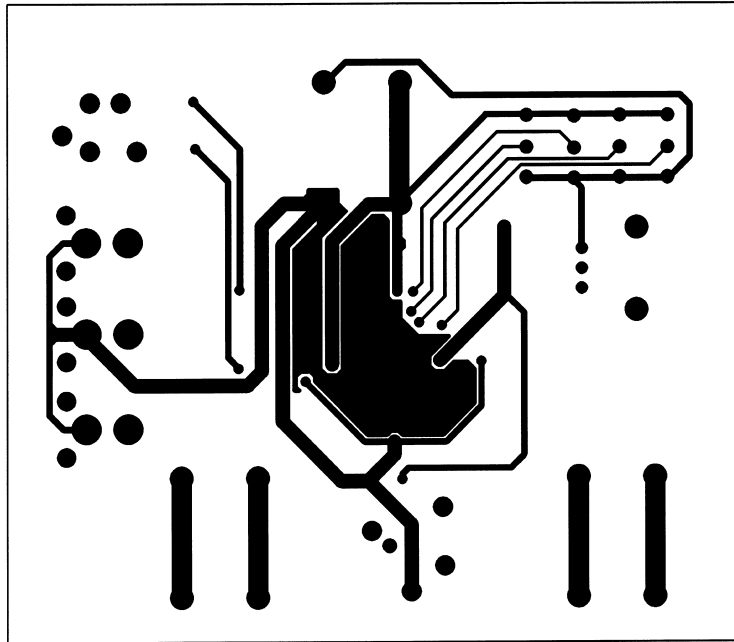

20013381

**FIGURE 9. Recommended LQ PC Board Layout:  
Bottom-Side Layout**

Analog Audio LM4838 LLP28 Eval Board  
 Assembly Part Number: 980011368-100  
 Revision: A1  
 Bill of Material

Item	Part Number	Part Description	Qty	Ref Designator	Remark
1	551011368-001	LM4838 Eval Board PCB etch 001	1		
10	482911368-001	LM4838 28L LLP	1	U4	
20	151911368-001	Cer Cap 0.068 $\mu$ F 50V 10% 1206	2	CBS1, CBS2	
25	152911368-001	Tant Cap 0.1 $\mu$ F 10V 10% Size = A 3216	3	CS1, CS2, CV	
26	152911368-002	Tant Cap 0.33 $\mu$ F 10V 10% Size = A 3216	3	Cin1, Cin2, Cin3	
27	152911368-003	Tant Cap 1 $\mu$ F 16V 10% Size = A 3216	3	CB, C01, C02	
28	152911368-004	Tant Cap 10 $\mu$ F 10V 10% Size = C 6032	1	CS3	
29	152911368-005	Tant Cap 220 $\mu$ F 16V 10% Size = D 7343	2	Cout1, Cout2	
30	472911368-001	Res 1.5K Ohm 1/8W 1% 1206	2	RL1, RL2	
31	472911368-002	Res 20k Ohm 1/8W 1% 1206	10	Rin1, Rin2, RF1, RF2 RI1, RI2, RBS1, RBS2 Rdock1, Rdock2	
32	472911368-003	Res 100k Ohm 1/8W 1% 1206	2	RS, RPU	
33	472911368-004	Res 200k Ohm 1/16W 1% 0603	2	Rbeep1, Rbeep2	
40	131911368-001	Stereo Headphone Jack W/ Switch	1	U2	Mouser # 161-3500
41	131911368-002	Slide Switch	4	Mode, Mute, Gain, SD	Mouser # 10SP003
42	131911368-003	Potentiometer	1	U1	Mouser # 317-290-100K
43	131911368-004	RCA Jack	3	RightIn, BeepIn, LeftIn	Mouser # 16PJ097
44	131911368-005	Banana Jack, Black	3	GND, Right Out-, Left Out-	Mouser # ME164-6219
45	131911368-006	Banana Jack, Red	3	Vdd, Right Out+, Left Out+	Mouser # ME164-6218

# LM4838 MT & MTE Demo Board Artwork

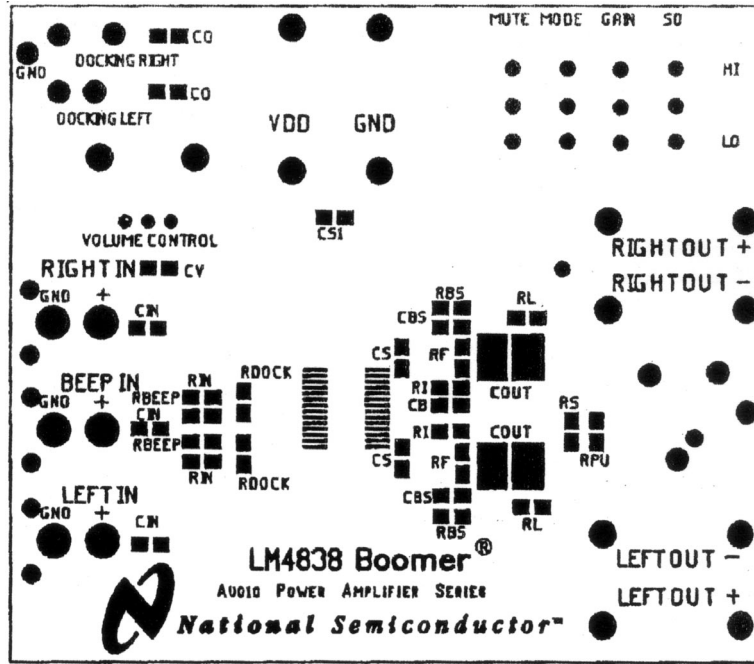

20013382

Top Layer SilkScreen

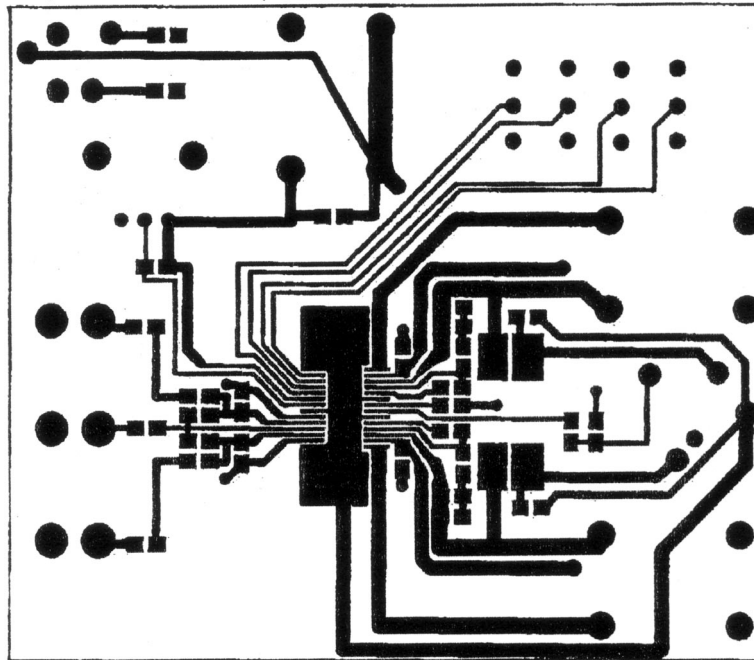

20013383

Top Layer TSSOP

# LM4838 MT & MTE Demo Board Artwork (Continued)

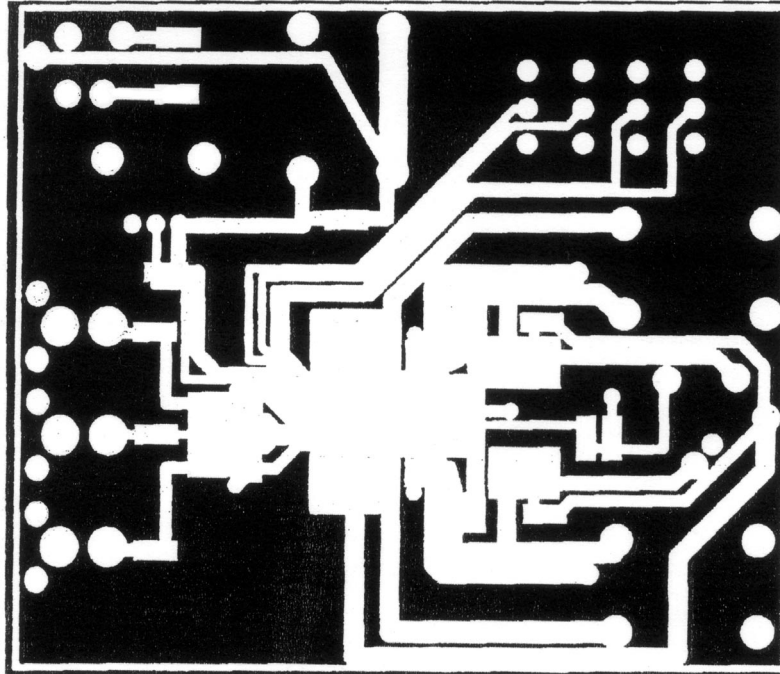

20013385

Inner Layer (2) LM4838MT/MTE

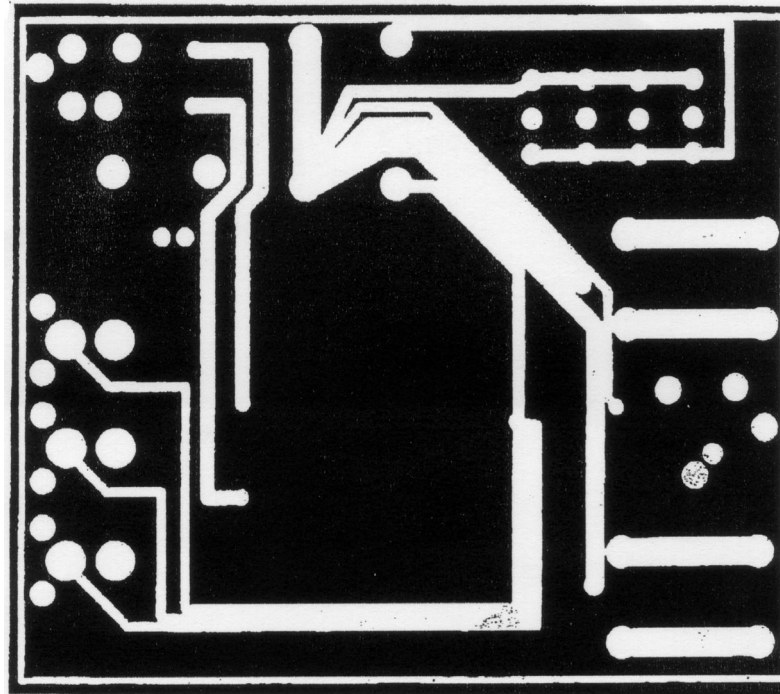

20013386

Inner Layer (3) LM4838MT/MTE

## LM4838 MT &amp; MTE Demo Board Artwork (Continued)

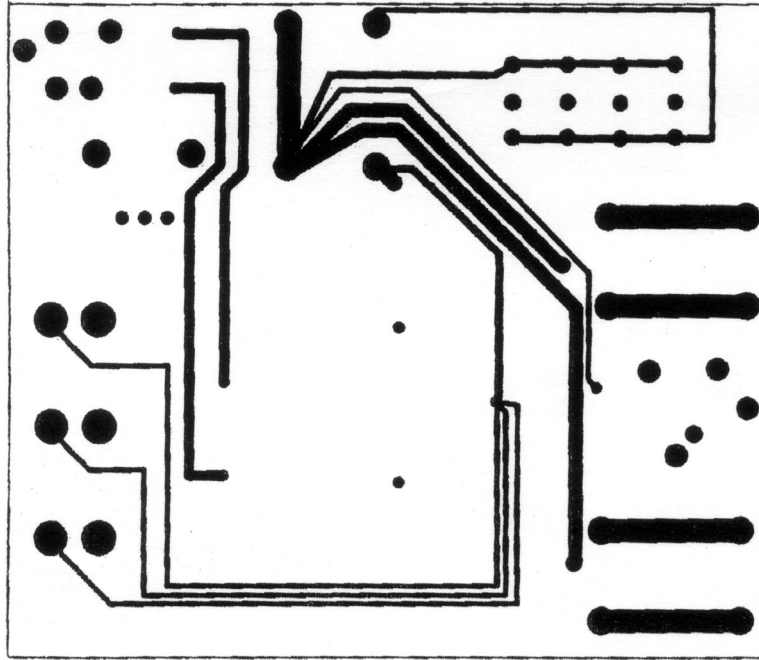

20013384

Bottom Layer TSSOP

Analog Audio LM4838 TSSOP Eval Board  
 Assembly Part Number: 980011373-100

Revision: A

## Bill of Material

Item	Part Number	Part Description	Qty	Ref Designator	Remark
1	551011373-001	LM4838 Eval Board PCB etch 001	1		
10	482911373-001	LM4838 TSSOP	1		
20	151911368-001	Cer Cap 0.068 $\mu$ F 50V 10% 1206	2	CBS	
25	152911368-001	Tant Cap 0.1 $\mu$ F 10V 10% Size = A 3216	3	CS, CS, CV	
26	152911368-002	Tant Cap 0.33 $\mu$ F 10V 10% Size = A 3216	3	CIN	
27	152911368-003	Tant Cap 1 $\mu$ F 16V 10% Size = A 3216	3	CB, CO1, CO2	
28	152911368-004	Tant Cap 10 $\mu$ F 10V 10% Size = C 6032	1	CS1	
29	152911368-005	Tant Cap 220 $\mu$ F 16V 10% Size = D 7343	2	CoutL, R	
30	472911368-001	Res 1.5K Ohm 1/8W 1% 1206	2	RL	
31	472911368-002	Res 20K Ohm 1/8W 1% 1206	10	RIN(4), RF(2), RDOCK(2), RBS(2)	
32	472911368-003	Res 100K Ohm 1/8W 1% 1206	2	RPU, RS	
33	472911368-004	Res 200K Ohm 1/16W 1% 0603	2	RBEEP	

**Analog Audio LM4838 TSSOP Eval Board**  
**Assembly Part Number: 980011373-100**  
**Revision: A**  
**Bill of Material (Continued)**

Item	Part Number	Part Description	Qty	Ref Designator	Remark
40	131911368-001	Stereo Headphone Jack W/ Switch	1		Mouser # 161-3500
41	131911368-002	Slide Switch	4	mute, mode, Gain, SD	Mouser # 10SP003
42	131911368-003	Potentiometer	1	Volume Control	Mouser # 317-2090-100K
43	131911368-004	RCA Jack	3	Right-In, Beep-In, Left-In	Mouser # 16PJ097
44	131911368-005	Banana Jack, Black	3		Mouser # ME164-6219
45	131911368-006	Banana Jack, Red	3		Mouser # ME164-6218

# LM4838 ITL Demo Board Artwork

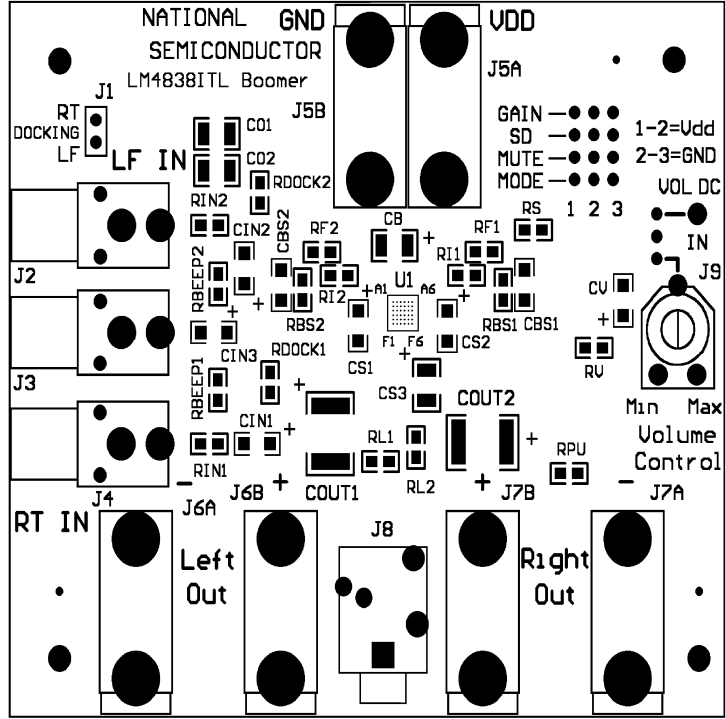

20013392

FIGURE 10. LM4838 micro SMD Silk Screen

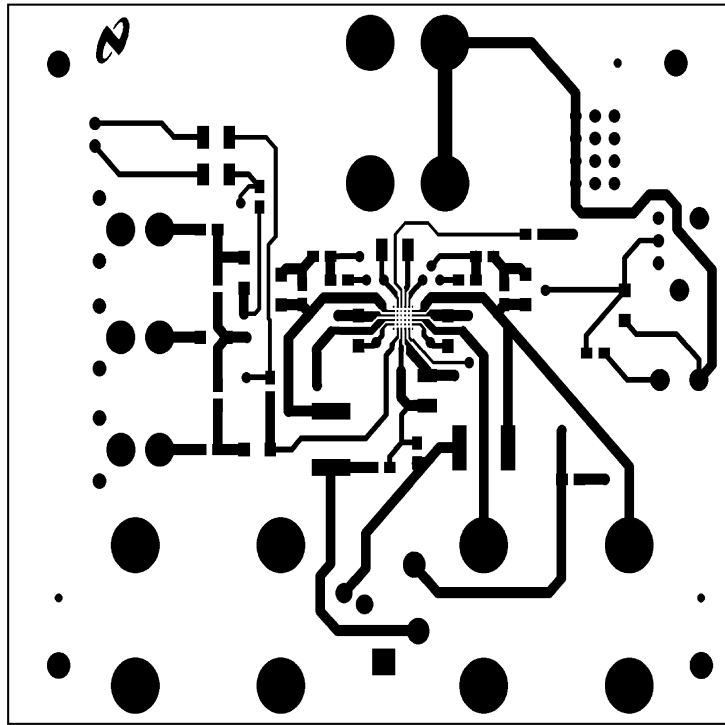

20013389

FIGURE 11. LM4838 micro SMD Top Layer

# LM4838 ITL Demo Board Artwork (Continued)

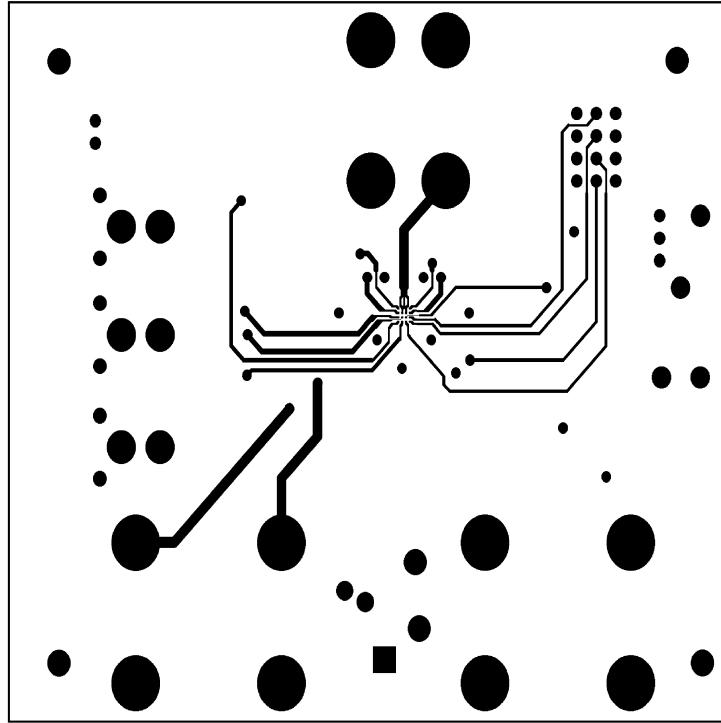

20013390

FIGURE 12. LM4838 micro SMD Upper Inner Layer

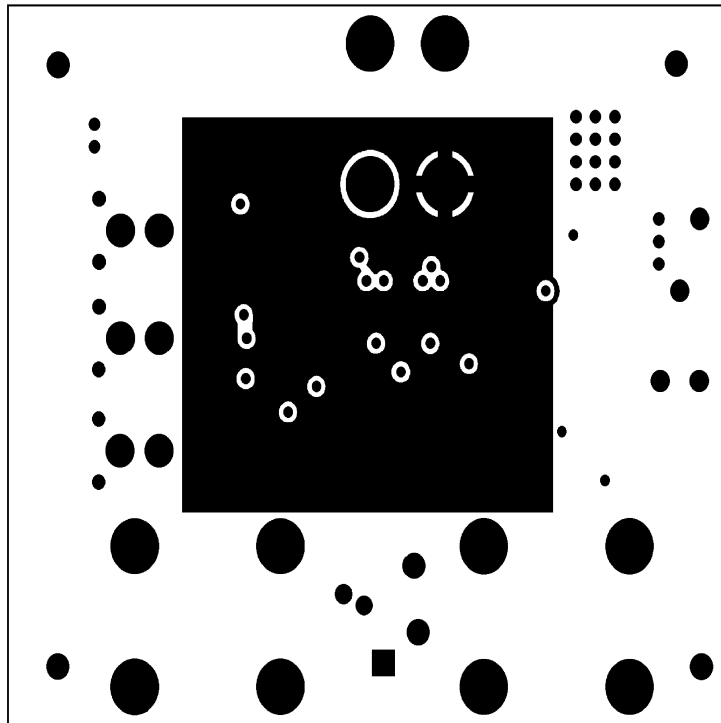

20013391

FIGURE 13. LM4838 micro SMD Lower Inner Layer



LM4838 ITL Demo Board Artwork (Continued)

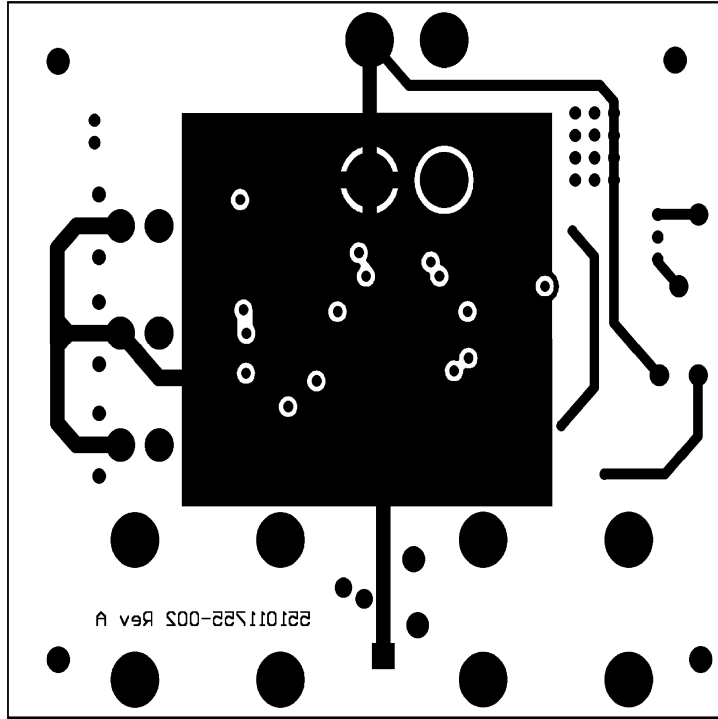

20013393

FIGURE 14. LM4838 micro SMD Bottom Layer

**Analog Audio LM4838 TLA36 Board  
Bill of Material**

Part Description $\mu\Omega$	Qty	Reference Designator
LM4838 TLA36 Evaluation Board PCB	1	P/N: 551011755 - 002 rev A
LM4838ITL	1	U1
Ceramic Capacitor 0.068 $\mu$ F 50V 10% Size = 1206	2	CBS1, CBS2
Tantalum Capacitor 0.1 $\mu$ F 10V 10% Size = 1206	3	CS1, CS2, CV
Tantalum Capacitor 0.33 $\mu$ F 10V 10% Size = 1206	3	CIN1, CIN2, CIN3
Tantalum Capacitor 1.0 $\mu$ F 16V 10% Size = 1210	4	CS3, CB, CO1, CO2
Tantalum Capacitor 220 $\mu$ F 16V 10% Size = 7343	2	COUT1, COUT2
Resistor 1.5k $\Omega$ 1/10W 1% Size = 0805	2	RL1, RL2
Resistor 20k $\Omega$ 1/10W 1% Size = 0805	10	RIN1, RIN2, RF1, RF2, RI1, RI2, RBS1, RBS2, RDOCK1, RDOCK2
Resistor 100k $\Omega$ 1/10W 1% Size = 0805	2	RS, RPU
Resistor 120k $\Omega$ 1/10W 1% Size = 0805	2	RBEEP1, RBEEP2
Resistor 1M $\Omega$ 1/10W 1% Size = 0805	1	RV
Jumper Header Vertical Mount 0.100" spacing	1	J1 (Docking RT LF)
RCA Jack PCB mount	3	J2 (LeftIn), J3 (Beep In), J4 (Right In)
Banana Jack, Black	3	J5B (GND), J6A (Right Out -), J7A (Left Out -)
Banana Jack, Red	3	J5A ( $V_{DD}$ ), J6B (Right Out +), J7B (Left Out +)
Stereo Headphone Jack W/Switch	1	J8
Single Turn Potentiometer 100k $\Omega$ 20%	1	J9
Jumper Header Vertical Mount 0.100" spacing 3x4	1	Mute, SD, Gain, Mode
Jumper Header Vertical Mount 0.100" spacing 1x3	1	DC IN

**Physical Dimensions** inches (millimeters) unless otherwise noted

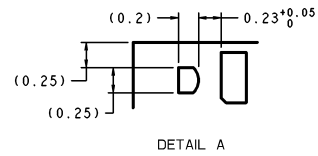
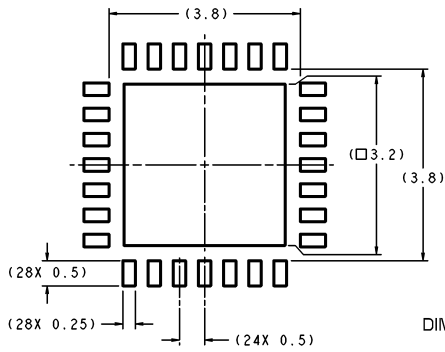

DIMENSIONS ARE IN MILLIMETERS

RECOMMENDED LAND PATTERN  
1:1 RATION WITH PKG SOLDER PADS

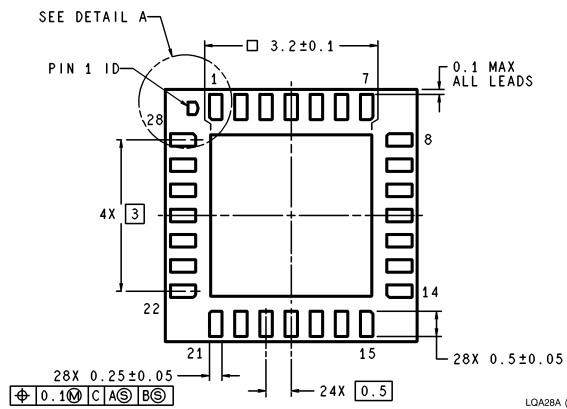
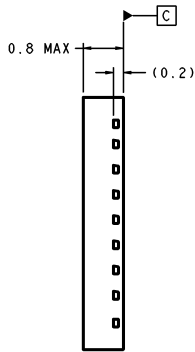
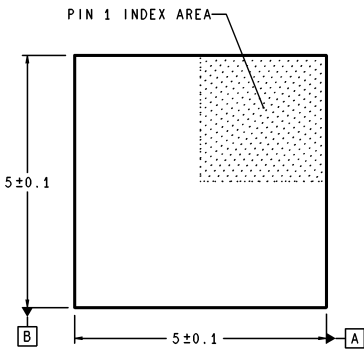

LQA28A (Rev B)

**LLP Package**  
**Order Number LM4838LQ**  
**NS Package Number LQA028AA For Exposed-DAP LLP**

**Physical Dimensions** inches (millimeters) unless otherwise noted (Continued)

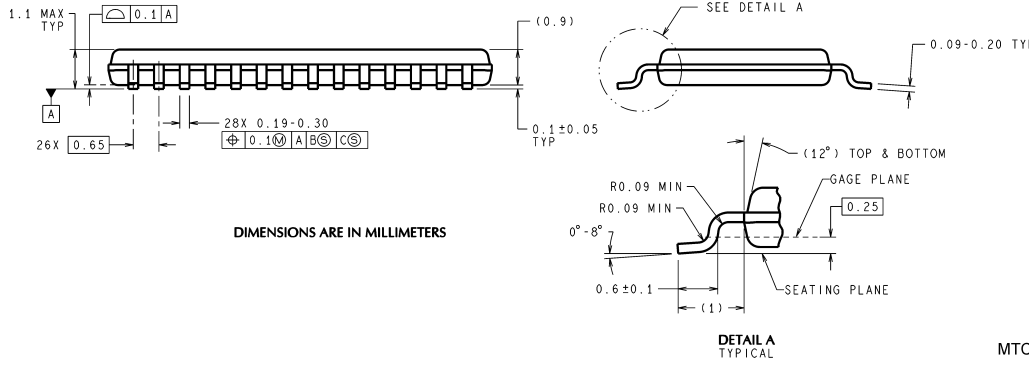
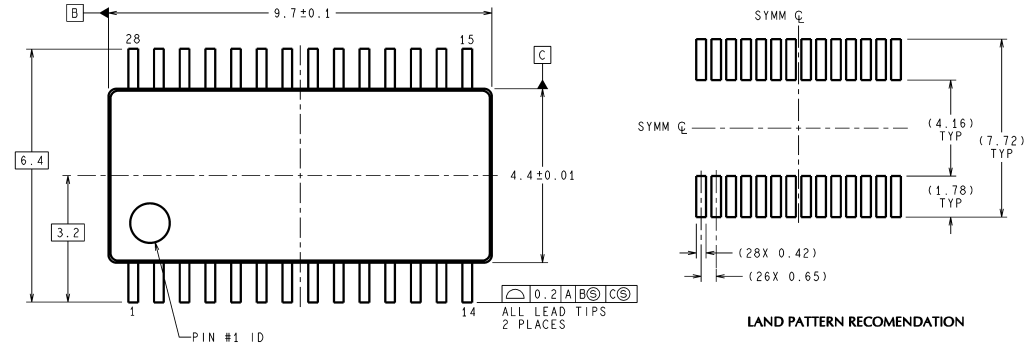

**TSSOP Package**  
**Order Number LM4838MT**  
**NS Package Number MTC28 for TSSOP**

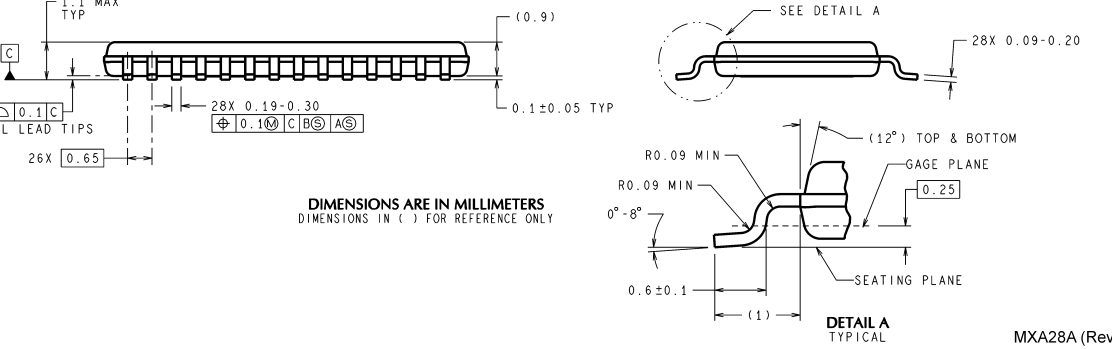
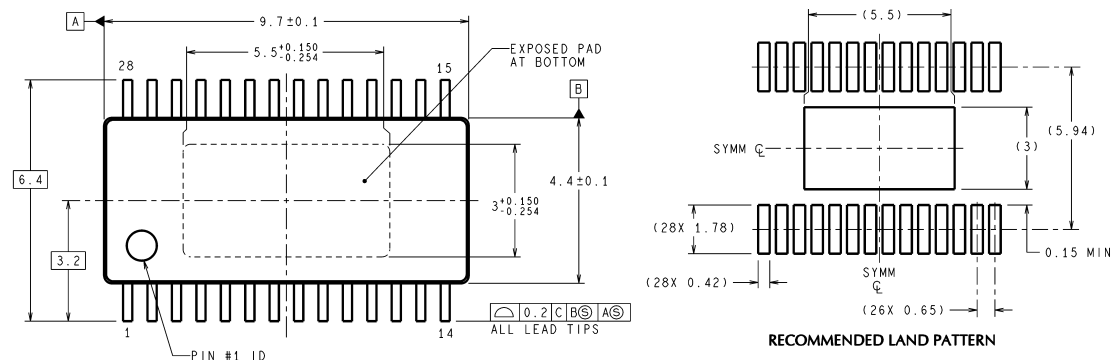

**Exposed-DAP TSSOP Package**  
**Order Number LM4838MTE**  
**NS Package Number MXA28A for Exposed-DAP TSSOP**

**Physical Dimensions** inches (millimeters) unless otherwise noted (Continued)

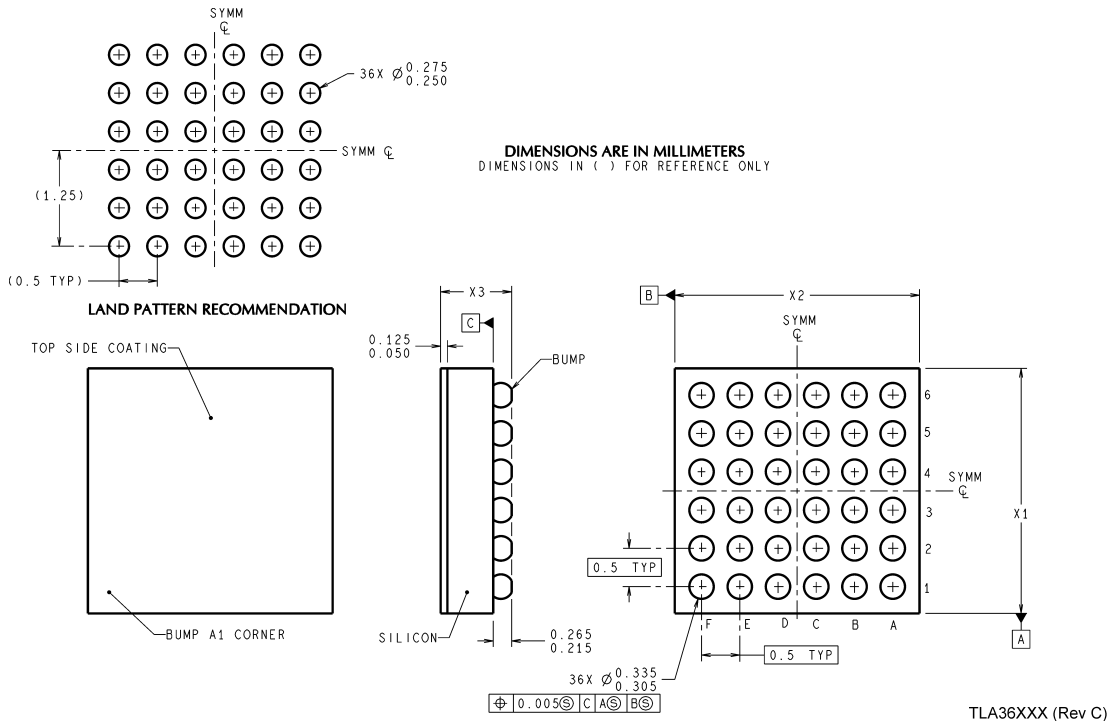

**36-Bump micro SMD**  
**Order Number LM4838ITL, LM4838ITLX**  
**NS Package Number TLA36AAA**  
**X<sub>1</sub> = 3.000±0.03   X<sub>2</sub> = 3.000±0.03   X<sub>3</sub> = 0.600±0.075**

**Physical Dimensions** inches (millimeters) unless otherwise noted (Continued)

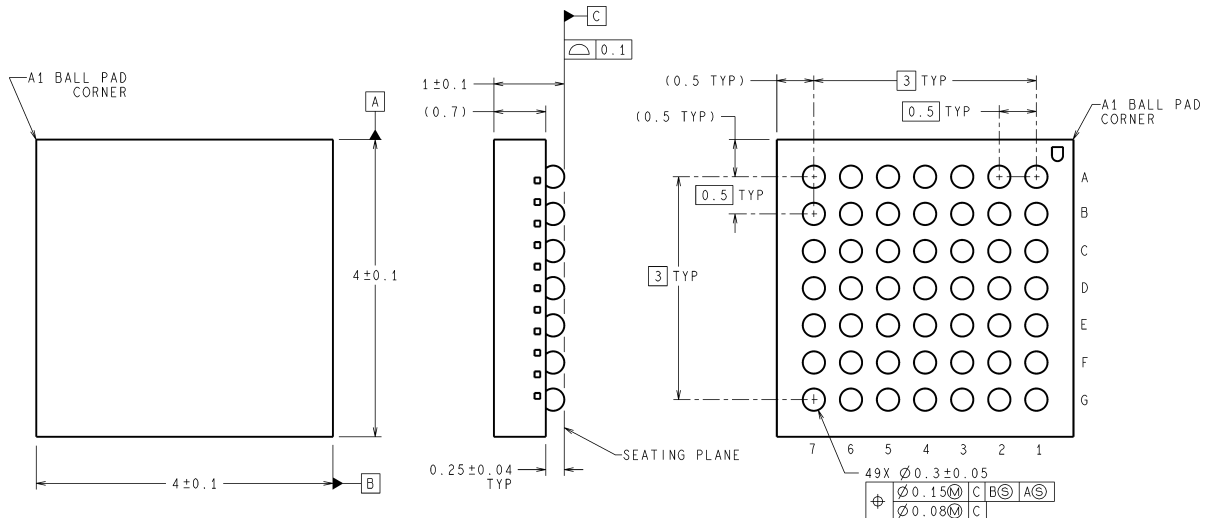

DIMENSIONS ARE IN MILLIMETERS  
DIMENSIONS IN ( ) FOR REFERENCE ONLY

GRA49A (Rev A)

**49-Bump micro Array**  
**Order Number LM4838GR**  
**NS Package Number GRA49A**

National does not assume any responsibility for use of any circuitry described, no circuit patent licenses are implied and National reserves the right at any time without notice to change said circuitry and specifications.

For the most current product information visit us at [www.national.com](http://www.national.com).

**LIFE SUPPORT POLICY**

NATIONAL'S PRODUCTS ARE NOT AUTHORIZED FOR USE AS CRITICAL COMPONENTS IN LIFE SUPPORT DEVICES OR SYSTEMS WITHOUT THE EXPRESS WRITTEN APPROVAL OF THE PRESIDENT AND GENERAL COUNSEL OF NATIONAL SEMICONDUCTOR CORPORATION. As used herein:

1. Life support devices or systems are devices or systems which, (a) are intended for surgical implant into the body, or (b) support or sustain life, and whose failure to perform when properly used in accordance with instructions for use provided in the labeling, can be reasonably expected to result in a significant injury to the user.
2. A critical component is any component of a life support device or system whose failure to perform can be reasonably expected to cause the failure of the life support device or system, or to affect its safety or effectiveness.

**BANNED SUBSTANCE COMPLIANCE**

National Semiconductor certifies that the products and packing materials meet the provisions of the Customer Products Stewardship Specification (CSP-9-111C2) and the Banned Substances and Materials of Interest Specification (CSP-9-111S2) and contain no "Banned Substances" as defined in CSP-9-111S2.

**National Semiconductor**  
**Americas Customer Support Center**  
Email: [new.feedback@nsc.com](mailto:new.feedback@nsc.com)  
Tel: 1-800-272-9959

**National Semiconductor**  
**Europe Customer Support Center**  
Fax: +49 (0) 180-530 85 86  
Email: [europe.support@nsc.com](mailto:europe.support@nsc.com)  
Deutsch Tel: +49 (0) 69 9508 6208  
English Tel: +44 (0) 870 24 0 2171  
Français Tel: +33 (0) 1 41 91 8790

**National Semiconductor**  
**Asia Pacific Customer Support Center**  
Email: [ap.support@nsc.com](mailto:ap.support@nsc.com)

**National Semiconductor**  
**Japan Customer Support Center**  
Fax: 81-3-5639-7507  
Email: [jpn.feedback@nsc.com](mailto:jpn.feedback@nsc.com)  
Tel: 81-3-5639-7560

[www.national.com](http://www.national.com)