

# LM4883 Boomer® Audio Power Amplifier Series

## Dual 2.1W Audio Amplifier Plus Stereo Headphone Function

### General Description

The LM4883 is a dual bridge-connected audio power amplifier which, when connected to a 5V supply, will deliver 2.1W to a 4Ω load (Note 1) or 2.4W to a 3Ω load (Note 2) with less than 1.0% THD+N. In addition, the headphone input pin allows the amplifiers to operate in single-ended mode when driving stereo headphones. A MUX control pin allows selection between the two stereo sets of amplifier inputs. The MUX control can also be used to select two different closed-loop responses.

Boomer audio power amplifiers were designed specifically to provide high quality output power from a surface mount package while requiring few external components. To simplify audio system design, the LM4883SQ combines dual bridge speaker amplifiers and stereo headphone amplifiers on one chip.

The LM4883SQ features an internally controlled, low-power consumption shutdown mode, a stereo headphone amplifier mode, and thermal shutdown protection. It also utilizes circuitry to reduce "clicks and pops" during device turn-on.

**Note 1:** An LM4883SQ that has been properly mounted to a circuit board will deliver 2.1W into 4Ω. See the Application Information sections for further information concerning the LM4883SQ.

**Note 2:** An LM4883SQ that has been properly mounted to a circuit board and forced-air cooled will deliver 2.4W into 3Ω.

### Key Specifications

■ $P_O$ at 1% THD+N	
$R_L = 3\Omega$	2.4W (typ)
$R_L = 4\Omega$	2.1W (typ)
$R_L = 8\Omega$	1.3W (typ)
■ Single-ended mode THD+N at 75mW into 32Ω (5V, 1kHz)	0.01% (typ)
■ Shutdown current	0.04μA (typ)
■ Supply voltage range	2.4V to 5.5V
■ PSRR at 217Hz	85dB (typ)

### Features

- Input mux control and two separate inputs per channel
- Stereo headphone amplifier mode
- Improved "click and pop" suppression circuitry
- Thermal shutdown protection circuitry
- PCB area-saving SQ package

### Applications

- Multimedia monitors
- Portable and desktop computers
- Portable audio systems

### Connection Diagrams

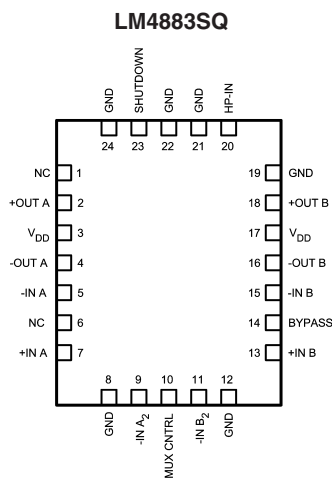

200887A3

**Top View**  
Order Number LM4883SQ  
See NS Package Number SQA24B

**LM4883SQ Top Mark**



200887C6

**Top View**  
U = Fab Code  
Z = Assembly Plant Code  
XY = Date Code  
TT = Die Traceability

## Typical Application

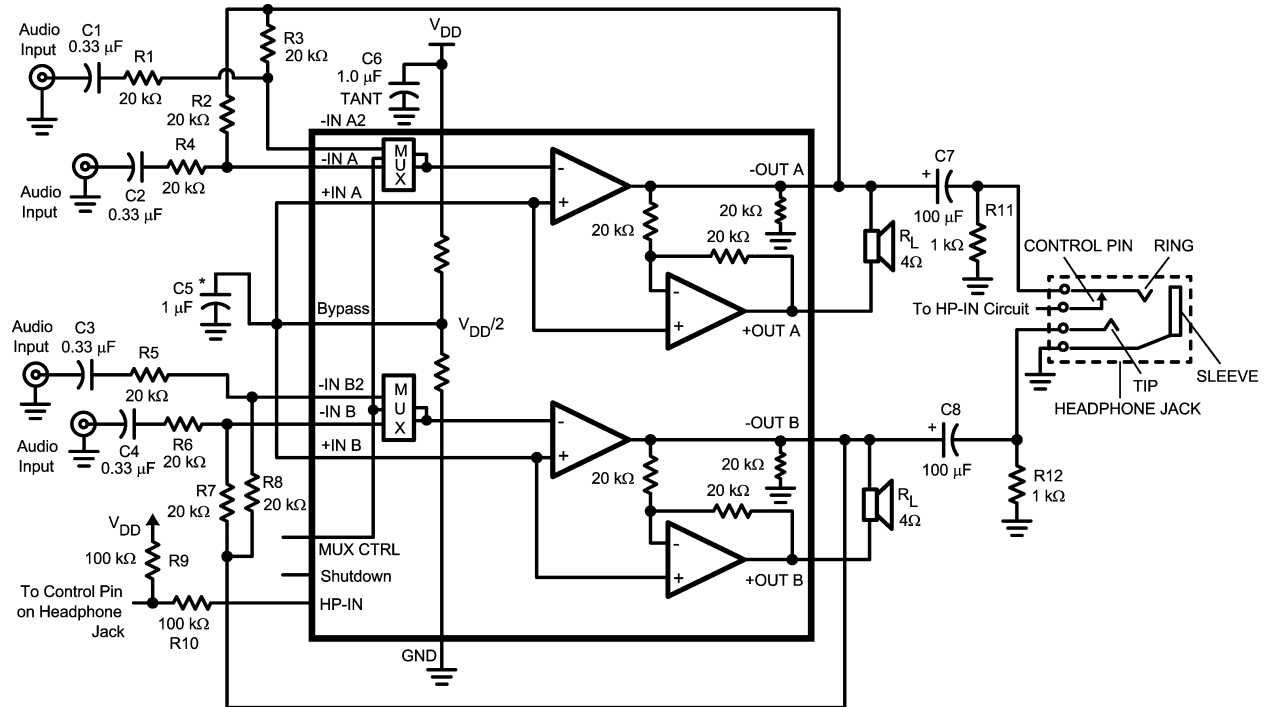

200887A1

FIGURE 1. Typical Audio Amplifier Application Circuit

## External Components Description

(Refer to Figure 1)

Components	Functional Description
1. R1, 4, 5, 6	The inverting input resistance R1, along with R3, set the closed-loop gain. R1, along with C1, form a high pass filter with $f_c = 1/(2\pi R_1 C_1)$ .
2. C1, 2, 3, 4	The input coupling capacitor blocks DC voltage at the amplifier's input terminals. C1, along with R1, create a highpass filter with $f_c = 1/(2\pi R_1 C_1)$ . Refer to the section, <b>SELECTING PROPER EXTERNAL COMPONENTS</b> , for an explanation of determining the value of C1.
3. R2, 3, 7, 8	The feedback resistance, along with R1 sets the closed-loop gain.
4. C6	The supply bypass capacitor. Refer to the <b>POWER SUPPLY BYPASSING</b> section for information about properly placing, and selecting the value of, this capacitor.
5. C5	The capacitor, C5, filters the half-supply voltage present on the BYPASS pin. Refer to the <b>SELECTING PROPER EXTERNAL COMPONENTS</b> section for information concerning proper placement and selecting C5's value.

**Absolute Maximum Ratings** (Note 3)

If Military/Aerospace specified devices are required, please contact the National Semiconductor Sales Office/Distributors for availability and specifications.

Supply Voltage	6.0V
Storage Temperature	-65°C to +150°C
Input Voltage	-0.3V to $V_{DD}$ +0.3V
Power Dissipation (Note 4)	Internally limited
ESD Susceptibility (Note 5)	2000V
ESD Susceptibility (Note 6)	200V
Junction Temperature	150°C
Solder Information	

Small Outline Package

Vapor Phase (60 sec.)

215°C

Infrared (15 sec.)

220°C

Thermal Resistance

 $\theta_{JC}$  (typ)—SQA24B

3°C/W

 $\theta_{JA}$  (typ)—SQA24B

42°C/W

**Operating Ratings**

Temperature Range

 $T_{MIN} \leq T_A \leq T_{MAX}$ -40°C  $\leq T_A \leq$  85°C

Supply Voltage

2.4V  $\leq V_{DD} \leq$  5.5V**Electrical Characteristics (5V)** (Notes 3, 7, 13)The following specifications apply for  $V_{DD} = 5V$  unless otherwise noted. Limits apply for  $T_A = 25^\circ C$ .

Symbol	Parameter	Conditions	LM4883		Units (Limits)
			Typical (Note 8)	Limit (Note 9)	
$V_{DD}$	Supply Voltage			2.4	V (min)
				5.5	V (max)
$I_{DD}$	Quiescent Power Supply Current	$V_{IN} = 0V, I_O = 0A$ (Note 10), HP-IN = 0V	6	10	mA (max)
		$V_{IN} = 0V, I_O = 0A$ (Note 10), HP-IN = 4V	3.0	6	mA (min)
$I_{SD}$	Shutdown Current	$V_{DD}$ applied to the SHUTDOWN pin	0.04	2	$\mu A$ (max)
$V_{IH}$	Headphone High Input Voltage		3.7	4	V (min)
$V_{IL}$	Headphone Low Input Voltage		2.6	0.8	V (max)
$V_{IHSD}$	Shutdown High Input Voltage			$0.7V_{DD}$	V (min)
$V_{ILSD}$	Shutdown Low Input Voltage			$0.3V_{DD}$	V (max)
$T_{WU}$	Turn On Time	1 $\mu F$ Bypass Cap (C5)	140		ms

**Electrical Characteristics for Bridged-Mode Operation (5V)** (Notes 3, 7, 13)The following specifications apply for  $V_{DD} = 5V$  unless otherwise specified. Limits apply for  $T_A = 25^\circ C$ .

Symbol	Parameter	Conditions	LM4883		Units (Limits)	
			Typical (Note 8)	Limit (Note 9)		
$V_{OS}$	Output Offset Voltage	$V_{IN} = 0V$	5	45	mV (max)	
$P_O$	Output Power (Note 11)	THD+N = 1%, f = 1kHz (Note 12)				
		LM4883SQ, $R_L = 3\Omega$	2.4		W	
		LM4883SQ, $R_L = 4\Omega$	2.1		W	
		LM4883SQ, $R_L = 8\Omega$	1.3	1.0	W (min)	
		THD+N = 10%, f = 1kHz (Note 12)				
		LM4883SQ, $R_L = 3\Omega$	3.0		W	
	LM4883SQ, $R_L = 4\Omega$	2.5		W		
	LM4883SQ, $R_L = 8\Omega$	1.7		W		
THD+N	Total Harmonic Distortion+Noise	1kHz, $A_{VD} = 2$				
		LM4883SQ, $R_L = 4\Omega, P_O = 1W$	0.10		%	
		LM4883SQ, $R_L = 8\Omega, P_O = .4W$	0.06		%	

**Electrical Characteristics for Bridged-Mode Operation (5V)** (Notes 3, 7,

13) (Continued)

The following specifications apply for  $V_{DD} = 5V$  unless otherwise specified. Limits apply for  $T_A = 25^\circ C$ .

Symbol	Parameter	Conditions	LM4883		Units (Limits)
			Typical (Note 8)	Limit (Note 9)	
PSRR	Power Supply Rejection Ratio	Input Floating, 217Hz $V_{ripple} = 200mV_{p-p}$ $C_B = 1\mu F, R_L = 8\Omega$	85		dB
		Input Floating, 1kHz $V_{ripple} = 200mV_{p-p}$ $C_B = 1\mu F, R_L = 8\Omega$	80		dB
		Input grounded, 217Hz $V_{ripple} = 200mV_{p-p}$ $C_B = 1\mu F, R_L = 8\Omega$	65		dB
		Input grounded, 1kHz $V_{ripple} = 200mV_{p-p}$ $C_B = 1\mu F, R_L = 8\Omega$	70		dB
$X_{TALK}$	Channel Separation	$f = 1kHz, C_B = 1.0\mu F$	82		dB
$V_{NO}$	Output Noise Voltage	1kHz, A-weighted	21		$\mu V$

**Electrical Characteristics for Single-Ended Operation (5V)** (Notes 3, 7, 13)The following specifications apply for  $V_{DD} = 5V$  unless otherwise specified. Limits apply for  $T_A = 25^\circ C$ .

Symbol	Parameter	Conditions	LM4883		Units (Limits)
			Typical (Note 8)	Limit (Note 9)	
$P_O$	Output Power	THD+N = 0.5%, $f = 1 kHz, R_L = 32\Omega$	90	75	mW (min)
		THD+N = 1%, $f = 1 kHz, R_L = 8\Omega$	325		mW
		THD+N = 10%, $f = 1 kHz, R_L = 8\Omega$	400		mW
THD+N	Total Harmonic Distortion+Noise	$P_O = 20mW, 1kHz, R_L = 32\Omega$	0.015		%
PSRR	Power Supply Rejection Ratio	Input Floating, 217Hz $V_{ripple} = 200mV_{p-p}$ $C_B = 1\mu F, R_L = 8\Omega$	70		dB
		Input Floating, 1kHz $V_{ripple} = 200mV_{p-p}$ $C_B = 1\mu F, R_L = 8\Omega$	72		dB
		Input grounded, 217Hz $V_{ripple} = 200mV_{p-p}$ $C_B = 1\mu F, R_L = 8\Omega$	65		dB
		Input grounded, 1kHz $V_{ripple} = 200mV_{p-p}$ $C_B = 1\mu F, R_L = 8\Omega$	70		dB
$X_{TALK}$	Channel Separation	$f = 1kHz, C_B = 1.0\mu F$	80		dB
$V_{NO}$	Output Noise Voltage	1kHz, A-weighted	11		$\mu V$

**Electrical Characteristics (3V)** (Notes 3, 7, 13)

The following specifications apply for  $V_{DD} = 3V$  unless otherwise noted. Limits apply for  $T_A = 25^\circ C$ .

Symbol	Parameter	Conditions	LM4883		Units (Limits)
			Typical (Note 8)	Limit (Note 9)	
$I_{DD}$	Quiescent Power Supply Current	$V_{IN} = 0V, I_O = 0A$ (Note 10), HP-IN = 0V	4.5		mA
		$V_{IN} = 0V, I_O = 0A$ (Note 10), HP-IN = 4V	2.5		mA
$I_{SD}$	Shutdown Current	$V_{DD}$ applied to the SHUTDOWN pin	0.01		$\mu A$
$V_{IH}$	Headphone High Input Voltage		2.2		V
$V_{IL}$	Headphone Low Input Voltage		1.5		V
$V_{IHSD}$	Shutdown High Input Voltage			$0.7V_{DD}$	V (min)
$V_{ILSD}$	Shutdown Low Input Voltage			$0.3V_{DD}$	V (max)
$T_{WU}$	Turn On Time	1 $\mu F$ Bypass Cap (C5)	140		ms

**Electrical Characteristics for Bridged-Mode Operation (3V)** (Notes 3, 7, 13)

The following specifications apply for  $V_{DD} = 3V$  unless otherwise specified. Limits apply for  $T_A = 25^\circ C$ .

Symbol	Parameter	Conditions	LM4883		Units (Limits)	
			Typical (Note 8)	Limit (Note 9)		
$V_{OS}$	Output Offset Voltage	$V_{IN} = 0V$	5		mV	
$P_O$	Output Power (Note 11)	THD+N = 1%, $f = 1kHz$ (Note 12)				
		LM4883SQ, $R_L = 3\Omega$	.82		W	
		LM4883SQ, $R_L = 4\Omega$	.70		W	
		LM4883SQ, $R_L = 8\Omega$	.43		W	
		THD+N = 10%, $f = 1kHz$ (Note 12)				
		LM4883SQ, $R_L = 3\Omega$	1.0		W	
THD+N	Total Harmonic Distortion+Noise	1kHz				
		LM4883SQ, $R_L = 4\Omega, P_O = 280mW$	0.1		%	
		LM4883SQ, $R_L = 8\Omega, P_O = 200mW$	0.05		%	
PSRR	Power Supply Rejection Ratio	Input Floating, 217Hz $V_{ripple} = 200mV_{p-p}$ $C_B = 1\mu F, R_L = 8\Omega$	90		dB	
		Input Floating, 1kHz $V_{ripple} = 200mV_{p-p}$ $C_B = 1\mu F, R_L = 8\Omega$	80		dB	
		Input grounded, 217Hz $V_{ripple} = 200mV_{p-p}$ $C_B = 1\mu F, R_L = 8\Omega$	65		dB	
		Input grounded, 1kHz $V_{ripple} = 200mV_{p-p}$ $C_B = 1\mu F, R_L = 8\Omega$	73		dB	
$X_{TALK}$	Channel Separation	$f = 1kHz, C_B = 1.0\mu F$	85		dB	
$V_{NO}$	Output Noise Voltage	1kHz, A-weighted	21		$\mu V$	

## Electrical Characteristics for Single-Ended Operation (3V) (Notes 3, 7, 13)

The following specifications apply for  $V_{DD} = 3V$  unless otherwise specified. Limits apply for  $T_A = 25^\circ C$ .

Symbol	Parameter	Conditions	LM4883		Units (Limits)
			Typical (Note 8)	Limit (Note 9)	
$P_O$	Output Power	THD+N = 0.5%, $f = 1 \text{ kHz}$ , $R_L = 32\Omega$	35		mW
		THD+N = 1%, $f = 1 \text{ kHz}$ , $R_L = 8\Omega$	125		mW
		THD+N = 10%, $f = 1 \text{ kHz}$ , $R_L = 8\Omega$	150		mW
THD+N	Total Harmonic Distortion+Noise	$P_O = 35\text{mW}$ , $20\text{Hz} \leq f \leq 20\text{kHz}$ , $R_L = 32\Omega$	.015		%
PSRR	Power Supply Rejection Ratio	Input Floating, 217Hz $V_{\text{ripple}} = 200\text{mV}_{\text{p-p}}$ $C_B = 1\mu\text{F}$ , $R_L = 8\Omega$	71		dB
		Input Floating, 1kHz $V_{\text{ripple}} = 200\text{mV}_{\text{p-p}}$ $C_B = 1\mu\text{F}$ , $R_L = 8\Omega$	79		dB
		Input grounded, 217Hz $V_{\text{ripple}} = 200\text{mV}_{\text{p-p}}$ $C_B = 1\mu\text{F}$ , $R_L = 32\Omega$	65		dB
		Input grounded, 1kHz $V_{\text{ripple}} = 200\text{mV}_{\text{p-p}}$ $C_B = 1\mu\text{F}$ , $R_L = 32\Omega$	72		dB
$X_{\text{TALK}}$	Channel Separation	$f = 1\text{kHz}$ , $C_B = 1.0\mu\text{F}$	80		dB
$V_{\text{NO}}$	Output Noise Voltage	1kHz, A-weighted	11		$\mu\text{V}$

**Note 3:** Absolute Maximum Ratings indicate limits beyond which damage to the device may occur. Operating Ratings indicate conditions for which the device is functional, but do not guarantee specific performance limits. Electrical Characteristics state DC and AC electrical specifications under particular test conditions which guarantee specific performance limits. This assumes that the device operates within the Operating Ratings. Specifications are not guaranteed for parameters where no limit is given. The typical value however, is a good indication of device performance.

**Note 4:** The maximum power dissipation must be derated at elevated temperatures and is dictated by  $T_{\text{JMAX}}$ ,  $\theta_{\text{JA}}$ , and the ambient temperature  $T_A$ . The maximum allowable power dissipation is  $P_{\text{DMAX}} = (T_{\text{JMAX}} - T_A)/\theta_{\text{JA}}$ . For the LM4883SQ,  $T_{\text{JMAX}} = 150^\circ\text{C}$ .

**Note 5:** Human body model, 100 pF discharged through a 1.5 k $\Omega$  resistor.

**Note 6:** Machine model, 220 pF–240 pF discharged through all pins.

**Note 7:** All voltages are measured with respect to the ground (GND) pins, unless otherwise specified.

**Note 8:** Typicals are specified at  $25^\circ\text{C}$  and represent the parametric norm.

**Note 9:** Datasheet min/max specification limits are guaranteed by design, test, or statistical analysis.

**Note 10:** The quiescent power supply current depends on the offset voltage when a practical load is connected to the amplifier.

**Note 11:** Output power is measured at the device terminals.

**Note 12:** When driving 3 $\Omega$  or 4 $\Omega$  loads and operating on a 5V supply, the LM4883SQ must be mounted to a circuit board that has a minimum of 2.5in<sup>2</sup> of exposed, uninterrupted copper area connected to the SQ package's exposed DAP.

**Note 13:** All measurements taken from Applications Diagram (Figure 3).

# Typical Performance Characteristics

**THD+N vs Output Power**  
5V, 8Ω, BTL at 1kHz

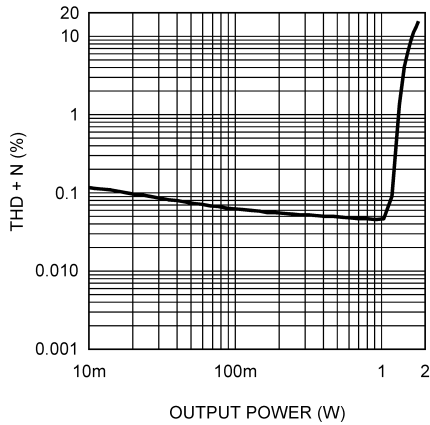

200887B6

**THD+N vs Output Power**  
5V, 4Ω, BTL at 1kHz

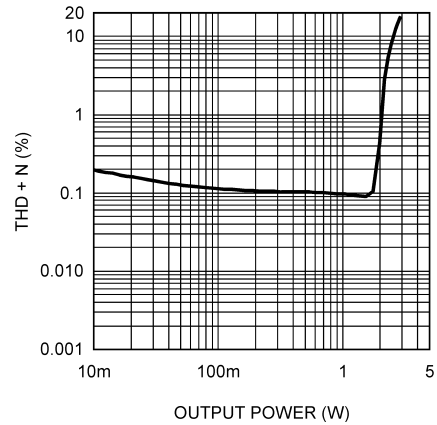

200887B5

**THD+N vs Output Power**  
5V, 3Ω, BTL at 1kHz

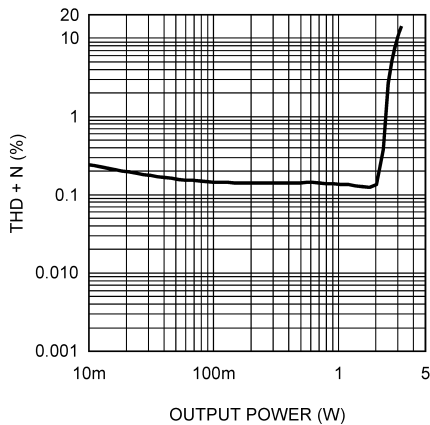

200887B4

**THD+N vs Output Power**  
5V, 32Ω, BTL at 1kHz

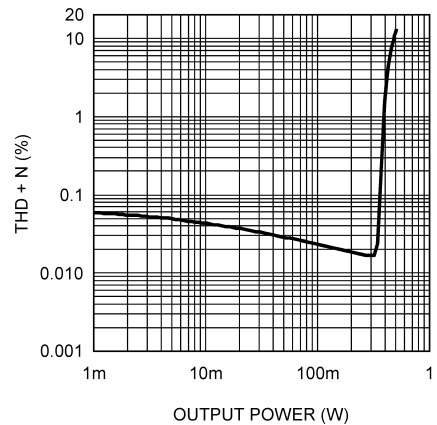

200887B8

**THD+N vs Output Power**  
5V, 8Ω, SE at 1kHz

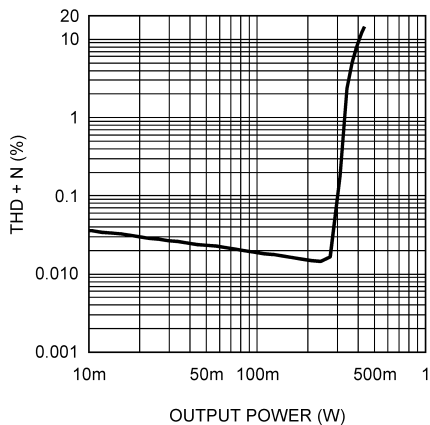

200887B7

**THD+N vs Output Power**  
5V, 32Ω, SE at 1kHz

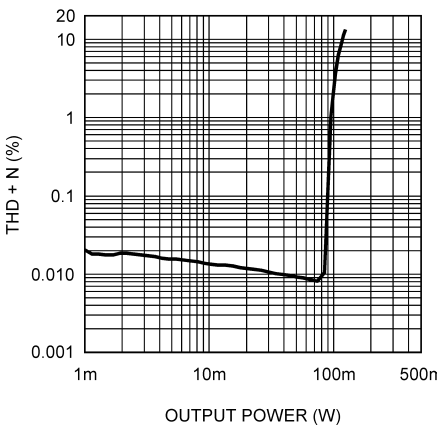

200887B9

Typical Performance Characteristics (Continued)

**THD+N vs Output Power**  
3V, 8Ω, BTL at 1kHz

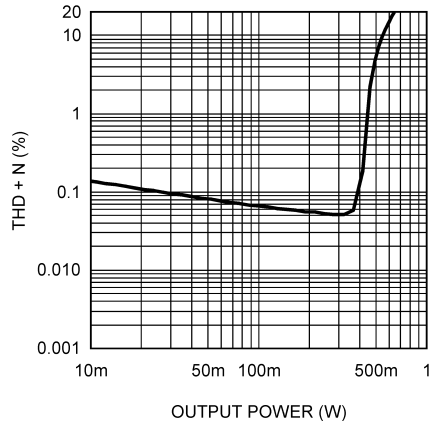

20088780

**THD+N vs Output Power**  
3V, 4Ω, BTL at 1kHz

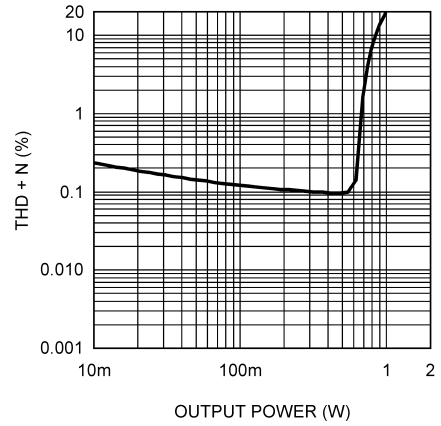

20088779

**THD+N vs Output Power**  
3V, 3Ω, BTL at 1kHz

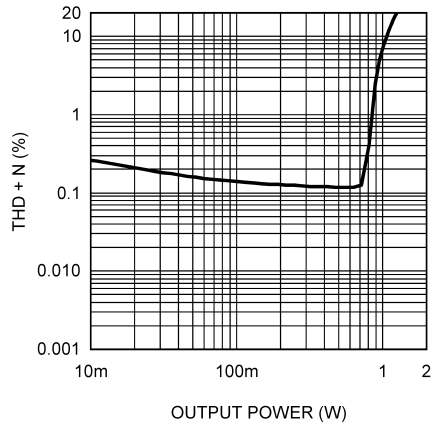

20088778

**THD+N vs Output Power**  
3V, 32Ω, BTL at 1kHz

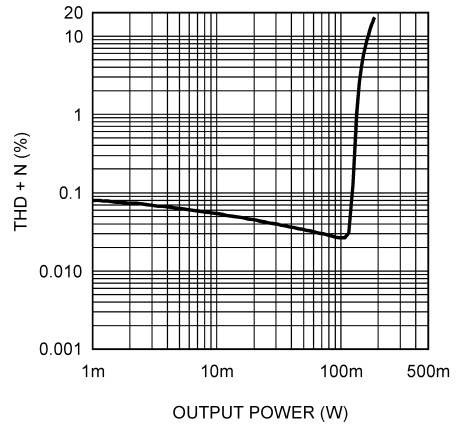

20088782

**THD+N vs Output Power**  
3V, 8Ω, SE at 1kHz

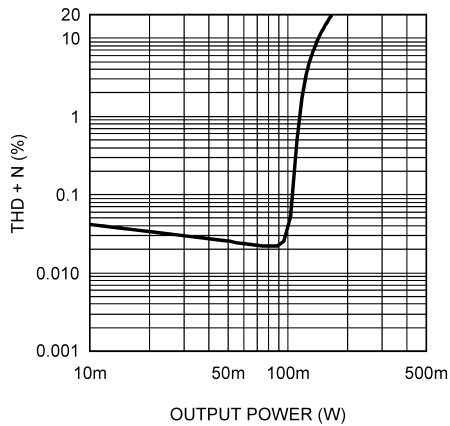

20088781

**THD+N vs Output Power**  
3V, 32Ω, SE at 1kHz

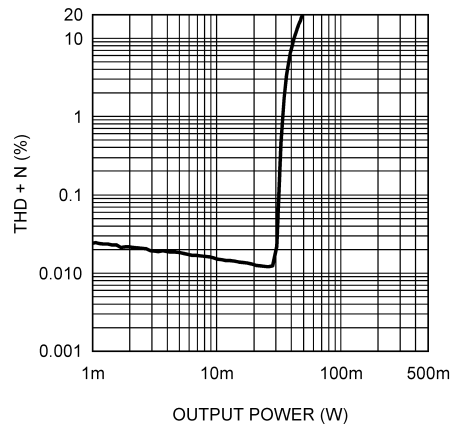

20088783



Typical Performance Characteristics (Continued)

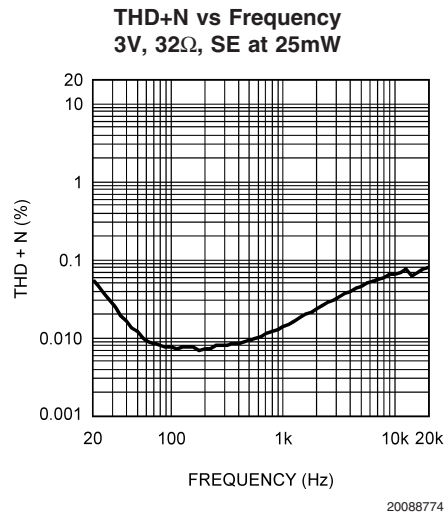
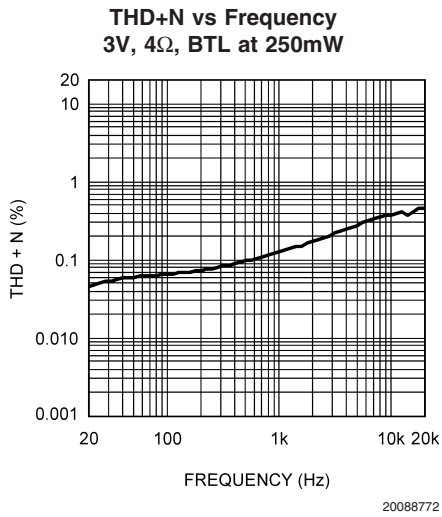
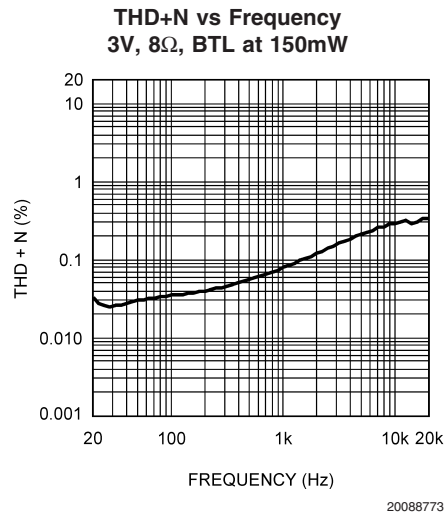
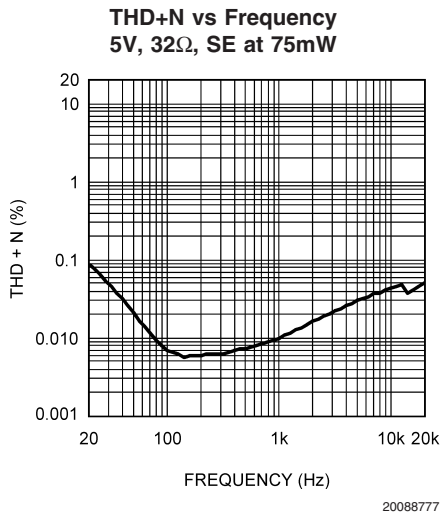
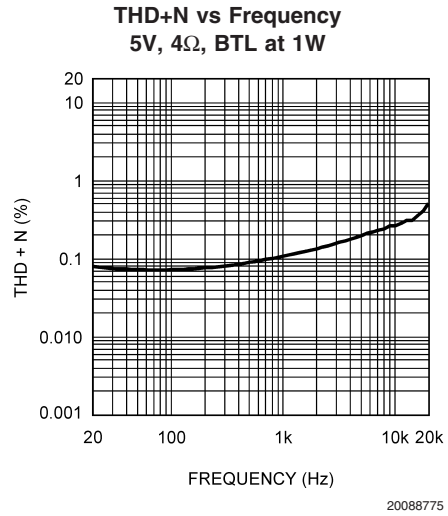
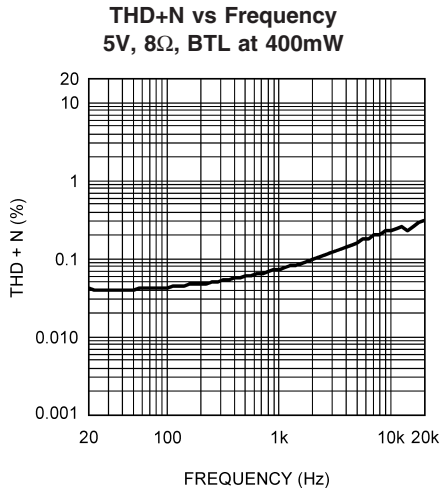

# Typical Performance Characteristics (Continued)

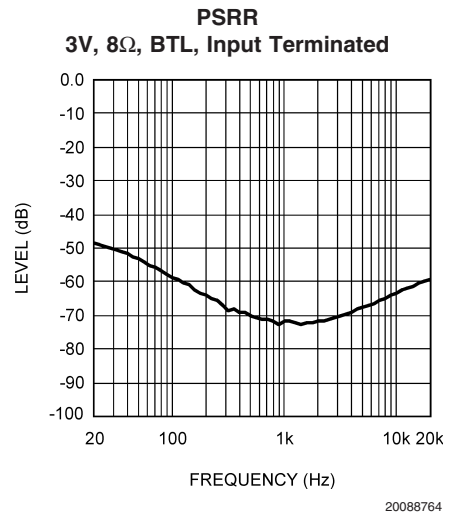
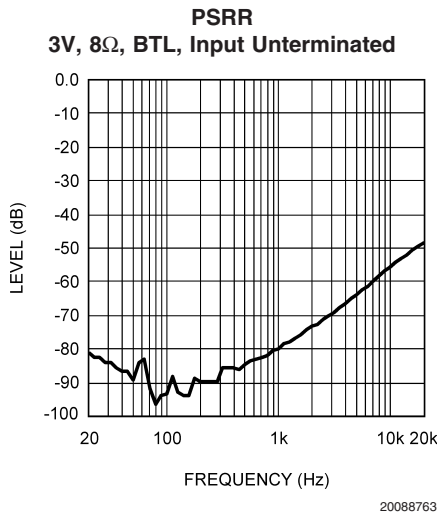
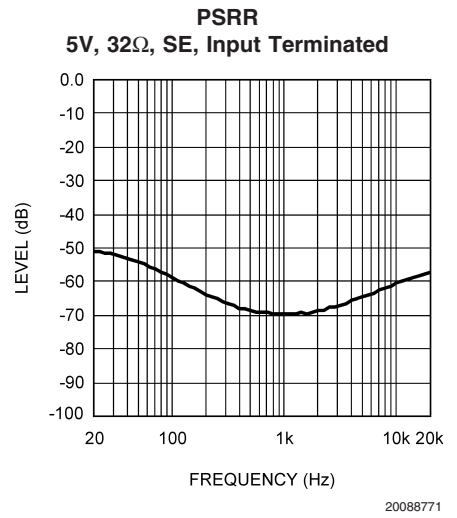
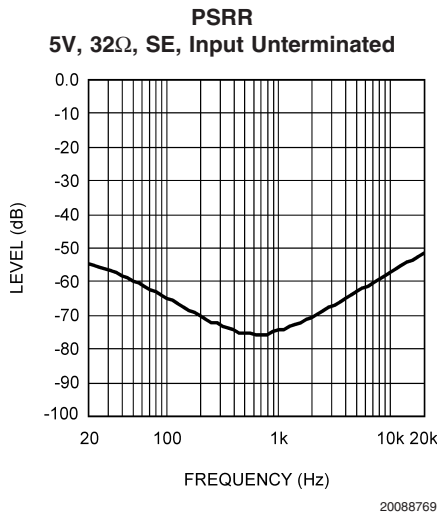
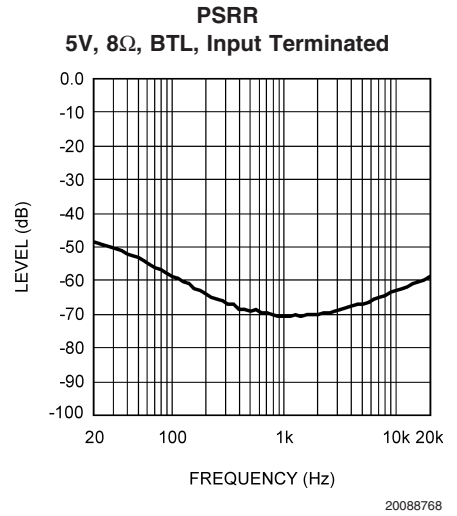
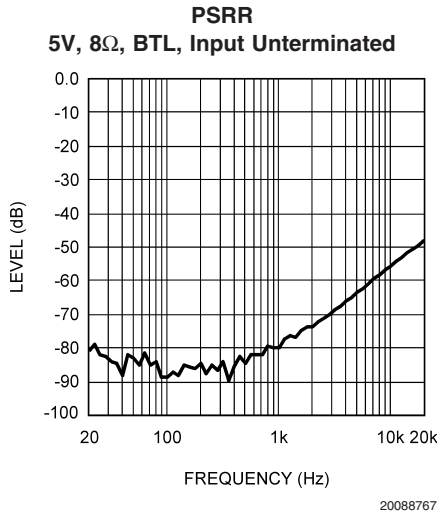

# Typical Performance Characteristics (Continued)

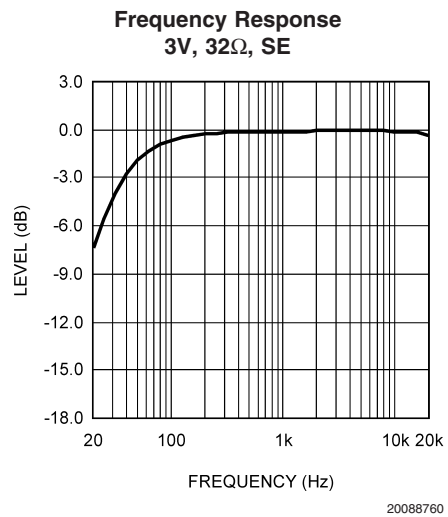
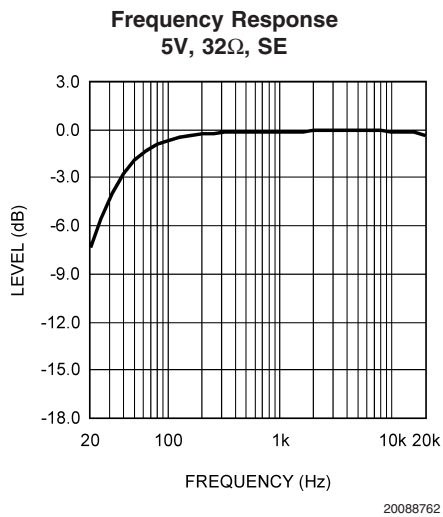
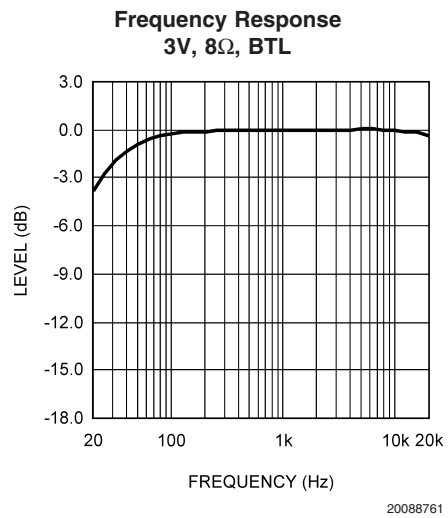
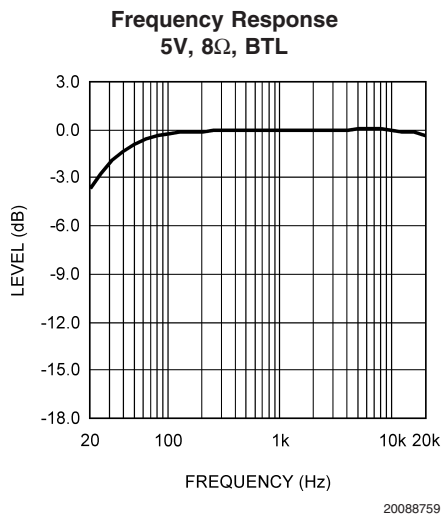
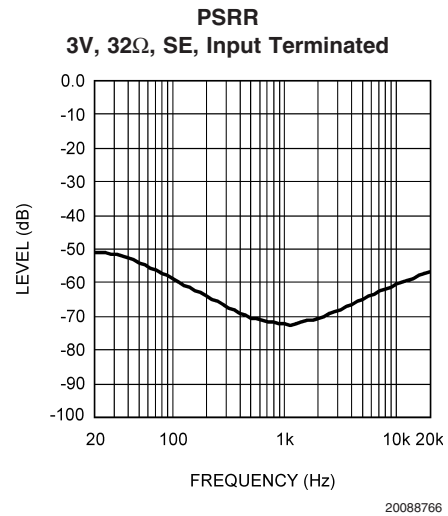
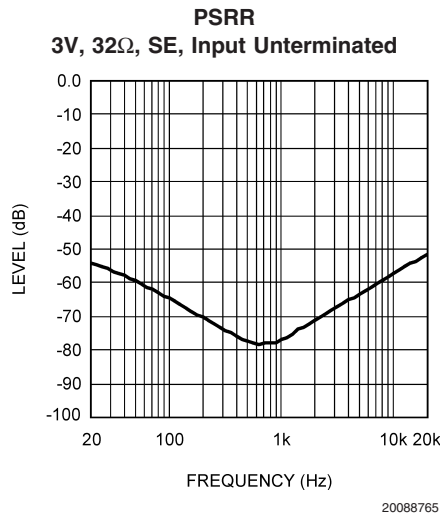

Typical Performance Characteristics (Continued)

**Crosstalk**  
5V, 8Ω, BTL

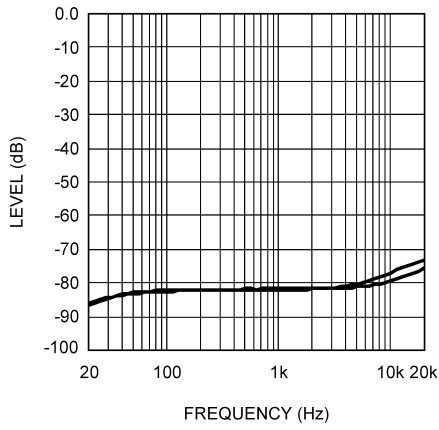

20088749

**Crosstalk**  
3V, 8Ω, BTL

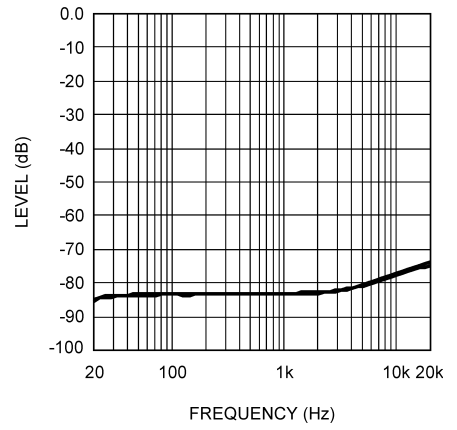

20088735

**Crosstalk**  
3V, 32Ω, SE

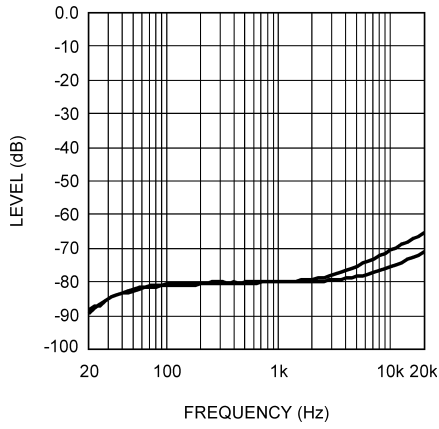

20088737

**Dropout Voltage vs**  
Supply Voltage

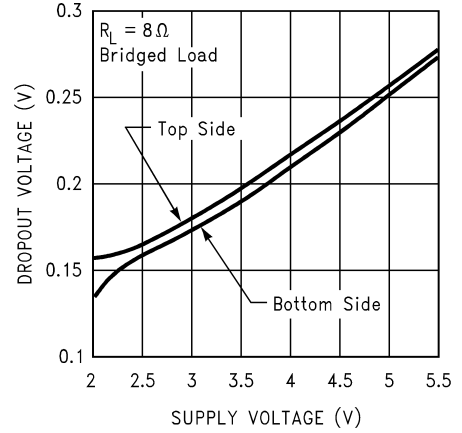

200887C0

**Output Power vs**  
Supply Voltage

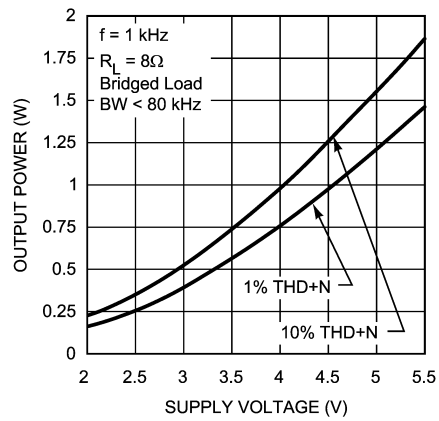

200887C2

**Open Loop**  
Frequency Response

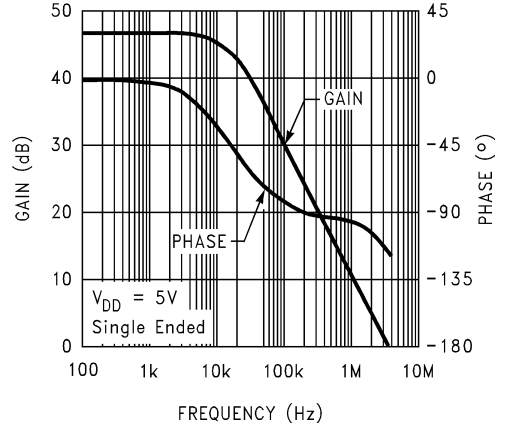

200887C1

Typical Performance Characteristics (Continued)

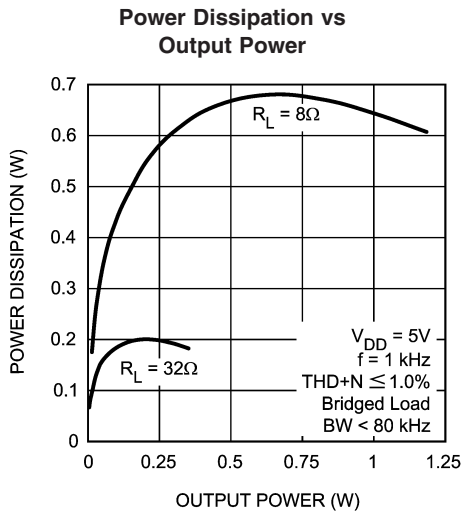

200887C4

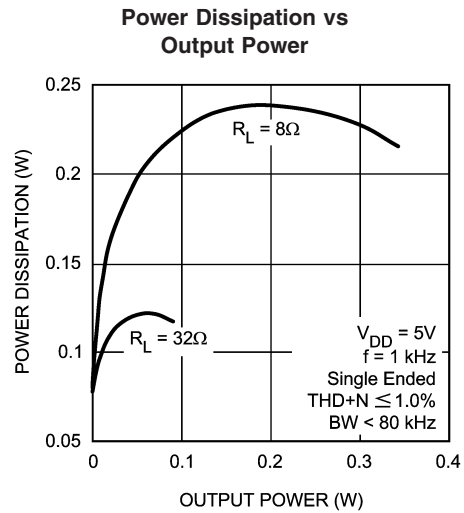

200887C5

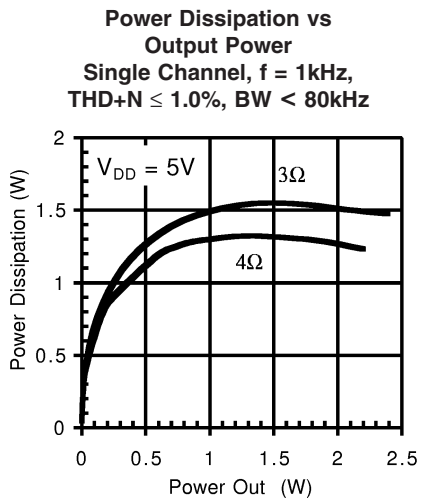

200887C7

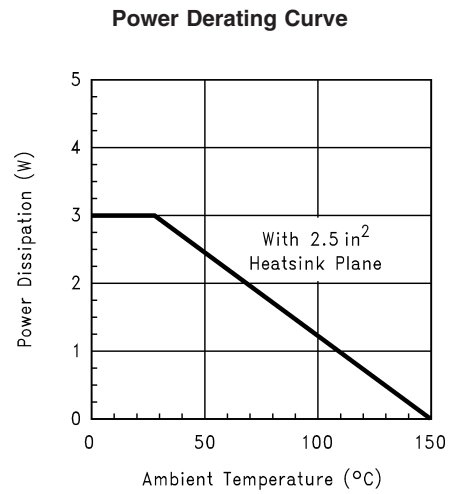

200887C8

## Application Information

### STEREO-INPUT MULTIPLEXER (STEREO MUX)

Typical LM4883 applications use the MUX to switch between two stereo input signals. Each stereo channel's gain can be tailored to produce the required output signal level. Choosing the input and feedback resistor ratio sets a MUX channel's gain. Another configuration uses the MUX to select two different gains or frequency compensated gains to amplify a single pair of stereo input signals. *Figure 2* shows two different feedback networks, Network 1 and Network 2. Network 1 produces increasing gain as the input signal's frequency decreases. This can be used to compensate a small, full-range speaker's low frequency response roll-off. Network 2 sets the gain for an alternate load such as headphones. Connecting the MUX CTRL and HP-IN pins together applies the same control voltage to the MUX pins when connecting and disconnecting headphones using the headphone jack shown in *Figure 3* or *Figure 4*. Simultaneously applying the control voltage automatically selects the amplifier (headphone or bridge loads) and switches the gain (MUX channel selection). Alternatively, leave the control pins independently accessible. This allows a user to select bass boost as needed. This alternative user-selectable bass-boost scheme requires connecting equal ratio resistor feedback networks to each MUX input channel. The value of the resistor in the RC network is chosen to give a gain that is necessary to achieve the desired bass-boost.

Switching between the MUX channels may change the input signal source or the feedback resistor network. During the channel switching transition, the average voltage level present on the internal amplifier's input may change. This change can slew at a rate that may produce audible voltage transients or clicks in the amplifier's output signal. Using the MUX to select between two vastly dissimilar gains is a typical transient-producing situation. As the MUX is switched, an audible click may occur as the gain suddenly changes.

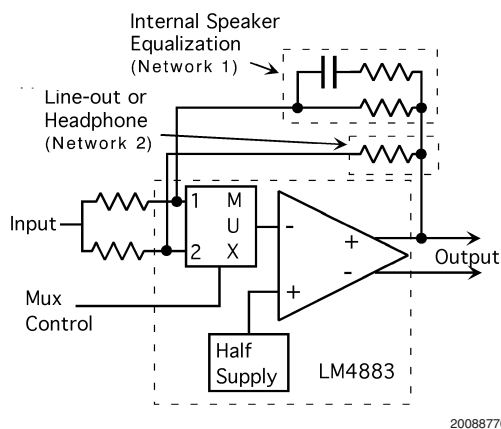

FIGURE 2. Input MUX Example

### EXPOSED-DAP PACKAGE PCB MOUNTING CONSIDERATIONS

The LM4883's SQ exposed-DAP (die attach paddle) package provides a low thermal resistance between the die and the PCB to which the part is mounted and soldered. This

allows rapid heat transfer from the die to the surrounding PCB copper traces, ground plane and, finally, surrounding air. The result is a low voltage audio power amplifier that produces 2.1W at  $\leq 1\%$  THD with a  $4\Omega$  load. This high power is achieved through careful consideration of necessary thermal design. Failing to optimize thermal design may compromise the LM4883SQ's high power performance and activate unwanted, though necessary, thermal shutdown protection.

The SQ package must have its DAP soldered to a copper pad on the PCB. The DAP's PCB copper pad is connected to a large plane of continuous unbroken copper. This plane forms a thermal mass and heat sink and radiation area. Place the heat sink area on either outside plane in the case of a two-sided PCB, or on an inner layer of a board with more than two layers. Connect the DAP copper pad to the inner layer or backside copper heat sink area with 6 (3x2) SQ vias. The via diameter should be 0.012in–0.013in with a 1.27mm pitch. Ensure efficient thermal conductivity by plating-through and solder-filling the vias.

Best thermal performance is achieved with the largest practical copper heat sink area. If the heatsink and amplifier share the same PCB layer, a nominal  $2.5\text{in}^2$  (min) area is necessary for 5V operation with a  $4\Omega$  load. Heatsink areas not placed on the same PCB layer as the LM4883SQ should be  $5\text{in}^2$  (min) for the same supply voltage and load resistance. The last two area recommendations apply for  $25^\circ\text{C}$  ambient temperature. Increase the area to compensate for ambient temperatures above  $25^\circ\text{C}$ . In all circumstances and conditions, the junction temperature must be held below  $150^\circ\text{C}$  to prevent activating the LM4883SQ's thermal shutdown protection. The LM4883SQ's power de-rating curve in the **Typical Performance Characteristics** shows the maximum power dissipation versus temperature. Example PCB layouts for the exposed-Dap SQ package is shown in the **Demonstration Board Layout** section. Further detailed and specific information concerning PCB layout, fabrication, and mounting an SQ package is available from National Semiconductor's AN1187.

### PCB LAYOUT AND SUPPLY REGULATION

#### CONSIDERATIONS FOR DRIVING $3\Omega$ AND $4\Omega$ LOADS

Power dissipated by a load is a function of the voltage swing across the load and the load's impedance. As load impedance decreases, load dissipation becomes increasingly dependent on the interconnect (PCB trace and wire) resistance between the amplifier output pins and the load's connections. Residual trace resistance causes a voltage drop, which results in power dissipated in the trace and not in the load as desired. For example,  $0.1\Omega$  trace resistance reduces the output power dissipated by a  $4\Omega$  load from 2.1W to 2.0W. This problem of decreased load dissipation is exacerbated as load impedance decreases. Therefore, to maintain the highest load dissipation and widest output voltage swing, PCB traces that connect the output pins to a load must be as wide as possible.

Poor power supply regulation adversely affects maximum output power. A poorly regulated supply's output voltage decreases with increasing load current. Reduced supply voltage causes decreased headroom, output signal clipping, and reduced output power. Even with tightly regulated supplies, trace resistance creates the same effects as poor supply regulation. Therefore, making the power supply traces as wide as possible helps maintain full output voltage swing.

## Application Information (Continued)

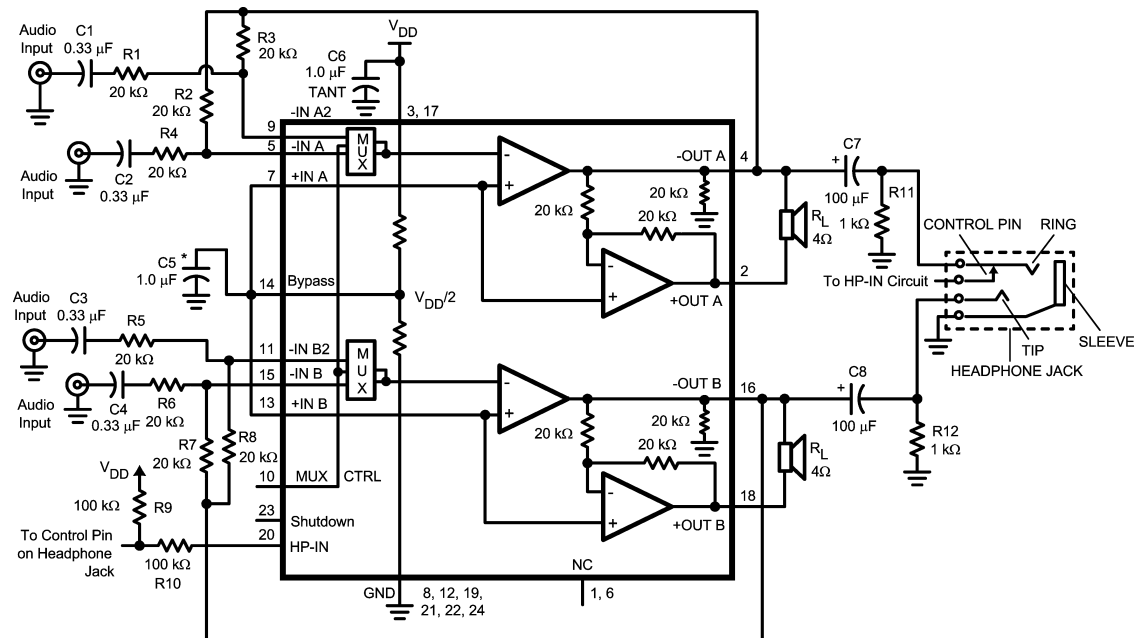

200887A4

\* Refer to the section Selecting Proper External Components, for a detailed discussion of C5 size.

**FIGURE 3. Typical Audio Amplifier Application Circuit**

### BRIDGE CONFIGURATION EXPLANATION

As shown in *Figure 3*, the LM4883 consists of two pairs of operational amplifiers, forming a two-channel (channel A and channel B) stereo amplifier. External feedback resistors  $R_{3,2,7,8}$  and input resistors  $R_{1,4,5,6}$  set the closed-loop gain of Amp A (-out) and Amp B (-out) whereas two internal 20kΩ resistors set Amp A's (+out) and Amp B's (+out) gain at 1. The LM4883 drives a load, such as a speaker, connected between the two amplifier outputs, -OUTA and +OUTA.

*Figure 3* shows that Amp A's (-out) output serves as Amp A's (+out) input. This results in both amplifiers producing signals identical in magnitude, but 180° out of phase. Taking advantage of this phase difference, a load is placed between -OUTA and +OUTA and driven differentially (commonly referred to as "bridge mode"). This results in a differential gain of

$$A_{VD} = 2 * (R_f/R_i) \quad (1)$$

or

$$A_{VD} = 2 * (R_3/R_1)$$

Bridge mode amplifiers are different from single-ended amplifiers that drive loads connected between a single amplifier's output and ground. For a given supply voltage, bridge mode has a distinct advantage over the single-ended configuration: its differential output doubles the voltage swing across the load. This produces four times the output power when compared to a single-ended amplifier under the same conditions. This increase in attainable output power assumes that the amplifier is not current limited or that the output signal is not clipped. To ensure minimum output signal clipping when choosing an amplifier's closed-loop gain, refer to the **Audio Power Amplifier Design** section.

Another advantage of the differential bridge output is no net DC voltage across the load. This is accomplished by biasing

channel A's and channel B's outputs at half-supply. This eliminates the coupling capacitor that single supply, single-ended amplifiers require. Eliminating an output coupling capacitor in a single-ended configuration forces a single-supply amplifier's half-supply bias voltage across the load. This increases internal IC power dissipation and may permanently damage loads such as speakers.

### POWER DISSIPATION

Power dissipation is a major concern when designing a successful single-ended or bridged amplifier. Equation (2) states the maximum power dissipation point for a single-ended amplifier operating at a given supply voltage and driving a specified output load.

$$P_{DMAX} = (V_{DD})^2 / (2\pi^2 R_L) \quad \text{Single-Ended} \quad (2)$$

However, a direct consequence of the increased power delivered to the load by a bridge amplifier is higher internal power dissipation for the same conditions.

The LM4883 has two operational amplifiers per channel. The maximum internal power dissipation per channel operating in the bridge mode is four times that of a single-ended amplifier. From Equation (3), assuming a 5V power supply and a 4Ω load, the maximum single channel power dissipation is 1.27W or 2.54W for stereo operation.

$$P_{DMAX} = 4 * (V_{DD})^2 / (2\pi^2 R_L) \quad \text{Bridge Mode} \quad (3)$$

The LM4883SQ's power dissipation is twice that given by Equation (2) or Equation (3) when operating in the single-ended mode or bridge mode, respectively. Twice the maximum power dissipation point given by Equation (3) must not exceed the power dissipation given by Equation (4):

$$P_{DMAX}' = (T_{JMAX} - T_A) / \theta_{JA} \quad (4)$$

The LM4883's  $T_{JMAX} = 150^\circ\text{C}$ . In the SQ package soldered to a DAP pad that expands to a copper area of 5in<sup>2</sup> on a

## Application Information (Continued)

PCB, the LM4883SQ's  $\theta_{JA}$  is 20°C/W. At any given ambient temperature  $T_A$ , use Equation (4) to find the maximum internal power dissipation supported by the IC packaging. Rearranging Equation (4) and substituting  $P_{D_{MAX}}$  for  $P_{D_{MAX}}$  results in Equation (5). This equation gives the maximum ambient temperature that still allows maximum stereo power dissipation without violating the LM4883's maximum junction temperature.

$$T_A = T_{J_{MAX}} - 2 * P_{D_{MAX}} \theta_{JA} \quad (5)$$

For a typical application with a 5V power supply and an 4Ω load, the maximum ambient temperature that allows maximum stereo power dissipation without exceeding the maximum junction temperature is approximately 99°C for the SQ package.

$$T_{J_{MAX}} = P_{D_{MAX}} \theta_{JA} + T_A \quad (6)$$

Equation (6) gives the maximum junction temperature  $T_{J_{MAX}}$ . If the result violates the LM4883's 150°C, reduce the maximum junction temperature by reducing the power supply voltage or increasing the load resistance. Further allowance should be made for increased ambient temperatures.

The above examples assume that a device is a surface mount part operating around the maximum power dissipation point. Since internal power dissipation is a function of output power, higher ambient temperatures are allowed as output power or duty cycle decreases.

If the result of Equation (2) is greater than that of Equation (3), then decrease the supply voltage, increase the load impedance, or reduce the ambient temperature. If these measures are insufficient, a heat sink can be added to reduce  $\theta_{JA}$ . The heat sink can be created using additional copper area around the package, with connections to the ground pin(s), supply pin and amplifier output pins. External, solder attached SMT heatsinks such as the Thermalloy 7106D can also improve power dissipation. When adding a heat sink, the  $\theta_{JA}$  is the sum of  $\theta_{JC}$ ,  $\theta_{CS}$ , and  $\theta_{SA}$ . ( $\theta_{JC}$  is the junction-to-case thermal impedance,  $\theta_{CS}$  is the case-to-sink thermal impedance, and  $\theta_{SA}$  is the sink-to-ambient thermal impedance.) Refer to the **Typical Performance Characteristics** curves for power dissipation information at lower output power levels.

### POWER SUPPLY BYPASSING

As with any power amplifier, proper supply bypassing is critical for low noise performance and high power supply rejection. Applications that employ a 5V regulator typically

use a 10 μF in parallel with a 0.1 μF filter capacitor to stabilize the regulator's output, reduce noise on the supply line, and improve the supply's transient response. However, their presence does not eliminate the need for a local 1.0 μF tantalum bypass capacitance connected between the LM4883's supply pins and ground. Do not substitute a ceramic capacitor for the tantalum. Doing so may cause oscillation. Keep the length of leads and traces that connect capacitors between the LM4883SQ's power supply pin and ground as short as possible. Connecting a 1μF capacitor,  $C_5$ , between the BYPASS pin and ground improves the internal bias voltage's stability and improves the amplifier's PSRR. The PSRR improvements increase as the bypass pin capacitor value increases. Too large, however, increases turn-on time and can compromise amplifier's click and pop performance. The selection of bypass capacitor values, especially  $C_5$ , depends on desired PSRR requirements, click and pop performance (as explained in the section, **Selecting Proper External Components**), system cost, and size constraints.

### MICRO-POWER SHUTDOWN

The voltage applied to the SHUTDOWN pin controls the LM4883's shutdown function. Activate micro-power shutdown by applying  $V_{DD}$  to the SHUTDOWN pin. When active, the LM4883's micro-power shutdown feature turns off the amplifier's bias circuitry, reducing the supply current. The logic threshold is typically  $V_{DD}/2$ . The low 0.04 μA typical shutdown current is achieved by applying a voltage that is as near as  $V_{DD}$  as possible to the SHUTDOWN pin. A voltage that is less than  $V_{DD}$  may increase the shutdown current. *Table 1* shows the logic signal levels that activate and deactivate micro-power shutdown and headphone amplifier operation.

There are a few ways to control the micro-power shutdown. These include using a single-pole, single-throw switch, a microprocessor, or a microcontroller. When using a switch, connect an external 10kΩ pull-up resistor between the SHUTDOWN pin and  $V_{DD}$ . Connect the switch between the SHUTDOWN pin and ground. Select normal amplifier operation by closing the switch. Opening the switch connects the SHUTDOWN pin to  $V_{DD}$  through the pull-up resistor, activating micro-power shutdown. The switch and resistor guarantee that the SHUTDOWN pin will not float. This prevents unwanted state changes. In a system with a microprocessor or a microcontroller, use a digital output to apply the control voltage to the SHUTDOWN pin. Driving the SHUTDOWN pin with active circuitry eliminates the pull up resistor.

TABLE 1. Logic Level Truth Table for SHUTDOWN, HP-IN, and MUX Operation

SHUTDOWN PIN	HP-INPIN	MUX CHANNEL SELECT PIN	OPERATIONAL MODE (MUX INPUT CHANNEL #)
Logic Low	Logic Low	Logic Low	Bridged Amplifiers (1)
Logic Low	Logic Low	Logic High	Bridged Amplifiers (2)
Logic Low	Logic High	Logic Low	Single-Ended Amplifiers (1)
Logic Low	Logic High	Logic High	Single-Ended Amplifiers (2)
Logic High	X	X	Micro-Power Shutdown

### HP-IN FUNCTION

Applying a voltage between 4V and  $V_{DD}$  to the LM4883's HP-IN headphone control pin turns off Amp A (+out) and Amp B (+out) muting a bridged-connected load. Quiescent current consumption is reduced when the IC is in this single-ended mode.

*Figure 4* shows the implementation of the LM4883's headphone control function. With no headphones connected to the headphone jack, the R9-R10 voltage divider sets the voltage applied to the HP-IN pin (pin 20) at approximately 50mV. This 50mV enables Amp A (+out) and Amp B (+out)



## Application Information (Continued)

placing the LM4883 in bridged mode operation. The output coupling capacitor blocks the amplifier's half supply DC voltage, protecting the headphones.

The HP-IN threshold is set at 4V. While the LM4883 operates in bridged mode, the DC potential across the load is essentially 0V. Therefore, even in an ideal situation, the output swing cannot cause a false single-ended trigger. Connecting headphones to the headphone jack disconnects the headphone jack contact pin from -OUTA and allows R1 to pull the HP Sense pin up to  $V_{DD}$ . This enables the headphone function, turns off Amp A (+out) and Amp B (+out) which mutes the bridged speaker. The amplifier then drives the headphones, whose impedance is in parallel with resistors R11 and R12. These resistors have negligible effect on the LM4883's output drive capability since the typical impedance of headphones is  $32\Omega$ .

Figure 4 also shows the suggested headphone jack electrical connections. The jack is designed to mate with a three-wire plug. The plug's tip and ring should each carry one of the two stereo output signals, whereas the sleeve should carry the ground return. A headphone jack with one control pin contact is sufficient to drive the HP-IN pin when connecting headphones.

A microprocessor or a switch can replace the headphone jack contact pin. When a microprocessor or switch applies a voltage greater than 4V to the HP-IN pin, a bridge-connected speaker is muted and Amp A (-out) and Amp B (-out) drive a pair of headphones.

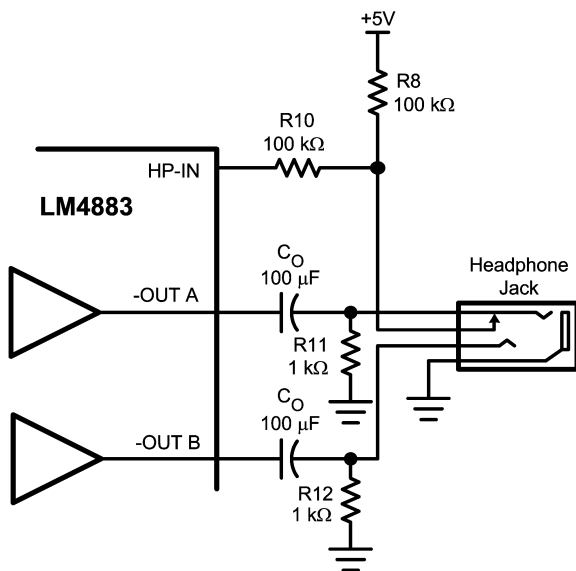

20088724

FIGURE 4. Headphone Circuit

### SELECTING PROPER EXTERNAL COMPONENTS

Optimizing the LM4883's performance requires properly selecting external components. Though the LM4883 operates well when using external components with wide tolerances, best performance is achieved by optimizing component values.

The LM4883 is unity-gain stable, giving a designer maximum design flexibility. The gain should be set to no more than a given application requires. This allows the amplifier to

achieve minimum THD+N and maximum signal-to-noise ratio. These parameters are compromised as the closed-loop gain increases. However, low gain demands input signals with greater voltage swings to achieve maximum output power. Fortunately, many signal sources such as audio CODECs have outputs of  $1V_{RMS}$  ( $2.83V_{P-P}$ ). Please refer to the **Audio Power Amplifier Design** section for more information on selecting the proper gain.

### Input Capacitor Value Selection

Amplifying the lowest audio frequencies requires high value input coupling capacitors (C1–4) in Figures 1, 3. A high value capacitor can be expensive and may compromise space efficiency in portable designs. In many cases, however, the speakers used in portable systems, whether internal or external, have little ability to reproduce signals below 150 Hz. Applications using speakers with this limited frequency response reap little improvement by using large input capacitor.

Besides effecting system cost and size, C1–4 have an effect on the LM4883's click and pop performance. When the supply voltage is first applied, a transient (pop) is created as the charge on the input capacitor changes from zero to a quiescent state. The magnitude of the pop is directly proportional to the input capacitor's size. Higher value capacitors need more time to reach a quiescent DC voltage (usually  $V_{DD}/2$ ) when charged with a fixed current. The amplifier's output charges the input capacitor through the feedback resistors, R2,3,7, and 8. Thus, pops can be minimized by selecting an input capacitor value that is no higher than necessary to meet the desired -3dB frequency.

As shown in Figure 3, the input resistors (R1,4,5, and 6) and the input capacitors, C1–4 produce a -3dB high pass filter cutoff frequency that is found using Equation (7).

$$f_{-3dB} = \frac{1}{2\pi R_{IN} C_{IN}} = \frac{1}{2\pi R1 C1} \quad (7)$$

As an example when using a speaker with a low frequency limit of 150Hz,  $C_1$ , using Equation (7) is  $0.053\mu F$ . The  $.33\mu F$   $C_1$  shown in Figure 3 allows the LM4883 to drive high efficiency, full range speaker whose response extends below 30Hz.

### Bypass Capacitor Value Selection

Besides minimizing the input capacitor size, careful consideration should be paid to value of  $C_5$ , the capacitor connected to the BYPASS pin. Since  $C_5$  determines how fast the LM4883 settles to quiescent operation, its value is critical when minimizing turn-on pops. The slower the LM4883's outputs ramp to their quiescent DC voltage (nominally  $1/2 V_{DD}$ ), the smaller the turn-on pop. Choosing  $C_5$  equal to  $1.0\mu F$  along with a small value of  $C_1$  (in the range of  $0.1\mu F$  to  $0.39\mu F$ ), produces a click-less and pop-less shutdown function. As discussed above, choosing  $C_1$  no larger than necessary for the desired bandwidth helps minimize clicks and pops.

### OPTIMIZING CLICK AND POP REDUCTION PERFORMANCE

The LM4883 contains circuitry that minimizes turn-on and shutdown transients or "clicks and pop". For this discussion, turn-on refers to either applying the power supply voltage or when the shutdown mode is deactivated. While the power supply is ramping to its final value, the LM4883's internal amplifiers are configured as unity gain buffers. An internal

## Application Information (Continued)

current source changes the voltage of the BYPASS pin in a controlled, linear manner. Ideally, the input and outputs track the voltage applied to the BYPASS pin. The gain of the internal amplifiers remains unity until the voltage on the bypass pin reaches  $1/2 V_{DD}$ . As soon as the voltage on the bypass pin is stable, the device becomes fully operational. Although the BYPASS pin current cannot be modified, changing the size of  $C_5$  alters the device's turn-on time and the magnitude of "clicks and pops". Increasing the value of  $C_5$  reduces the magnitude of turn-on pops. However, this presents a tradeoff: as the size of  $C_5$  increases, the turn-on time increases. There is a linear relationship between the size of  $C_5$  and the turn-on time. Here are some typical turn-on times for various values of  $C_5$ :

$C_5$	$T_{ON}$
0.01 $\mu$ F	30ms
0.1 $\mu$ F	40ms
0.22 $\mu$ F	60ms
0.47 $\mu$ F	80ms
1.0 $\mu$ F	140 ms

In order eliminate "clicks and pops", all capacitors must be discharged before turn-on. Rapidly switching  $V_{DD}$  may not allow the capacitors to fully discharge, which may cause "clicks and pops". In a single-ended configuration, the output is coupled to the load by C7,8. These capacitors usually have a high value. C7,8 discharges through internal 20k $\Omega$  resistors. Depending on the size of C7,8, the discharge time constant can be relatively large. To reduce transients in single-ended mode, an external 1k $\Omega$ –5k $\Omega$  resistor can be placed in parallel with the internal 20k $\Omega$  resistor. The tradeoff for using this resistor is increased quiescent current.

### NO LOAD STABILITY

The LM4883 may exhibit low level oscillation when the load resistance is greater than 10k $\Omega$ . This oscillation only occurs as the output signal swings near the supply voltages. Prevent this oscillation by connecting a 5k $\Omega$  between the output pins and ground.

### AUDIO POWER AMPLIFIER DESIGN

#### Audio Amplifier Design: Driving 1W into an 8 $\Omega$ Load

The following are the desired operational parameters:

Power Output:	1W <sub>RMS</sub>
Load Impedance:	8 $\Omega$
Input Level:	1V <sub>rms</sub>
Input Impedance:	20k $\Omega$
Bandwidth:	100Hz–20kHz $\pm$ 0.25dB

The design begins by specifying the minimum supply voltage necessary to obtain the specified output power. One way to find the minimum supply voltage is to use the Output Power vs Supply Voltage curve in the **Typical Performance Characteristics** section. Another way, using Equation (8), is to calculate the peak output voltage necessary to achieve the desired output power for a given load impedance. To account for the amplifier's dropout voltage, two additional voltages, based on the Dropout Voltage vs Supply Voltage in the

**Typical Performance Characteristics** curves, must be added to the result obtained by Equation (8). The result in Equation (9).

$$V_{OUTPEAK} = \sqrt{(2R_L P_O)} \quad (8)$$

$$V_{DD} \geq (V_{OUTPEAK} + (V_{ODTOP} + V_{ODBOT})) \quad (9)$$

The Output Power vs Supply Voltage graph for an 8 $\Omega$  load indicates a minimum supply voltage of 4.6V. This is easily met by the commonly used 5V supply voltage. The additional voltage creates the benefit of headroom, allowing the LM4883 to produce peak output power in excess of 1W without clipping or other audible distortion. The choice of supply voltage must also not create a situation that violates maximum power dissipation as explained above in the **Power Dissipation** section.

After satisfying the LM4883's power dissipation requirements, the minimum differential gain needed to achieve 1W dissipation in an 8 $\Omega$  load is found using Equation (10).

$$A_{VD} \geq \sqrt{(P_O R_L)} / (V_{IN}) = V_{orms} / V_{inrms} \quad (10)$$

Thus, a minimum gain of 2.83 allows the LM4883's to reach full output swing and maintain low noise and THD+N performance. For this example, let  $A_{VD} = 3$ .

The amplifier's overall gain is set using the input ( $R_1$ ) and feedback ( $R_3$ ) resistors. With the desired input impedance set at 20k $\Omega$ , the feedback resistor is found using Equation (11).

$$R_3 / R_1 = A_{VD} / 2 \quad (11)$$

The value of  $R_f$  is 30k $\Omega$ .

The last step in this design example is setting the amplifier's –3dB frequency bandwidth. To achieve the desired  $\pm 0.25$ dB pass band magnitude variation limit, the low frequency response must extend to at least one-fifth the lower bandwidth limit and the high frequency response must extend to at least five times the upper bandwidth limit. The gain variation for both response limits is 0.17dB, well within the  $\pm 0.25$ dB desired limit. The results are an

$$f_L = 100\text{Hz} / 5 = 20\text{Hz}$$

and an

$$f_H = 20\text{kHz} * 5 = 100\text{kHz}.$$

As mentioned in the **External Components** section,  $R_1$  and  $C_1$  create a highpass filter that sets the amplifier's lower bandpass frequency limit. Find the coupling capacitor's value using Equation (12).

$$C_1 \geq 1 / (2\pi R_1 f_L) \quad (12)$$

The result is

$$1 / (2\pi * 20\text{k}\Omega * 20\text{Hz}) = 0.398\mu\text{F}.$$

Use a 0.39 $\mu$ F capacitor, the closest standard value.

The product of the desired high frequency cutoff (100kHz in this example) and the differential gain,  $A_{VD}$ , determines the upper passband response limit. With  $A_{VD} = 3$  and  $f_H = 100\text{kHz}$ , the closed-loop gain bandwidth product (GBWP) is 300kHz. This is less than the LM4883's 3.5MHz GBWP. With this margin, the amplifier can be used in designs that require more differential gain while avoiding performance-restricting bandwidth limitations.

## Application Information (Continued)

### RECOMMENDED PRINTED CIRCUIT BOARD LAYOUT

Figures 5 through 7 show the recommended two-layer PC board layout that is optimized for the 24-pin SQ package. These circuits are designed for use with an external 5V supply and 8 $\Omega$ , 4 $\Omega$ , 3 $\Omega$  speakers.

These circuit boards are easy to use. Apply 5V and ground to the board's  $V_{DD}$  and GND pads, respectively. Connect the speakers between the board's -OUTA and +OUTA and OUTB and +OUTB pads.

# Demonstration Board Layout

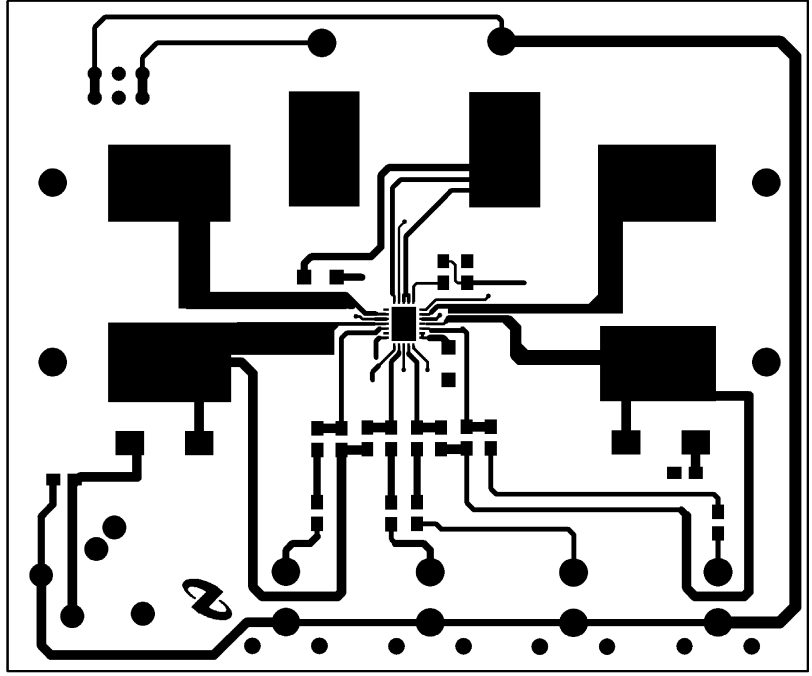

20088727

FIGURE 5. Top Layer

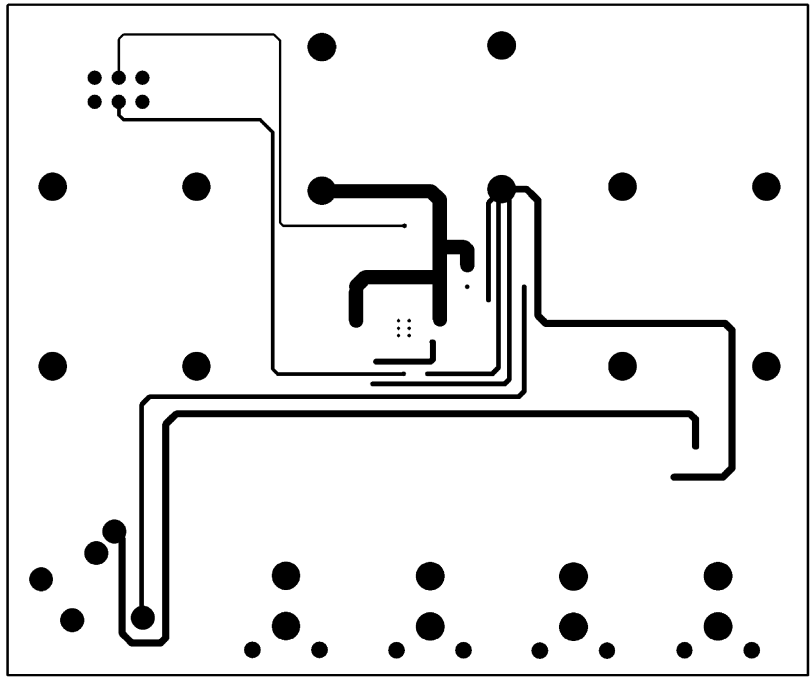

20088725

FIGURE 6. Bottom Layer

Demonstration Board Layout (Continued)

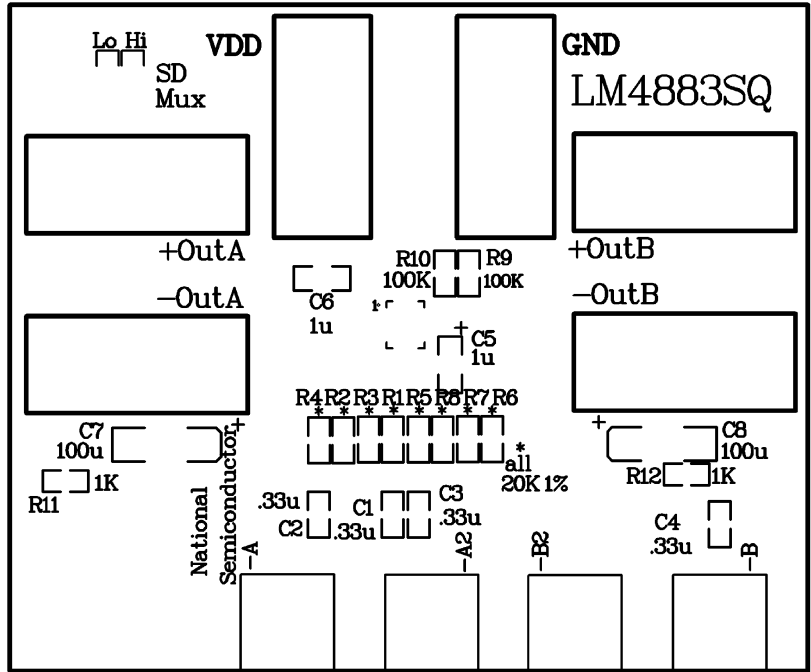

20088726

FIGURE 7. Silkscreen

## Bill of Materials

Analog Audio LM4883SQ Eval Board

Assembly Part Number: 551012279-001

Revision: A

Item	Part Number	Part Description	Qty	Ref Designator	Remark
1	551012279-001	LM4883SQ Eval Board PCB etch 001	1		
2		IC LM4883SQ	1	U1	
3		Tant Cap 0.33 $\mu$ F 50V 10%	4	C1-C4	
4		Tant Cap 1 $\mu$ F 16V 10% Size = A 3216	2	C5, C6	
5		Tant Cap 100 $\mu$ F 16V 10% Size = D 7343	2	C7, C8	
6		Res 1k $\Omega$ 1/8W 1% 0805	2	R11, R12	
7		Res 20k $\Omega$ 1/8W 1% 0805	8	R1-R8	
8		Res 100k $\Omega$ 1/8W 1% 0805	2	R9, R10	
9		RCA Jack	4	-A, -A2, -B, -B2	Mouser # 16PJ097
10		Banana Jack, Black	3	-OutA, - OutB, GND	Mouser # ME164-6218
11		Banana Jack, Red	3	+OutA, + OutB, VDD	Mouser # ME164-6219
12		Jumper Header 3 x 1	2	SD, MUX	

**Physical Dimensions** inches (millimeters) unless otherwise noted

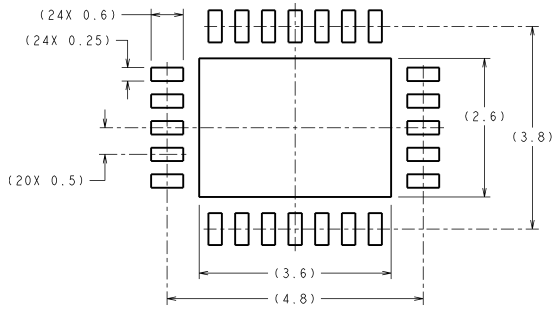

DIMENSIONS ARE IN MILLIMETERS  
DIMENSIONS IN ( ) FOR REFERENCE ONLY

**RECOMMENDED LAND PATTERN**

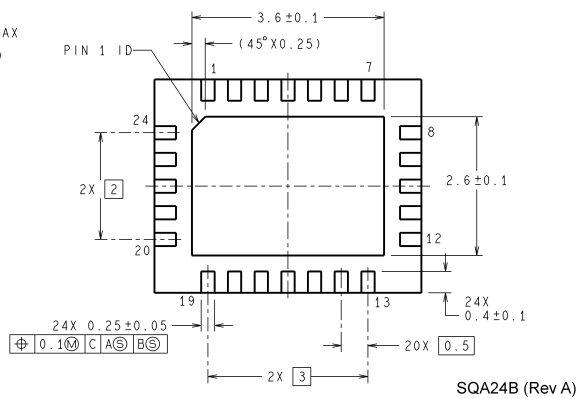
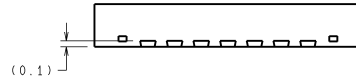
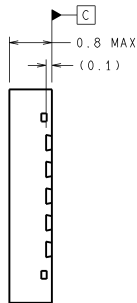
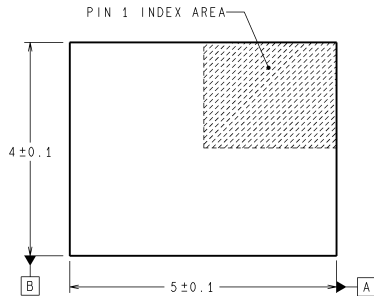

**LLP Package**  
**Order Number LM4883SQ**  
**NS Package Number SQA24B**

National does not assume any responsibility for use of any circuitry described, no circuit patent licenses are implied and National reserves the right at any time without notice to change said circuitry and specifications.

For the most current product information visit us at [www.national.com](http://www.national.com).

**LIFE SUPPORT POLICY**

NATIONAL'S PRODUCTS ARE NOT AUTHORIZED FOR USE AS CRITICAL COMPONENTS IN LIFE SUPPORT DEVICES OR SYSTEMS WITHOUT THE EXPRESS WRITTEN APPROVAL OF THE PRESIDENT AND GENERAL COUNSEL OF NATIONAL SEMICONDUCTOR CORPORATION. As used herein:

1. Life support devices or systems are devices or systems which, (a) are intended for surgical implant into the body, or (b) support or sustain life, and whose failure to perform when properly used in accordance with instructions for use provided in the labeling, can be reasonably expected to result in a significant injury to the user.
2. A critical component is any component of a life support device or system whose failure to perform can be reasonably expected to cause the failure of the life support device or system, or to affect its safety or effectiveness.

**BANNED SUBSTANCE COMPLIANCE**

National Semiconductor certifies that the products and packing materials meet the provisions of the Customer Products Stewardship Specification (CSP-9-111C2) and the Banned Substances and Materials of Interest Specification (CSP-9-111S2) and contain no "Banned Substances" as defined in CSP-9-111S2.



**National Semiconductor**  
**Americas Customer Support Center**  
Email: [new.feedback@nsc.com](mailto:new.feedback@nsc.com)  
Tel: 1-800-272-9959

**National Semiconductor**  
**Europe Customer Support Center**  
Fax: +49 (0) 180-530 85 86  
Email: [europa.support@nsc.com](mailto:europa.support@nsc.com)  
Deutsch Tel: +49 (0) 69 9508 6208  
English Tel: +44 (0) 870 24 0 2171  
Français Tel: +33 (0) 1 41 91 8790

**National Semiconductor**  
**Asia Pacific Customer Support Center**  
Email: [ap.support@nsc.com](mailto:ap.support@nsc.com)

**National Semiconductor**  
**Japan Customer Support Center**  
Fax: 81-3-5639-7507  
Email: [jpn.feedback@nsc.com](mailto:jpn.feedback@nsc.com)  
Tel: 81-3-5639-7560

[www.national.com](http://www.national.com)