



# LM4880

CMOS IC

## DUAL 250mW AUDIO POWER AMPLIFIER WITH SHUTDOWN MODE

### DESCRIPTION

The UTC LM4880 is a dual audio power amplifier capable of delivering typically 250mW per channel of continuous average power to an 8Ω load with 0.1% THD+N using a 5V power supply.

The UTC LM4880 features an externally controlled, low-power consumption shutdown mode, as well as an internal thermal shutdown protection mechanism.

The unity-gain stable UTC LM4880 can be configured by external gain-setting resistors.

### FEATURES

- \* No bootstrap capacitors or snubber circuits are necessary
- \* Unity-gain stable
- \* External gain configuration capability

### APPLICATIONS

- \* Personal Computers
- \* CD-ROM Players
- \* Headphone Amplifier

### ORDERING INFORMATION

Ordering Number		Package	Packing
Normal	Lead Free Plating		
LM4880-D08-T	LM4880L-D08-T	DIP-8	Tube
LM4880-SH2-R	LM4880L-SH2-R	HSOP-8	Tape Reel
LM4880-SH2-T	LM4880L-SH2-T	HSOP-8	Tube

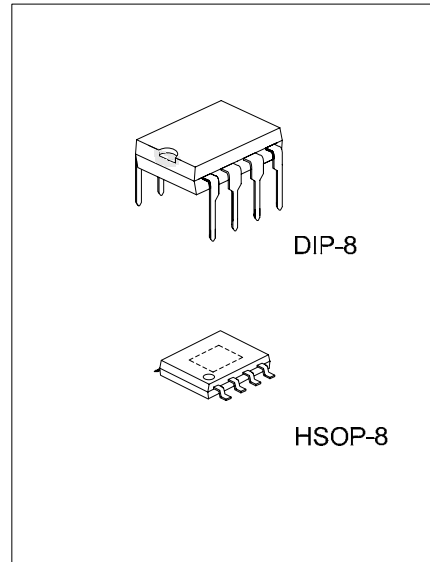

\*Pb-free plating product number: LM4880L

<p>LM4880L-D08-T</p> <p>(1)Packing Type (2)Package Type (3)Lead Plating</p>	<p>(1) R: Tape Reel, T: Tube (2) D08: DIP-8, SH2: HSOP-8 (3) L: Lead Free Plating, Blank: Pb/Sn</p>
---	---

■ PIN CONFIGURATION

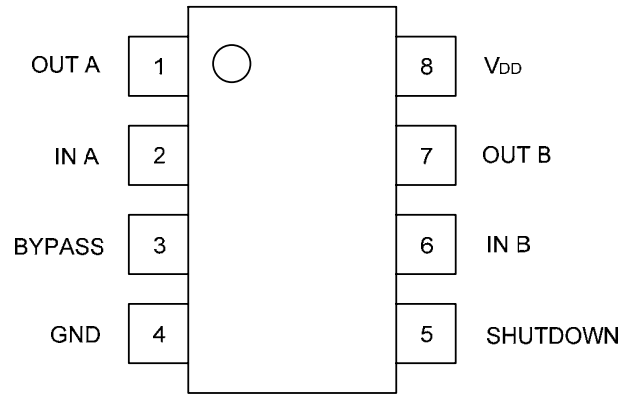

■ PIN DESCRIPTION

PIN NO	PIN NAME	I/O	DESCRIPTION
1	OUT A	O	Channel A output
2	IN A	I	Channel A audio input
3	BYPASS	I	Connect to internal voltage divider for middle supply bias
4	GND		Ground
5	SHUTDOWN	I	Shutdown mode control input, high active, place LM4880 into shutdown mode, when held high
6	IN B	I	Channel B audio input
7	OUT B	O	Channel B output
8	V <sub>DD</sub>		Supply voltage

### ■ ABSOLUTE MAXIMUM RATINGS (Note 2)

PARAMETER	SYMBOL	RATINGS	UNIT
Supply Voltage	$V_{DD}$	6.0	V
Input Voltage	$V_{IN}$	$-0.3 \sim V_{DD}+0.3$	V
ESD Susceptibility (Note 3)	ESD	3500	V
ESD Susceptibility (Note 4)		250	V
Power Dissipation (Note 5)	$P_D$	Internally limited	
Junction Temperature	$T_J$	150	°C
Operating Temperature	$T_{OPR}$	$-40 \sim +85$	°C
Storage Temperature	$T_{STG}$	$-65 \sim +150$	°C

Note Absolute maximum ratings are those values beyond which the device could be permanently damaged.

Absolute maximum ratings are stress ratings only and functional device operation is not implied.

### ■ THERMAL DATA

PARAMETER	SYMBOL	RATINGS	UNIT
Thermal Resistance From Junction to Ambient	DIP-8	107	°C/W
	HSOP-8	42.3	
Thermal Resistance From Junction to Case	DIP-8	37	°C/W
	HSOP-8	12	

### ■ OPERATING RATINGS

PARAMETER	SYMBOL	RATINGS	UNIT
Supply Voltage	$V_{DD}$	$2.7 \sim 5.5$	V
Temperature Range ( $T_{MIN} \leq T_a \leq T_{MAX}$ )	$T_a$	$-40 \sim +85$	°C

### ■ ELECTRICAL CHARACTERISTICS (Note 1,2)

( $T_a=25^\circ\text{C}$ , The following specifications apply for  $V_{DD}=5\text{V}$ ,  $f=1\text{kHz}$  unless otherwise specified)

PARAMETER	SYMBOL	TEST CONDITIONS	MIN	TYP	MAX	UNIT
Supply Voltage	$V_{DD}$		2.7		5.5	V
Quiescent Power Supply Current	$I_{DD}$	$V_{IN}=0\text{V}$ , $I_{OUT}=0\text{A}$		3.6	6.0	mA
Shutdown Current	$I_{SHDN}$	$V_{PIN5}=V_{DD}$		0.7	5	μA
Output Offset Voltage	$V_{O(OFF)}$	$V_{IN}=0\text{V}$		5	50	mV
Output Power	$P_{OUT}$	THD=0.1%(max) f=1KHz	$R_L=8\Omega$	200	250	mW
			$R_L=32\Omega$		85	mW
		THD+N=10%, f=1KHz	$R_L=8\Omega$		325	mW
			$R_L=32\Omega$		110	mW
Total Harmonic Distortion + Noise	THD+N	$R_L=8\Omega$ , $P_{OUT}=200\text{mW}$ , $f=1\text{KHz}$		0.03		%
		$R_L=32\Omega$ , $P_{OUT}=75\text{mW}$ , $f=1\text{KHz}$		0.02		%
Power Supply Rejection Ratio	PSRR	$C_b=1.0\mu\text{F}$ $V_{RIPPLE}=200\text{mVrms}$ , $f=100\text{Hz}$		50		dB

Note 1: All voltages are measured with respect to the ground pin, unless otherwise specified.

Note 2: Absolute Maximum Ratings indicate limits beyond which damage may occur. Operating ratings indicate conditions for which the device is functional, but do not guarantee specific performance limits. Electrical Characteristics state DC and AC electrical specifications under particular test conditions which guarantee specific performance limits. This assumes that the device is within the operating ratings. Specifications are not guaranteed for parameters where no limit is given, however, the typical value is a good indication of device performance.

Note 3: Human body model, 100 pF discharged through a 1.5 kΩ resistor.

Note 4: Machine model, 220 pF ~ 240 pF discharged through all pins.

Note 5: The maximum power dissipation must be derated at elevated temperatures and is dictated by  $T_{JMAX}$ ,  $\theta_{JA}$ , and the ambient temperature  $T_A$ . The maximum allowable power dissipation is  $P_{DMAX} = (T_{JMAX} - T_A) / \theta_{JA}$  or the number given in the Absolute Maximum Ratings, whichever is lower. For the UTC LM4880,  $T_{JMAX} = 150^\circ\text{C}$ , and the typical junction-to-ambient thermal resistance is 170 °C/W for SOP-8 package and 107 °C/W for DIP-8 package.

■ TYPICAL APPLICATION

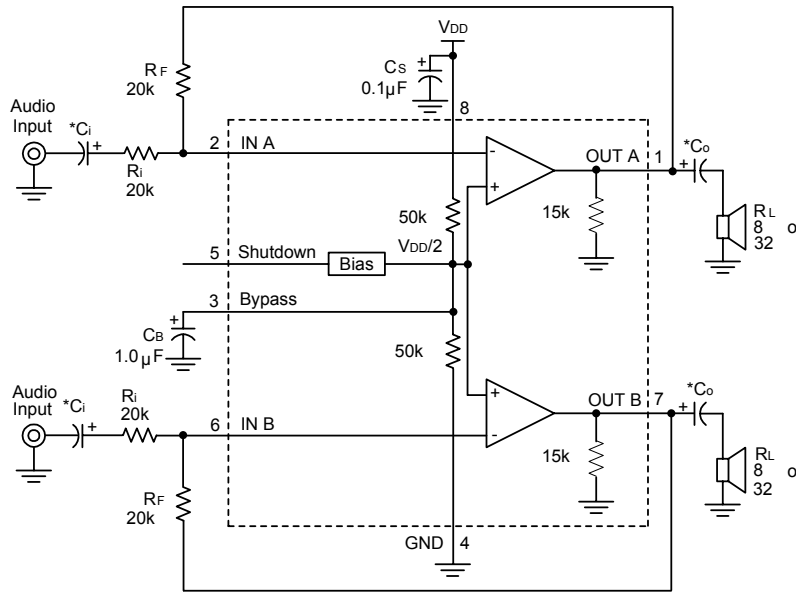

Figure 1. Typical Audio Amplifier Application Circuit

■ EXTERNAL COMPONENTS DESCRIPTION (Figure 1)

COMPONENTS		FUNCTIONAL DESCRIPTION
1.	R <sub>i</sub>	Inverting input resistance which sets the closed-loop gain in conjunction with R <sub>F</sub> . This resistor also forms a high pass filter with C <sub>i</sub> at $f_c = 1/(2 R_i C_i)$ .
2.	C <sub>i</sub>	Input coupling capacitor which blocks the DC voltage at the amplifier's input terminals. Also creates a high pass filter with R <sub>i</sub> at $f_c = 1/(2 R_i C_i)$ .
3.	R <sub>F</sub>	Feedback resistance which sets closed-loop gain in conjunction with R <sub>i</sub> .
4.	C <sub>s</sub>	Supply bypass capacitor which provides power supply filtering.
5.	C <sub>B</sub>	Bypass pin capacitor which provides half-supply filtering.
6.	C <sub>O</sub>	Output coupling capacitor which blocks the DC voltage at the amplifier's output. Forms a high pass filter with R <sub>L</sub> at $f_o = 1/(2 R_L C_o)$ .

■ AUTOMATIC SHUTDOWN CIRCUIT

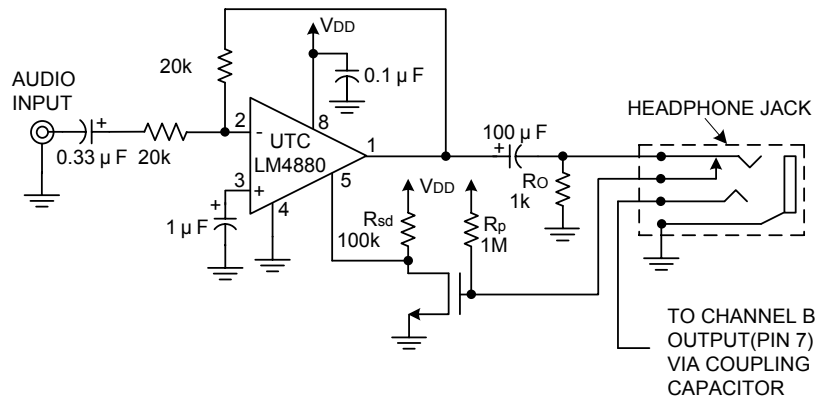

Figure 2. Automatic Shutdown Circuit

■ AUTOMATIC SWITCHING CIRCUIT

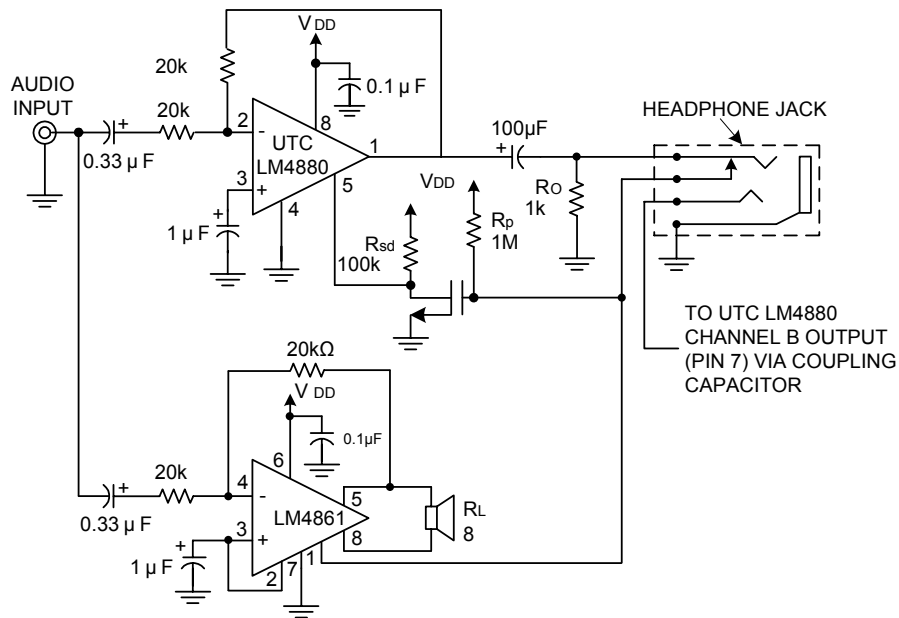
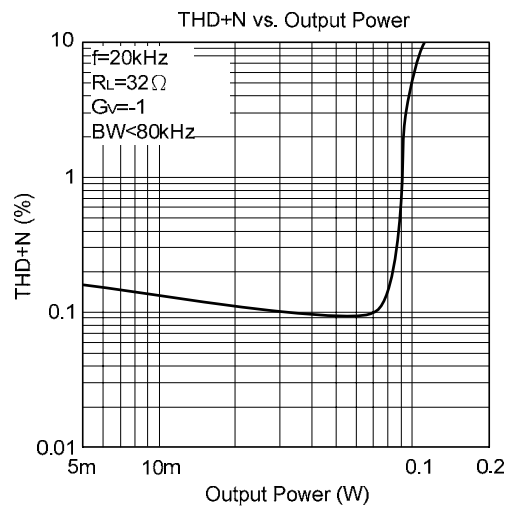
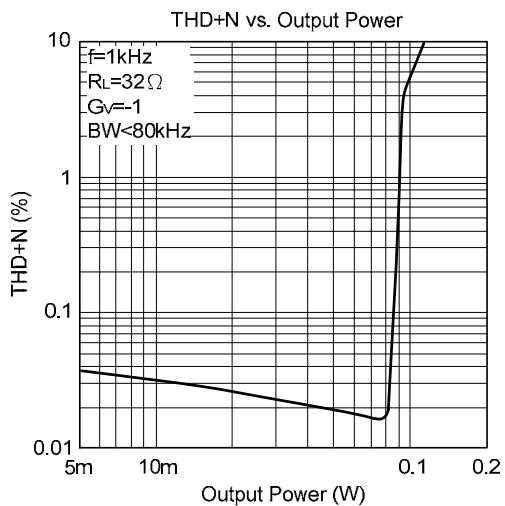
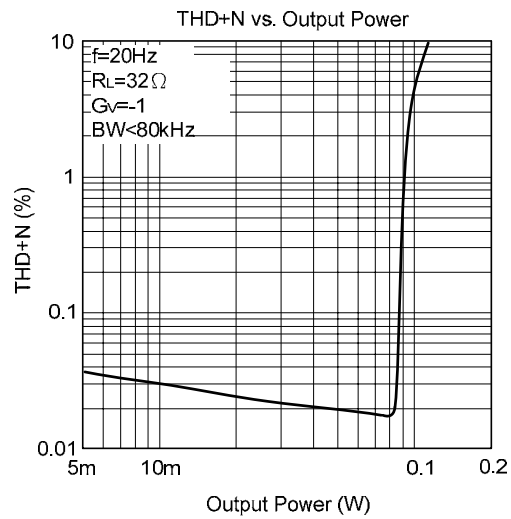
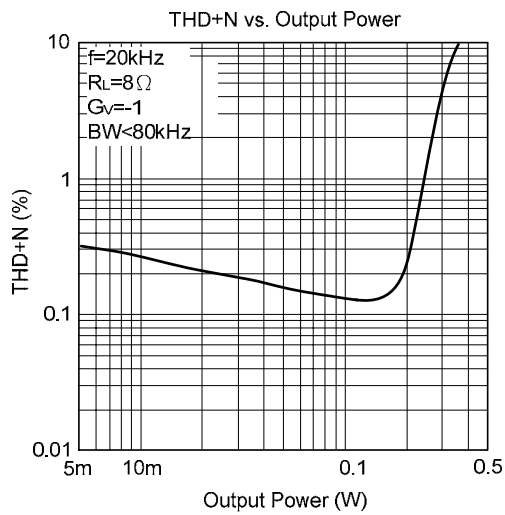
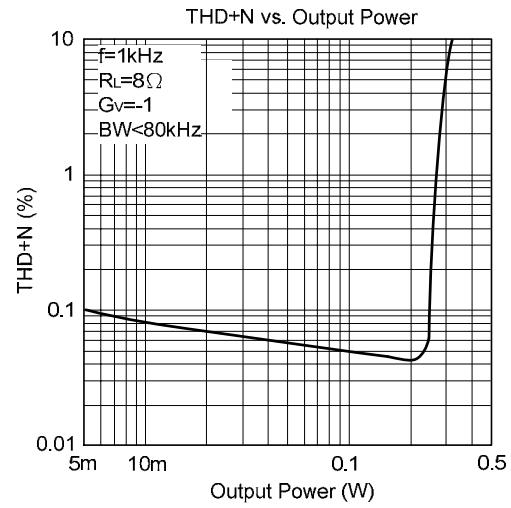
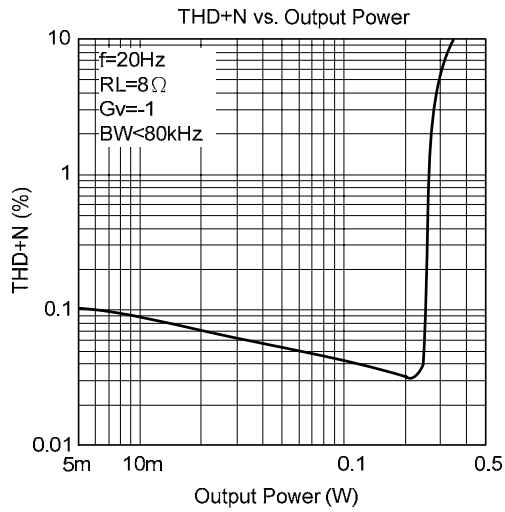
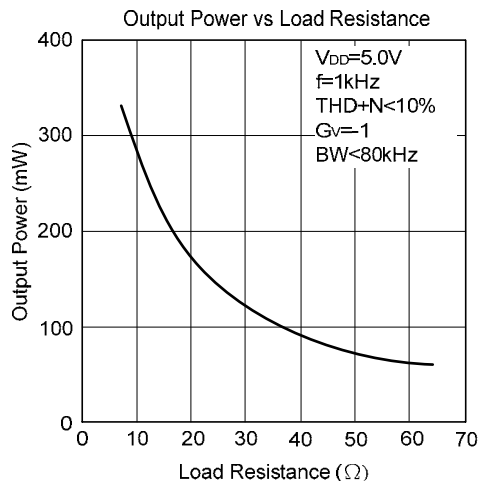
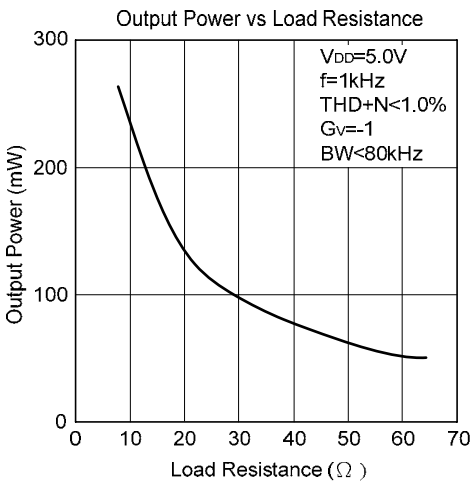
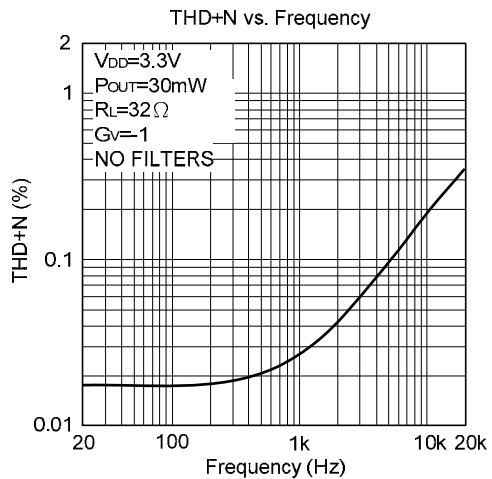
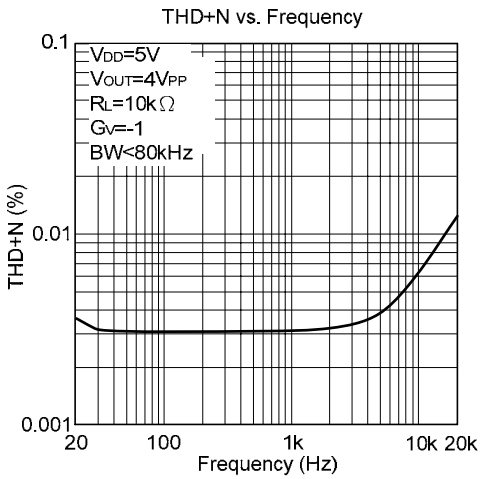
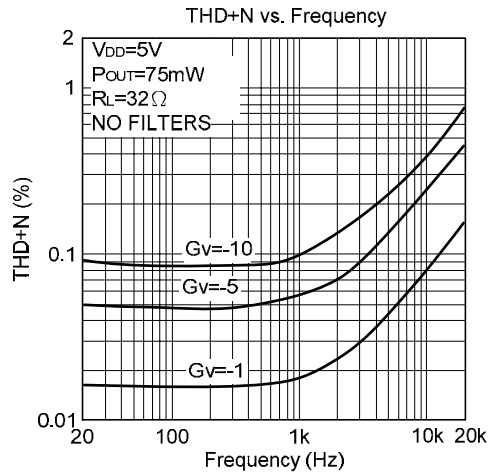
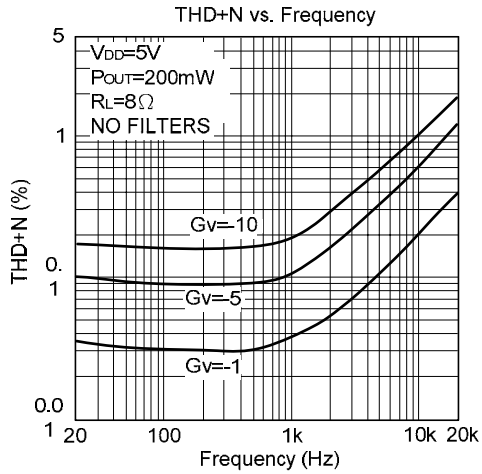

Figure 3. Automatic Switching Circuit

## TYPICAL CHARACTERISTICS



■ TYPICAL CHARACTERISTICS(Cont.)



## ■ TYPICAL CHARACTERISTICS(Cont.)

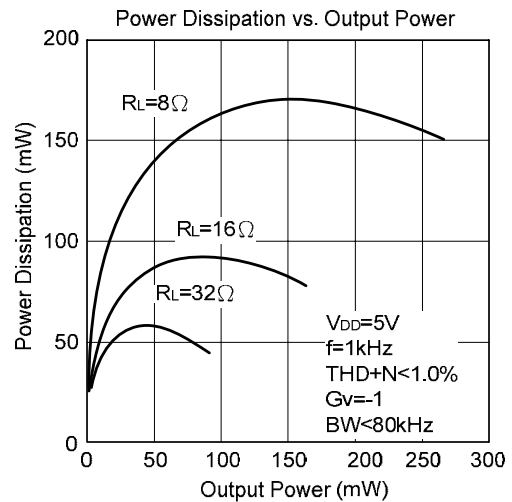
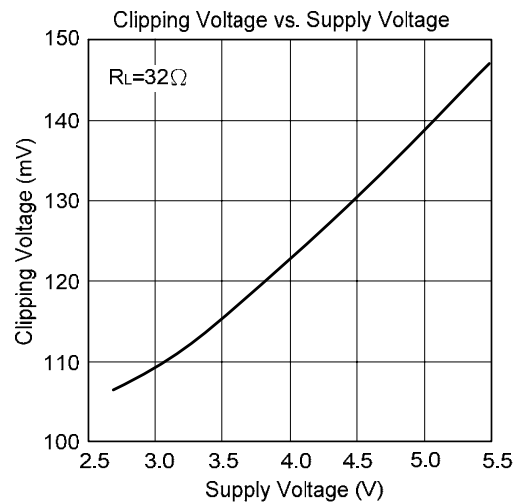
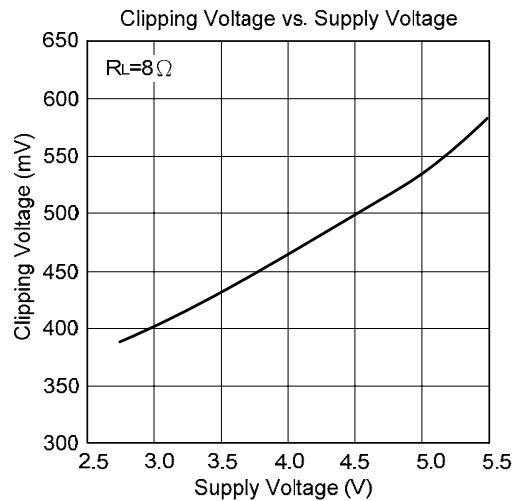
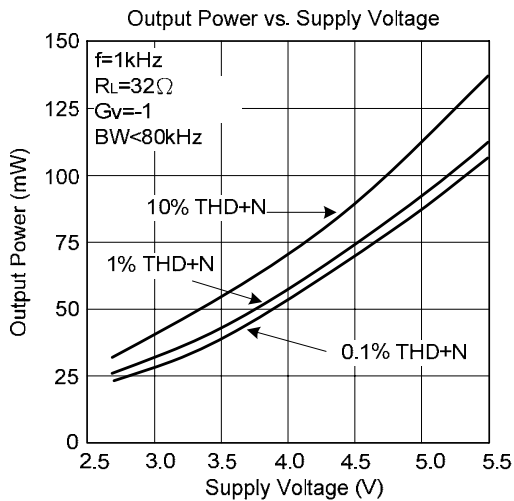
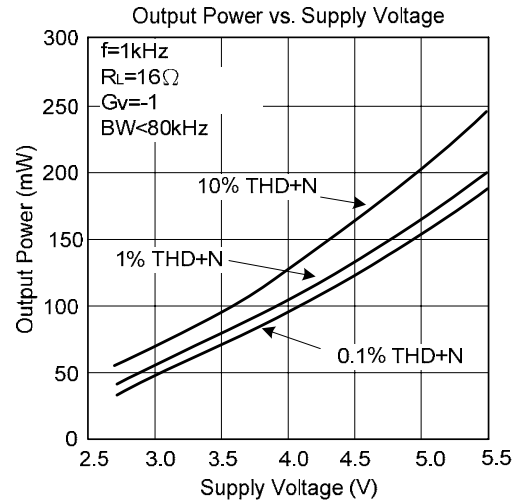
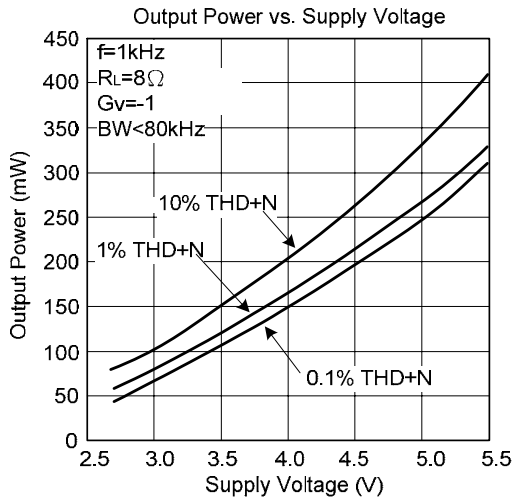



## TYPICAL CHARACTERISTICS(Cont.)

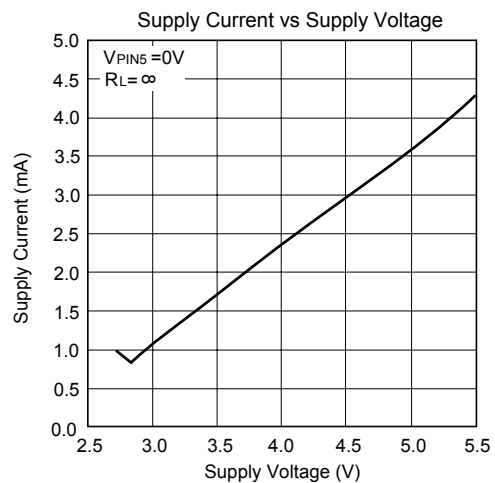
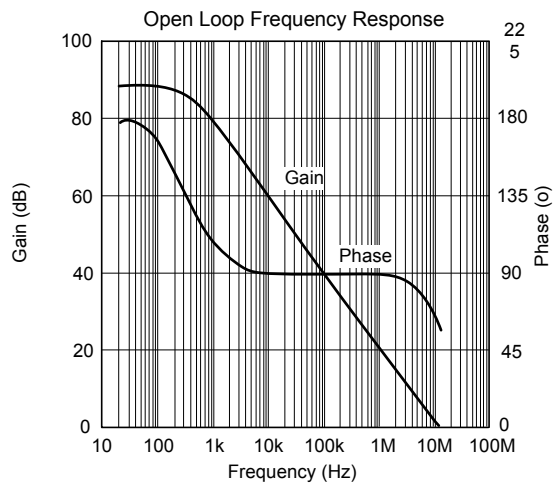
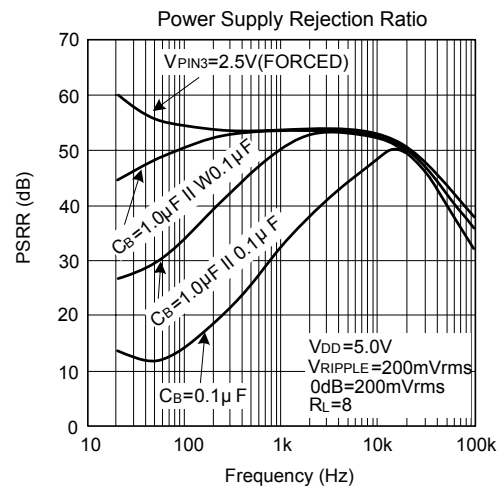
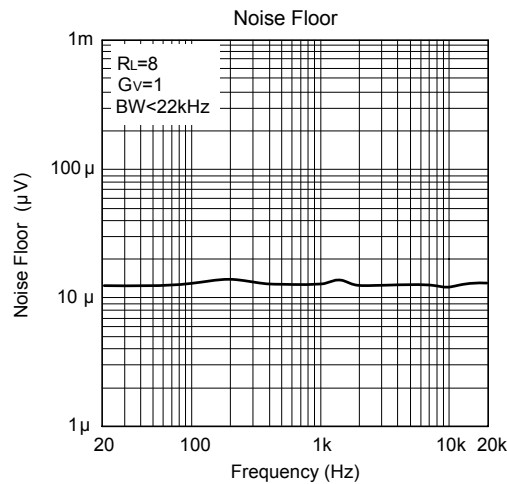
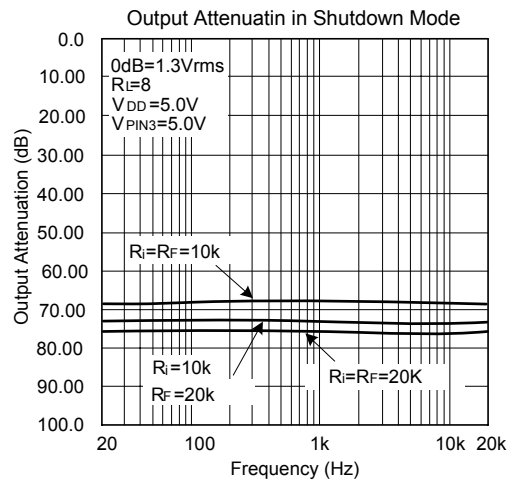
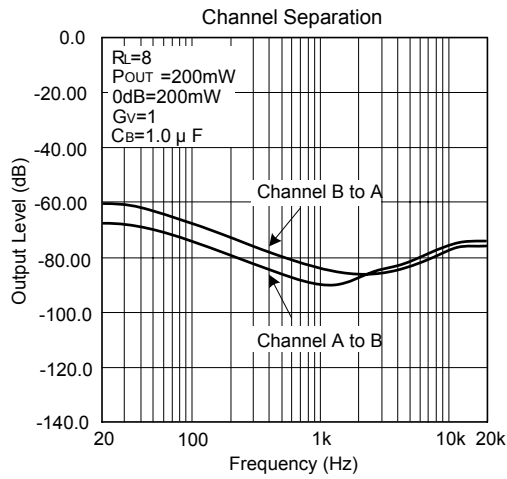

## ■ TYPICAL CHARACTERISTICS(Cont.)

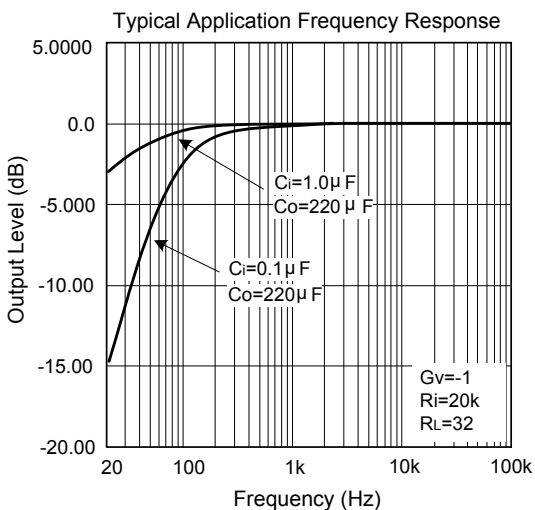
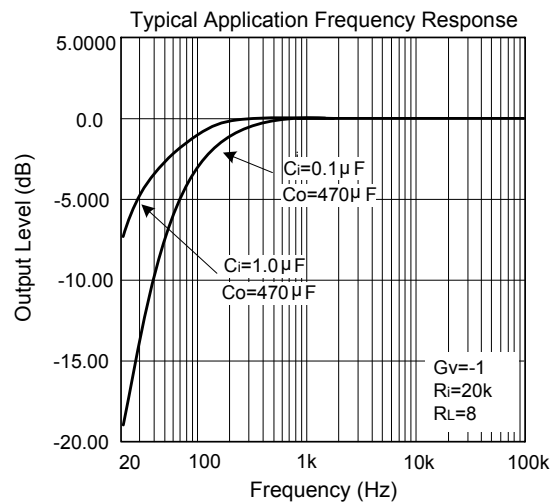
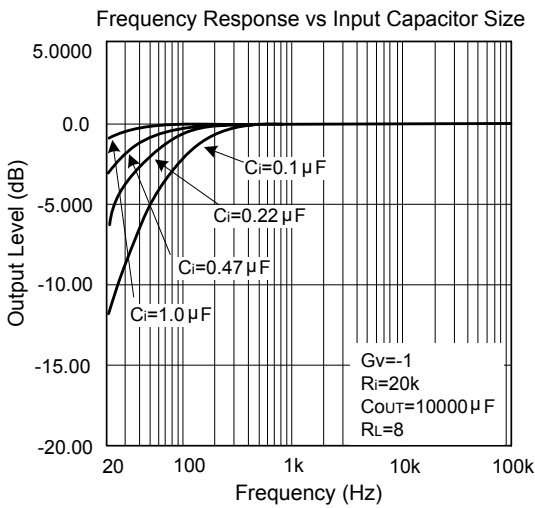
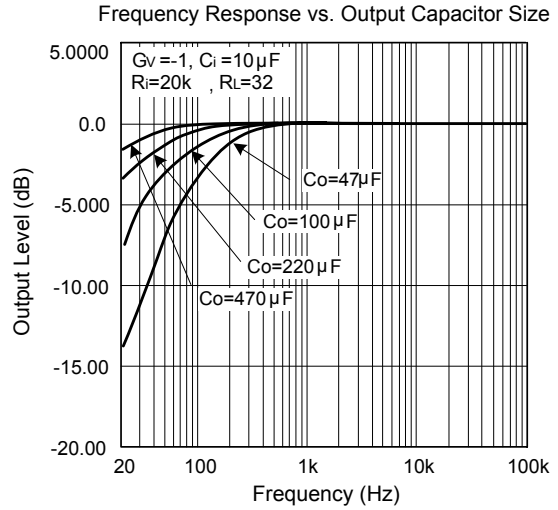
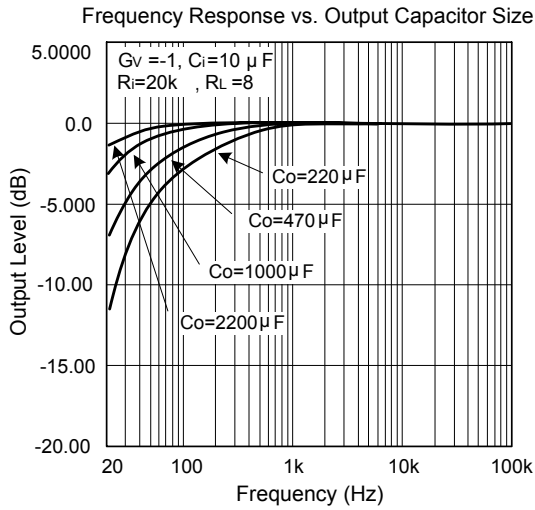

UTC assumes no responsibility for equipment failures that result from using products at values that exceed, even momentarily, rated values (such as maximum ratings, operating condition ranges, or other parameters) listed in products specifications of any and all UTC products described or contained herein. UTC products are not designed for use in life support appliances, devices or systems where malfunction of these products can be reasonably expected to result in personal injury. Reproduction in whole or in part is prohibited without the prior written consent of the copyright owner. The information presented in this document does not form part of any quotation or contract, is believed to be accurate and reliable and may be changed without notice.

