

Cree® P4 LED

Model # LP368PWN1-D0G

Data Sheet

130-degree, 7.6 x 7.6 mm LED lamp in white color with water-transparent lens and stopper

Applications

- Indicators
- Illuminations

Absolute Maximum Ratings ($T_A = 25^\circ\text{C}$)

Items	Symbol	Absolute Maximum Rating	Unit
Forward Current	I_F	30	mA
Peak Forward Current ^{Note}	I_{FP}	100	mA
Reverse Voltage	V_R	5	V
Power Dissipation	P_D	132	mW
Operation Temperature	T_{opr}	-40 ~ +95	°C
Storage Temperature	T_{stg}	-40 ~ +100	°C
Lead Soldering Temperature	T_{sol}	Max. 260°C for 3 sec. max. (3 mm from the base of the epoxy bulb)	

Note: Pulse width ≤ 0.1 msec, duty $\leq 1/10$.

Typical Electrical & Optical Characteristics ($T_A = 25^\circ\text{C}$)

Characteristics	Symbol	Condition	Unit	Minimum	Typical	Maximum
Forward Voltage	V_F	$I_F = 30$ mA	V		3.6	4.4
Reverse Current	I_R	$V_R = 5$ V	μA			100
Luminous Intensity	I_v	$I_F = 30$ mA	mcd	280	400	
Luminous Flux	Φ_v	$I_F = 30$ mA	mlm		1100	
Chromaticity Coordinates	x	$I_F = 30$ mA			0.31	
	y	$I_F = 30$ mA			0.32	
50% Power Angle	$2\theta_{1/2H-H}$	$I_F = 30$ mA	deg		130	

Standard Bins for LP368PWN1-D0G ($I_F = 30 \text{ mA}$)

Lamps are sorted to luminous intensity (I_V), V_F and chromaticity coordinates (x,y) bins shown.

Orders for LP368PWN1-D0G may be filled with any or all bins contained as below.

All luminous intensity (I_V), V_F and chromaticity coordinates (x,y) values shown and specified are at $I_F = 30 \text{ mA}$.

	A1	A2	B1	B2	c	
Luminous Intensity (I_V)	770 mcd					S or above
	550 mcd					R
	390 mcd					Q
	280 mcd					P
	Chromaticity Coordinates (x,y)					

Rank	A1				A2				B1				
Chromaticity Coordinates	x	0.245	0.264	0.280	0.264	0.264	0.283	0.296	0.280	0.283	0.307	0.313	0.296
	y	0.229	0.267	0.248	0.220	0.267	0.305	0.276	0.248	0.305	0.337	0.297	0.276

Rank	B2				c				
Chromaticity Coordinates	x	0.307	0.330	0.330	0.313	0.330	0.361	0.356	0.330
	y	0.337	0.360	0.318	0.297	0.360	0.385	0.351	0.318

Forward Voltage (V_F)

Rank	V7	V8	V9	V10	V11	V12	V13	V14
Voltage	2.8-3.0 V	3.0-3.2 V	3.2-3.4 V	3.4-3.6 V	3.6-3.8 V	3.8-4.0 V	4.0-4.2 V	4.2-4.4 V

Important Notes:

- All ranks will be included per delivery; rank ratio will be based on the dice distribution.
- Pb content <1000 ppm.
- Tolerance of measurement of luminous intensity is $\pm 15\%$.
- Tolerance of measurement of the chromaticity coordinates is ± 0.01 .
- Tolerance of measurement of V_F is $\pm 0.05 \text{ V}$.
- Packaging methods are available for selection; please refer to the "Cree LED Lamp Packaging Standard" document.
- Please refer to the "Cree LED Lamp Reliability Test Standards" document for reliability test conditions.
- Please refer to the "Cree LED Lamp Soldering & Handling" document for information about how to use this LED product safely.

CIE Chromaticity Diagram

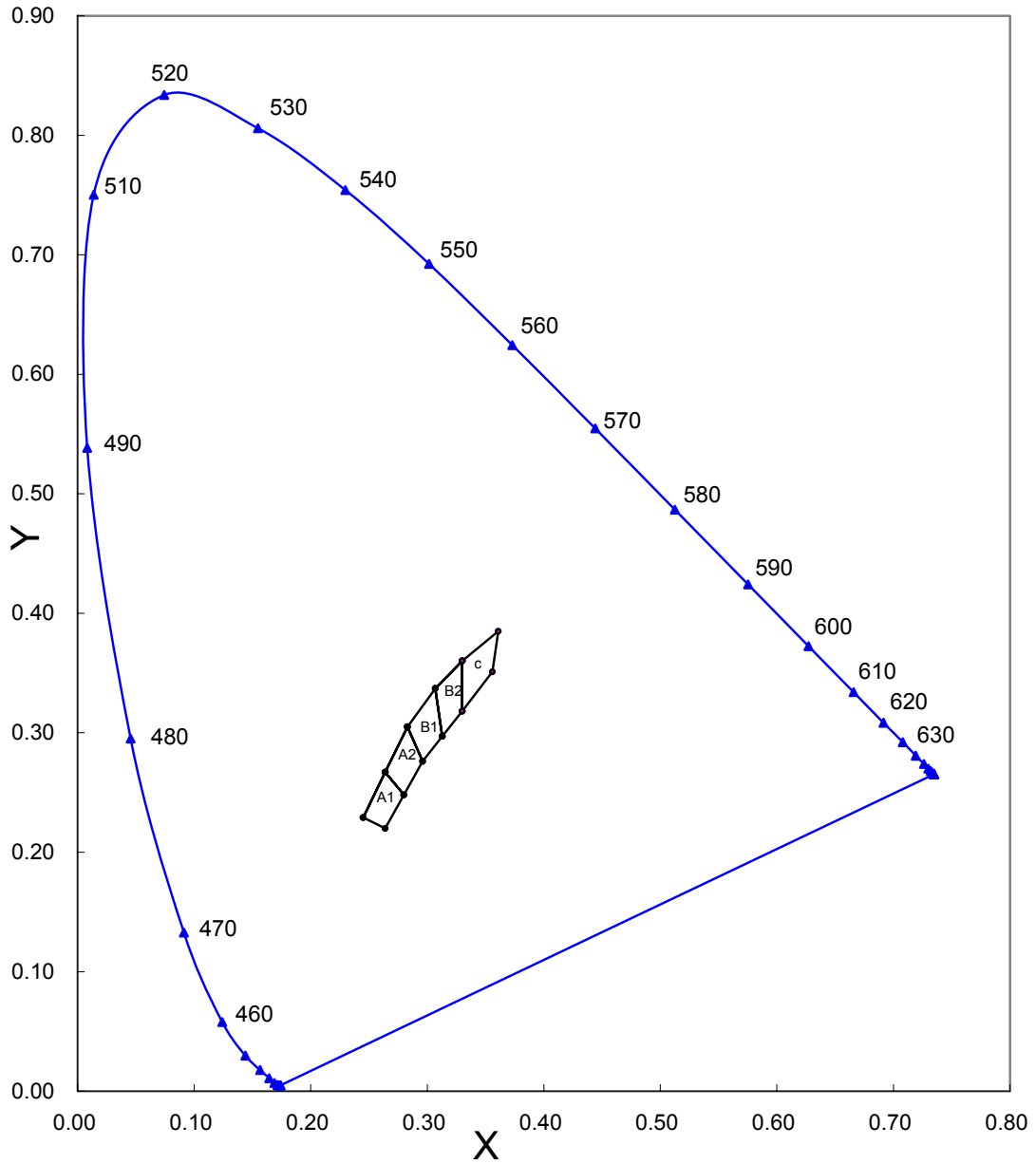

Graphs

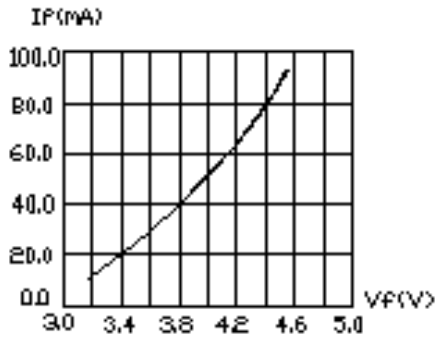

FIG.1 FORWARD CURRENT VS. FORWARD VOLTAGE

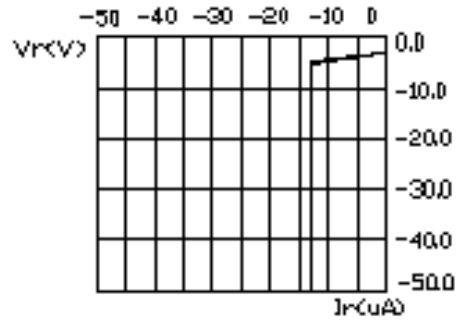

FIG.2 REVERSE CURRENT VS. REVERSE VOLTAGE

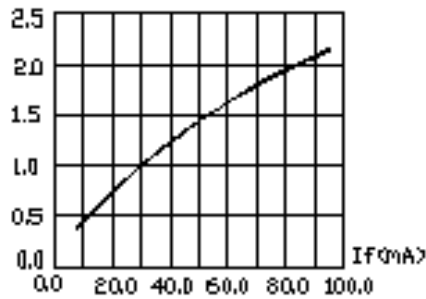

FIG.3 RELATIVE LUMINOUS INTENSITY VS. FORWARD CURRENT

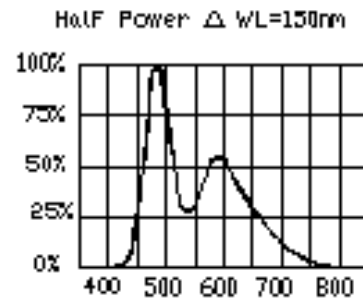

FIG.4 RELATIVE LUMINOUS INTENSITY VS. WAVELENGTH

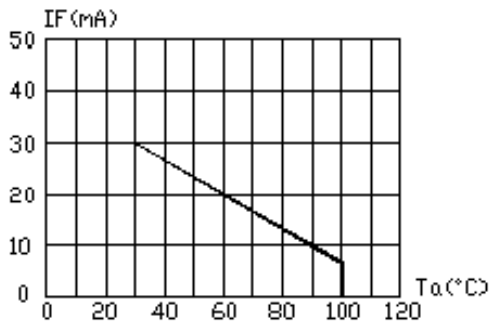

FIG.5 MAXIMUM FORWARD CURRENT VS. AMBIENT TEMPERATURE (Tjmax=120°C)

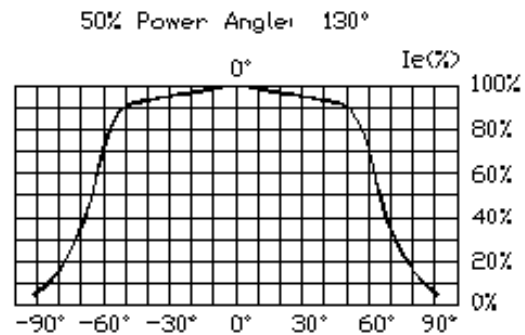

FIG.6 FAR FIELD PATTERN

Mechanical Dimensions

All dimensions are in mm. Tolerance is ± 0.25 mm unless otherwise noted.

An epoxy meniscus may extend about 1.5 mm down the leads.

Burr around bottom of epoxy may be 0.5 mm max.

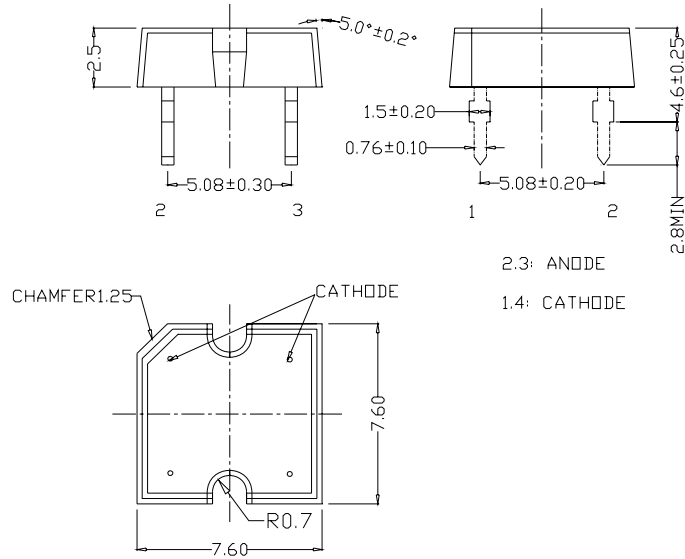

Notes

RoHS Compliance

The levels of environmentally sensitive, persistent biologically toxic (PBT), persistent organic pollutants (POP), or otherwise restricted materials in this product are below the maximum concentration values (also referred to as the threshold limits) permitted for such substances, or are used in an exempted application, in accordance with EU Directive 2002/95/EC on the restriction of the use of certain hazardous substances in electrical and electronic equipment (RoHS), as amended through April 21, 2006.

Vision Advisory Claim

Users should be cautioned not to stare at the light of this LED product. The bright light can damage the eye.

Kit Number System

Cree LED lamps are tested and sorted into performance bins. A bin is specified by ranges of color, forward voltage, and brightness. Sorted LEDs are packaged for shipping in various convenient options. Please refer to the "Cree LED Lamp Packaging Standard" document for more information about shipping and packaging options.

Cree LEDs are sold by order codes in combinations of bins called kits. Order codes are configured in the following manner:

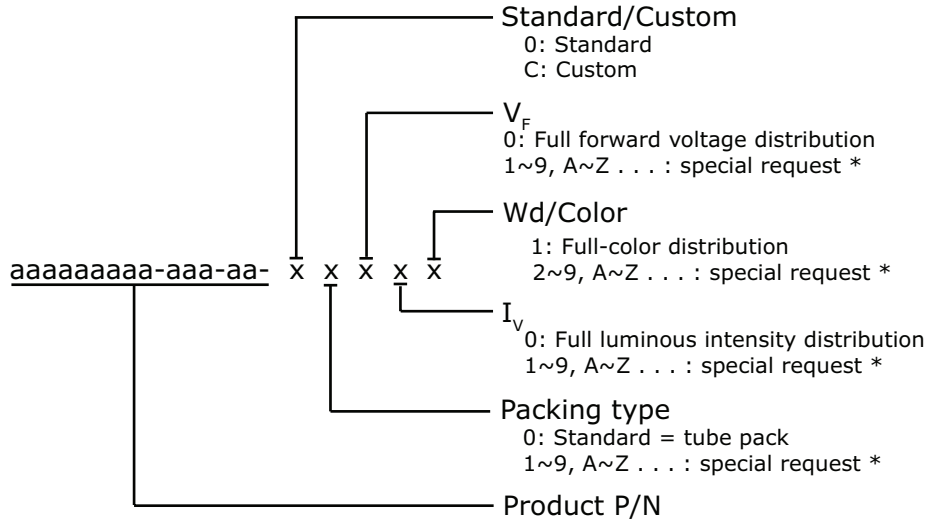

* Contact your Cree sales representative for ordering information.

Standard Available Kits*

Kit Number	Description
LP368PWN-D0G-00001	P4 130 White, FULL RANK, Tube Pack
LP368PWN-D0G-00002	P4 130 White, A1, A2, B1, B2, Tube Pack

* Please contact your Cree representative about the availability of non-standard kits.