

TOSHIBA BIPOLAR LINEAR INTEGRATED CIRCUIT SILICON MONOLITHIC

# TA75S393F

## SINGLE VOLTAGE COMPARATOR

This device of voltage comparator that designed to operate from a single power supply over a wide range of voltage.

Normal operation from dual supplies is also to be guaranteed on voltage range from  $\pm 1V$  to  $\pm 18V$ .

$V_{CC}$  is necessary at least more 1.5V volts than the input common mode voltage.

The output can be connected to other open collector outputs to achieve Wired-OR relation ship.

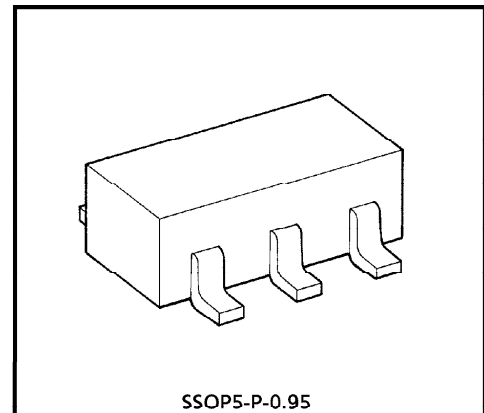

SSOP5-P-0.95

Weight : 0.014g (Typ.)

### FEATURES

- Compatible to TA75393.
- Small Package
- Single supply voltage range or dual supplies :  $2V_{DC}$  to  $36V_{DC}$  or  $\pm 1V_{DC}$  to  $\pm 18V_{DC}$
- Low supply current : 0.4mA (Typ.)
- Low input offset voltage :  $\pm 2mV$  (Typ.)
- Wide input common mode voltage range :  $0V_{DC}$  to  $V_{CC} - 1.5V_{DC}$
- Output compatible with TTL, DTL, MOS and CMOS logic system.
- The output can be connected to achieve Wired-OR relation.

### MARKING (TOP VIEW)

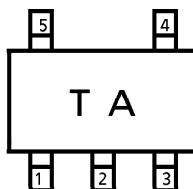

### PIN CONNECTION (TOP VIEW)

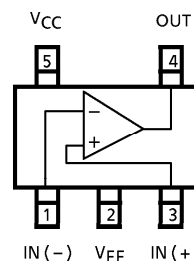

961001EBA2

● TOSHIBA is continually working to improve the quality and the reliability of its products. Nevertheless, semiconductor devices in general can malfunction or fail due to their inherent electrical sensitivity and vulnerability to physical stress. It is the responsibility of the buyer, when utilizing TOSHIBA products, to observe standards of safety, and to avoid situations in which a malfunction or failure of a TOSHIBA product could cause loss of human life, bodily injury or damage to property. In developing your designs, please ensure that TOSHIBA products are used within specified operating ranges as set forth in the most recent products specifications. Also, please keep in mind the precautions and conditions set forth in the TOSHIBA Semiconductor Reliability Handbook.

● The products described in this document are subject to foreign exchange and foreign trade control laws.

● The information contained herein is presented only as a guide for the applications of our products. No responsibility is assumed by TOSHIBA CORPORATION for any infringements of intellectual property or other rights of the third parties which may result from its use. No license is granted by implication or otherwise under any intellectual property or other rights of TOSHIBA CORPORATION or others.

● The information contained herein is subject to change without notice.

EQUIVALENT CIRCUIT

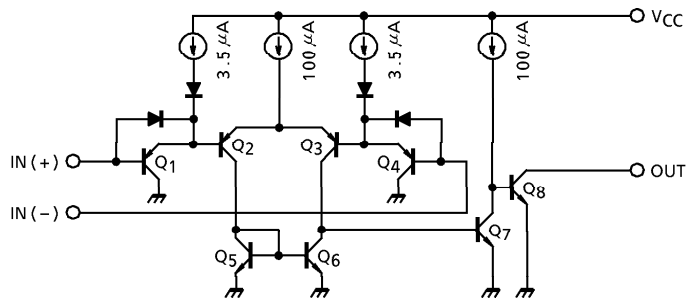

MAXIMUM RATINGS (Ta = 25°C)

CHARACTERISTIC	SYMBOL	RATING	UNIT
Supply Voltage	$V_{CC}, V_{EE}$	$\pm 18$ or 36	V
Differential Input Voltage	$DV_{IN}$	$\pm 36$	V
Input Voltage	$V_{IN}$	$-0.3 \sim V_{CC}$	V
Power Dissipation	$P_D$	200	mW
Operating Temperature	$T_{opr}$	$-40 \sim 85$	°C
Storage Temperature	$T_{stg}$	$-55 \sim 125$	°C

ELECTRICAL CHARACTERISTICS ( $V_{CC} = 5V, V_{EE} = GND, T_a = 25^\circ C$ )

CHARACTERISTIC	SYMBOL	TEST CIRCUIT	TEST CONDITION	MIN.	TYP.	MAX.	UNIT
Input Offset Voltage	$V_{IO}$	1	—	—	2	5	mV
Input Bias Current	$I_{IO}$	2	—	—	5	50	nA
Input Offset Current	$I_I$	2	—	—	25	250	nA
Common Mode Input Voltage	$CMV_{IN}$	—	—	0	—	$V_{CC} - 1.5$	V
Supply Current	$I_{CC}$	3	No load	—	0.4	0.8	mA
Voltage Gain	$G_V$	—	$R_L = 15k\Omega$	—	200	—	V/mA
Sink Current	$I_{sink}$	4	$IN(+) = 0V, IN(-) = 1V$ $V_{OL} = 1.5V$	6	16	—	mA
Output Voltage ("L" Level)	$V_{OL}$	5	$IN(+) = 0V, IN(-) = 1V$ $I_{sink} = 3mA$	—	0.2	0.4	V
Output Leak Current	$I_{LEAK}$	—	$IN(+) = 1V, IN(-) = 0V$ $V_O = 5V$	—	0.1	—	nA
Response Time	$t_{rsp}$	6	$R_L = 5.1k\Omega, C_L = 15pF$	—	1.3	—	$\mu s$

TEST CIRCUIT

(1)  $V_{IO}$

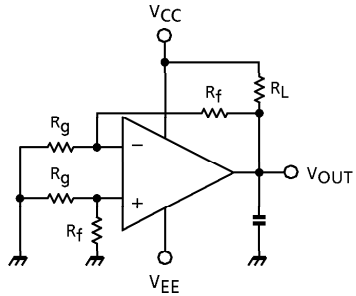

(2)  $I_I, I_{IO}$

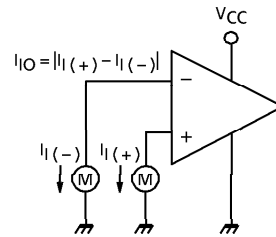

(3)  $I_{CC}$

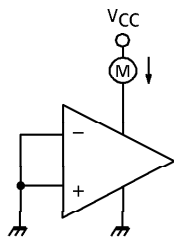

(4)  $I_{sink}$

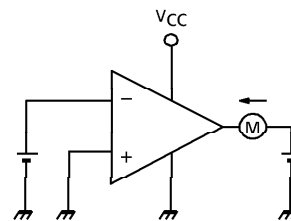

(5)  $V_{OL}$

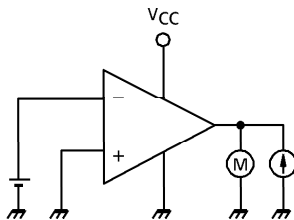

(6)  $t_{rsp}$

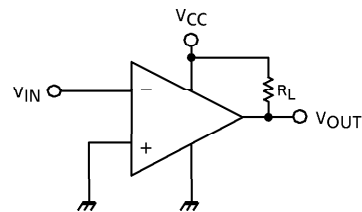

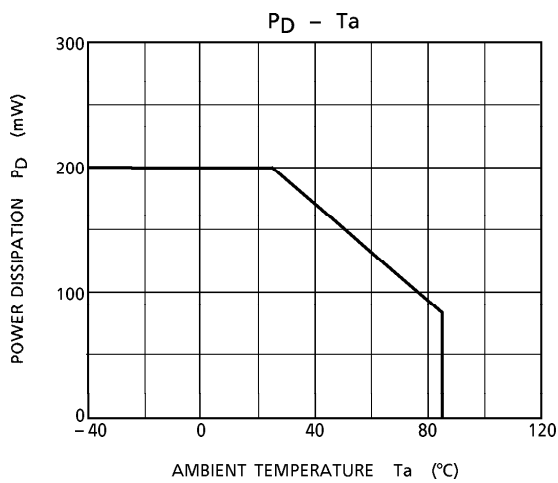
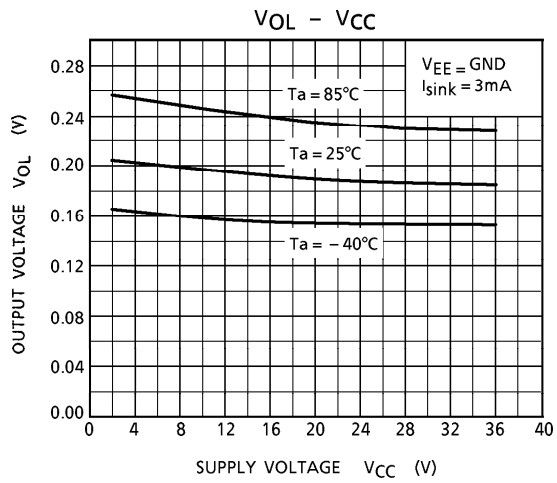
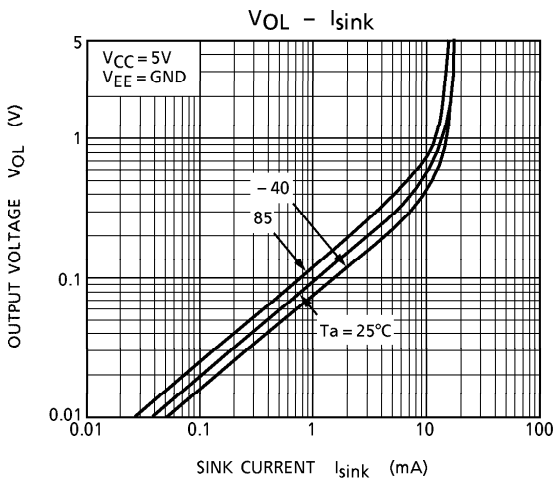
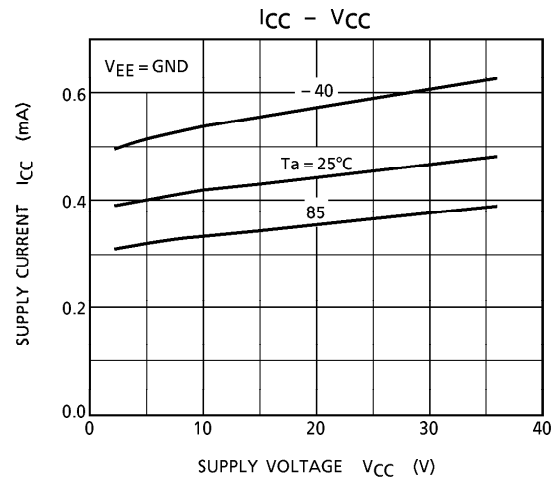
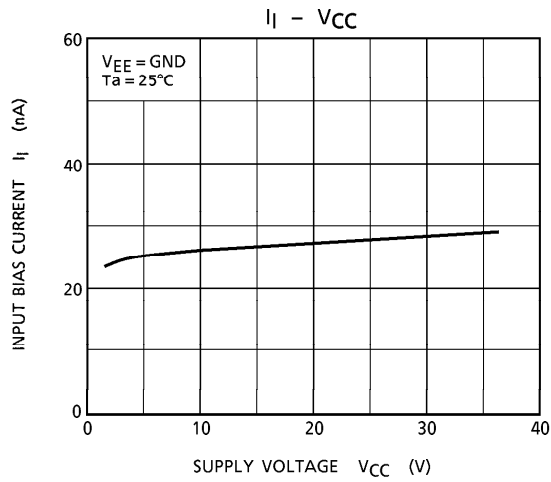

OUTLINE DRAWING  
SSOP5-P-0.95

Unit : mm

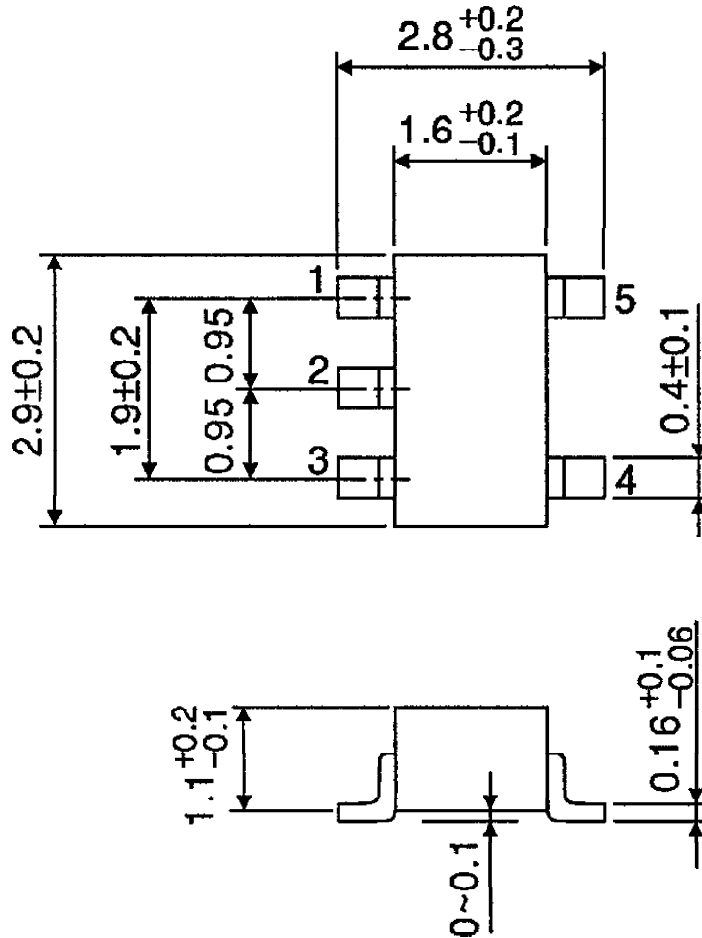

Weight : 0.014g (Typ.)