

LMC7101

Tiny Low Power Operational Amplifier with Rail-To-Rail Input and Output

General Description

The LMC7101 is a high performance CMOS operational amplifier available in the space saving SOT 23-5 Tiny package. This makes the LMC7101 ideal for space and weight critical designs. The performance is similar to a single amplifier of the LMC6482/6484 type, with rail-to-rail input and output, high open loop gain, low distortion, and low supply currents.

The main benefits of the Tiny package are most apparent in small portable electronic devices, such as mobile phones, pagers, notebook computers, personal digital assistants, and PCMCIA cards. The tiny amplifiers can be placed on a board where they are needed, simplifying board layout.

Features

- Tiny SOT23-5 package saves space—typical circuit layouts take half the space of SO-8 designs
- Guaranteed specs at 2.7V, 3V, 5V, 15V supplies
- Typical supply current 0.5 mA at 5V
- Typical total harmonic distortion of 0.01% at 5V
- 1.0 MHz gain-bandwidth
- Similar to popular LMC6482/6484
- Rail-to-rail input and output

Applications

- Mobile communications
- Notebooks and PDAs
- Battery powered products
- Sensor interface

Connection Diagram

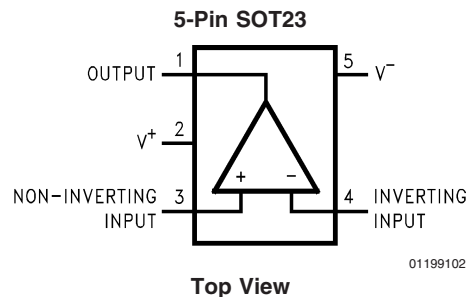

Ordering Information

Package	Part Number	Package Marking	Transport Media	NSC Drawing
5-Pin SOT23	LMC7101AIM5	A00A	1k Units on Tape and Reel	MF05A
	LMC7101AIM5X	A00A	3k Units Tape and Reel	
	LMC7101BIM5	A00B	1k Units on Tape and Reel	
	LMC7101BIM5X	A00B	3k Units Tape and Reel	

Absolute Maximum Ratings (Note 1)

If Military/Aerospace specified devices are required, please contact the National Semiconductor Sales Office/Distributors for availability and specifications.

ESD Tolerance (Note 2)	2000V
Difference Input Voltage	±Supply Voltage
Voltage at Input/Output Pin	(V ⁺) + 0.3V, (V ⁻) – 0.3V
Supply Voltage (V ⁺ – V ⁻)	16V
Current at Input Pin	±5 mA
Current at Output Pin (Note 3)	±35 mA
Current at Power Supply Pin	35 mA
Lead Temp. (Soldering, 10 sec.)	260°C

Storage Temperature Range	–65°C to +150°C
Junction Temperature (Note 4)	150°C

Recommended Operating Conditions (Note 1)

Supply Voltage	2.7V ≤ V ⁺ ≤ 15.5V
Temperature Range	
LMC7101AI, LMC7101BI	–40°C to +85°C
Thermal Resistance (θ _{JA})	
5-Pin STO23	325°C/W

2.7V Electrical Characteristics

Unless otherwise specified, all limits guaranteed for T_J = 25°C, V⁺ = 2.7V, V⁻ = 0V, V_{CM} = V_O = V⁺/2 and R_L > 1 MΩ. **Bold-face** limits apply at the temperature extremes.

Symbol	Parameter	Conditions	Typ (Note 5)	LMC7101AI Limit (Note 6)	LMC7101BI Limit (Note 6)	Units
V _{OS}	Input Offset Voltage	V ⁺ = 2.7V	0.11	6	9	mV max
TCV _{OS}	Input Offset Voltage Average Drift		1			μV/°C
I _B	Input Bias Current		1.0	64	64	pA max
I _{OS}	Input Offset Current		0.5	32	32	pA max
R _{IN}	Input Resistance		>1			Tera Ω
CMRR	Common-Mode Rejection Ratio	0V ≤ V _{CM} ≤ 2.7V V ⁺ = 2.7V	70	55	50	dB min
V _{CM}	Input Common-Mode Voltage Range	For CMRR ≥ 50 dB	0.0 3.0	0.0 2.7	0.0 2.7	V min V max
PSRR	Power Supply Rejection Ratio	V ⁺ = 1.35V to 1.65V V ⁻ = –1.35V to –1.65V V _{CM} = 0	60	50	45	dB min
C _{IN}	Common-Mode Input Capacitance		3			pF
V _O	Output Swing	R _L = 2 kΩ	2.45 0.25	2.15 0.5	2.15 0.5	V min V max
		R _L = 10 kΩ	2.68 0.025	2.64 0.06	2.64 0.06	V min V max
I _S	Supply Current		0.5	0.81 0.95	0.81 0.95	mA max
SR	Slew Rate (Note 8)		0.7			V/μs
GBW	Gain-Bandwidth Product		0.6			MHz

3V DC Electrical Characteristics

Unless otherwise specified, all limits guaranteed for $T_J = 25^\circ\text{C}$, $V^+ = 3\text{V}$, $V^- = 0\text{V}$, $V_{\text{CM}} = 1.5\text{V}$, $V_O = V^+/2$ and $R_L = 1\text{ M}\Omega$.

Boldface limits apply at the temperature extremes.

Symbol	Parameter	Conditions	Typ (Note 5)	LMC7101AI Limit (Note 6)	LMC7101BI Limit (Note 6)	Units
V_{OS}	Input Offset Voltage		0.11	4 6	7 9	mV max
TCV_{OS}	Input Offset Voltage Average Drift		1			$\mu\text{V}/^\circ\text{C}$
I_{B}	Input Current		1.0	64	64	μA max
I_{OS}	Input Offset Current		0.5	32	32	μA max
R_{IN}	Input Resistance		>1			Tera Ω
CMRR	Common-Mode Rejection Ratio	$0\text{V} \leq V_{\text{CM}} \leq 3\text{V}$ $V^+ = 3\text{V}$	74	64	60	db min
V_{CM}	Input Common-Mode Voltage Range	For CMRR ≥ 50 dB	0.0	0.0	0.0	V min
			3.3	3.0	3.0	V max
PSRR	Power Supply Rejection Ratio	$V^+ = 1.5\text{V to } 7.5\text{V}$ $V^- = -1.5\text{V to } -7.5\text{V}$ $V_O = V_{\text{CM}} = 0$	80	68	60	dB min
C_{IN}	Common-Mode Input Capacitance		3			pF
V_O	Output Swing	$R_L = 2\text{ k}\Omega$	2.8	2.6	2.6	V min
			0.2	0.4	0.4	V max
		$R_L = 600\Omega$	2.7	2.5	2.5	V min
			0.37	0.6	0.6	V max
I_{S}	Supply Current		0.5	0.81 0.95	0.81 0.95	mA max

5V DC Electrical Characteristics

Unless otherwise specified, all limits guaranteed for $T_J = 25^\circ\text{C}$, $V^+ = 5\text{V}$, $V^- = 0\text{V}$, $V_{\text{CM}} = 1.5\text{V}$, $V_O = V^+/2$ and $R_L = 1\text{ M}\Omega$.
Boldface limits apply at the temperature extremes.

Symbol	Parameter	Conditions	Typ (Note 5)	LMC7101AI Limit (Note 6)	LMC7101BI Limit (Note 6)	Units	
V_{OS}	Input Offset Voltage	$V^+ = 5\text{V}$	0.11	3 5	7 9	mV max	
TCV_{OS}	Input Offset Voltage Average Drift		1.0			$\mu\text{V}/^\circ\text{C}$	
I_{B}	Input Current		1	64	64	pA max	
I_{OS}	Input Offset Current		0.5	32	32	pA max	
R_{IN}	Input Resistance		>1			Tera Ω	
CMRR	Common-Mode Rejection Ratio	$0\text{V} \leq V_{\text{CM}} \leq 5\text{V}$	82	65 60	60 55	db min	
+PSRR	Positive Power Supply Rejection Ratio	$V^+ = 5\text{V}$ to 15V $V^- = 0\text{V}$, $V_O = 1.5\text{V}$	82	70 65	65 62	dB min	
-PSRR	Negative Power Supply Rejection Ratio	$V^- = -5\text{V}$ to -15V $V^+ = 0\text{V}$, $V_O = -1.5\text{V}$	82	70 65	65 62	dB min	
V_{CM}	Input Common-Mode Voltage Range	For CMRR $\geq 50\text{ dB}$	-0.3	-0.20 0.00	-0.20 0.00	V min	
			5.3	5.20 5.00	5.20 5.00	V max	
C_{IN}	Common-Mode Input Capacitance		3			pF	
V_O	Output Swing	$R_L = 2\text{ k}\Omega$	4.9	4.7 4.6	4.7 4.6	V min	
			0.1	0.18 0.24	0.18 0.24	V max	
		$R_L = 600\Omega$	4.7	4.5 4.24	4.5 4.24	V min	
			0.3	0.5 0.65	0.5 0.65	V max	
I_{SC}	Output Short Circuit Current	$V_O = 0\text{V}$	Sourcing	24	16 11	16 11	mA min
		$V_O = 5\text{V}$	Sinking	19	11 7.5	11 7.5	mA min
I_{S}	Supply Current		0.5	0.85 1.0	0.85 1.0	mA max	

5V AC Electrical Characteristics

Unless otherwise specified, all limits guaranteed for $T_J = 25^\circ\text{C}$, $V^+ = 5\text{V}$, $V^- = 0\text{V}$, $V_{\text{CM}} = 1.5\text{V}$, $V_O = V^+/2$ and $R_L = 1\text{ M}\Omega$.
Boldface limits apply at the temperature extremes.

Symbol	Parameter	Conditions	Typ (Note 5)	LMC7101AI Limit (Note 6)	LMC7101BI Limit (Note 6)	Units
THD	Total Harmonic Distortion	$F = 10\text{ kHz}$, $A_V = -2$ $R_L = 10\text{ k}\Omega$, $V_O = 4.0\text{ V}_{\text{PP}}$	0.01			%
SR	Slew Rate		1.0			$\text{V}/\mu\text{s}$
GBW	Gain Bandwidth Product		1.0			MHz

15V DC Electrical Characteristics

Unless otherwise specified, all limits guaranteed for $T_J = 25^\circ\text{C}$, $V^+ = 15\text{V}$, $V^- = 0\text{V}$, $V_{\text{CM}} = 1.5\text{V}$, $V_O = V^+/2$ and $R_L = 1\text{ M}\Omega$.
Boldface limits apply at the temperature extremes.

Symbol	Parameter	Conditions		Typ (Note 5)	LMC7101AI Limit (Note 6)	LMC7101BI Limit (Note 6)	Units
V_{OS}	Input Offset Voltage			0.11			mV max
TCV_{OS}	Input Offset Voltage Average Drift			1.0			$\mu\text{V}/^\circ\text{C}$
I_{B}	Input Current			1.0	64	64	pA max
I_{OS}	Input Offset Current			0.5	32	32	pA max
R_{IN}	Input Resistance			>1			Tera Ω
CMRR	Common-Mode Rejection Ratio	$0\text{V} \leq V_{\text{CM}} \leq 15\text{V}$		82	70 65	65 60	dB min
+PSRR	Positive Power Supply Rejection Ratio	$V^+ = 5\text{V to } 15\text{V}$ $V^- = 0\text{V}, V_O = 1.5\text{V}$		82	70 65	65 62	dB min
-PSRR	Negative Power Supply Rejection Ratio	$V^- = -5\text{V to } -15\text{V}$ $V^+ = 0\text{V}, V_O = -1.5\text{V}$		82	70 65	65 62	dB min
V_{CM}	Input Common-Mode Voltage Range	$V^+ = 5\text{V}$ For CMRR $\geq 50\text{ dB}$		-0.3	-0.20 0.00	-0.20 0.00	V min
				15.3	15.20 15.00	15.20 15.00	V max
A_{V}	Large Signal Voltage Gain (Note 7)	$R_L = 2\text{ k}\Omega$	Sourcing	340	80 40	80 40	V/mV
			Sinking	24	15 10	15 10	
		$R_L = 600\Omega$	Sourcing	300	34	34	
			Sinking	15	6	6	
C_{IN}	Input Capacitance			3			pF
V_{O}	Output Swing	$V^+ = 15\text{V}$ $R_L = 2\text{ k}\Omega$		14.7	14.4 14.2	14.4 14.2	V min
				0.16	0.32 0.45	0.32 0.45	V max
		$V^+ = 15\text{V}$ $R_L = 600\Omega$		14.1	13.4 13.0	13.4 13.0	V min
				0.5	1.0 1.3	1.0 1.3	V max
I_{SC}	Output Short Circuit Current (Note 9)	$V_{\text{O}} = 0\text{V}$	Sourcing	50	30 20	30 20	mA min
		$V_{\text{O}} = 12\text{V}$	Sinking	50	30 20	30 20	
I_{S}	Supply Current			0.8	1.50 1.71	1.50 1.71	mA max

15V AC Electrical Characteristics

Unless otherwise specified, all limits guaranteed for $T_J = 25^\circ\text{C}$, $V^+ = 15\text{V}$, $V^- = 0\text{V}$, $V_{\text{CM}} = 1.5\text{V}$, $V_O = V^+/2$ and $R_L = 1\text{M}\Omega$. **Boldface** limits apply at the temperature extremes.

Symbol	Parameter	Conditions	Typ (Note 5)	LMC7101AI Limit (Note 6)	LMC7101BI Limit (Note 6)	Units
SR	Slew Rate (Note 8)	$V^+ = 15\text{V}$	1.1	0.5 0.4	0.5 0.4	V/ μs min
GBW	Gain-Bandwidth Product	$V^+ = 15\text{V}$	1.1			MHz
ϕ_m	Phase Margin		45			deg
G_m	Gain Margin		10			dB
e_n	Input-Referred Voltage Noise	$f = 1\text{ kHz}$, $V_{\text{CM}} = 1\text{V}$	37			$\frac{\text{nV}}{\sqrt{\text{Hz}}}$
i_n	Input-Referred Current Noise	$f = 1\text{ kHz}$	1.5			$\frac{\text{fA}}{\sqrt{\text{Hz}}}$
THD	Total Harmonic Distortion	$f = 10\text{ kHz}$, $A_V = -2$ $R_L = 10\text{ k}\Omega$, $V_O = 8.5\text{ V}_{\text{PP}}$	0.01			%

Note 1: Absolute Maximum Ratings indicate limits beyond which damage to the device may occur. Operating Ratings indicate conditions for which the device is intended to be functional, but specific performance is not guaranteed. For guaranteed specifications and the test conditions, see the Electrical Characteristics.

Note 2: Human Body Model is 1.5 k Ω in series with 100 pF.

Note 3: Applies to both single-supply and split-supply operation. Continuous short operation at elevated ambient temperature can result in exceeding the maximum allowed junction temperature at 150°C.

Note 4: The maximum power dissipation is a function of $T_{\text{J(MAX)}}$, θ_{JA} and T_{A} . The maximum allowable power dissipation at any ambient temperature is $P_D = (T_{\text{J(MAX)}} - T_{\text{A}})/\theta_{\text{JA}}$. All numbers apply for packages soldered directly into a PC board.

Note 5: Typical Values represent the most likely parametric norm.

Note 6: All limits are guaranteed by testing or statistical analysis.

Note 7: $V^+ = 15\text{V}$, $V_{\text{CM}} = 1.5\text{V}$ and R_L connect to 7.5V. For sourcing tests, $7.5\text{V} \leq V_O \leq 12.5\text{V}$. For sinking tests, $2.5\text{V} \leq V_O \leq 7.5\text{V}$.

Note 8: $V^+ = 15\text{V}$. Connected as a voltage follower with a 10V step input. Number specified is the slower of the positive and negative slew rates. $R_L = 100\text{ k}\Omega$ connected to 7.5V. Amp excited with 1 kHz to produce $V_O = 10\text{ V}_{\text{PP}}$.

Note 9: Do not short circuit output to V^+ when V^+ is greater than 12V or reliability will be adversely affected.

2.7V Typical Performance Characteristics $V^+ = 2.7\text{V}$, $V^- = 0\text{V}$, $T_{\text{A}} = 25^\circ\text{C}$, unless otherwise specified.

Open Loop Frequency Response

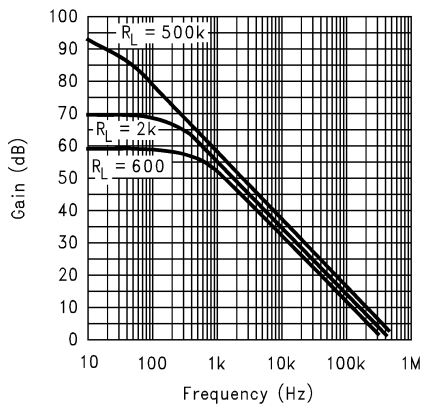

01199116

Input Voltage vs. Output Voltage

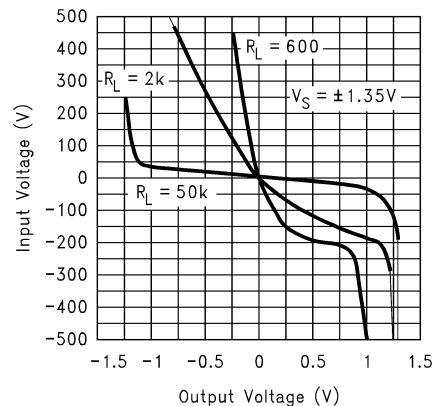

01199117

2.7V Typical Performance Characteristics $V^+ = 2.7V$, $V^- = 0V$, $T_A = 25^\circ C$, unless otherwise specified. (Continued)

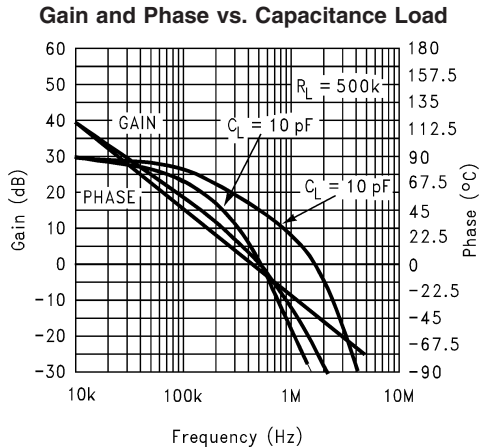

01199118

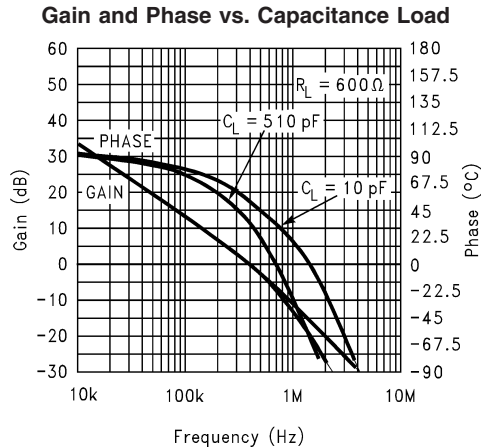

01199119

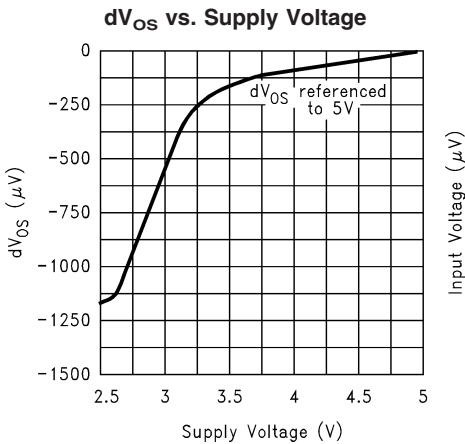

01199120

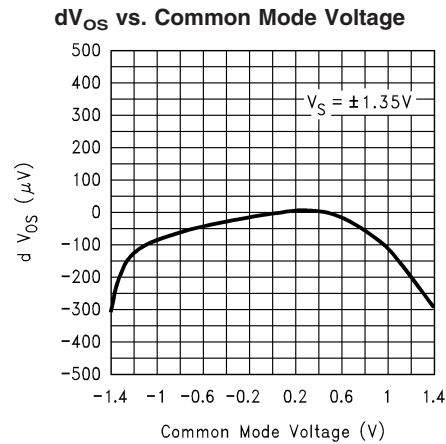

01199121

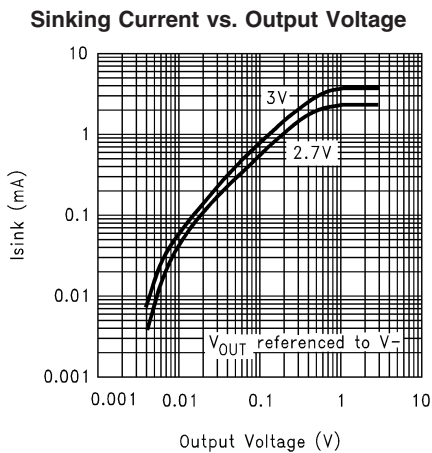

01199122

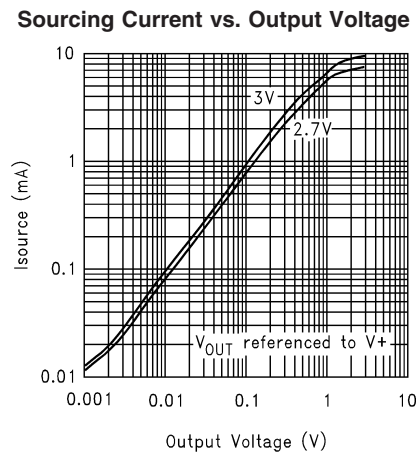

01199123

3V Typical Performance Characteristics $V^+ = 3V, V^- = 0V, T_A = 25^\circ C$, unless otherwise specified.

Open Loop Frequency Response

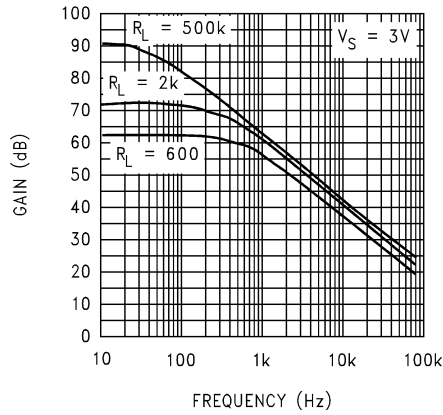

Input Voltage vs. Output Voltage

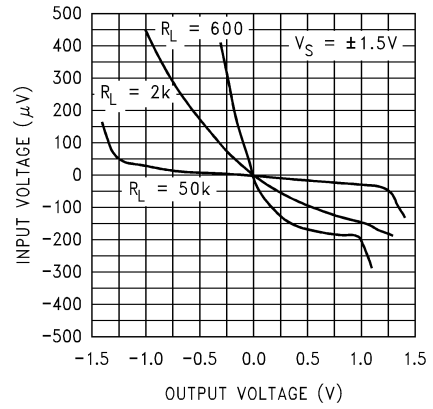

Input Voltage Noise vs. Input Voltage

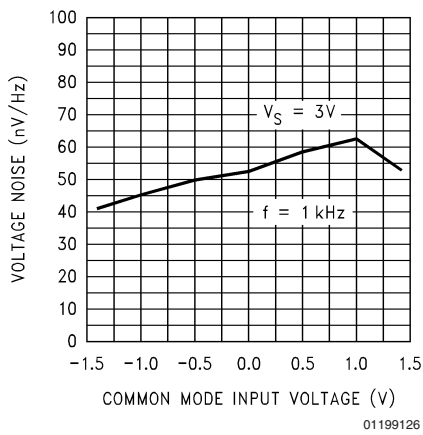

Sourcing Current vs. Output Voltage

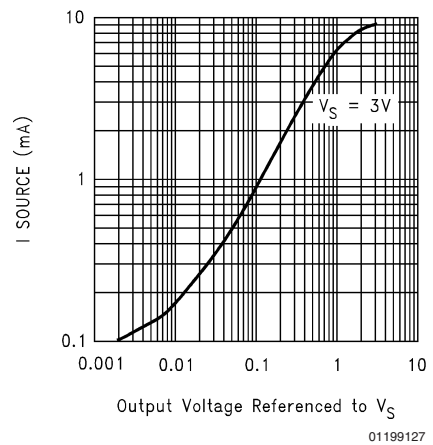

Sinking Current vs. Output Voltage

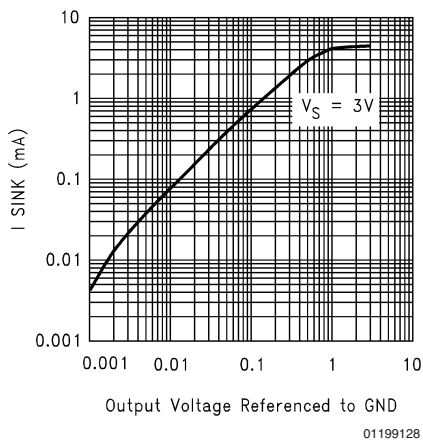

CMRR vs. Input Voltage

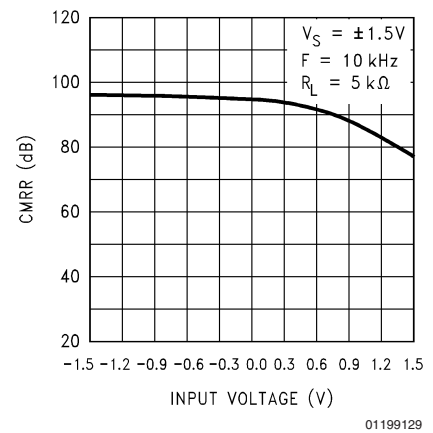

5V Typical Performance Characteristics $V^+ = 5V, V^- = 0V, T_A = 25^\circ C$, unless otherwise specified.

Open Loop Frequency Response

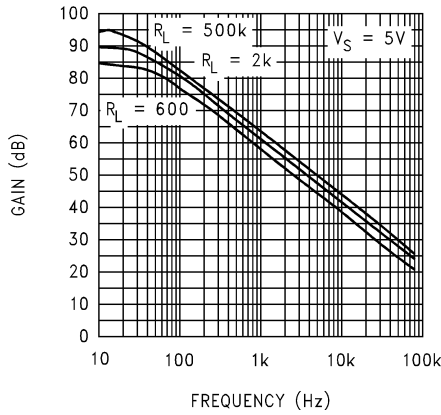

01199130

Input Voltage vs. Output Voltage

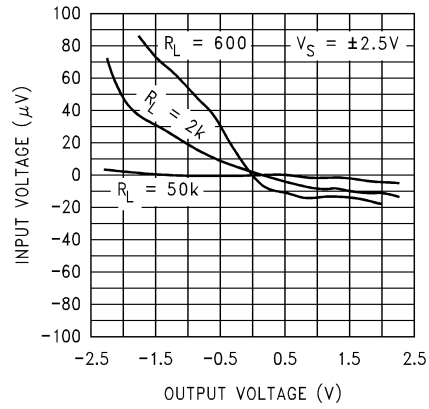

01199131

Input Voltage Noise vs. Input Voltage

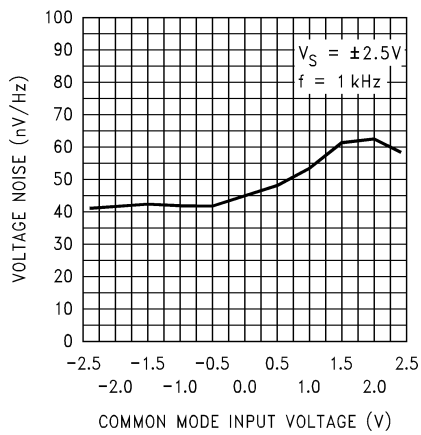

01199132

Sourcing Current vs. Output Voltage

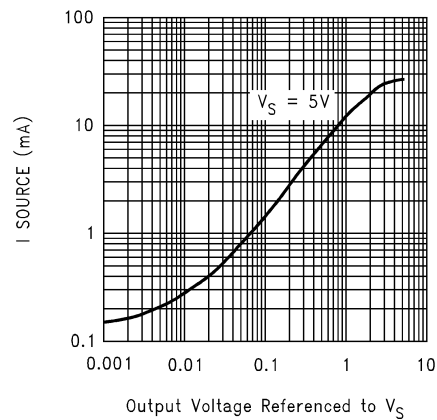

01199133

Sinking Current vs. Output Voltage

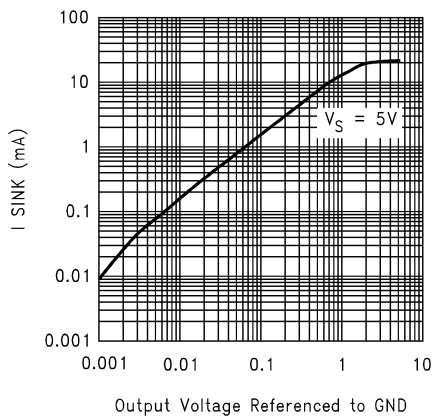

01199134

CMRR vs. Input Voltage

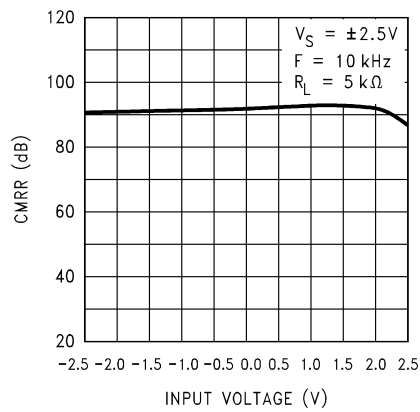

01199135

15V Typical Performance Characteristics $V^+ = +15V, V^- = 0V, T_A = 25^\circ C$, unless otherwise specified.

Open Loop Frequency Response

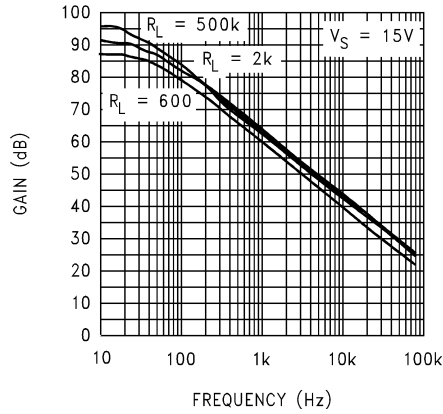

01199136

Input Voltage vs. Output Voltage

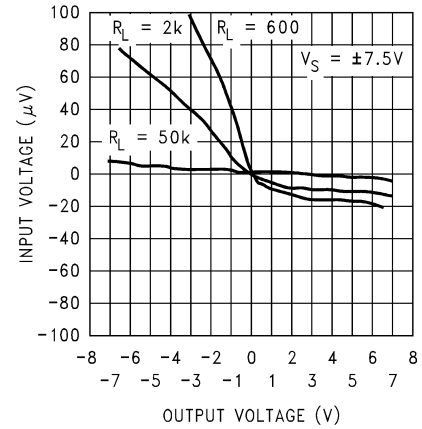

01199137

Input Voltage Noise vs. Input Voltage

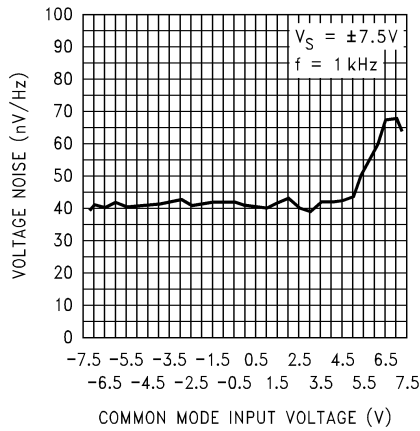

01199138

Sourcing Current vs. Output Voltage

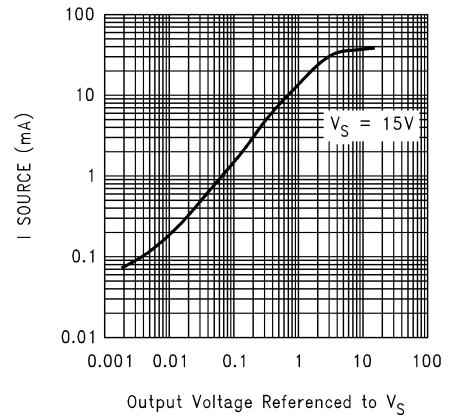

01199139

Sinking Current vs. Output Voltage

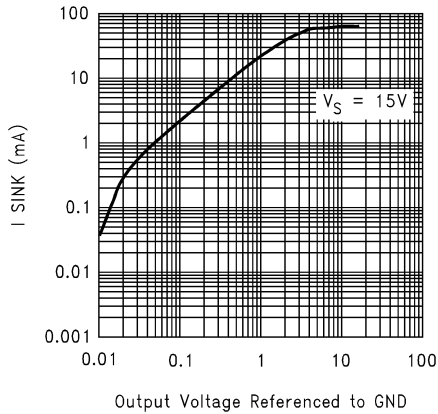

01199140

CMRR vs. Input Voltage

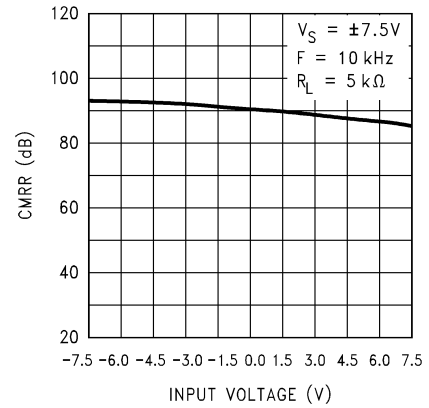

01199141

15V Typical Performance Characteristics $V^+ = +15V$, $V^- = 0V$, $T_A = 25^\circ C$, unless otherwise specified. (Continued)

Supply Current vs. Supply Voltage

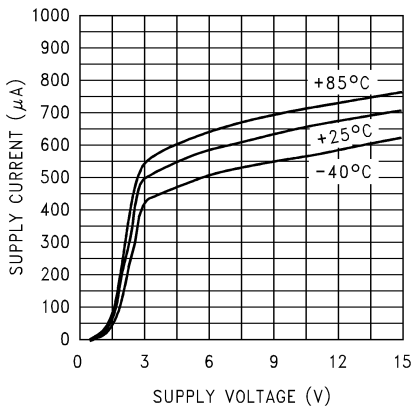

01199142

Input Current vs. Temperature

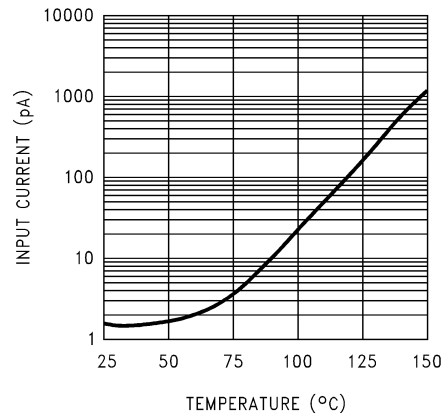

01199143

Output Voltage Swing vs. Supply Voltage

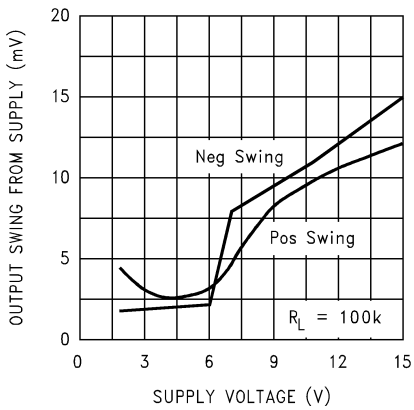

01199144

Input Voltage Noise vs. Frequency

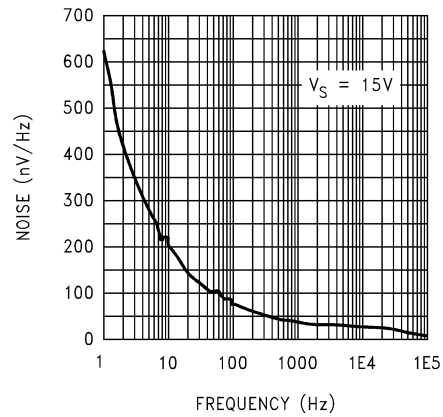

01199145

Positive PSRR vs. Frequency

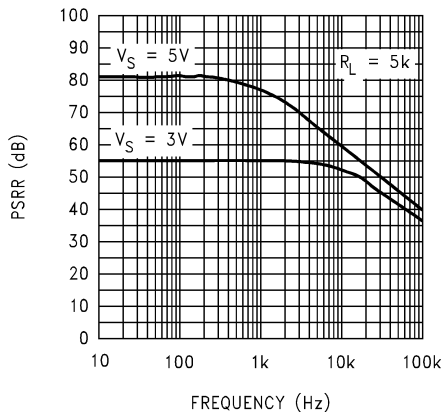

01199146

Negative PSRR vs. Frequency

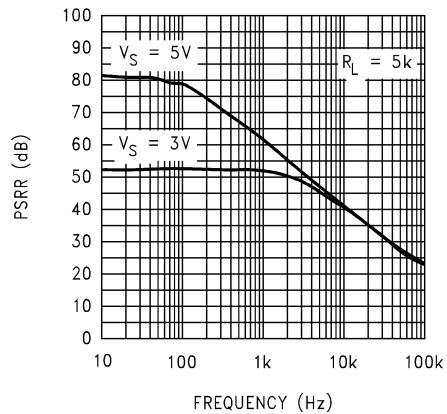

01199147

15V Typical Performance Characteristics $V^+ = +15V, V^- = 0V, T_A = 25^\circ C$, unless otherwise specified. (Continued)

CMRR vs. Frequency

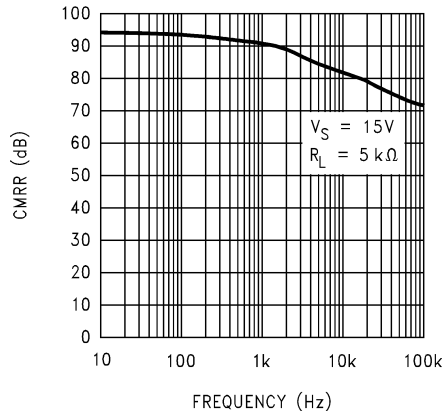

Open Loop Frequency Response @ $-40^\circ C$

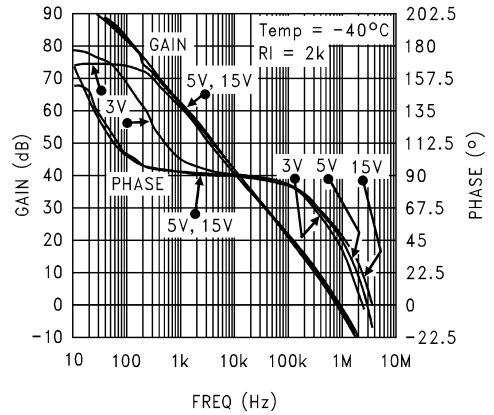

Open Loop Frequency Response @ $25^\circ C$

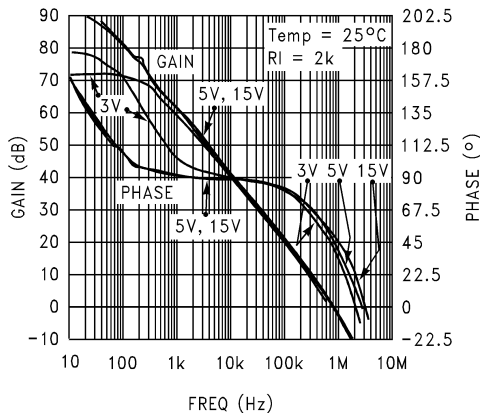

Open Loop Frequency Response @ $85^\circ C$

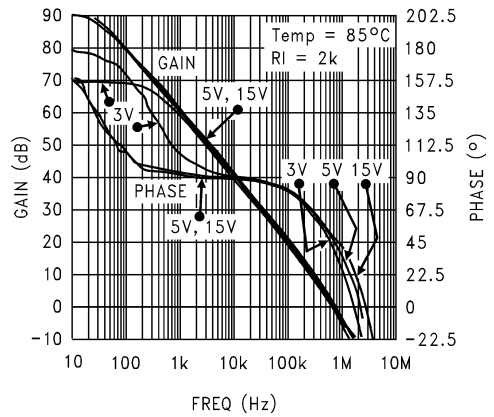

Maximum Output Swing vs. Frequency

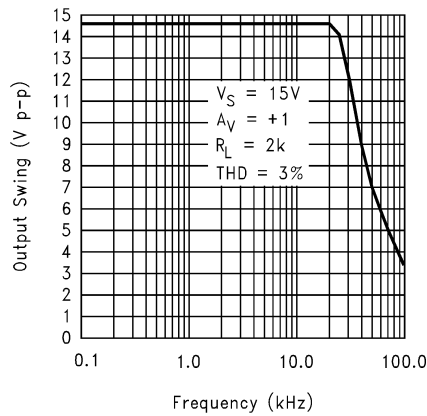

Gain and Phase vs. Capacitive Load

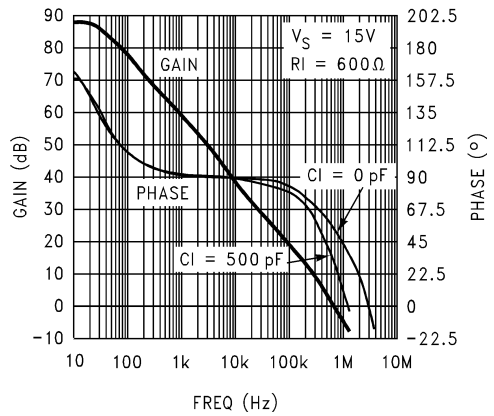

15V Typical Performance Characteristics $V^+ = +15V$, $V^- = 0V$, $T_A = 25^\circ C$, unless otherwise specified. (Continued)

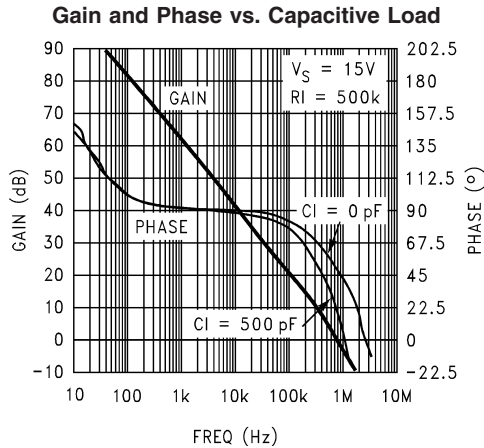

01199154

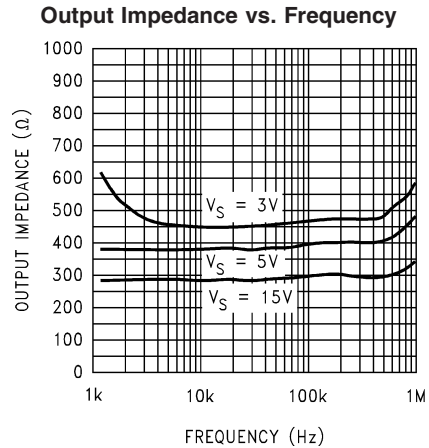

01199155

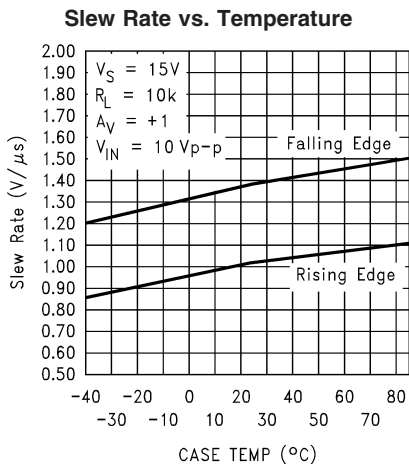

01199156

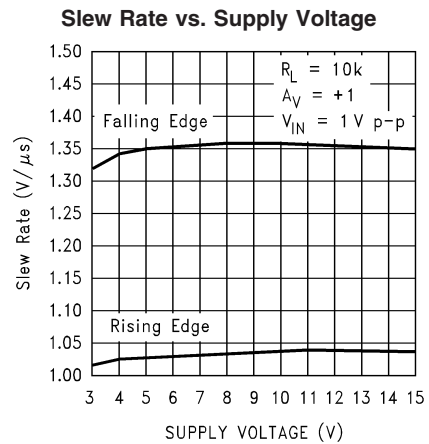

01199157

Inverting Small Signal Pulse Response

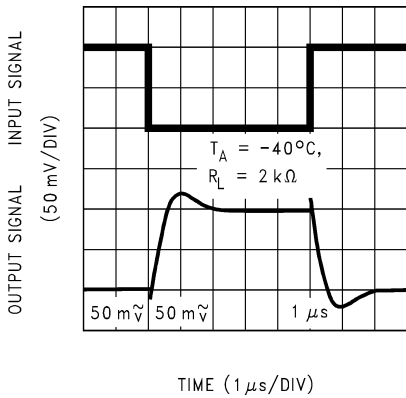

01199158

Inverting Small Signal Pulse Response

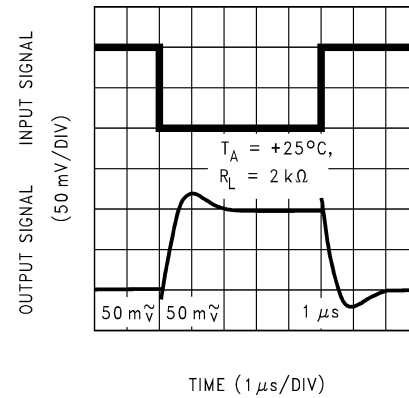

01199159

15V Typical Performance Characteristics $V^+ = +15V$, $V^- = 0V$, $T_A = 25^\circ C$, unless otherwise specified. (Continued)

Inverting Small Signal Pulse Response

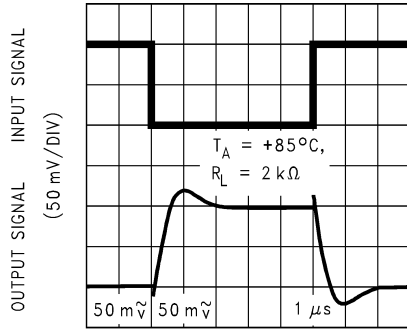

TIME (1 μs/DIV)

01199160

Inverting Large Signal Pulse Response

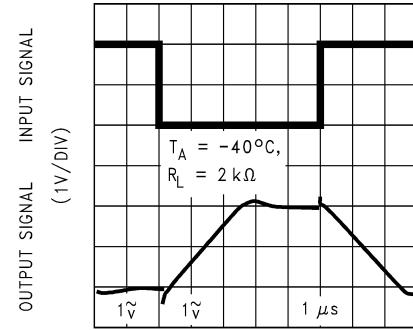

TIME (1 μs/DIV)

01199161

Inverting Large Signal Pulse Response

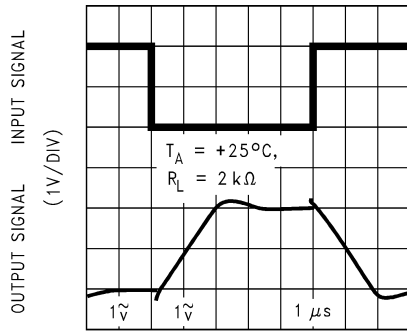

TIME (1 μs/DIV)

01199162

Inverting Large Signal Pulse Response

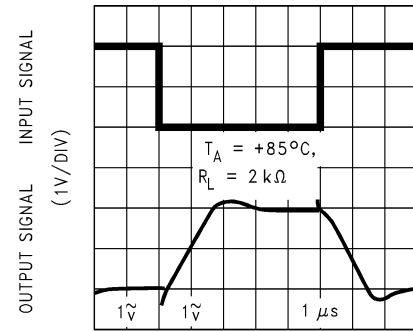

TIME (1 μs/DIV)

01199163

Non-Inverting Small Signal Pulse Response

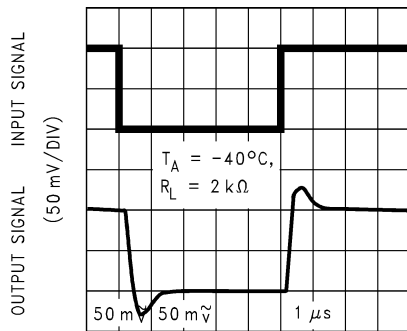

TIME (1 μs/DIV)

01199164

Non-Inverting Small Signal Pulse Response

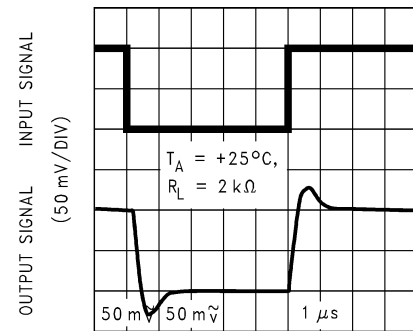

TIME (1 μs/DIV)

01199165

15V Typical Performance Characteristics $V^+ = +15V$, $V^- = 0V$, $T_A = 25^\circ C$, unless otherwise specified. (Continued)

Non-Inverting Small Signal Pulse Response

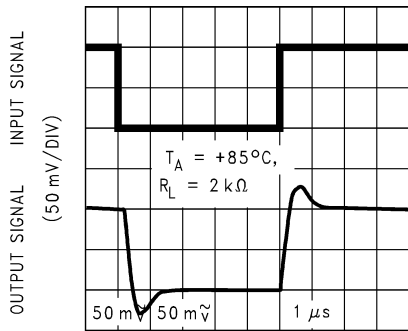

TIME (1 μs /DIV)

01199166

Non-Inverting Large Signal Pulse Response

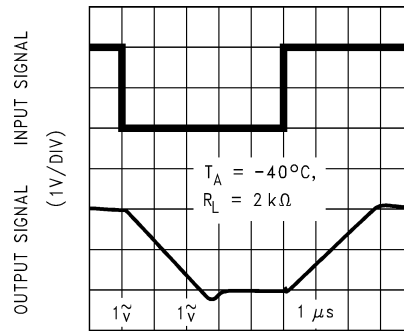

TIME (1 μs /DIV)

01199167

Non-Inverting Large Signal Pulse Response

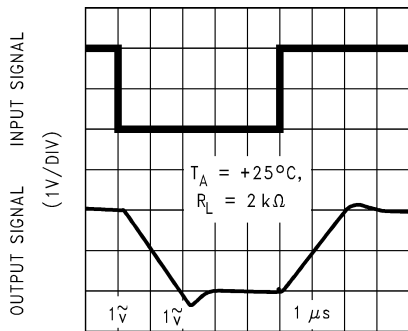

TIME (1 μs /DIV)

01199168

Non-Inverting Large Signal Pulse Response

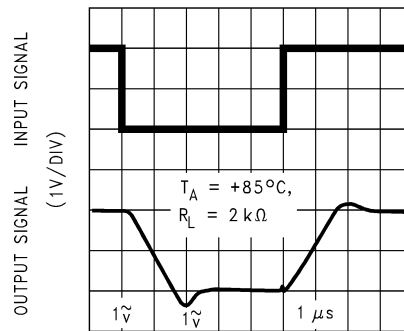

TIME (1 μs /DIV)

01199169

Stability vs. Capacitive Load

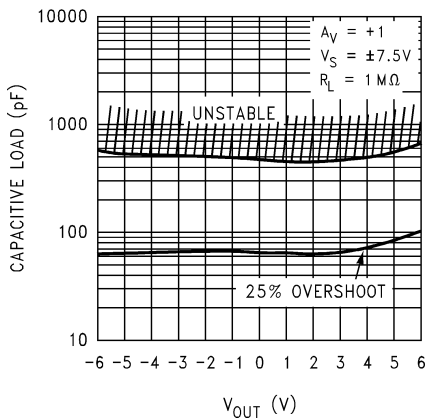

01199170

Stability vs. Capacitive Load

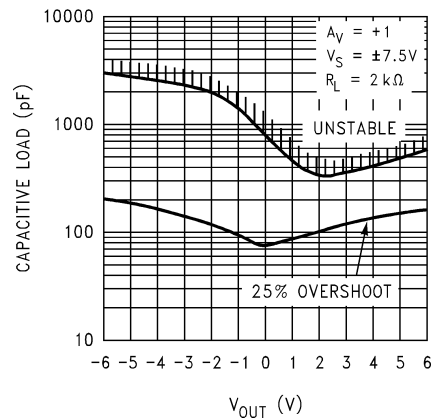

01199171

15V Typical Performance Characteristics $V^+ = +15V$, $V^- = 0V$, $T_A = 25^\circ C$, unless otherwise specified. (Continued)

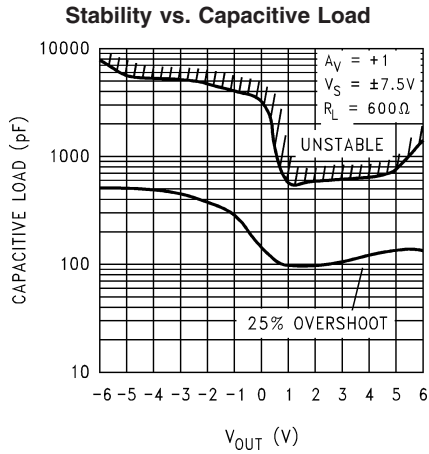

01199175

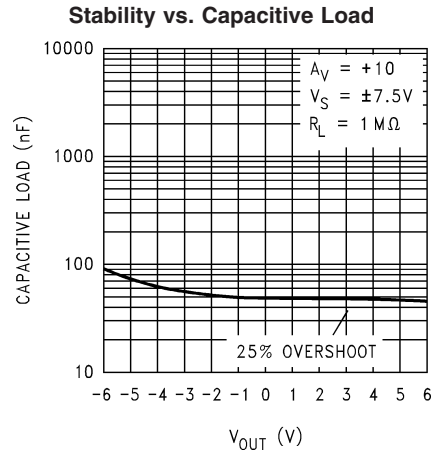

01199176

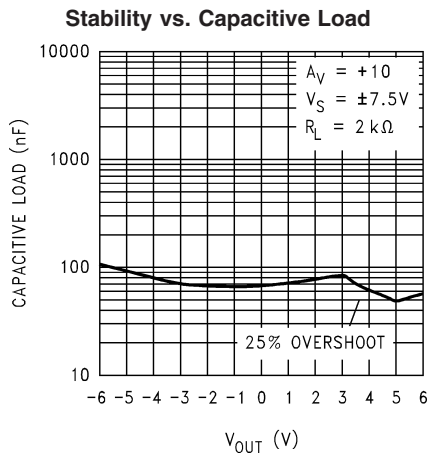

01199177

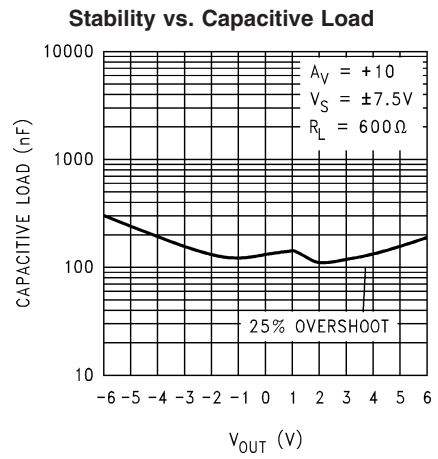

01199178

Application Information

1.0 BENEFITS OF THE LMC7101 TINY AMP

Size

The small footprint of the SOT 23-5 packaged Tiny amp, (0.120 x 0.118 inches, 3.05 x 3.00 mm) saves space on printed circuit boards, and enable the design of smaller electronic products. Because they are easier to carry, many customers prefer smaller and lighter products.

Height

The height (0.056 inches, 1.43 mm) of the Tiny amp makes it possible to use it in PCMCIA type III cards.

Signal Integrity

Signals can pick up noise between the signal source and the amplifier. By using a physically smaller amplifier package, the Tiny amp can be placed closer to the signal source, reducing noise pickup and increasing signal integrity. The Tiny amp can also be placed next to the signal destination, such as a buffer for the reference of an analog to digital converter.

Simplified Board Layout

The Tiny amp can simplify board layout in several ways. First, by placing an amp where amps are needed, instead of routing signals to a dual or quad device, long pc traces may be avoided.

By using multiple Tiny amps instead of duals or quads, complex signal routing and possibly crosstalk can be reduced.

Low THD

The high open loop gain of the LMC7101 amp allows it to achieve very low audio distortion—typically 0.01% at 10 kHz with a 10 k Ω load at 5V supplies. This makes the Tiny an excellent for audio, modems, and low frequency signal processing.

Low Supply Current

The typical 0.5 mA supply current of the LMC7101 extends battery life in portable applications, and may allow the reduction of the size of batteries in some applications.

Wide Voltage Range

The LMC7101 is characterized at 15V, 5V and 3V. Performance data is provided at these popular voltages. This wide voltage range makes the LMC7101 a good choice for devices where the voltage may vary over the life of the batteries.

2.0 INPUT COMMON MODE

Voltage Range

The LMC7101 does not exhibit phase inversion when an input voltage exceeds the negative supply voltage. *Figure 1* shows an input voltage exceeding both supplies with no resulting phase inversion of the output.

The absolute maximum input voltage is 300 mV beyond either rail at room temperature. Voltages greatly exceeding this maximum rating, as in *Figure 2*, can cause excessive current to flow in or out of the input pins, adversely affecting reliability.

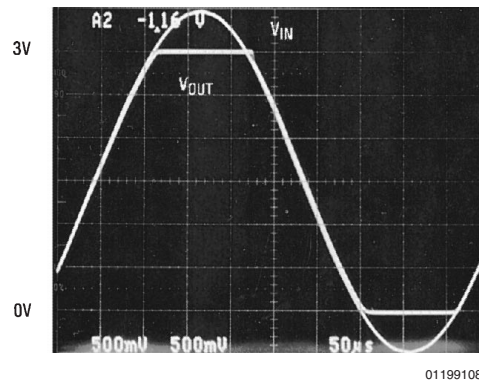

FIGURE 1. An Input Voltage Signal Exceeds the LMC7101 Power Supply Voltages with No Output Phase Inversion

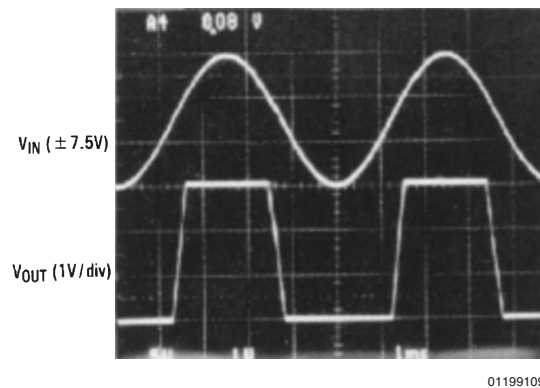

FIGURE 2. A $\pm 7.5V$ Input Signal Greatly Exceeds the 3V Supply in *Figure 3* Causing No Phase Inversion Due to R_I

Applications that exceed this rating must externally limit the maximum input current to ± 5 mA with an input resistor as shown in *Figure 3*.

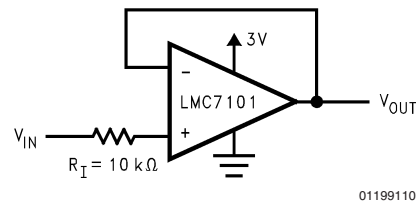

FIGURE 3. R_I Input Current Protection for Voltages Exceeding the Supply Voltage

3.0 RAIL-TO-RAIL OUTPUT

The approximate output resistance of the LMC7101 is 180 Ω sourcing and 130 Ω sinking at $V_S = 3V$ and 110 Ω sourcing and 80 Ω sinking at $V_S = 5V$. Using the calculated output resistance, maximum output voltage swing can be estimated as a function of load.

Application Information (Continued)

4.0 CAPACITIVE LOAD TOLERANCE

The LMC7101 can typically directly drive a 100 pF load with $V_S = 15V$ at unity gain without oscillating. The unity gain follower is the most sensitive configuration. Direct capacitive loading reduces the phase margin of op-amps. The combination of the op-amp's output impedance and the capacitive load induces phase lag. This results in either an under-damped pulse response or oscillation.

Capacitive load compensation can be accomplished using resistive isolation as shown in *Figure 4*. This simple technique is useful for isolating the capacitive input of multiplexers and A/D converters.

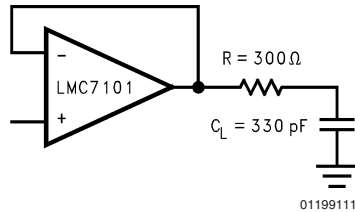

FIGURE 4. Resistive Isolation of a 330 pF Capacitive Load

5.0 COMPENSATING FOR INPUT CAPACITANCE WHEN USING LARGE VALUE FEEDBACK RESISTORS

When using very large value feedback resistors, (usually $> 500 k\Omega$) the large feedback resistance can react with the input capacitance due to transducers, photodiodes, and circuit board parasitics to reduce phase margins.

The effect of input capacitance can be compensated for by adding a feedback capacitor. The feedback capacitor (as in *Figure 5*), C_f is first estimated by:

$$\frac{1}{2\pi R_1 C_{IN}} \geq \frac{1}{2\pi R_2 C_f}$$

or

$$R_1 C_{IN} \leq R_2 C_f$$

which typically provides significant overcompensation.

Printed circuit board stray capacitance may be larger or smaller than that of a breadboard, so the actual optimum value for C_f may be different. The values of C_f should be checked on the actual circuit. (Refer to the LMC660 quad CMOS amplifier data sheet for a more detailed discussion.)

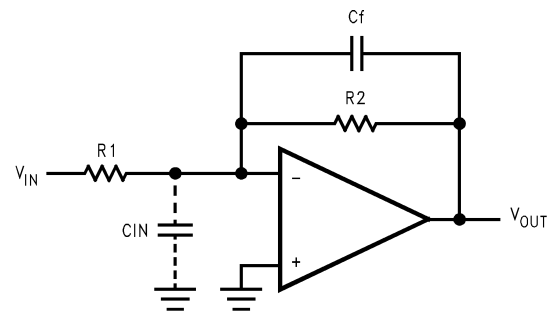

FIGURE 5. Cancelling the Effect of Input Capacitance

Application Information (Continued)

SOT-23-5 TAPE AND REEL SPECIFICATION

Tape Format

Tape Section	# Cavities	Cavity Status	Cover Tape Status
Leader (Start End)	0 (min)	Empty	Sealed
	75 (min)	Empty	Sealed
Carrier	3000	Filled	Sealed
	1000	Filled	Sealed
Trailer (Hub End)	125 (min)	Empty	Sealed
	0 (min)	Empty	Sealed

Tape Dimensions

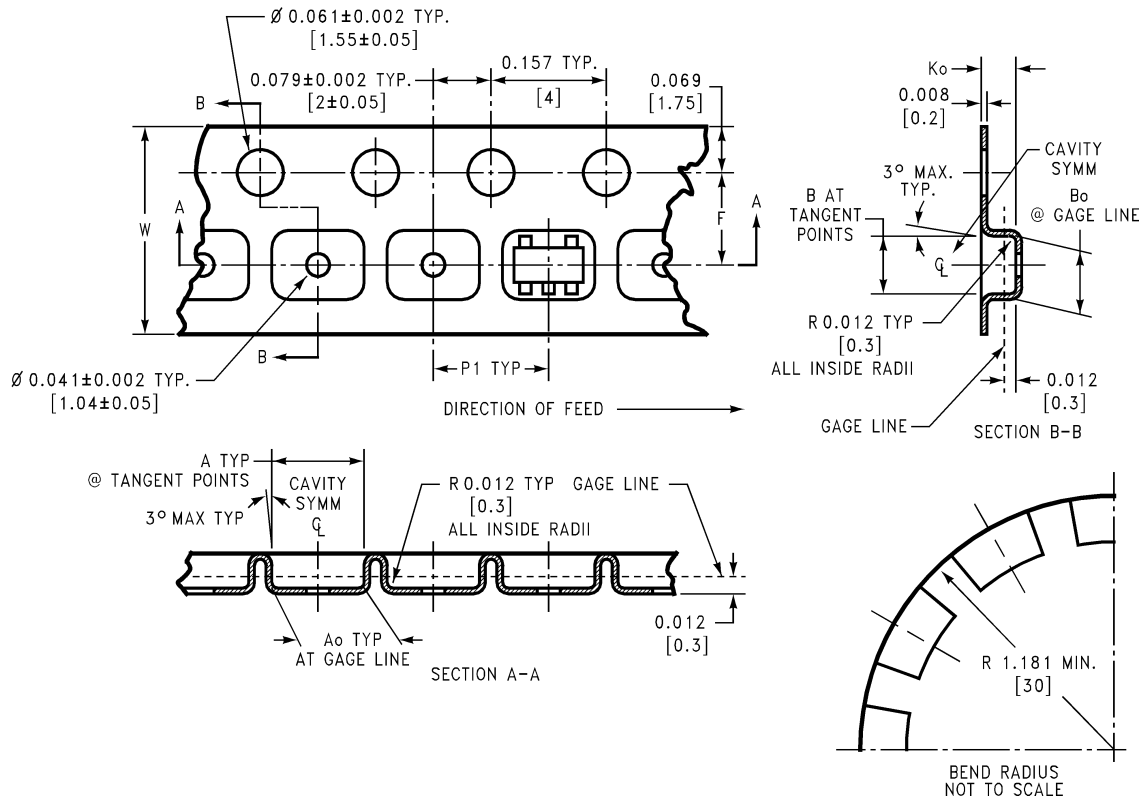

8 mm	0.130 (3.3)	0.124 (3.15)	0.130 (3.3)	0.126 (3.2)	0.138 ± 0.002 (3.5 ± 0.05)	0.055 ± 0.004 (1.4 ± 0.11)	0.157 (4)	0.315 ± 0.012 (8 ± 0.3)
Tape Size	DIM A	DIM A ₀	DIM B	DIM B ₀	DIM F	DIM K ₀	DIM P1	DIM W

Application Information (Continued)

Reel Dimensions

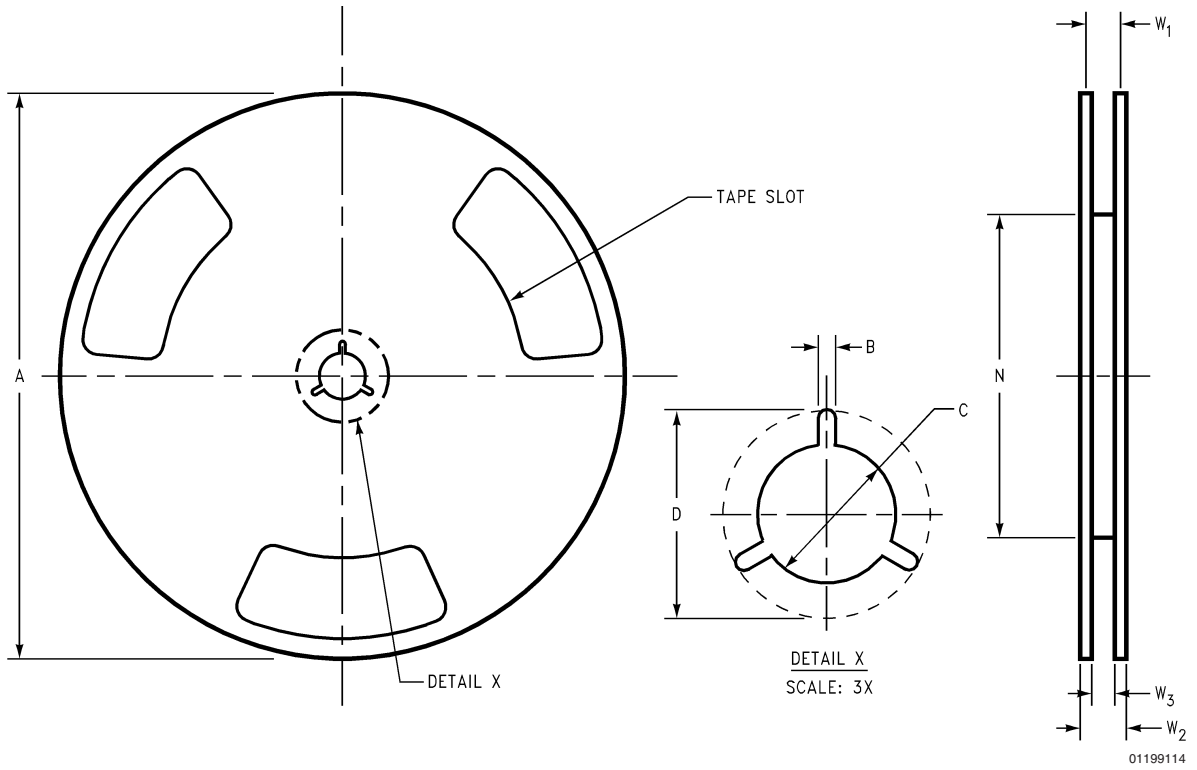

8 mm	7.00	0.059	0.512	0.795	2.165	0.331 + 0.059/-0.000	0.567	W1 + 0.078/-0.039
	330.00	1.50	13.00	20.20	55.00	8.40 + 1.50/-0.00	14.40	W1 + 2.00/-1.00
Tape Size	A	B	C	D	N	W1	W2	W3

Physical Dimensions inches (millimeters) unless otherwise noted

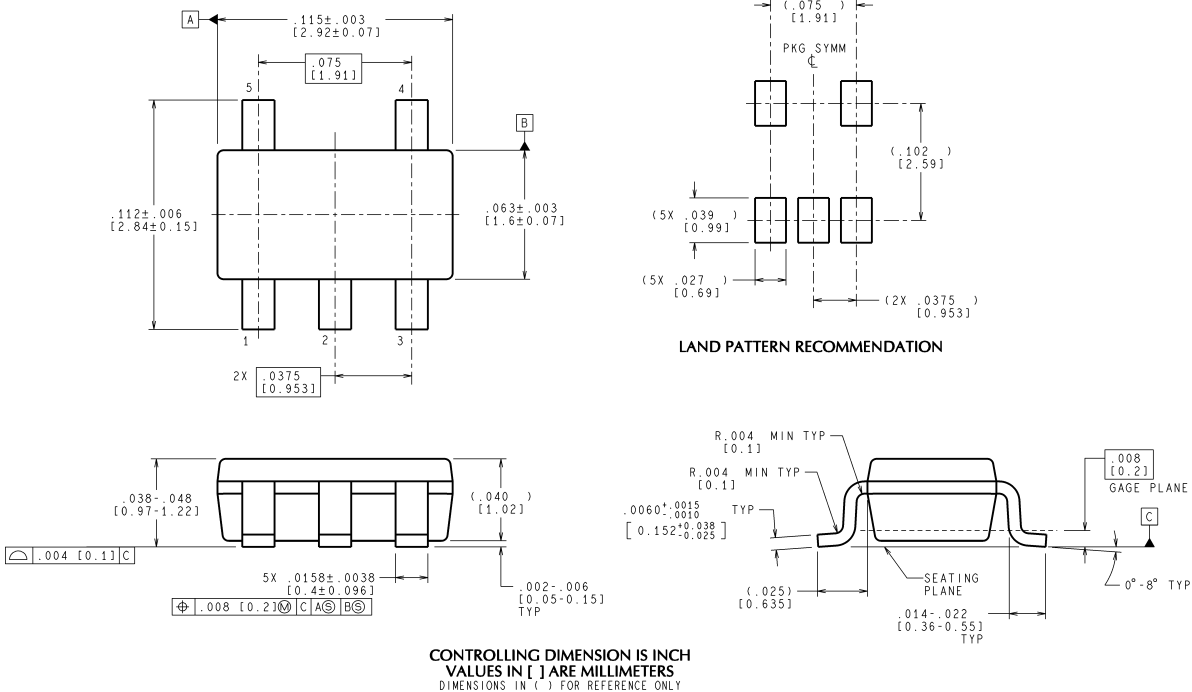

**5-Pin SOT23 Package
NS Package Number MF05A**

National does not assume any responsibility for use of any circuitry described, no circuit patent licenses are implied and National reserves the right at any time without notice to change said circuitry and specifications.
For the most current product information visit us at www.national.com.

LIFE SUPPORT POLICY

NATIONAL'S PRODUCTS ARE NOT AUTHORIZED FOR USE AS CRITICAL COMPONENTS IN LIFE SUPPORT DEVICES OR SYSTEMS WITHOUT THE EXPRESS WRITTEN APPROVAL OF THE PRESIDENT AND GENERAL COUNSEL OF NATIONAL SEMICONDUCTOR CORPORATION. As used herein:

1. Life support devices or systems are devices or systems which, (a) are intended for surgical implant into the body, or (b) support or sustain life, and whose failure to perform when properly used in accordance with instructions for use provided in the labeling, can be reasonably expected to result in a significant injury to the user.
2. A critical component is any component of a life support device or system whose failure to perform can be reasonably expected to cause the failure of the life support device or system, or to affect its safety or effectiveness.

BANNED SUBSTANCE COMPLIANCE

National Semiconductor manufactures products and uses packing materials that meet the provisions of the Customer Products Stewardship Specification (CSP-9-111C2) and the Banned Substances and Materials of Interest Specification (CSP-9-111S2) and contain no "Banned Substances" as defined in CSP-9-111S2.

Leadfree products are RoHS compliant.

<p>National Semiconductor Americas Customer Support Center Email: new.feedback@nsc.com Tel: 1-800-272-9959</p>	<p>National Semiconductor Europe Customer Support Center Fax: +49 (0) 180-530 85 86 Email: europe.support@nsc.com Deutsch Tel: +49 (0) 69 9508 6208 English Tel: +44 (0) 870 24 0 2171 Français Tel: +33 (0) 1 41 91 8790</p>	<p>National Semiconductor Asia Pacific Customer Support Center Email: ap.support@nsc.com</p>	<p>National Semiconductor Japan Customer Support Center Fax: 81-3-5639-7507 Email: jpn.feedback@nsc.com Tel: 81-3-5639-7560</p>
---	--	---	--

www.national.com