

LMV712

Low Power, Low Noise, High Output, RRIO Dual Operational Amplifier with Independent Shutdown

General Description

The LMV712 duals are high performance BiCMOS operational amplifiers intended for applications requiring Rail-to-Rail inputs combined with speed and low noise. They offer a bandwidth of 5MHz and a slew rate of 5 V/ μ s and can handle capacitive loads of up to 200pF without oscillation.

The LMV712 is guaranteed to operate from 2.7V to 5.5V and offers two independent shutdown pins. This feature allows disabling of each device separately and reduces the supply current to less than 1 μ A typical. The output voltage rapidly ramps up smoothly with no glitch as the amplifier comes out of the shutdown mode.

The LMV712 with the shutdown feature is offered in space saving 10-Bump micro SMD and 10-Pin Leadless Leadframe Package (LLP) packages. It is also offered in 10-Pin MSOP package. These packages are designed to meet the demands of small size, low power, and low cost required by cellular phones and similar battery operated portable electronics.

Features

(Typical Unless Otherwise Noted)

- 5MHz GBP
- Slew rate 5V/ μ s
- Low noise 20nV/ \sqrt Hz
- Supply current 1.22mA/channel
- $V_{OS} < 3mV$ max.
- Guaranteed 2.7V and 5V specifications
- Rail-to-Rail inputs and outputs.
- Unity gain stable.
- Small package: 10-Pin LLP, 10-Pin MSOP and 10-Bump micro SMD
- 1.5 μ A shutdown I_{CC}
- 2.2 μ s turn on

Applications

- Power amplifier control loop
- Cellular phones
- Portable equipment
- Wireless LAN
- Radio systems
- Cordless phones

Typical Application Circuit

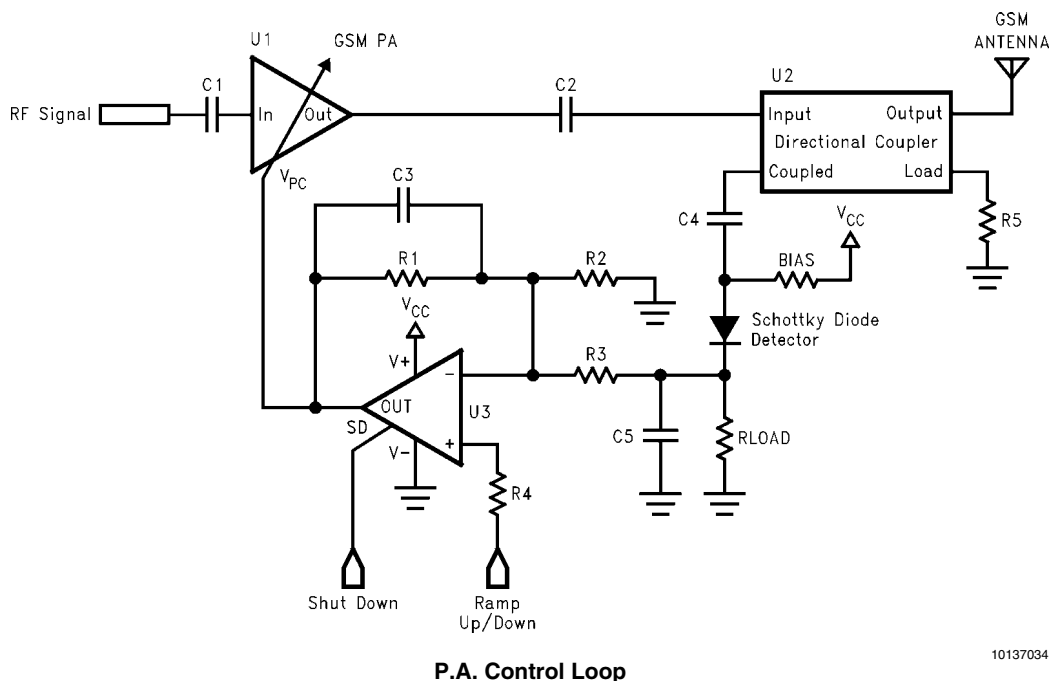

Absolute Maximum Ratings (Note 1)

If Military/Aerospace specified devices are required, please contact the National Semiconductor Sales Office/ Distributors for availability and specifications.

ESD Tolerance (Note 2)	
Human Body Model	1.5kV
Machine Model	150V
Differential Input Voltage	±Supply Voltage
Voltage at Input/Output Pin	(V+) +0.4V to (V-) -0.4V
Supply Voltage (V+ - V-)	6V
Output Short Circuit V+	(Note 3)
Output Short Circuit V-	(Note 3)
Current at Input Pin	±10mA
Current at Output Pin	±50mA

Storage Temp Range	-65°C to 150°C
Mounting Temperature	
Infrared or Convection (20 sec)	235°C
Junction Temperature T _{JMAX} (Note 4)	150°C

Recommended Operating Conditions (Note 1)

Supply Voltage	2.7V to 5.5V
Temperature Range	-40°C ≤ T _J ≤ 85°C
Thermal Resistance	
10-Pin MSOP	235°C/W
10-Pin LLP	53.4°C/W
10-Bump micro SMD	196°C/W

2.7V Electrical Characteristics Unless otherwise specified, all limits guaranteed for V+ = 2.7V, V- = 0V, V_{CM} = 1.35V and T_A = 25°C and R_L > 1MΩ. **Boldface** limits apply at the temperature extremes.

Symbol	Parameter	Condition	Min (Note 6)	Typ (Note 5)	Max (Note 6)	Units	
V _{OS}	Input Offset Voltage	V _{CM} = 0.85V and V _{CM} = 1.85V		MSOP LLP BL Packages	0.4	3 3.2	mV
				TL Package	3	7 9	
I _B	Input Bias Current			5.5	115 130	pA	
CMRR	Common Mode Rejection Ratio	0V ≤ V _{CM} ≤ 2.7V	50 45	75		dB	
PSRR	Power Supply Rejection Ratio	2.7V ≤ V+ ≤ 5V, V _{CM} = 0.85V	70 68	90		dB	
		2.7V ≤ V+ ≤ 5V, V _{CM} = 1.85V	70 68	90		dB	
CMVR	Common Mode Voltage Range	For CMRR ≥ 50dB		-0.3	-0.2	V	
				2.9	3		
I _{SC}	Output Short Circuit Current	Sourcing V _O = 0V	15 12	25		mA	
		Sinking V _O = 2.7V	25 22	50		mA	
V _O	Output Swing	R _L = 10kΩ to 1.35V		2.62 2.60	2.68	V	
					0.01	0.12 0.15	V
		R _L = 600Ω to 1.35V		2.52 2.50	2.55		V
					0.05	0.23 0.30	V
V _{O(SD)}	Output Voltage in Shutdown			10	200	mV	
I _S	Supply Current per Channel	On Mode		1.22	1.7 1.9	mA	
		Shutdown Mode		0.12	1.5 2.0	uA	

Symbol	Parameter	Condition	Min (Note 6)	Typ (Note 5)	Max (Note 6)	Units
A _{VOL}	Large Signal Voltage Gain	Sourcing R _L = 10kΩ V _O = 1.35V to 2.3V	80 76	115		dB
		Sinking R _L = 10kΩ V _O = 0.4V to 1.35V	80 76	113		dB
		Sourcing R _L = 600Ω V _O = 1.35V to 2.2V	80 76	97		dB
		Sinking R _L = 600Ω V _O = 0.5V to 1.35V	80 76	100		dB
V _{SD}	Shutdown Pin Voltage Range	On Mode	2.4 to 2.7	2.0 to 2.7		V
		Shutdown Mode	0 to 0.8	0 to 1		V
GBWP	Gain-Bandwidth Product			5		MHz
SR	Slew Rate	(Note 7)		5		V/μs
φ _m	Phase Margin			60		Deg
e _n	Input Referred Voltage Noise	f = 1kHz		20		nV/√Hz
T _{ON}	Turn-On Time from Shutdown			2.2	4 4.6	μs
	Turn-On Time from Shutdown	micro SMD	6 8			μs

5V Electrical Characteristics

Unless otherwise specified, all limits guaranteed for V⁺ = 5V, V⁻ = 0V, V_{CM} = 2.5V and T_A = 25°C and R_L > 1MΩ. **Boldface** limits apply at the temperature extremes.

Symbol	Parameter	Condition	Min (Note 6)	Typ (Note 5)	Max (Note 6)	Units	
V _{OS}	Input Offset Voltage	V _{CM} = 0.85V and V _{CM} = 1.85V	MSOP LLP BL Packages		0.4	3 3.2	mV
			TL Package		3	7 9	
I _B	Input Bias Current			5.5	115 130	pA	
CMRR	Common Mode Rejection Ratio	0V ≤ V _{CM} ≤ 5V	50 45	80		dB	
PSRR	Power Supply Rejection Ratio	2.7V ≤ V ⁺ ≤ 5V, V _{CM} = 0.85V	70 68	90		dB	
		2.7V ≤ V ⁺ ≤ 5V, V _{CM} = 1.85V	70 68	90		dB	
CMVR	Common Mode Voltage Range	For CMRR ≥ 50dB		-0.3	-0.2	V	
			5.2	5.3		V	
I _{SC}	Output Short Circuit Current	Sourcing V _O = 0V	20 18	35		mA	
		Sinking V _O = 5V	25 21	50		mA	

Symbol	Parameter	Condition	Min (Note 6)	Typ (Note 5)	Max (Note 6)	Units
V_O	Output Swing	$R_L = 10k\Omega$ to 2.5V	4.92 4.90	4.98		V
				0.01	0.12 0.15	V
		$R_L = 600\Omega$ to 2.5V	4.82 4.80	4.85		V
				0.05	0.23 0.30	V
$V_O(SD)$	Output Voltage in Shutdown			10	200	mV
I_S	Supply Current per Channel	On Mode		1.17	1.7 1.9	mA
		Shutdown Mode		0.12	1.5 2.0	μ A
A_{VOL}	Large Signal Voltage Gain	Sourcing $R_L = 10k\Omega$ $V_O = 2.5V$ to 4.6V	80 76	130		dB
		Sinking $R_L = 10k\Omega$ $V_O = 0.4V$ to 2.5V	80 76	130		dB
		Sourcing $R_L = 600\Omega$ $V_O = 2.5V$ to 4.6V	80 76	110		dB
		Sinking $R_L = 600\Omega$ $V_O = 0.4V$ to 2.5V	80 76	107		dB
V_{SD}	Shutdown Pin Voltage Range	On Mode	4.5 to 5	3.5 to 5		V
		Shutdown Mode	0 to 0.8	0 to 1.5		V
GBWP	Gain-Bandwidth Product			5		MHz
SR	Slew Rate	(Note 7)		5		V/ μ s
ϕ_m	Phase Margin			60		Deg
e_n	Input Referred Voltage Noise	$f = 1kHz$		20		nV/\sqrt{Hz}
T_{ON}	Turn-On Time for Shutdown			1.6	4 4.6	μ s
	Turn-On Time for Shutdown	micro SMD	6 8			μ s

Note 1: Absolute Maximum Ratings indicate limits beyond which damage to the device may occur. Operating Ratings indicate conditions for which the device is intended to be functional, but specific performance is not guaranteed. For guaranteed specifications and the test conditions, see the Electrical Characteristics.

Note 2: Human Body Model, applicable std. MIL-STD-883, Method 3015.7. Machine Model, applicable std. JESD22-A115-A (ESD MM std. of JEDEC). Field-Induced Charge-Device Model, applicable std. JESD22-C101-C (ESD FICDM std. of JEDEC).

Note 3: Shorting circuit output to either V^+ or V^- will adversely affect reliability.

Note 4: The maximum power dissipation is a function of $T_{J(MAX)}$, θ_{JA} . The maximum allowable power dissipation at any ambient temperature is $P_D = (T_{J(MAX)} - T_A) / \theta_{JA}$. All numbers apply for packages soldered directly onto a PC Board.

Note 5: Typical values represent the most likely parametric norm as determined at the time of characterization. Actual typical values may vary over time and will also depend on the application and configuration. The typical values are not tested and are not guaranteed on shipped production material.

Note 6: All limits are guaranteed by testing or statistical analysis.

Note 7: Number specified is the slower of the positive and negative slew rates.

Typical Performance Characteristics

Unless otherwise specified, $V_S = +5V$, single supply, $T_A = 25^\circ C$.

Supply Current Per Channel vs. Supply Voltage

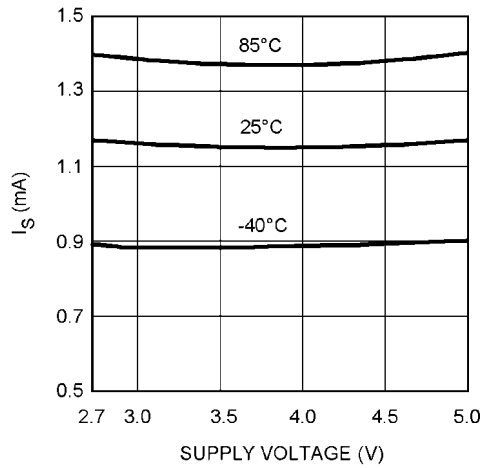

10137001

Supply Current vs. Supply Voltage (Shutdown)

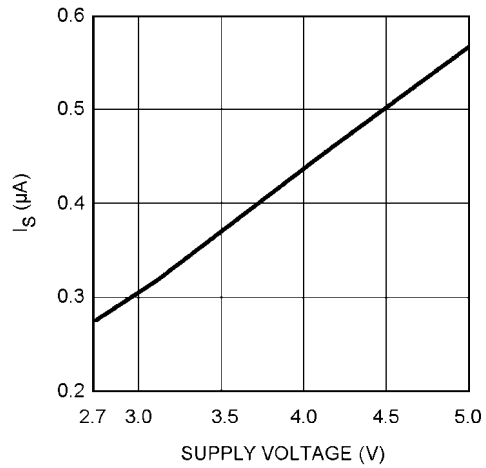

10137002

V_{OS} vs. V_{CM}

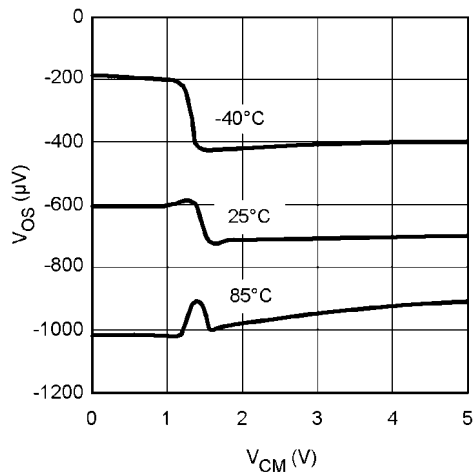

10137003

I_B vs. V_{CM} Over Temp

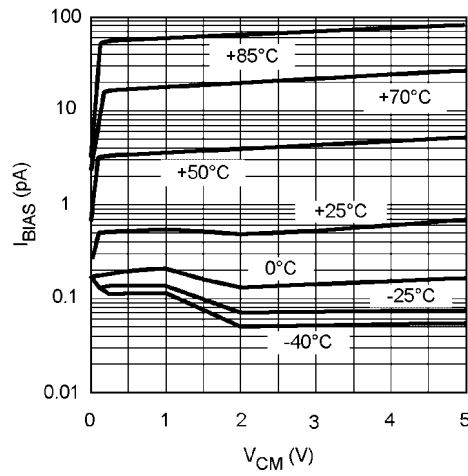

10137005

Output Positive Swing vs. Supply Voltage, $R_L = 600\Omega$

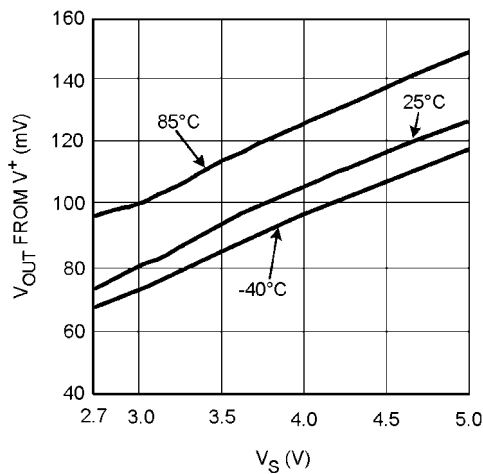

10137006

Output Negative Swing vs. Supply Voltage, $R_L = 600\Omega$

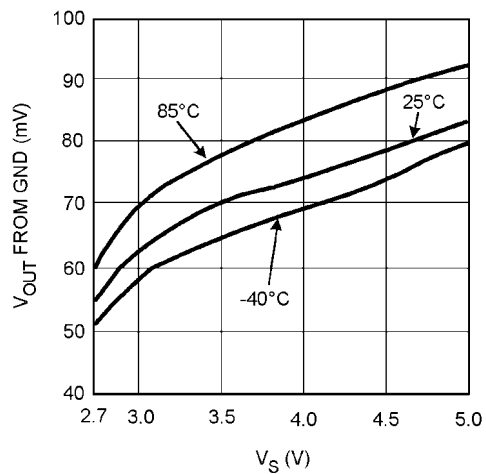

10137007

Sourcing Current vs. Output Voltage, $V_S = 2.7V$

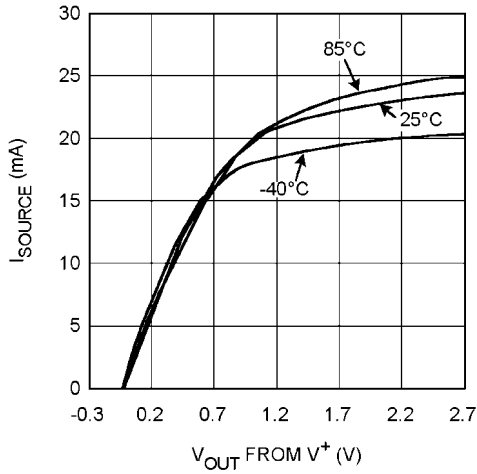

10137008

Sourcing Current vs. Output Voltage, $V_S = 5V$

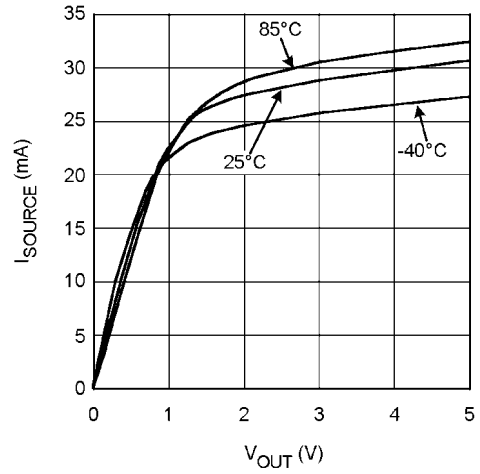

10137010

Sinking Current vs. Output Voltage, $V_S = 2.7V$

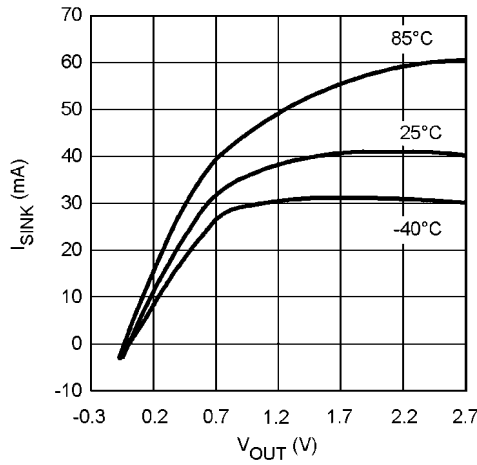

10137009

Sinking Current vs. Output Voltage, $V_S = 5V$

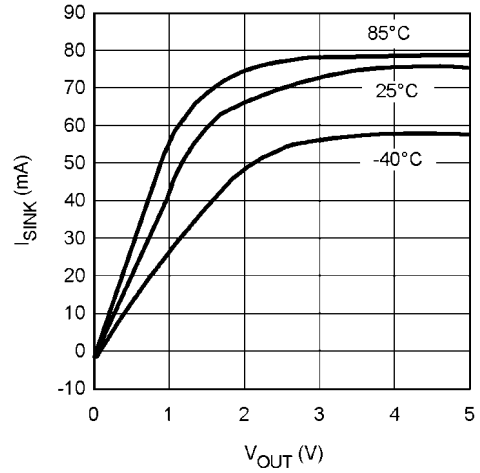

10137011

PSRR vs. Frequency $V_S = 2.7V$

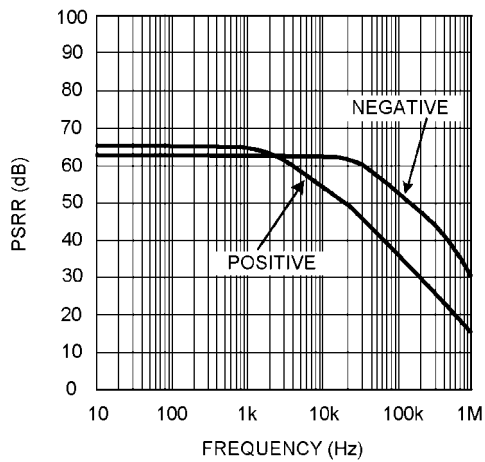

10137018

PSRR vs. Frequency $V_S = 5V$

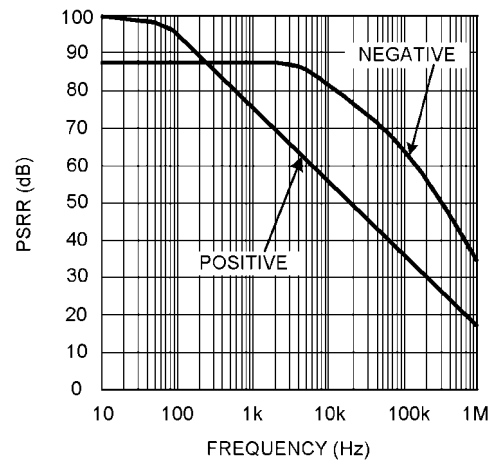

10137019

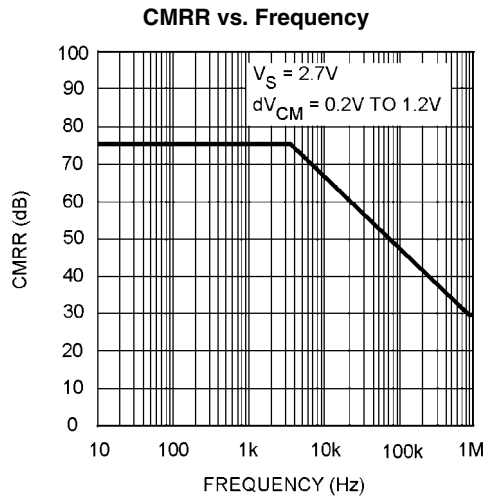

10137016

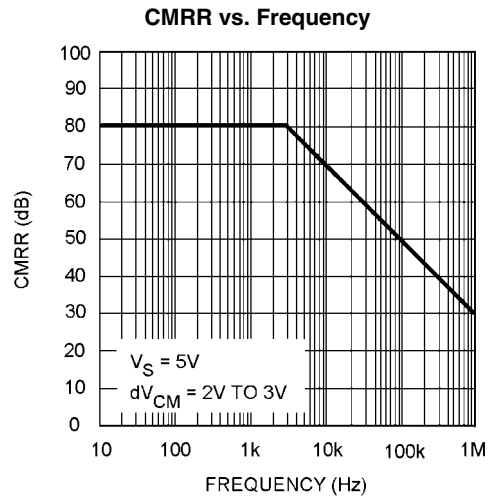

10137017

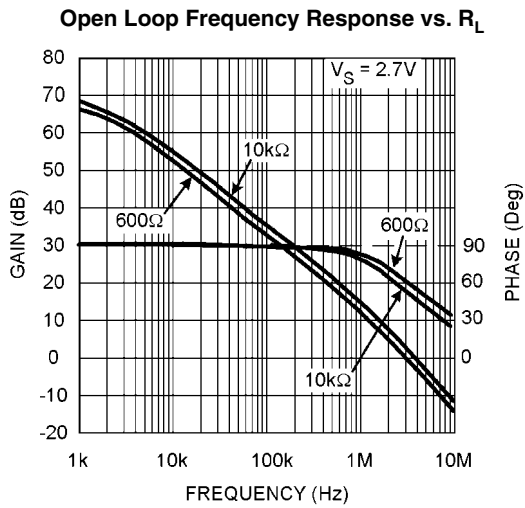

10137012

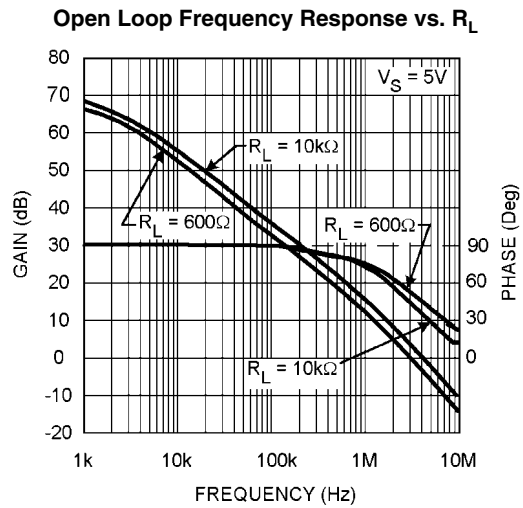

10137014

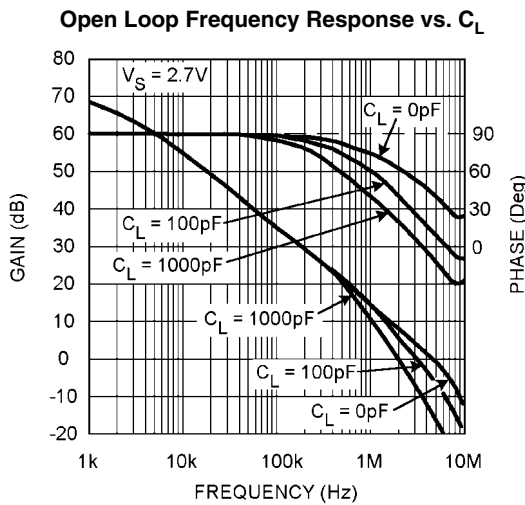

10137013

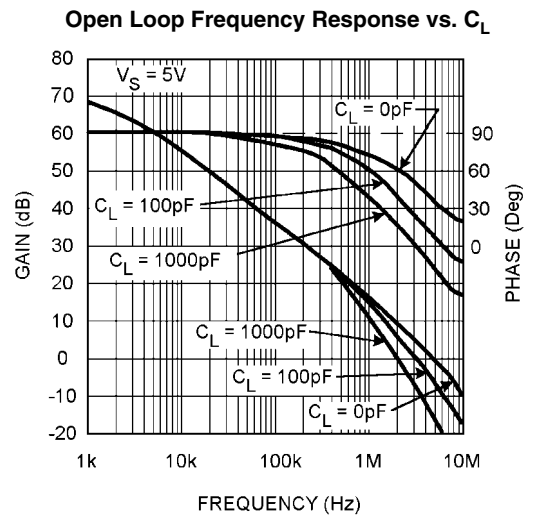

10137015

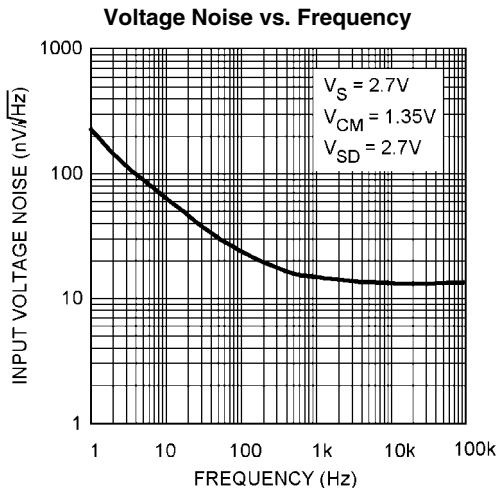

10137020

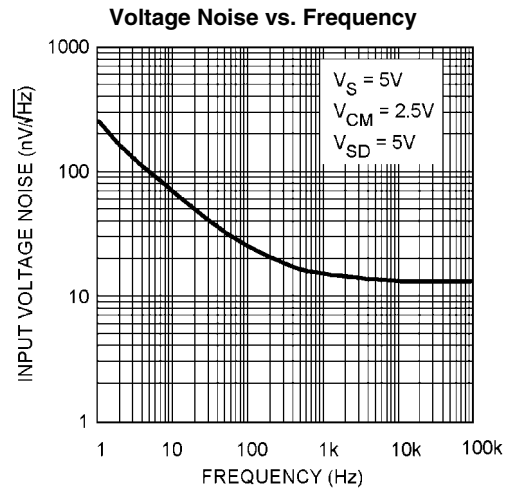

10137021

Non-Inverting Large Signal Pulse Response, $V_S = 2.7V$

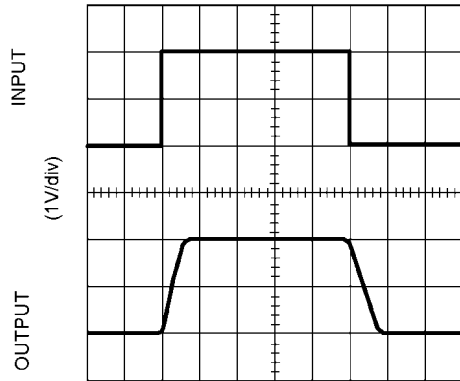

TIME (500ns/div)

10137022

Non-Inverting Large Signal Pulse Response, $V_S = 5V$

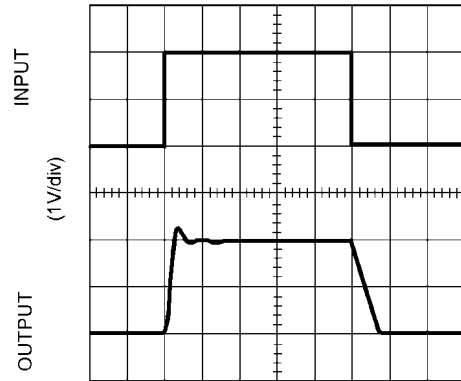

TIME (500ns/div)

10137024

Non-Inverting Small Signal Pulse Response, $V_S = 2.7V$

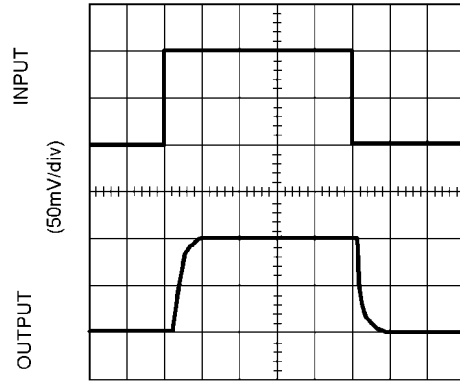

TIME (500ns/div)

10137023

Non-Inverting Small Signal Pulse Response, $V_S = 5V$

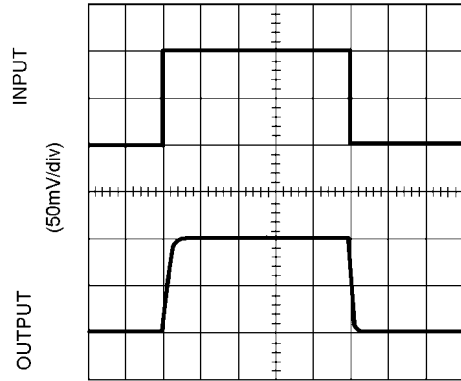

TIME (500ns/div)

10137025

Inverting Large Signal Pulse Response, $V_S = 2.7V$

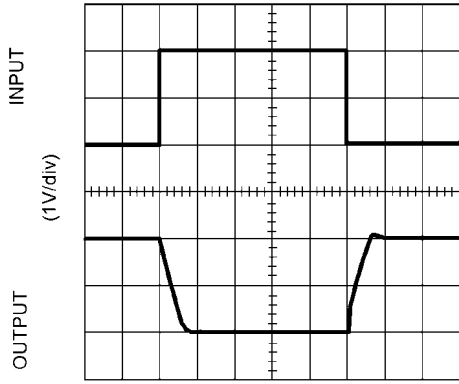

TIME (500ns/div)

10137026

Inverting Large Signal Pulse Response, $V_S = 5V$

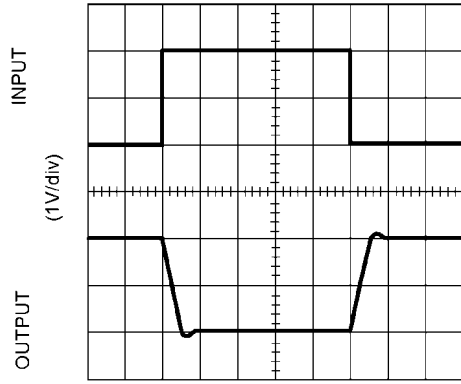

TIME (500ns/div)

10137028

Inverting Small Signal Pulse Response, $V_S = 2.7V$

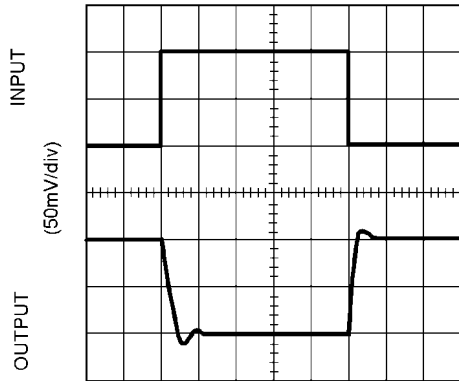

TIME (500ns/div)

10137027

Inverting Small Signal Pulse Response $V_S = 5V$

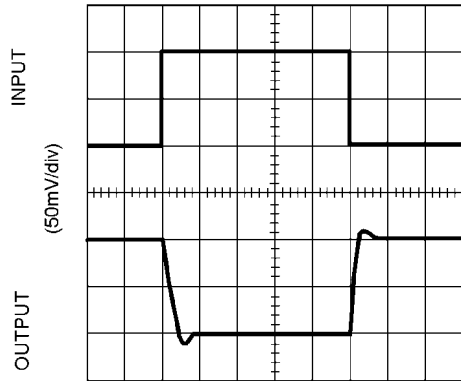

TIME (500ns/div)

10137029

Turn on Time Response $V_S = 5V$

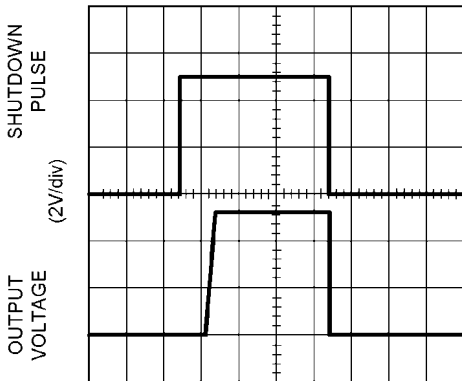

TIME (2µs/div)

10137030

Input Common Mode Capacitance vs. V_{CM} $V_S = 5V$

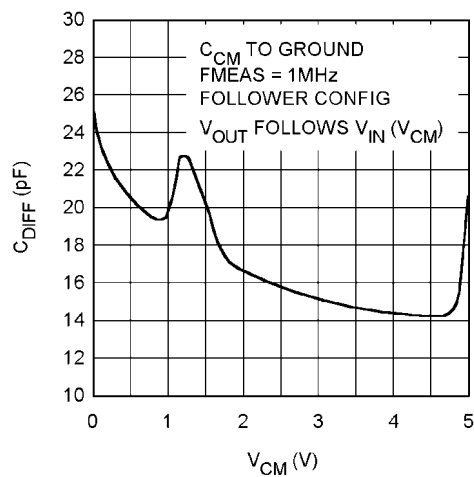

10137004

Application Information

THEORY OF OPERATION

The LMV712 dual op amp is derived from the LMV711 single op amp. *Figure 1* contains a simplified schematic of one channel of the LMV712.

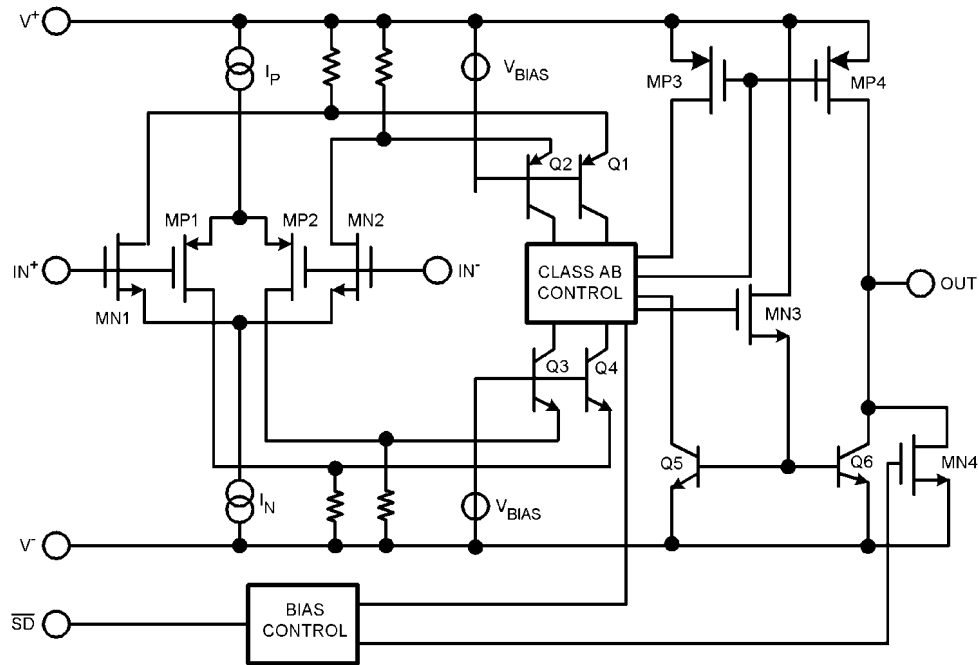

10137031

FIGURE 1.

Rail-to-Rail input is achieved by using in parallel, one NMOS differential pair (MN1 and MN2) and one PMOS differential pair (MP1 and MP2). When the common mode input voltage (V_{CM}) is near V^+ , the NMOS pair is on and the PMOS pair is off. When V_{CM} is near V^- , the NMOS pair is off and the PMOS pair is on. When V_{CM} is between V^+ and V^- , internal logic decides how much current each differential pair will get. This special logic ensures stable and low distortion amplifier operation within the entire common mode voltage range.

Because both input stages have their own offset voltage (V_{OS}) characteristic, the offset voltage of the LMV712 becomes a function of V_{CM} . V_{OS} has a crossover point at 1.4V above V^- . Refer to the " V_{OS} vs. V_{CM} " curve in the Typical Performance Characteristics section. Caution should be taken in situations where input signal amplitude is comparable to V_{OS} value and/or the design requires high accuracy. In these situations, it is necessary for the input signal to avoid the crossover point.

The current coming out of the input differential pairs gets mirrored through two folded cascode stages (Q1, Q2, Q3, Q4) into the "class AB control" block. This circuitry generates voltage gain, defines the op amp's dominant pole and limits the maximum current flowing at the output stage. MN3 introduces a voltage level shift and acts as a high impedance to low impedance buffer.

The output stage is composed of a PMOS and a NPN transistor in a common source/emitter configuration, delivering a rail-to-rail output excursion.

The MN4 transistor ensures that the LMV712 output remains near V^- when the amplifier is in shutdown mode.

SHUTDOWN PIN

The LMV712 offers independent shutdown pins for the dual amplifiers. When the shutdown pin is tied low, the respective amplifier shuts down and the supply current is reduced to less than $1\mu\text{A}$. In shutdown mode, the amplifier's output level stays at V^- . In a 2.7V operation, when a voltage between 1.5V to 2.7V is applied to the shutdown pin, the amplifier is enabled. As the amplifier is coming out of the shutdown mode, the output waveform ramps up without any glitch. This is demonstrated in *Figure 2*.

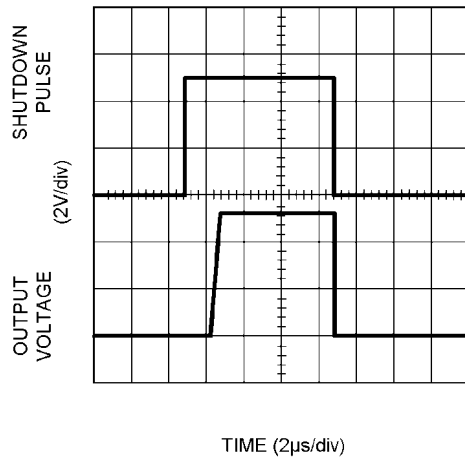

FIGURE 2.

A glitch-free output waveform is highly desirable in many applications, one of which is power amplifier control loops. In this application, the LMV712 is used to drive the power amplifier's power control. If the LMV712 did not have a smooth output ramp during turn on, it would directly cause the power amplifier to produce a glitch at its output. This adversely affects the performance of the system.

To enable the amplifier, the shutdown pin must be pulled high. It should not be left floating in the event that any leakage current may inadvertently turn off the amplifier.

PRINTED CIRCUIT BOARD CONSIDERATION

To properly bypass the power supply, several locations on a printed circuit board need to be considered. A 6.8µF or greater tantalum capacitor should be placed at the point where the power supply for the amplifier is introduced onto the board. Another 0.1µF ceramic capacitor should be placed as close as possible to the power supply pin of the amplifier. If the amplifier is operated in a single power supply, only the V⁺ pin needs to be bypassed with a 0.1µF capacitor. If the amplifier is operated in a dual power supply, both V⁺ and V⁻ pins need to be bypassed.

It is good practice to use a ground plane on a printed circuit board to provide all components with a low inductive ground connection.

Surface mount components in 0805 size or smaller are recommended in the LMV712 application circuits. Designers can take advantage of the micro SMD, MSOP and LLP miniature sizes to condense board layout in order to save space and reduce stray capacitance.

CAPACITIVE LOAD TOLERANCE

The LMV712 can directly drive 200pF in unity-gain without oscillation. The unity-gain follower is the most sensitive configuration to capacitive loading. Direct capacitive loading reduces the phase margin of amplifiers. The combination of the amplifier's output impedance and the capacitive load induces phase lag. This results in either an under-damped pulse re-

sponse or oscillation. To drive a heavier capacitive load, Figure 3 can be used.

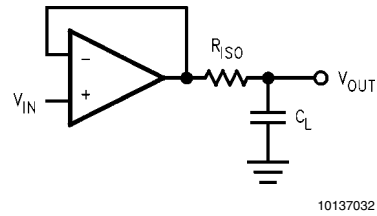

FIGURE 3.

In Figure 3, the isolation resistor R_{ISO} and the load capacitor C_L form a pole to increase stability by adding more phase margin to the overall system. The desired performance depends on the value of R_{ISO}. The bigger the R_{ISO} resistor value, the more stable V_{OUT} will be. But the DC accuracy is degraded when the R_{ISO} gets bigger. If there were a load resistor in Figure 3, the output voltage would be divided by R_{ISO} and the load resistor.

The circuit in Figure 4 is an improvement to the one in Figure 3 because it provides DC accuracy as well as AC stability. In this circuit, R_F provides the DC accuracy by using feed-forward techniques to connect V_{IN} to R_L. C_F and R_{ISO} serve to counteract the loss of phase margin by feeding the high frequency component of the output signal back to the amplifier's inverting input, thereby preserving phase margin in the overall feedback loop. Increased capacitive drive is possible by increasing the value of C_F. This in turn will slow down the pulse response.

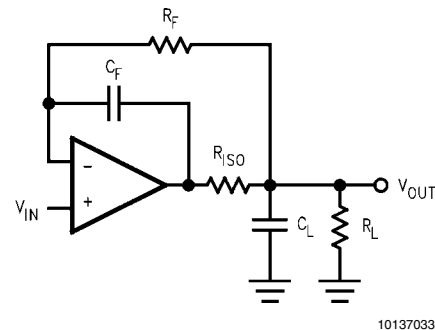
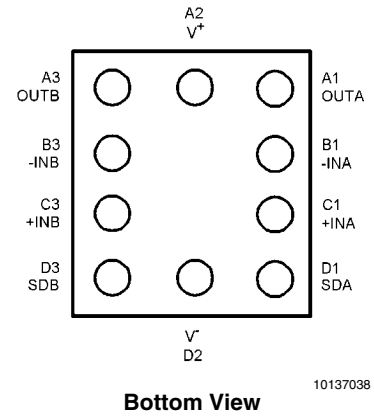
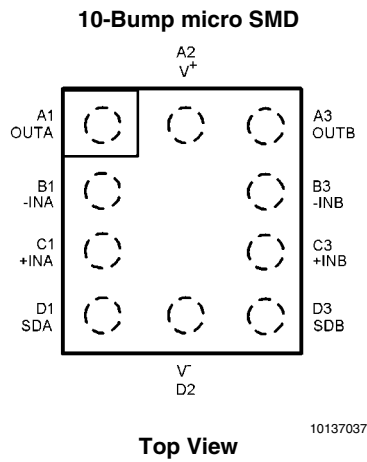
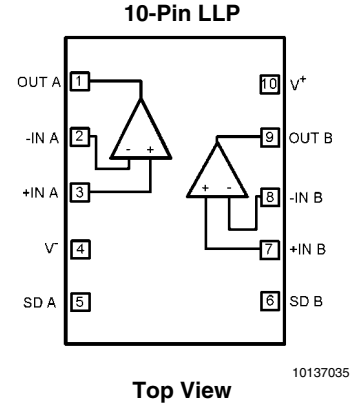
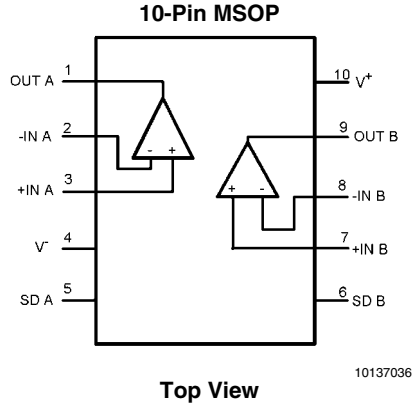

FIGURE 4.

LATCHUP

CMOS devices tend to be susceptible to latchup due to their internal parasitic SCR (silicon controlled rectifier) effects. The input and output pins look similar to the gate of the SCR. There is a minimum current required to trigger the SCR gate lead. The LMV712 is designed to withstand 150mA surge current on all the pins. Some resistive method should be used to isolate any capacitance from supplying excess current to the pins. In addition, like an SCR, there is a minimum holding current for any latchup mode. Limiting current to the supply pins will also inhibit latchup susceptibility.

Connection Diagrams



Ordering Information

Package	Part Number	Package Marking	Transport Media	NSC Drawing
10-Pin MSOP	LMV712MM	A61	1k Units Tape and Reel	MUB10A
	LMV712MMX		3.5k Units Tape and Reel	
10-Pin LLP	LMV712LD	A62	1k Units Tape and Reel	LDA10A
	LMV712LDX		4.5k Units Tape and Reel	
10-Bump micro SMD (PB)	LMV712BL	A76A	250 Units Tape and Reel	BLP10AAB 0.945mm thick
	LMV712BLX		3k Units Tape and Reel	
10-Bump micro SMD (NOPB)	LMV712TL	AU2A	250 Units Tape and Reel	TLP10BBA 0.600mm thick
	LMV712TLX		3k Units Tape and Reel	

Physical Dimensions inches (millimeters) unless otherwise noted

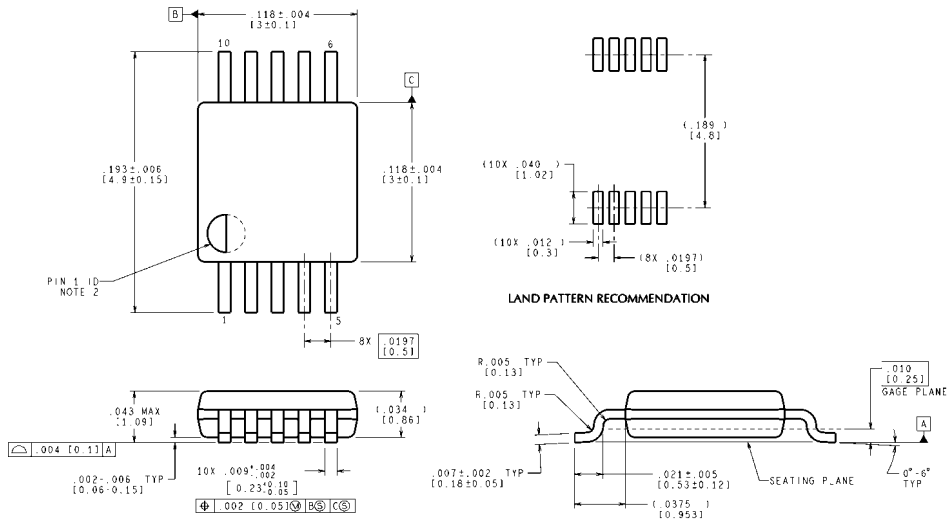

CONTROLLING DIMENSION IS INCH
 VALUES IN [] ARE MILLIMETERS
 DIMENSIONS IN [] FOR REFERENCE ONLY

10-Pin MSOP
NS Package Number MUB10A

MUB10A (Rev B)

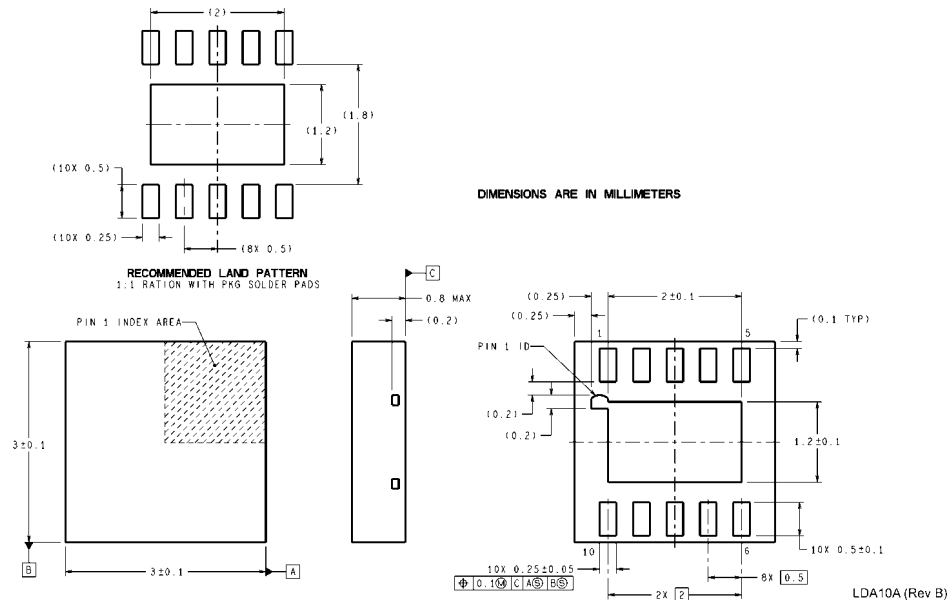

10-Pin LLP
NS Package Number LDA10A

LDA10A (Rev B)

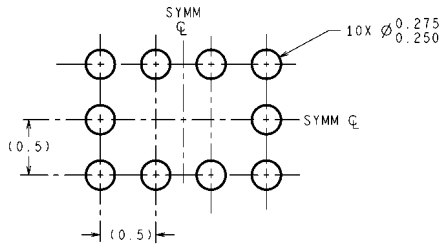

DIMENSIONS ARE IN MILLIMETERS
DIMENSIONS IN () FOR REFERENCE ONLY

LAND PATTERN RECOMMENDATION

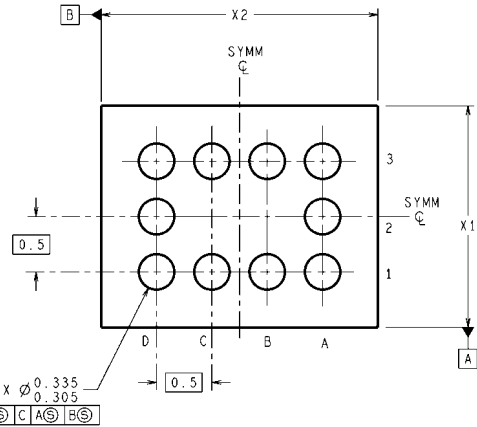
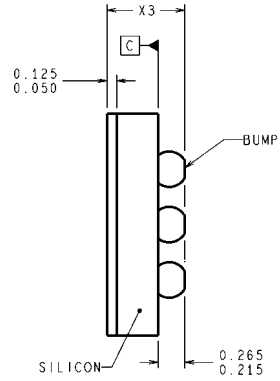
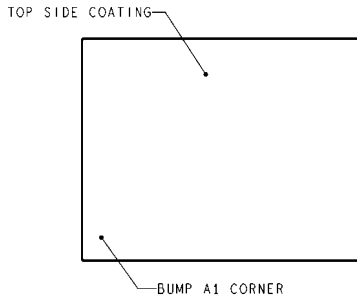

10X ϕ 0.335
0.305
C A B D

TLP10XXX (Rev D)

NOTES: UNLESS OTHERWISE SPECIFIED

1. EPOXY COATING
2. FOR SOLDER BUMP COMPOSITION. SEE "SOLDER INFORMATION" IN THE PACKAGING SECTION OF THE NATIONAL SEMICONDUCTOR WEB PAGE (www.national.com)
3. RECOMMEND NON-SOLDER MASK DEFINED LANDING PAD.
4. PIN A1 IS ESTABLISHED BY LOWER LEFT CORNER WITH RESPECT TO TEXT ORIENTATION.
5. XXX IN DRAWING NUMBER REPRESENTS PACKAGE SIZE VARIATION WHERE X1 IS PACKAGE WIDTH, X2 IS PACKAGE LENGTH AND X3 IS PACKAGE HEIGHT.
6. REFERENCE JEDEC REGISTRATION MO-211, VARIATION BD.

10-Bump micro SMD
NS Package Number TLP10BBA
X1 = 1.539 ±0.030mm X2 = 2.022 ±0.030mm X3 = 0.600 ±0.075mm

Notes

For more National Semiconductor product information and proven design tools, visit the following Web sites at:

Products		Design Support	
Amplifiers	www.national.com/amplifiers	WEBENCH	www.national.com/webench
Audio	www.national.com/audio	Analog University	www.national.com/AU
Clock Conditioners	www.national.com/timing	App Notes	www.national.com/appnotes
Data Converters	www.national.com/adc	Distributors	www.national.com/contacts
Displays	www.national.com/displays	Green Compliance	www.national.com/quality/green
Ethernet	www.national.com/ethernet	Packaging	www.national.com/packaging
Interface	www.national.com/interface	Quality and Reliability	www.national.com/quality
LVDS	www.national.com/lvds	Reference Designs	www.national.com/refdesigns
Power Management	www.national.com/power	Feedback	www.national.com/feedback
Switching Regulators	www.national.com/switchers		
LDOs	www.national.com/ldo		
LED Lighting	www.national.com/led		
PowerWise	www.national.com/powerwise		
Serial Digital Interface (SDI)	www.national.com/sdi		
Temperature Sensors	www.national.com/tempsensors		
Wireless (PLL/VCO)	www.national.com/wireless		

THE CONTENTS OF THIS DOCUMENT ARE PROVIDED IN CONNECTION WITH NATIONAL SEMICONDUCTOR CORPORATION ("NATIONAL") PRODUCTS. NATIONAL MAKES NO REPRESENTATIONS OR WARRANTIES WITH RESPECT TO THE ACCURACY OR COMPLETENESS OF THE CONTENTS OF THIS PUBLICATION AND RESERVES THE RIGHT TO MAKE CHANGES TO SPECIFICATIONS AND PRODUCT DESCRIPTIONS AT ANY TIME WITHOUT NOTICE. NO LICENSE, WHETHER EXPRESS, IMPLIED, ARISING BY ESTOPPEL OR OTHERWISE, TO ANY INTELLECTUAL PROPERTY RIGHTS IS GRANTED BY THIS DOCUMENT.

TESTING AND OTHER QUALITY CONTROLS ARE USED TO THE EXTENT NATIONAL DEEMS NECESSARY TO SUPPORT NATIONAL'S PRODUCT WARRANTY. EXCEPT WHERE MANDATED BY GOVERNMENT REQUIREMENTS, TESTING OF ALL PARAMETERS OF EACH PRODUCT IS NOT NECESSARILY PERFORMED. NATIONAL ASSUMES NO LIABILITY FOR APPLICATIONS ASSISTANCE OR BUYER PRODUCT DESIGN. BUYERS ARE RESPONSIBLE FOR THEIR PRODUCTS AND APPLICATIONS USING NATIONAL COMPONENTS. PRIOR TO USING OR DISTRIBUTING ANY PRODUCTS THAT INCLUDE NATIONAL COMPONENTS, BUYERS SHOULD PROVIDE ADEQUATE DESIGN, TESTING AND OPERATING SAFEGUARDS.

EXCEPT AS PROVIDED IN NATIONAL'S TERMS AND CONDITIONS OF SALE FOR SUCH PRODUCTS, NATIONAL ASSUMES NO LIABILITY WHATSOEVER, AND NATIONAL DISCLAIMS ANY EXPRESS OR IMPLIED WARRANTY RELATING TO THE SALE AND/OR USE OF NATIONAL PRODUCTS INCLUDING LIABILITY OR WARRANTIES RELATING TO FITNESS FOR A PARTICULAR PURPOSE, MERCHANTABILITY, OR INFRINGEMENT OF ANY PATENT, COPYRIGHT OR OTHER INTELLECTUAL PROPERTY RIGHT.

LIFE SUPPORT POLICY

NATIONAL'S PRODUCTS ARE NOT AUTHORIZED FOR USE AS CRITICAL COMPONENTS IN LIFE SUPPORT DEVICES OR SYSTEMS WITHOUT THE EXPRESS PRIOR WRITTEN APPROVAL OF THE CHIEF EXECUTIVE OFFICER AND GENERAL COUNSEL OF NATIONAL SEMICONDUCTOR CORPORATION. As used herein:

Life support devices or systems are devices which (a) are intended for surgical implant into the body, or (b) support or sustain life and whose failure to perform when properly used in accordance with instructions for use provided in the labeling can be reasonably expected to result in a significant injury to the user. A critical component is any component in a life support device or system whose failure to perform can be reasonably expected to cause the failure of the life support device or system or to affect its safety or effectiveness.

National Semiconductor and the National Semiconductor logo are registered trademarks of National Semiconductor Corporation. All other brand or product names may be trademarks or registered trademarks of their respective holders.

Copyright© 2008 National Semiconductor Corporation

For the most current product information visit us at www.national.com



**National Semiconductor
Americas Technical
Support Center**
Email:
new.feedback@nsc.com
Tel: 1-800-272-9959

**National Semiconductor Europe
Technical Support Center**
Email: europe.support@nsc.com
German Tel: +49 (0) 180 5010 771
English Tel: +44 (0) 870 850 4288

**National Semiconductor Asia
Pacific Technical Support Center**
Email: ap.support@nsc.com

**National Semiconductor Japan
Technical Support Center**
Email: jpn.feedback@nsc.com