

General Description

The MIC863 is a dual low power operational amplifier in SOT23-8 package. It is designed to operate in the 2V to 5V range, rail-to-rail output, with input common-mode to ground. The MIC863 provides 450kHz gain-bandwidth product while consuming only a 4.2µA supply current.

With low supply voltage and SOT23-8 packaging, MIC863 provides two channels as general-purpose amplifiers for portable and battery-powered applications. Its package provides the maximum performance available while maintaining an extremely slim form factor. The minimal power consumption of this IC maximizes the battery life potential.

Features

- SOT23-8 packaging
- 450kHz gain-bandwidth product
- 800kHz, -3dB bandwidth
- 4.2µA supply current/channel
- Rail-to-rail output
- Ground sensing at input (common mode to GND)
- Drives large capacitive loads (0.02µF)
- Unity gain stable

Applications

- Portable equipment
- Medical instrument
- PDAs
- Pagers
- Cordless phones
- Consumer electronics

Ordering Information

Part Number				Ambient Temp. Range	Package
Standard	Marking	Pb-Free	Marking		
MIC863BM8	A35	MIC863YM8	A35	-40°C to +85°C	SOT23-8

Typical Application

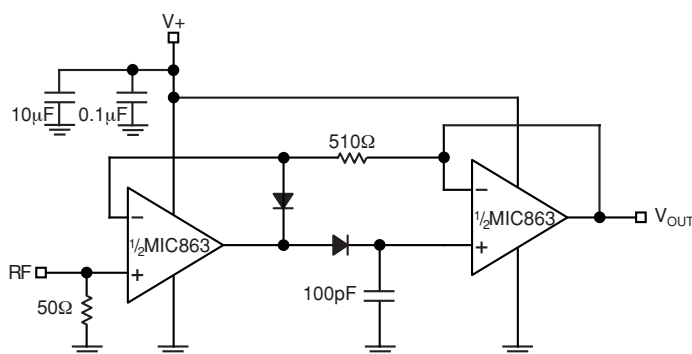

Peak Detector Circuit for AM Radio

Pin Configuration

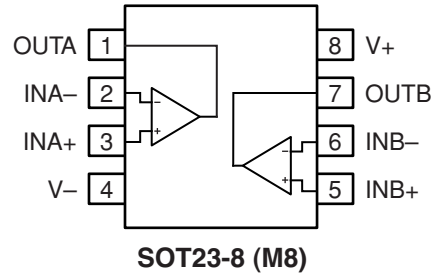

Pin Description

Pin Number	Pin Name	Pin Function
1	OUTA	Output: Amplifier A Output
2	INA-	Amplifier A Inverting (Input)
3	INA+	Amplifier A Non-Inverting (Input)
4	V-	Negative Supply
5	INB+	Amplifier B Non-Inverting (Input)
6	INB-	Amplifier B Inverting (Input)
7	OUTB	Output: Amplifier B Output
8	V+	Positive Supply

Absolute Maximum Ratings (Note 1)

Supply Voltage ($V_{V+} - V_{-}$)	+6.0V
Differential Input Voltage ($ V_{IN+} - V_{IN-} $), Note 4	+6.0V
Input Voltage ($V_{IN+} - V_{IN-}$)	$V_{+} + 0.3V$, $V_{-} - 0.3V$
Lead Temperature (soldering, 5 sec.)	260°C
Output Short Circuit Current Duration	Indefinite
Storage Temperature (T_S)	150°C
ESD Rating, Note 3	

Operating Ratings (Note 2)

Supply Voltage ($V_{+} - V_{-}$)	+2.0V to +5.25V
Ambient Temperature Range	-40°C to +85°C
Package Thermal Resistance	
θ_{JA} (Using 4 layer PCB)	100°C/W
θ_{CA} (Using 4 layer PCB)	70°C/W

Electrical Characteristics

$V_{+} = +2V$, $V_{-} = 0V$, $V_{CM} = V_{+}/2$; $R_L = 500k\Omega$ to $V_{+}/2$; $T_A = 25^{\circ}C$, unless otherwise noted. **Bold** values indicate $-40^{\circ}C \leq T_A \leq +85^{\circ}C$.

Symbol	Parameter	Condition	Min	Typ	Max	Units
V_{OS}	Input Offset Voltage		-6 -5	0.1	6 5	mV
	Differential Offset Voltage			0.5		mV
	Input Offset Voltage Temp Coefficient			6		$\mu V/^{\circ}C$
I_B	Input Bias Current			10		pA
I_{OS}	Input Offset Current			5		pA
V_{CM}	Input Voltage Range	CMRR > 50dB	0.5	1		V
CMRR	Common-Mode Rejection Ratio	$0 < V_{CM} < 1V$	45	75		dB
PSRR	Power Supply Rejection Ratio	Supply voltage change of 2V to 2.7V	50	85		dB
A_{VOL}	Large-Signal Voltage Gain	$R_L = 100k\Omega$, $V_{OUT} 1.4V_{PP}$	66	81		dB
		$R_L = 500k\Omega$, $V_{OUT} 1.4V_{PP}$	73	90		dB
V_{OUT}	Maximum Output Voltage Swing	$R_L = 500k\Omega$	V+3mV	$V_{+} - 1.4mV$		V
V_{OUT}	Minimum Output Voltage Swing	$R_L = 500k\Omega$		$V_{-} + 0.5mV$	V+3mV	V
GBW	Gain-Bandwidth Product	$R_L = 200k\Omega$, $C_L = 2pF$, $A_V = 11$		320		kHz
PM	Phase Margin	$R_L = 200k\Omega$, $C_L = 2pF$, $A_V = 11$		69		$^{\circ}$
BW	-3dB Bandwidth	$A_V = 1$, $C_L = 2pF$, $R_L = 1M\Omega$		600		kHz
SR	Slew Rate	$A_V = 1$, $C_L = 2pF$, $R_L = 1M\Omega$, Positive Slew Rate = 0.17V/ μs		0.33		V/ μs
I_{SC}	Short-Circuit Output Current	Source	1.8	2.6		mA
		Sink	1.5	2.2		mA
I_S	Supply Current (per Op Amp)	No Load		3.5	7	μA
	Channel to Channel Crosstalk	Note 5		-100		dB

$V_{+} = +2.7V$, $V_{-} = 0V$, $V_{CM} = V_{+}/2$; $R_L = 500k\Omega$ to $V_{+}/2$; $T_A = 25^{\circ}C$, unless otherwise noted. **Bold** values indicate $-40^{\circ}C \leq T_A \leq +85^{\circ}C$.

V_{OS}	Input Offset Voltage		-6 -5	0.1	6 5	mV
	Differential Offset Voltage			0.5		mV
	Input Offset Voltage Temp Coefficient			6		$\mu V/^{\circ}C$
I_B	Input Bias Current			10		pA
I_{OS}	Input Offset Current			5		pA
V_{CM}	Input Voltage Range	CMRR > 60dB	1	1.8		V
CMRR	Common-Mode Rejection Ratio	$0 < V_{CM} < 1.35V$	60	83		dB
PSRR	Power Supply Rejection Ratio	Supply voltage change from 2.7V to 3V	55	85		dB
A_{VOL}	Large-Signal Voltage Gain	$R_L = 100k$, $V_{OUT} 2V_{PP}$	70	83		dB
		$R_L = 500k$, $V_{OUT} 2V_{PP}$	78	91		dB

Symbol	Parameter	Condition	Min	Typ	Max	Units
GBW	Gain-Bandwidth Product	$R_L = 200k\Omega$, $C_L = 2pF$, $A_v = 11$		350		kHz
PM	Phase Margin	$R_L = 200k\Omega$, $C_L = 2pF$, $A_v = 11$		65		°
BW	-3dB Bandwidth	$A_v = 1$, $C_L = 2pF$, $R_L = 1M\Omega$		600		kHz
SR	Slew Rate	$A_v = 1$, $C_L = 2pF$, $R_L = 1M\Omega$ Positive Slew Rate = $0.17V/\mu s$		0.35		$V/\mu s$
I_{SC}	Short-Circuit Output Current	Source	4.5	6.3		mA
		Sink	4.5	6.2		mA
I_S	Supply Current (per Op Amp)	No Load		3.6	7	μA
	Channel to Channel Crosstalk	Note 5		-120		dB

$V_{+} = +5V$, $V_{-} = 0V$, $V_{CM} = V_{+}/2$; $R_L = 500k\Omega$ to $V_{+}/2$; $T_A = 25^{\circ}C$, unless otherwise noted. **Bold** values indicate $-40^{\circ}C \leq T_A \leq +85^{\circ}C$.

V_{OS}	Input Offset Voltage		-6 -5	0.1	6 5	mV
	Differential Offset Voltage			0.5		mV
	Input Offset Voltage Temp Coefficient			6		$\mu V/^{\circ}C$
I_B	Input Bias Current			10		pA
I_{OS}	Input Offset Current			5		pA
V_{CM}	Input Voltage Range (from V_{-})	CMRR > 60dB	3.5	4.1		V
CMRR	Common-Mode Rejection Ratio	$0 < V_{CM} < 3.5V$	60	85		dB
PSRR	Power Supply Rejection Ratio	Supply voltage change from 3V to 5V	60	86		dB
A_{VOL}	Large-Signal Voltage Gain	$R_L = 100k\Omega$, $V_{OUT} 4.0V_{PP}$	73	81		dB
		$R_L = 500k\Omega$, $V_{OUT} 4.0V_{PP}$	78	88		dB
V_{OUT}	Maximum Output Voltage Swing	$R_L = 500k\Omega$	$V_{+} - 3mV$	$V_{+} - 1.3mV$		V
V_{OUT}	Minimum Output Voltage Swing	$R_L = 500k\Omega$		$V_{-} + 0.7mV$	$V_{-} + 3mV$	V
GBW	Gain-Bandwidth Product	$R_L = 200k\Omega$, $C_L = 2pF$, $A_v = 11$		450		kHz
PM	Phase Margin			63		°
BW	-3dB Bandwidth	$A_v = 1$, $C_L = 2pF$, $R_L = 1M\Omega$		800		kHz
SR	Slew Rate	$A_v = 1$, $C_L = 2pF$, $R_L = 1M\Omega$ Positive Slew Rate = $0.2V/\mu s$		0.35		$V/\mu s$
I_{SC}	Short-Circuit Output Current	Source	17	23		mA
		Sink	18	27		mA
I_S	Supply Current (per Op Amp)	No Load		4.2	8	μA
	Channel to Channel Crosstalk	Note 5		-120		dB

Note 1. Exceeding the absolute maximum rating may damage the device.

Note 2. The device is not guaranteed to function outside its operating rating.

Note 3. Devices are ESD sensitive. Handling precautions recommended. Human body model, 1.5k in series with 100pF. Pin 4 is ESD sensitive

Note 4. Exceeding the maximum differential input voltage will damage the input stage and degrade performance (in particular, input bias current is likely to increase).

Note 5. DC signal referenced to input. Refer to Typical Characteristics graphs for AC performance.

DC Performance Characteristics

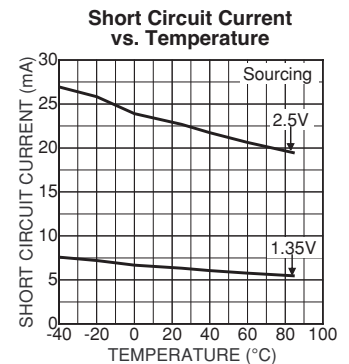
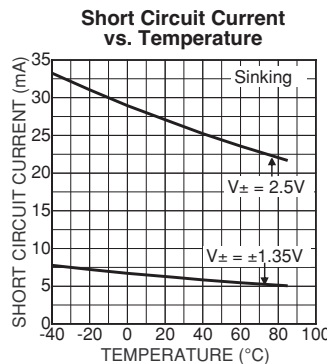
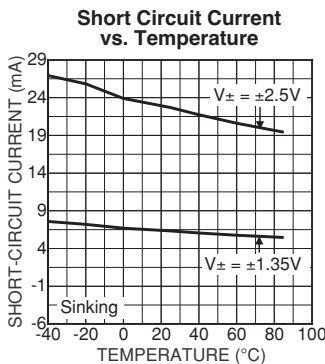
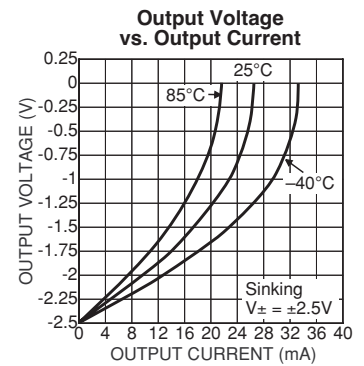
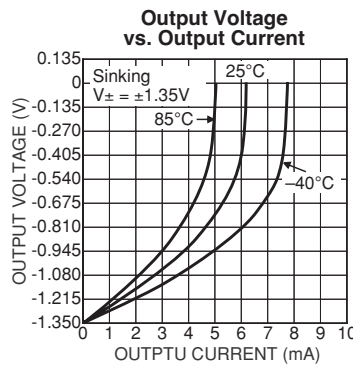
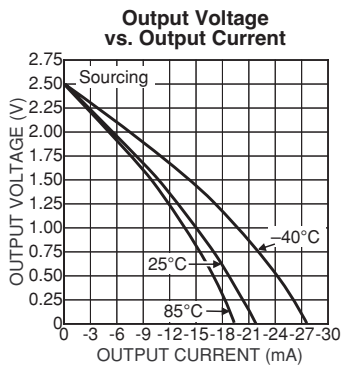
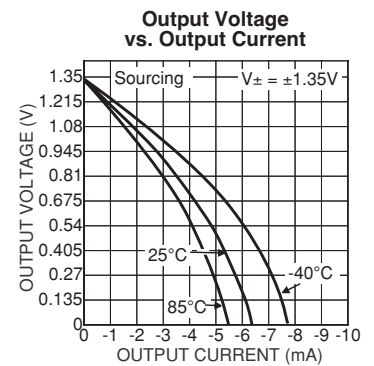
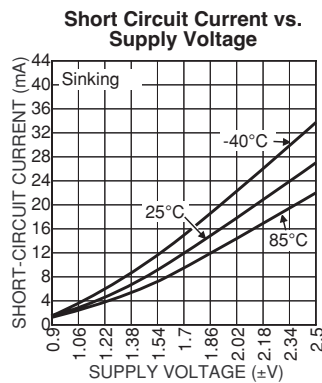
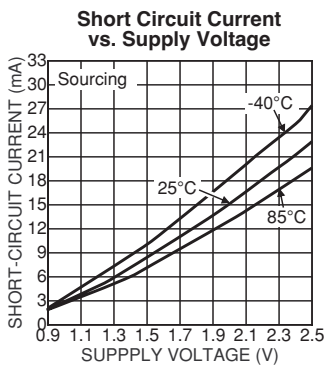
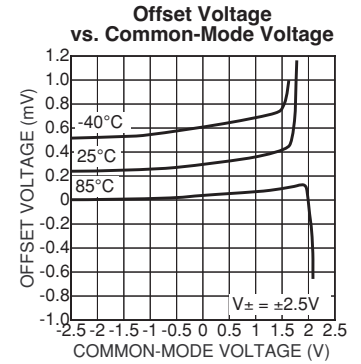
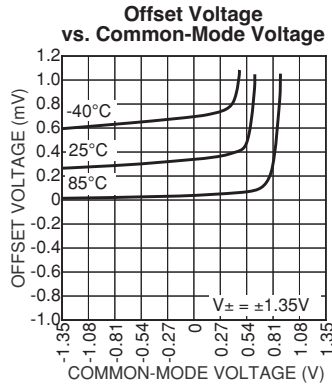
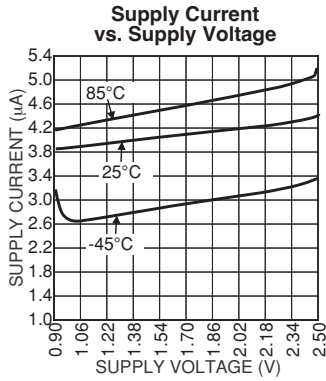

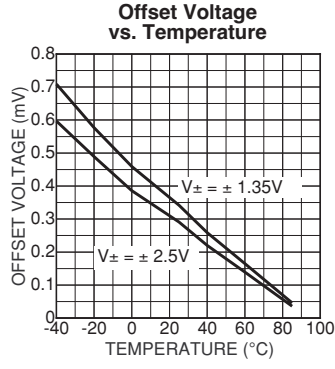
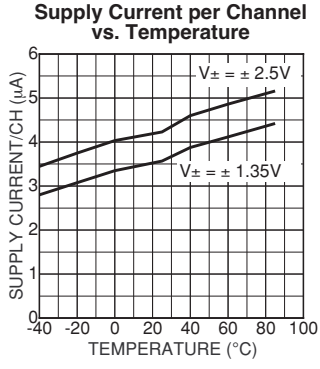

AC Performance Characteristics

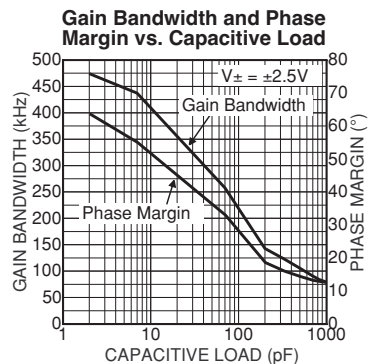
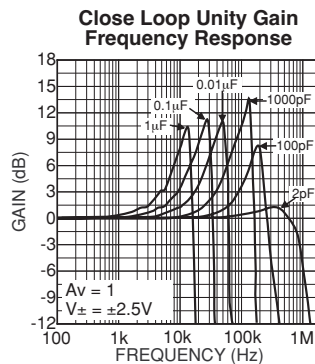
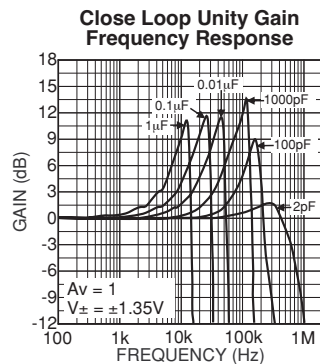
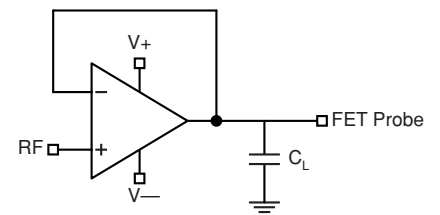
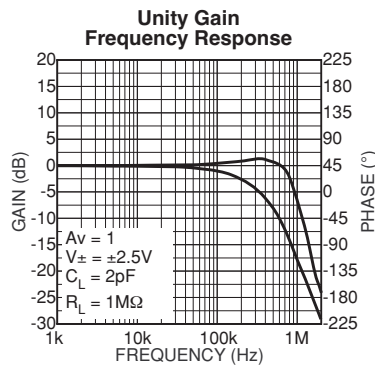
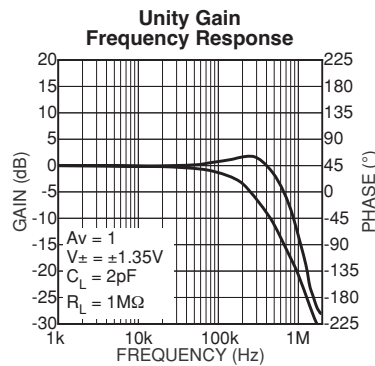
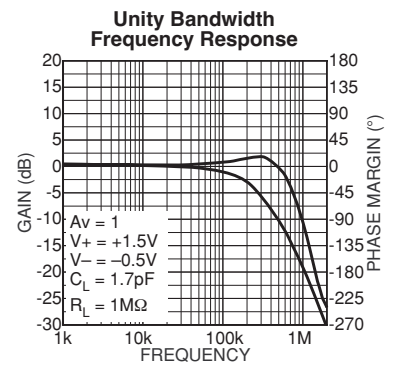
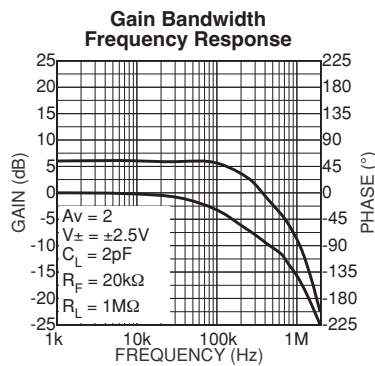
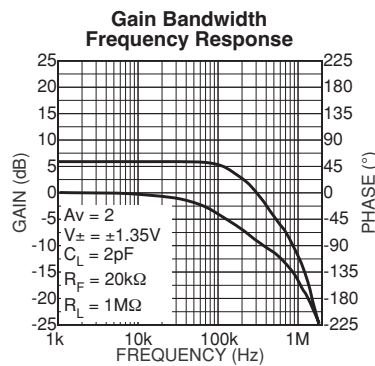
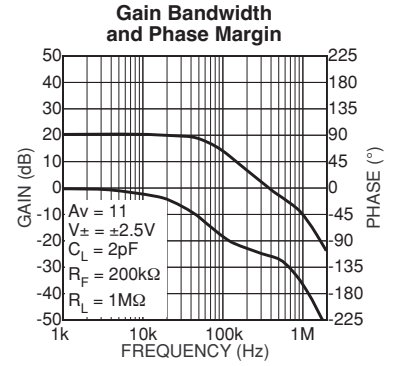
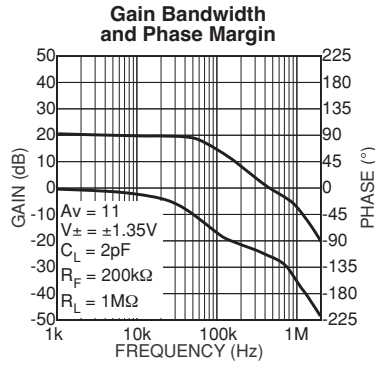
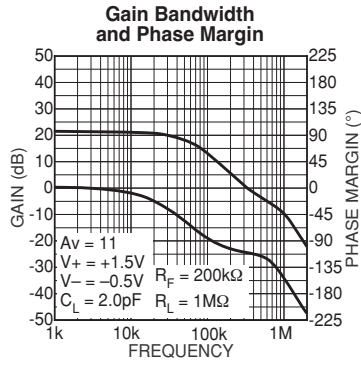

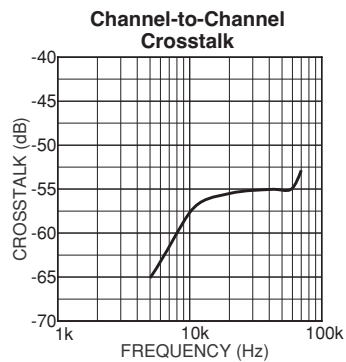
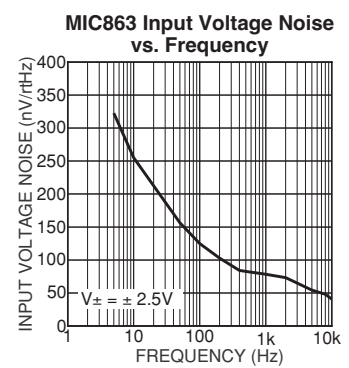
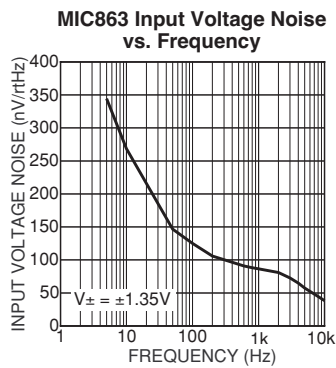
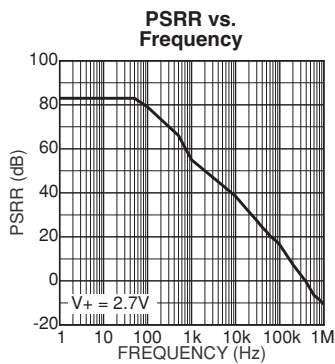
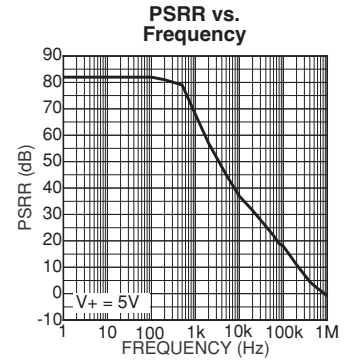
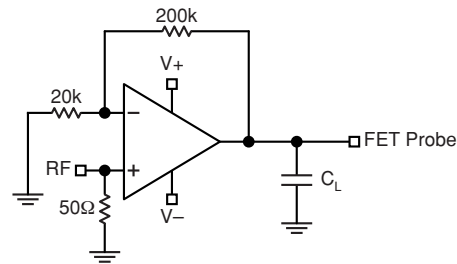
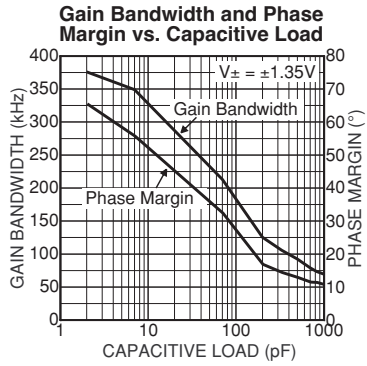

Functional Characteristics

Small Signal Pulse Response
Test Circuit 3: $A_V = 1$

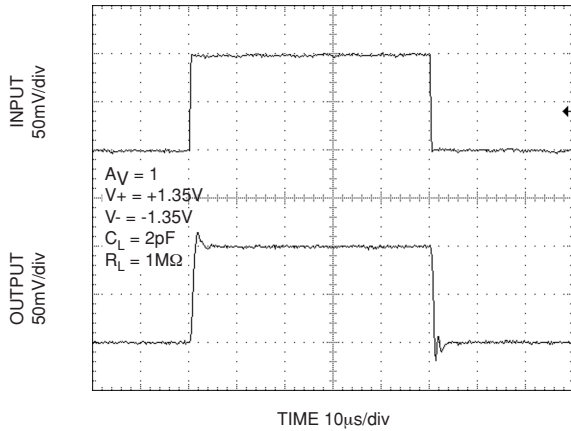

Small Signal Pulse Response
Test Circuit 3: $A_V = 1$

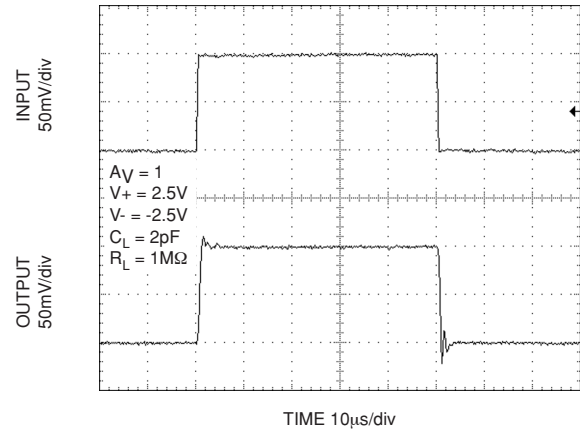

Small Signal Pulse Response
Test Circuit 3: $A_V = 1$

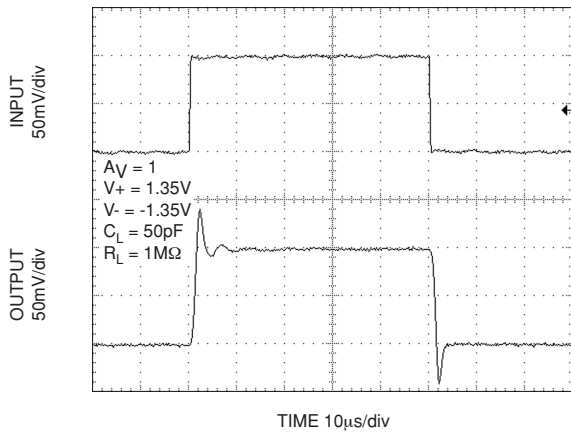

Small Signal Pulse Response
Test Circuit 3: $A_V = 1$

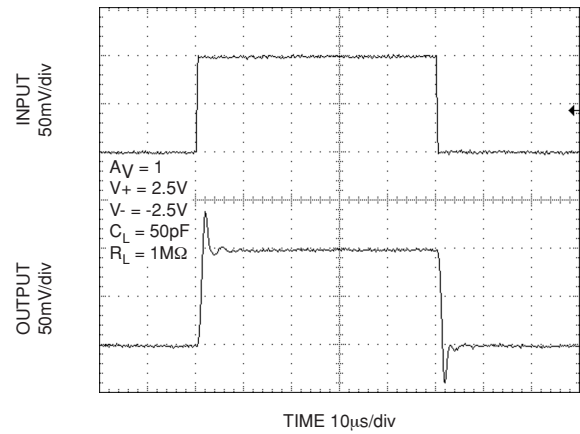

Small Signal Pulse Response
Test Circuit 3: $A_V = 1$

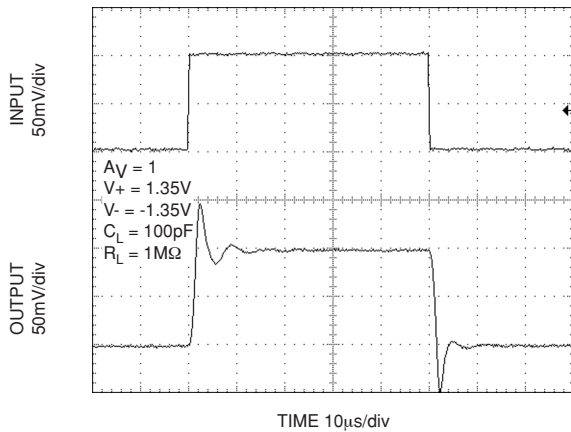

Small Signal Pulse Response
Test Circuit 3: $A_V = 1$

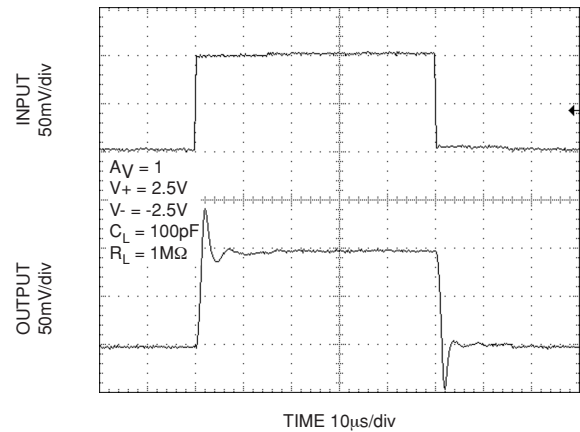

Small Signal Pulse Response
Test Circuit 3: $A_V = 1$

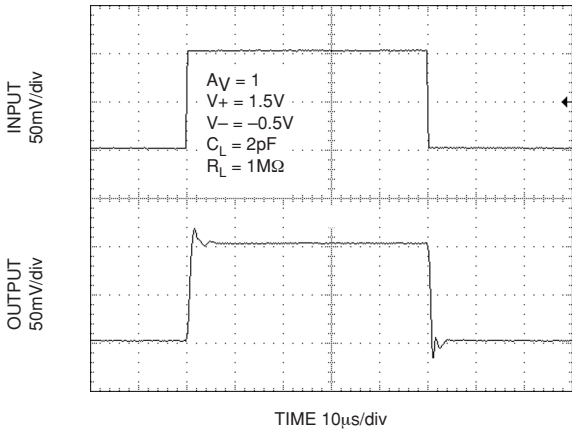

Small Signal Pulse Response
Test Circuit 4: $A_V = -1$

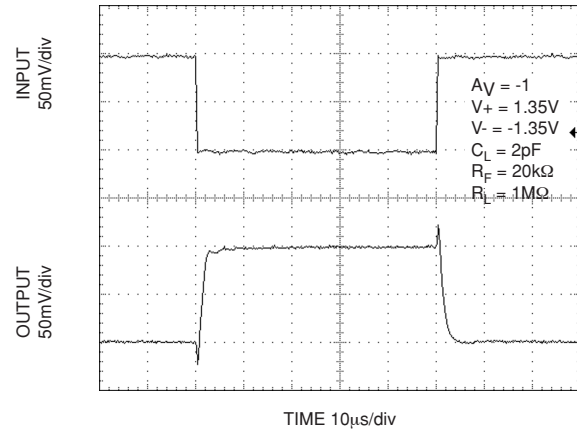

Small Signal Pulse Response
Test Circuit 4: $A_V = -1$

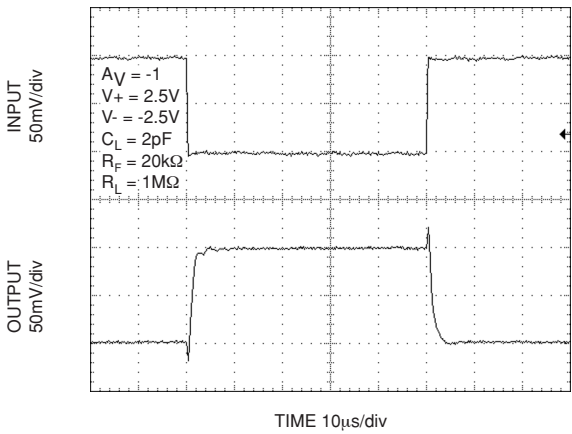

Small Signal Pulse Response
Test Circuit 4: $A_V = -1$

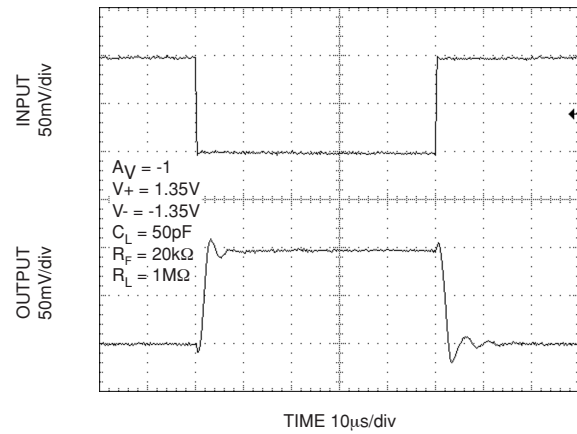

Small Signal Pulse Response
Test Circuit 4: $A_V = -1$

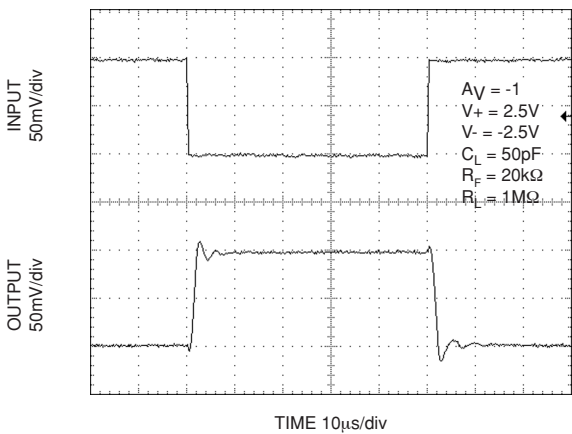

Large Signal Pulse Response
Test Circuit 3: $A_V = 1$

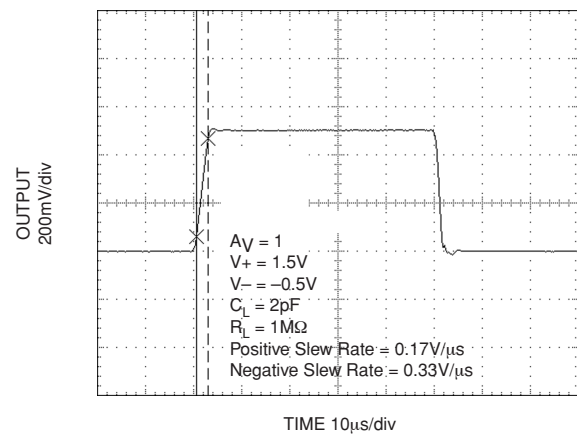

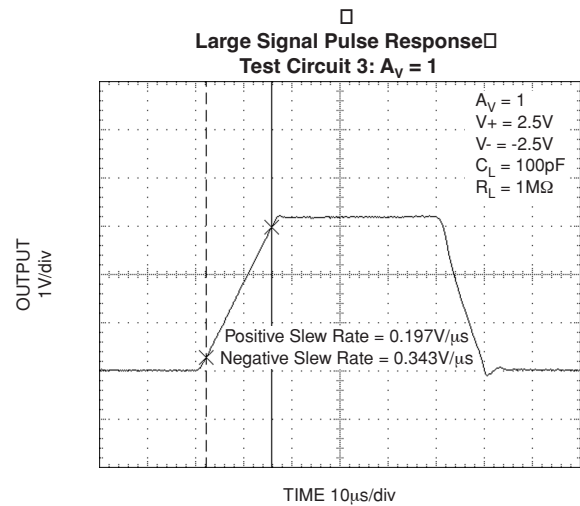
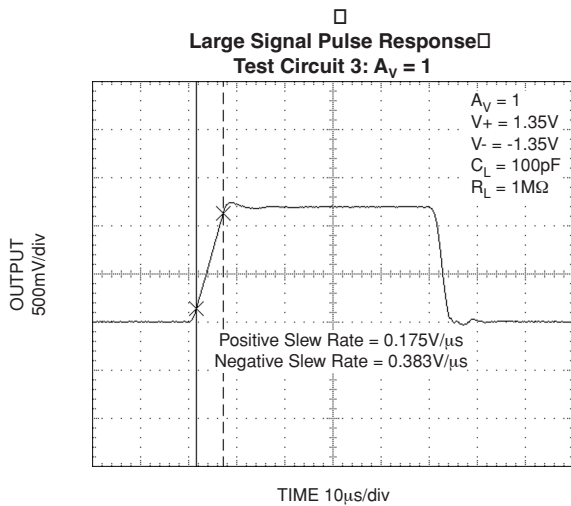
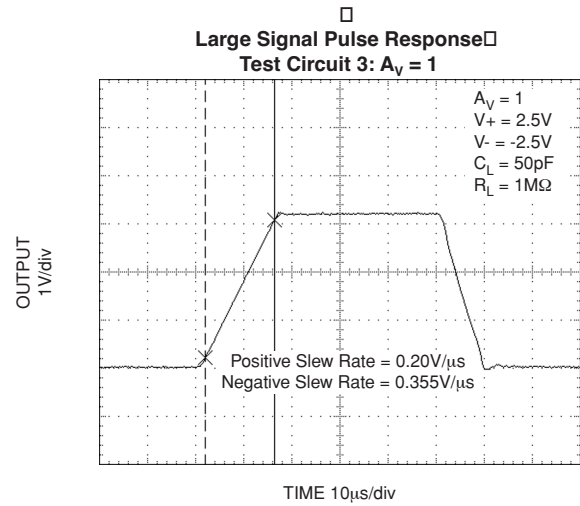
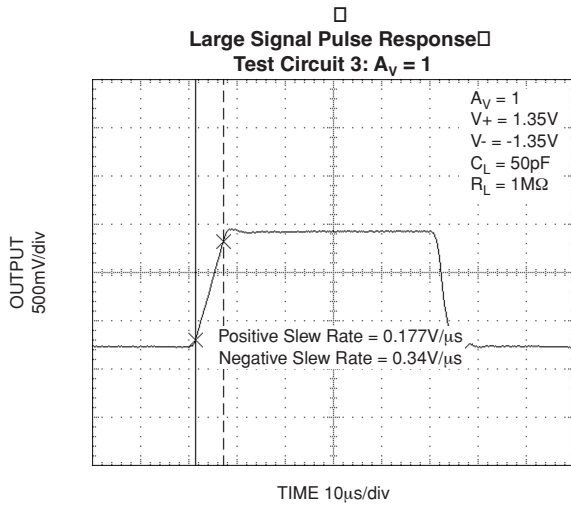
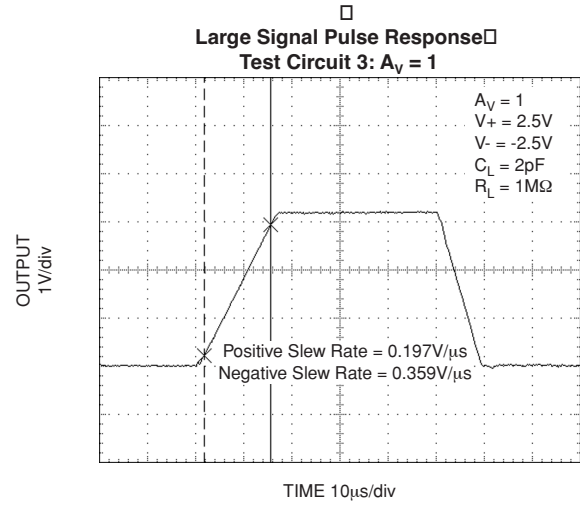
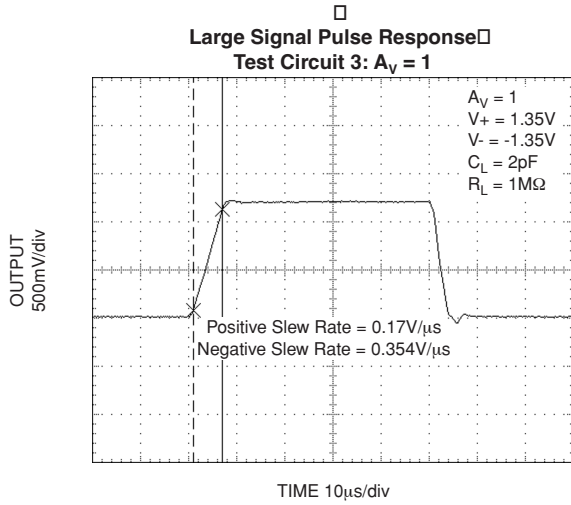

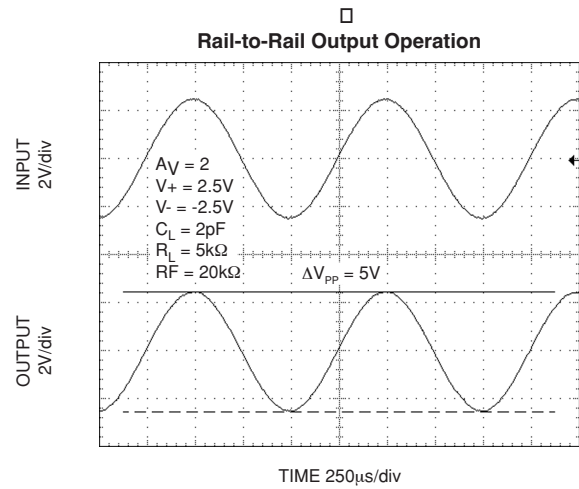
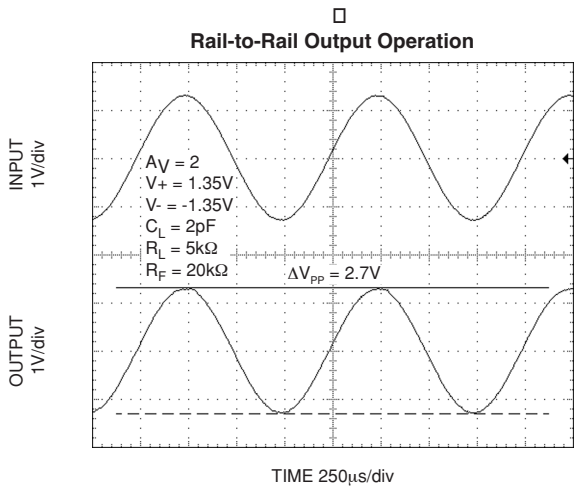
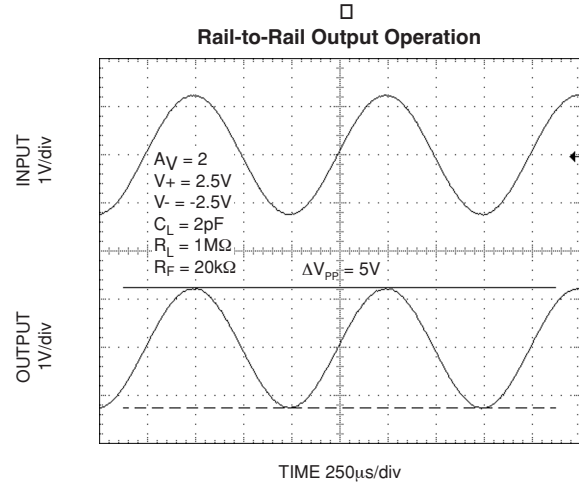
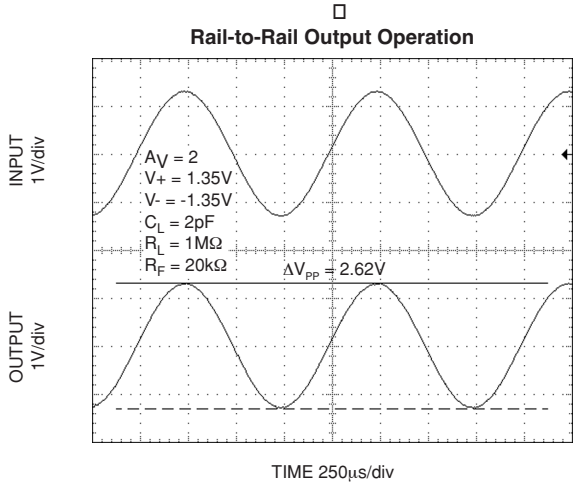

Applications Information

Power Supply Bypassing

Regular supply bypassing techniques are recommended. A 10 μ F capacitor in parallel with a 0.1 μ F capacitor on both the positive and negative supplies are ideal. For best performance all bypassing capacitors should be located as close to the op amp as possible and all capacitors should be low ESL (equivalent series inductance), ESR (equivalent series resistance). Surface-mount ceramic capacitors are ideal.

Supply and Loading Resistive Considerations

The MIC863 is intended for single supply applications configured with a grounded load. It is not advisable to operate the MIC863 under either of the following conditions when the load is less than 20k Ω and the output swing is greater than 1V(peak-to-peak):

- 1). A grounded load and split supplies ($\pm V$) or
- 2). A single supply where the load is terminated above ground.

Under the above conditions, there may be some instability when the output is sinking current.

Package Information

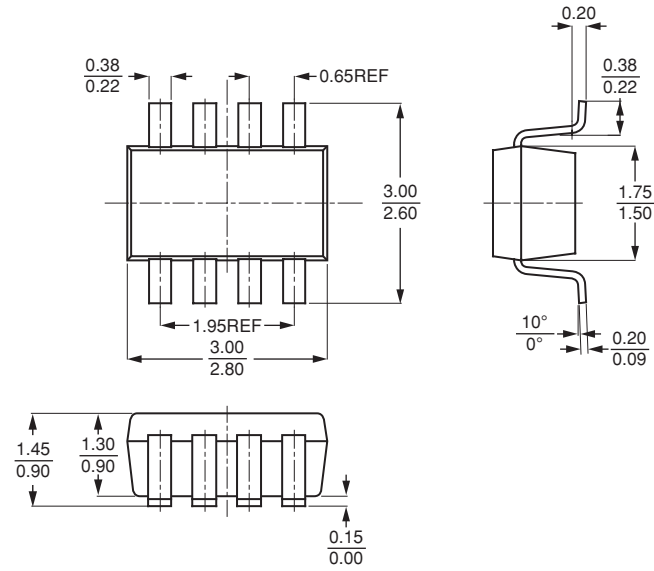

SOT23-8 (M8)

MICREL, INC. 1849 FORTUNE DRIVE SAN JOSE, CA 95131 USA

TEL + 1 (408) 944-0800 FAX + 1 (408) 944-0970 WEB <http://www.micrel.com>

This information is believed to be accurate and reliable, however no responsibility is assumed by Micrel for its use nor for any infringement of patents or other rights of third parties resulting from its use. No license is granted by implication or otherwise under any patent or patent right of Micrel, Inc.

© 2005 Micrel, Incorporated