

SINGLE SUPPLY DUAL AMPLIFIER

■ GENERAL DESCRIPTION

The **NJM12904** is single-supply dual operational amplifier, which can operate from 2V supply. The features are low offset voltage, low bias current, and drive TTL or DTL circuit directly. The package lineup is DIP, SIP, DMP and others compact so that the **NJM12904** is suitable for audio for low voltage operation and any other kind of signal amplifier.

■ FEATURES

- Operating Voltage (+2V to +14V)
- Input Offset Voltage (5mV max.)
- Slew Rate (0.7V/μs typ.)
- Operating Current (0.7mA typ.)
- Bipolar Technology
- Package Outline

NJM12904D : DIP8
 NJM12904E : EMP8
 NJM12904R : VSP8
 NJM12904L : SIP8

NJM12904M : DMP8
 NJM12904V : SSOP8
 NJM12904RB1 : TVSP8

■ PACKAGE OUTLINE



NJM12904D



NJM12904M



NJM12904E



NJM12904V



NJM12904R



NJM12904RB1

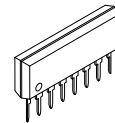

NJM12904L

■ PIN CONFIGURATION

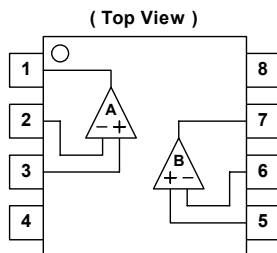

NJM12904D, NJM12904M
 NJM12904E, NJM12904V
 NJM12904R, NJM12904RB1

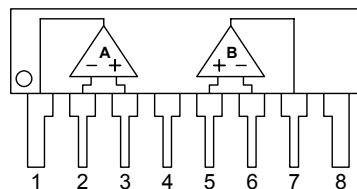

NJM12904L

PIN FUNCTION

1. A OUTPUT
2. A -INPUT
3. A +INPUT
4. GND
5. B +INPUT
6. B -INPUT
7. B OUTPUT
8. V⁺

■ EQUIVALENT CIRCUIT (1/2Shown)

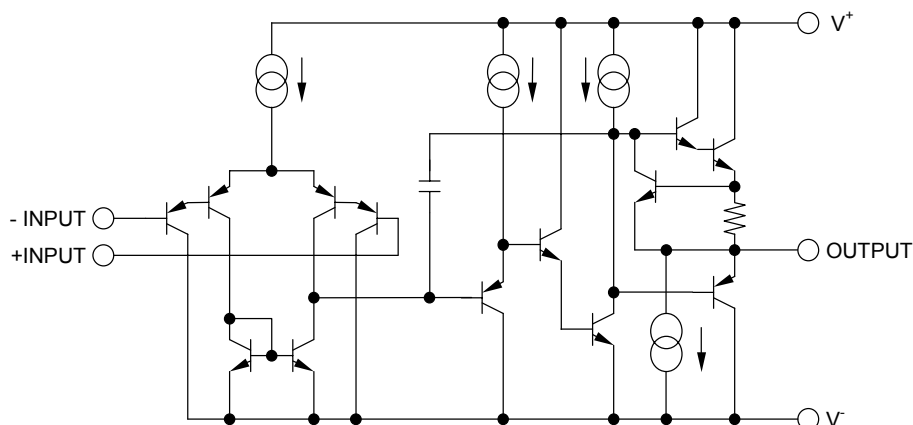

■ ABSOLUTE MAXIMUM RATING

(Ta=25°C)

PARAMETER	SYMBOL	RATINGS	UNIT
Supply Voltage	V^+	15	V
Differential Input Voltage	V_{ID}	14	V
Input Voltage	V_{IC}	- 0.3 to +14	V
Power Dissipation	P_D	(DIP8) 500 (DMP8) 300 (EMP8) 300 (SSOP8) 250 (VSP8) 320 (TVSP8) 320 (SIP8) 800	mW
Operating Temperature Range	Topr	- 40 to +85	°C
Storage Temperature Range	Tstg	- 50 to +125	°C

■ ELECTRICAL CHARACTERISTICS ($V^+=5V$, Ta=25°C)

PARAMETER	SYMBOL	TEST CONDITION	MIN.	TYP.	MAX.	UNIT
Operating Voltage	Vopr		2	-	14	V
Input Offset Voltage	V_{IO}	$R_S=0\Omega$	-	1	5	mV
Input Offset Current	I_{IO}		-	5	50	nA
Input Bias Current	I_B		-	20	150	nA
Large Signal Voltage Swing	A_V	$R_L \geq 2k\Omega$	-	100	-	dB
Maximum Output Voltage Range	V_{OM}	$R_L=2k\Omega$	3.5	-	-	V
Input Common Mode Voltage Range	V_{ICM}		0 to 3.5	-	-	V
Common Mode Rejection Ratio	CMR		-	85	-	dB
Supply Voltage Rejection Ratio	SVR		-	100	-	dB
Output Source Current	I_{SOURCE}	$V_{IN}^+=1V, V_{IN}^-=0V$	20	40	-	mA
Output Sink Current	I_{SINK}	$V_{IN}^+=0V, V_{IN}^-=1V$	8	20	-	mA
Channel Separation	CS	f=1k to 20kHz	-	120	-	dB
Operating Current	I_{CC}	$R_L=\infty$	-	0.7	1.2	mA
Slew Rate	SR		-	0.7	-	V/ μ s
Gain Bandwidth Product	GB		-	1.5	-	MHz

■ TYPICAL CHARACTERISTICS

Operating Current vs. Supply Voltage
($T_a=25^\circ\text{C}$)

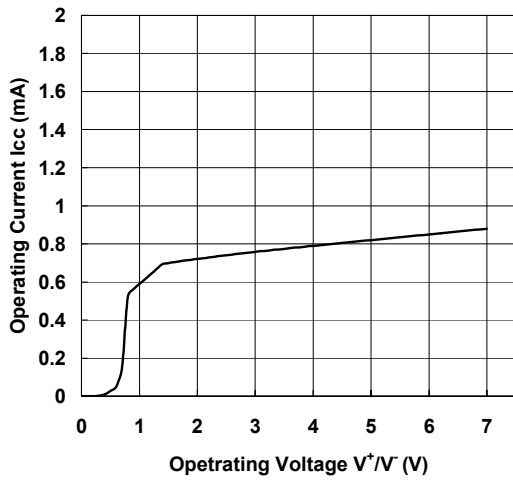

Input Offset Voltage vs. Operating Voltage
($T_a=25^\circ\text{C}$)

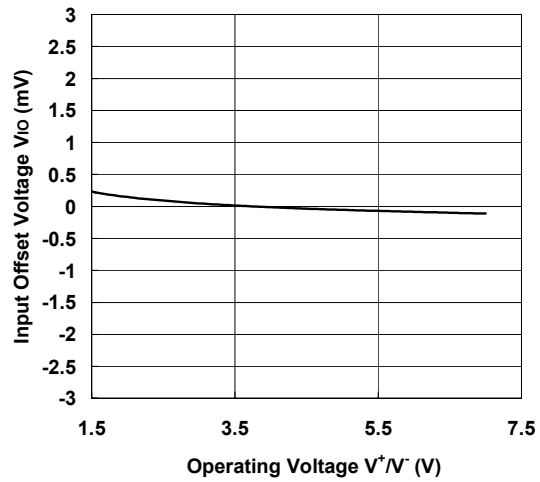

Input Bias Current vs. Operating Voltage
($T_a=25^\circ\text{C}$)

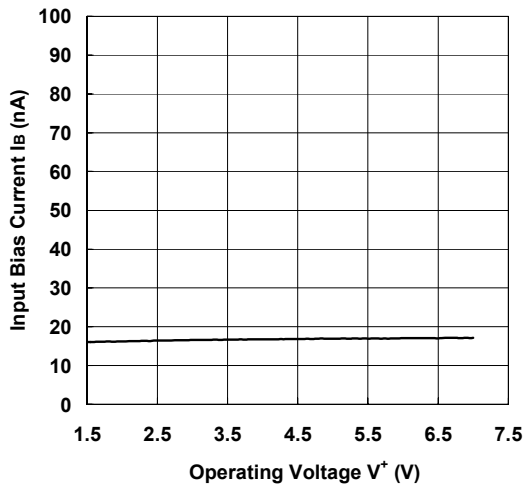

Maximum Output Voltage Swing
($T_a=25^\circ\text{C}$)

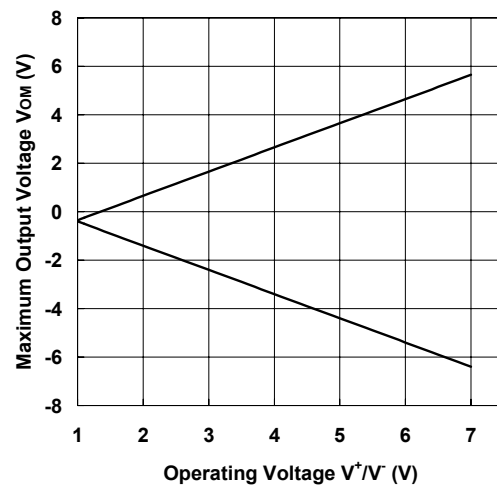

Input Offset Voltage vs. Input Voltage
($V^+=5\text{V}$, $T_a=25^\circ\text{C}$)

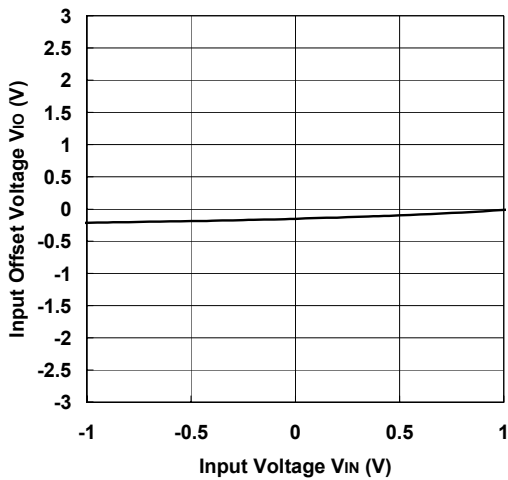

■ TYPICAL CHARACTERISTICS

Maximum Output Voltage vs. Load Resistance (Ta=25°C)

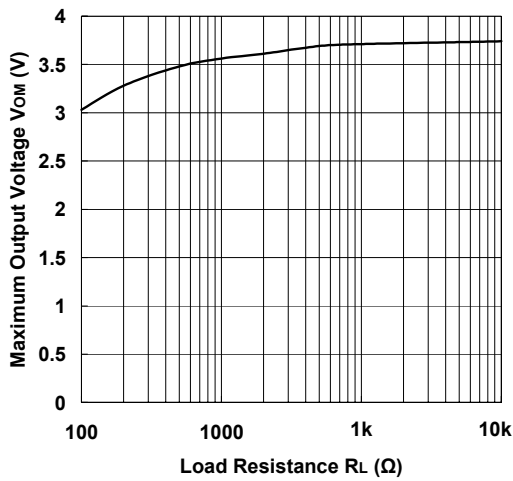

Maximum Output Voltage vs. Frequency (Ta=25°C)

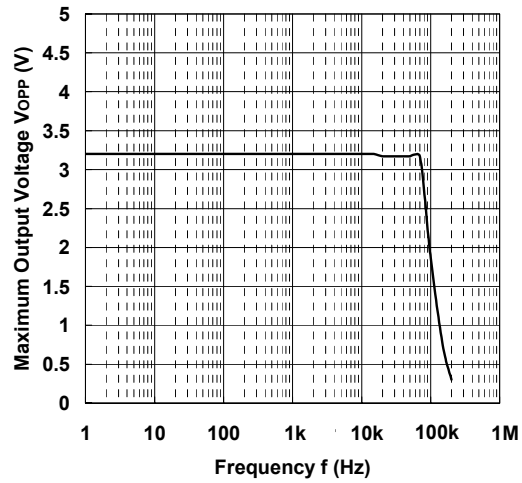

Output Voltage vs. Output Sink Current (Ta=25°C)

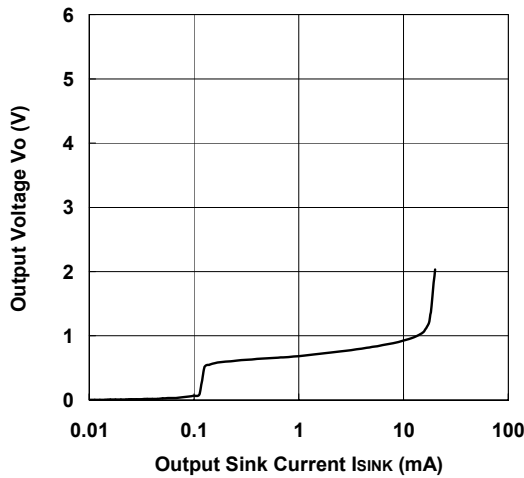

Output Voltage vs. Output Source Current (Ta=25°C)

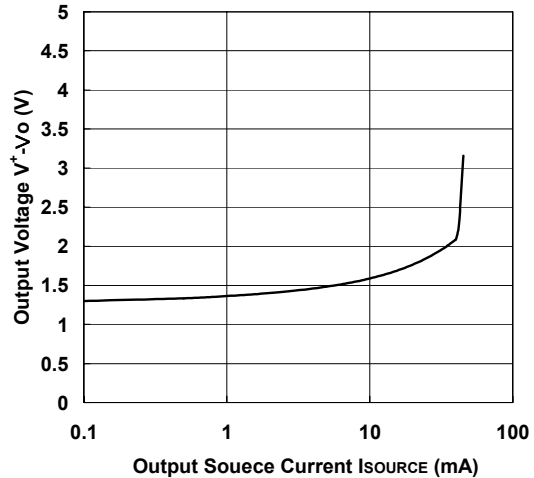

Voltage Gain vs. Operating Voltage (Ta=25°C, R_L=2kΩ)

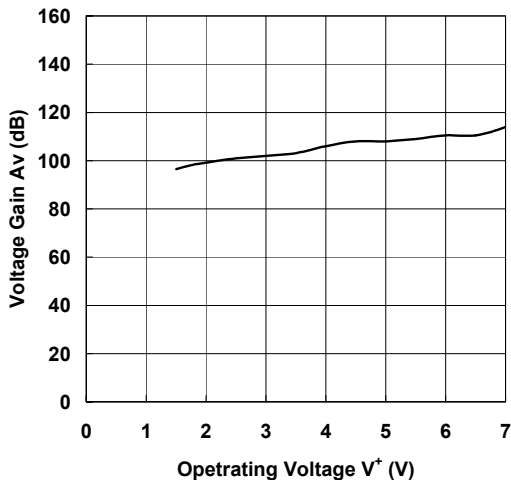

Voltage Gain/Phase vs. Frequency (Ta=25°C)

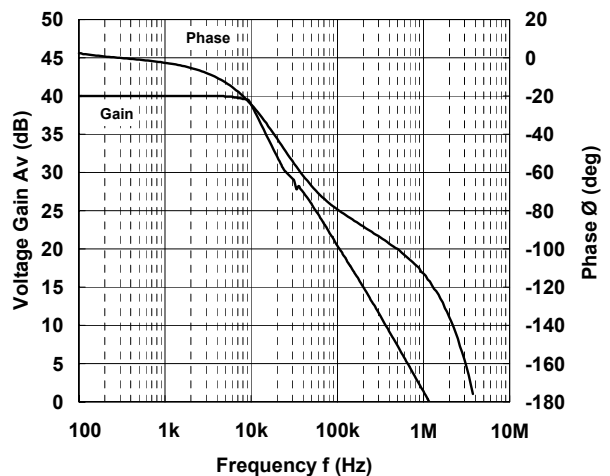

■ TYPICAL CHARACTERISTICS

Slew Rate (Rise)

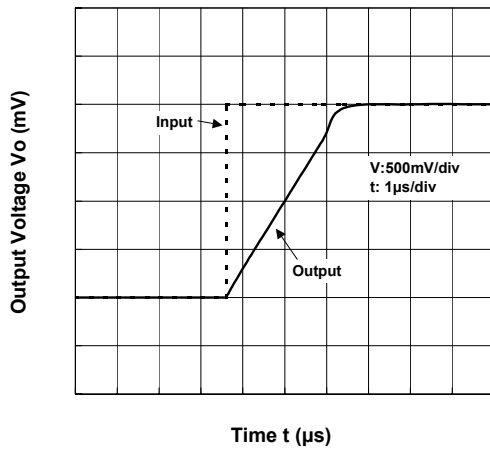

Slew Rate (Fall)

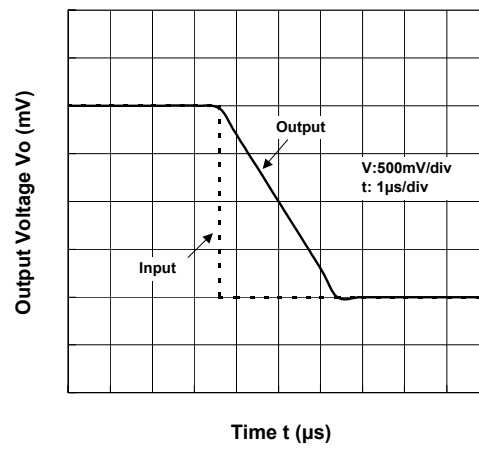

Operating Current vs. Ambient Temp.

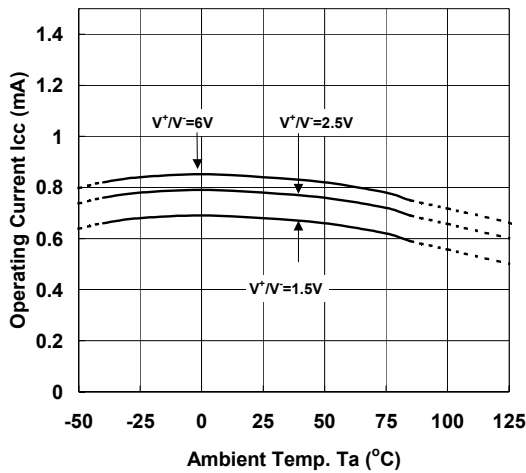

Input Offset Voltage vs. Ambient Temp.

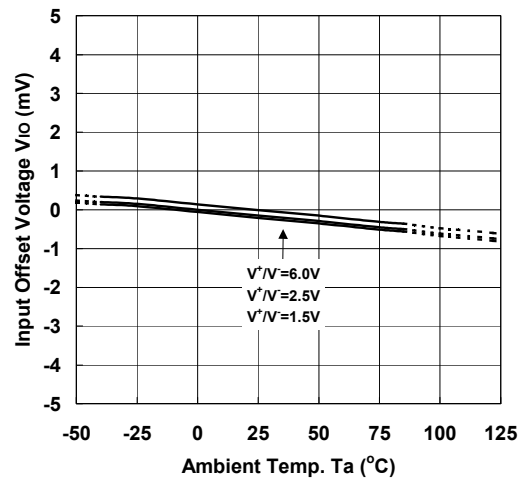

Input Bias Current vs. Ambient Temp.

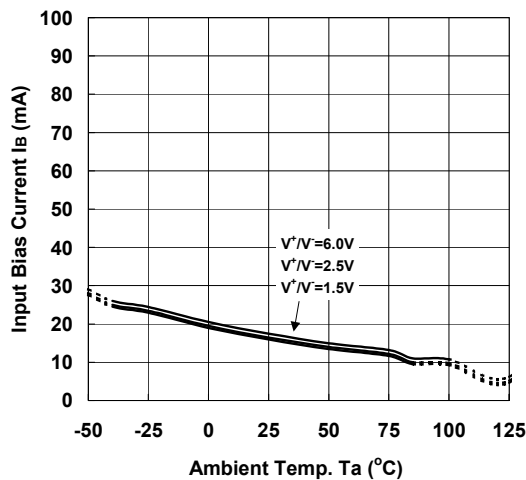

Maximum Output Voltage vs. Ambient Temp.

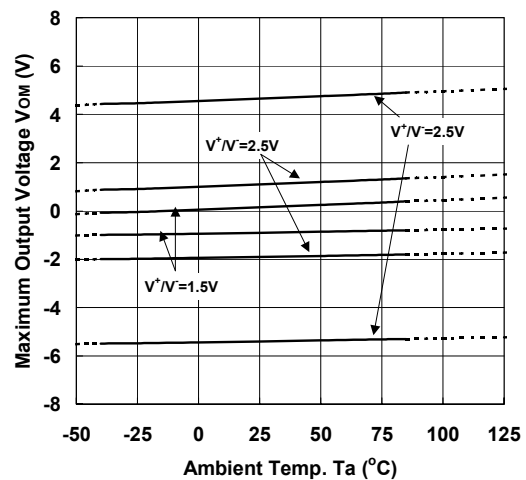

■ TYPICAL CHARACTERISTICS

Output Sink Current vs. Ambient Temp.

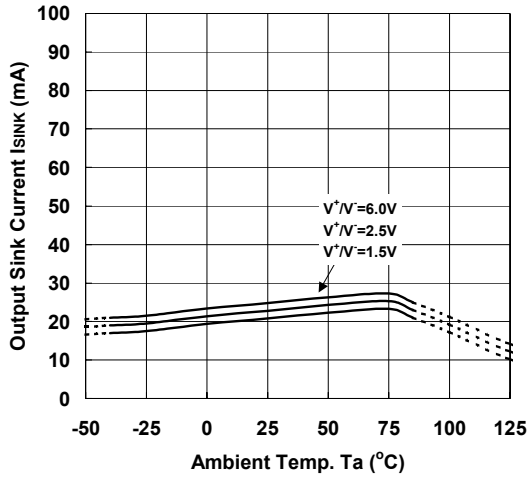

Output Source Current vs. Ambient Temp.

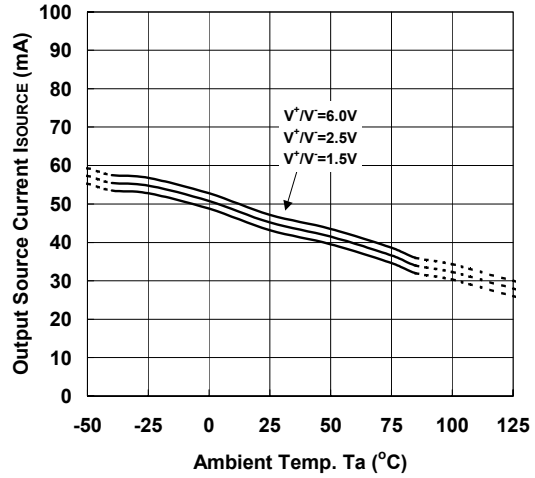

Voltage Gain vs. Ambient Temp.

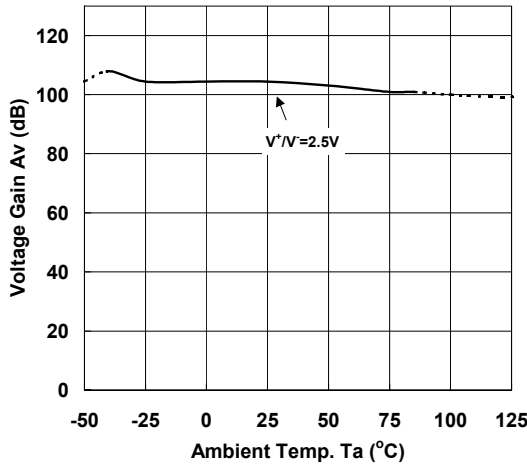

Common Mode Rejection Ratio vs. Ambient Temp.

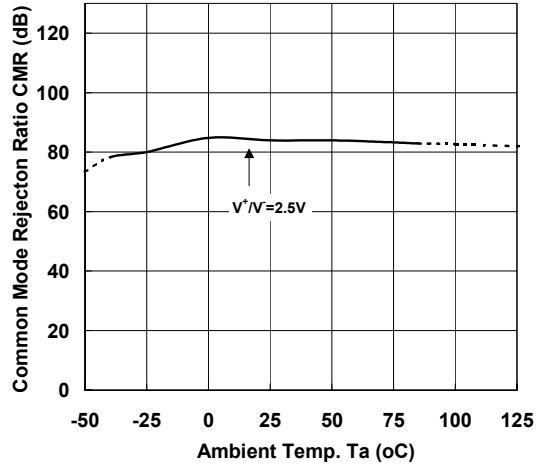

Supply Voltage Rejection Ratio vs. Ambient Temp.

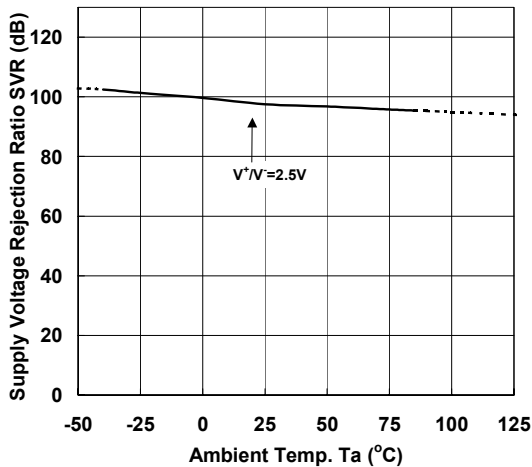

[CAUTION]

The specifications on this databook are only given for information, without any guarantee as regards either mistakes or omissions. The application circuits in this databook are described only to show representative usages of the product and not intended for the guarantee or permission of any right including the industrial rights.