

Mute detector IC for 3V sets

BA3708F

The BA3708F is a mute detector IC for 3V tape players. When the signal is higher than the input decision level V_{IN} and longer than the song detect time, a pulse of width T_w is output after the pulse delay time T_D which begins when the input signal ends. The output is an open collector which enables direct drive of the plunger. A mute function is included which makes it possible to stop detection.

●Applications

3V tape players

●Features

- 1) Low supply voltage (can be operated at 1.8V; recommended operating voltage is 2.0 to 5.0V).
- 2) Uses the song detection method to minimize incorrect detection caused by noise between songs.
- 3) The pulse delay time T_D , pulse width T_w , and song detect time T_C can be set using external CR time constants.
- 4) Includes a mute circuit which makes it possible to stop song selection.
- 5) Built-in output transistor enables direct drive of the plunger. ($I_{O\ Max.} = 100\text{mA}$)

●Absolute maximum ratings ($T_a = 25^\circ\text{C}$)

Parameter	Symbol	Limits	Unit
Power supply voltage	V_{CC}	6.0	V
Power dissipation	P_d	550*1	mW
Operating temperature	T_{opr}	-25~+75	°C
Storage temperature	T_{stg}	-55~+125	°C
Maximum output current	$I_{O\ Max.}$	100*2	mA

*1 Reduced by 5.5mW for each increase in T_a of 1°C over 25°C.

*2 $T_w=200\text{ms}$ on duty cycle=30%

●Recommended operating conditions

Parameter	Symbol	Min.	Typ.	Max.	Unit
Power supply voltage	V_{CC}	1.8	3.0	5.0	V

● Block diagram

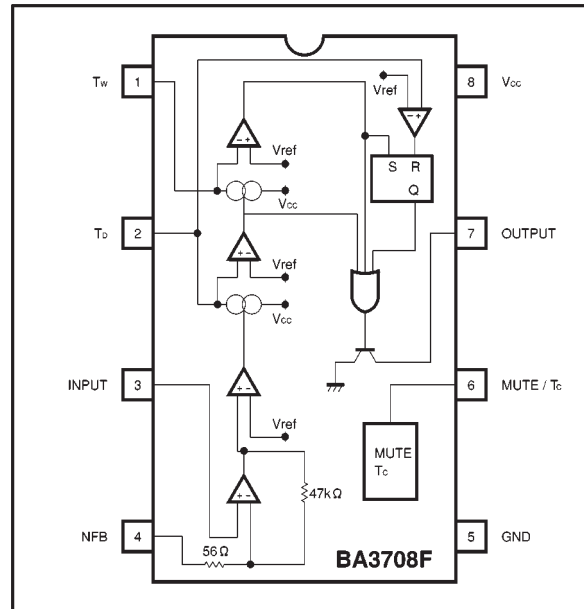

● Electrical characteristics (unless otherwise noted, Ta = 25°C and Vcc = 3V)

Parameter	Symbol	Min.	Typ.	Max.	Unit	Conditions
Quiescent current	I _Q	3.5	7	10.5	mA	MUTE OFF
Input discrimination level	V _{IN}	-67	-64	-61	dBV	f=10kHz, C _{NF} =0.47 μF
Mute detect timing	T _D	44	63	82	ms	R _D =390kΩ, C _D =0.1 μF
Output pulse width	T _W	42	60	78	ms	R _W =390kΩ, C _D =0.1 μF
Song detection time	T _C	150	250	350	ms	C _C =2.2 μF
Output saturation voltage	V _{OL}	—	0.25	0.5	V	I _{OUT} =50mA
Pin 6 threshold voltage 1	V _{6TH-1}	15	45	85	mV	MUTE OFF→MUTE ON
Pin 6 threshold voltage 2	V _{6TH-2}	—	1.5	—	V	During song detection

● Measurement circuit

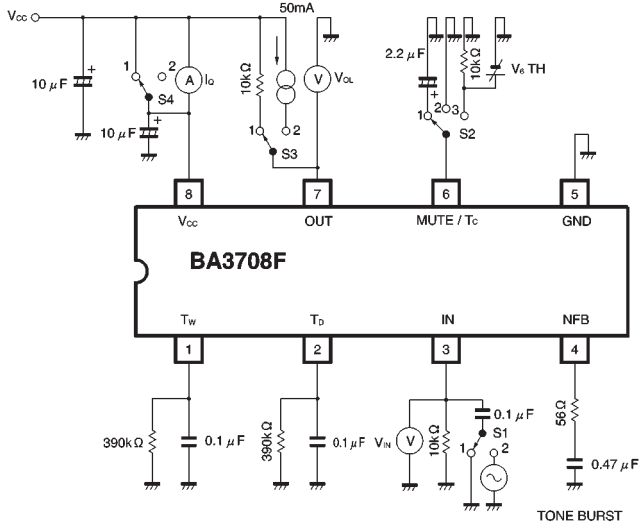

Fig. 1

Switch operations

	S ₁	S ₂	S ₃	S ₄
I _Q	1	1	1	2
V _{IN}	2	1	1	1
T _D	2	1	1	1
T _W	2	1	1	1
T _C	2	1	1	1
V _{OL}	1	1	2	1
V _{6 TH}	1	3	1	1

● Application example

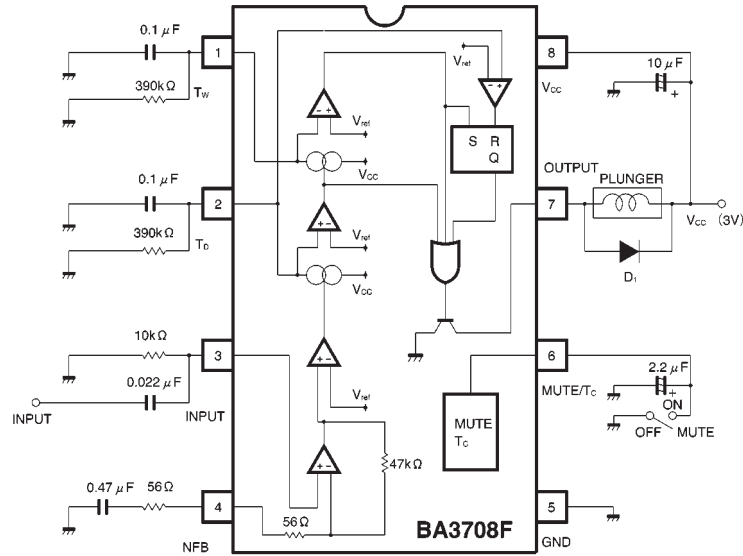

Fig. 2

●Circuit operation

(1) Input amplifier

The input amplifier is a PNP differential amplifier, and the input pin (Pin 3) must be directly connected to ground through a 10kΩ or less bias resistor (R_{IN}). If R_{IN} is too large, an input offset may occur and operation will become unstable. The gain and frequency characteristics of the amplifier are determined by C_{IN} and R_{IN} connected to the input pin (Pin 3), and C_{NF} and R_{NF} connected to the NF_B pin (Pin 4). (Figure 3)

(2) Timing

An output pulse of width T_w is generated from the output pin (Pin 7) after the pulse delay time T_D which begins when the input signal ends. The values of T_D and T_w are determined by the RC time constants of Pin 2 and Pin 1.

$$T_D (\text{ms}) \approx 1.7 \times C_D (\mu\text{F}) \times R_D (\text{k}\Omega)$$

$$T_w (\text{ms}) \approx 1.6 \times C_w (\mu\text{F}) \times R_w (\text{k}\Omega)$$

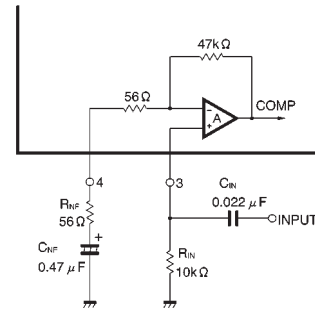

Fig. 3

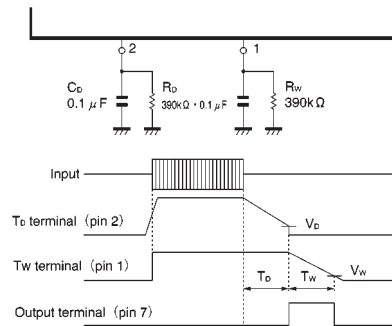

Fig. 4

(3) Song detect time T_C and mute circuit

To prevent incorrect detection due to noise between songs, a song detect function has been included. With this function, the plunger activate pulse is only output when the input signal is longer than the song detect time T_C , and therefore a song. A pulse is not output for noise signals shorter than T_C . The length of T_C is set by the value of the capacitor C_C connected to Pin 6. (See Fig. 18 for the relation between C_C and T_C .)

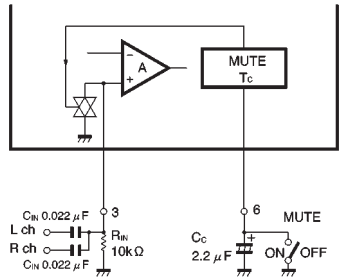

Fig. 5

If Pin 6 is connected to ground, the mute circuit will operate and song detection will stop. In this case, the value of the input resistor connected to Pin 3 will be smaller (approximately 1kΩ), and this will prevent the increase of crosstalk between the left and right channels.

(4) Output circuit

The output circuit is an open collector which is suitable for mechanical systems where the plunger is on during song selection. The pulse width T_W is 200 ms and the duty cycle is 30%, and drive is possible up to an output current $I_{OUT} = 100mA$. The output is OFF (high) while the mute function operates. A discharge diode must be added in parallel with the plunger solenoid.

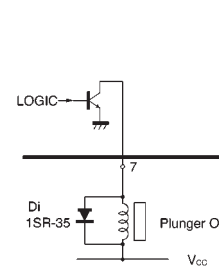

Fig. 6

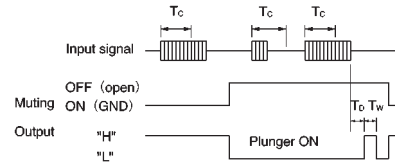

Fig. 7

●Electrical characteristic curves

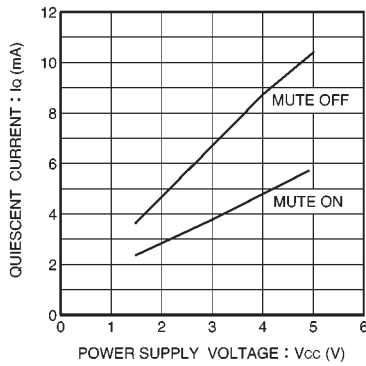

Fig. 8 Quiescent current vs. power supply voltage

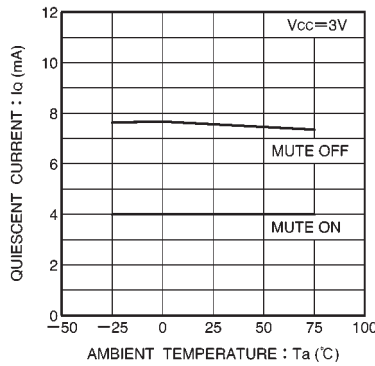

Fig. 9 Quiescent current vs. ambient temperature

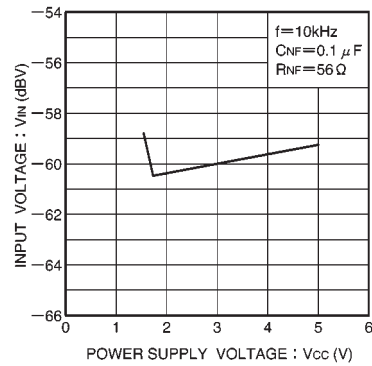

Fig.10 Input discrimination level vs. power supply voltage

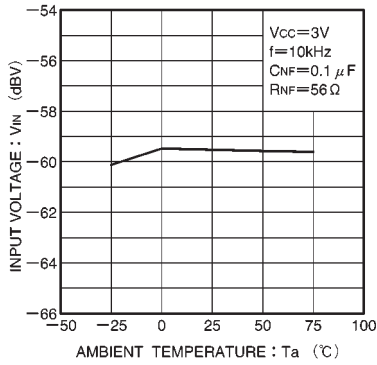

Fig.11 Input discrimination level vs. ambient temperature

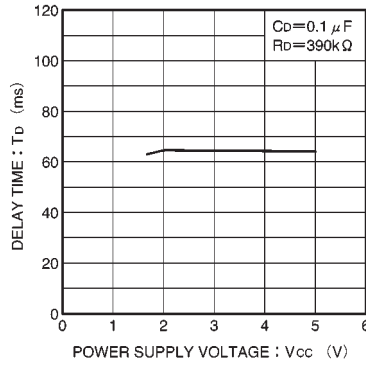

Fig. 12 Mute detection time vs. power supply voltage

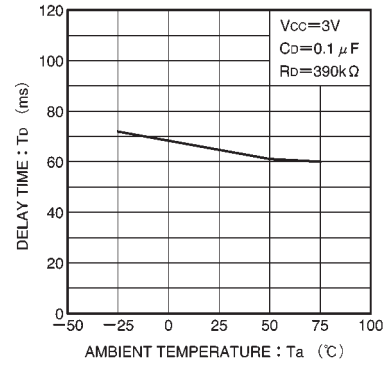

Fig. 13 Mute detection time vs. ambient temperature

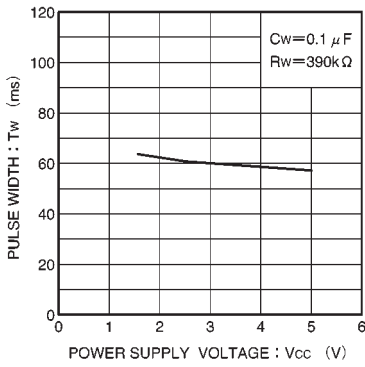

Fig. 14 Output pulse width vs. power supply voltage

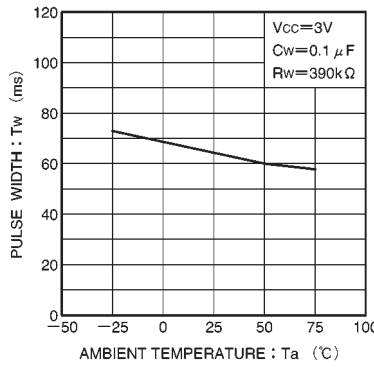

Fig. 15 Output pulse width vs. ambient temperature

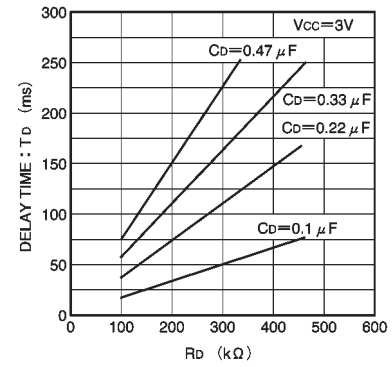

Fig. 16 Mute detection time vs. resistance Rd

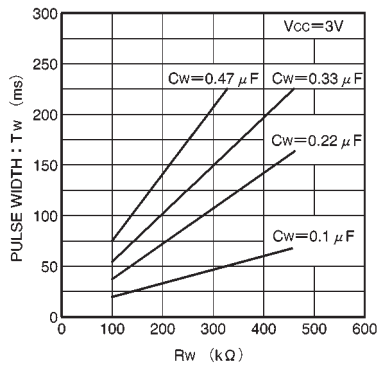

Fig. 17 Output pulse width vs. resistance Rw

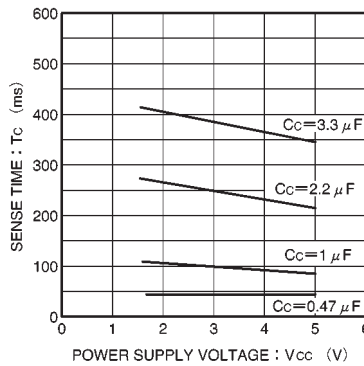

Fig. 18 Song detection time vs. power supply voltage

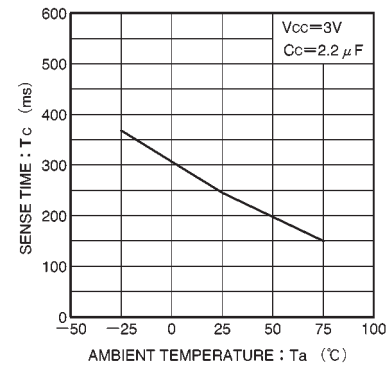

Fig. 19 Song detection time vs. ambient temperature

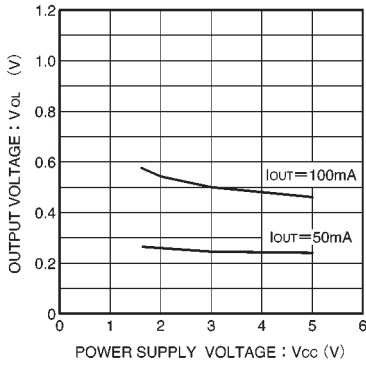

Fig. 20 Output voltage vs. power supply voltage

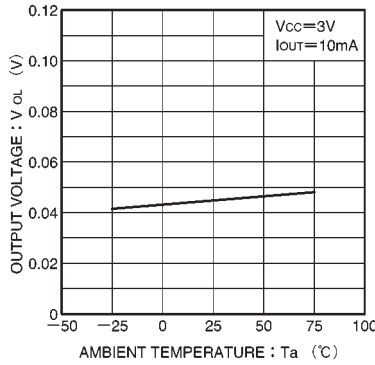

Fig. 21 Output voltage vs. ambient temperature

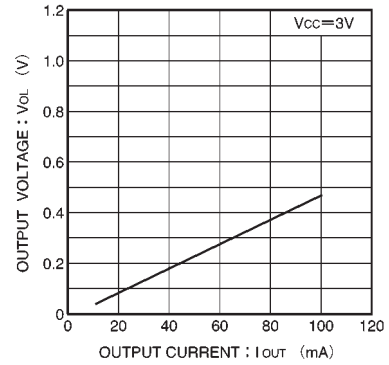

Fig. 22 Output voltage vs. output current

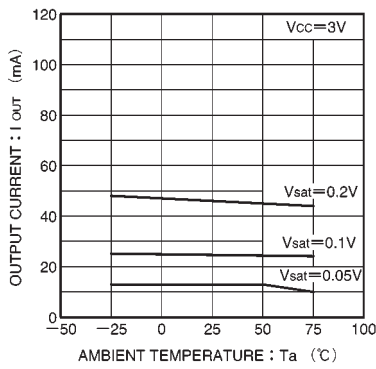

Fig. 23 Output current vs. ambient temperature

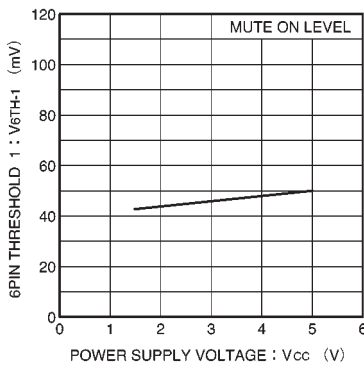

Fig. 24 6pin threshold voltage1 vs. power supply voltage

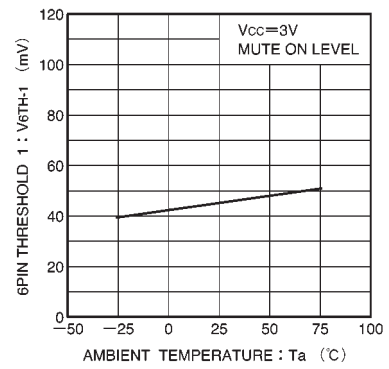

Fig. 25 6pin threshold voltage1 vs. power supply voltage

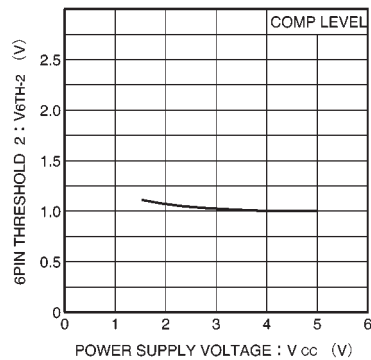

Fig. 26 6pin threshold voltage2 vs. power supply voltage

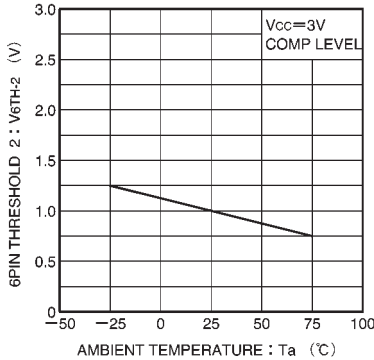

Fig. 27 6pin threshold voltage2 vs. ambient temperature

●Application board pattern and component layout

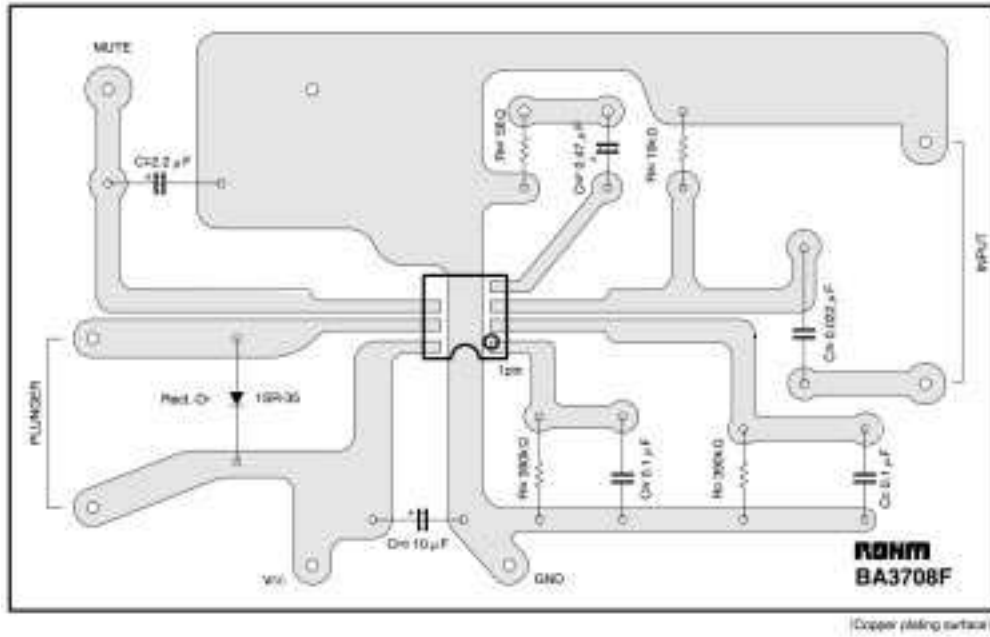

Fig. 28

●External dimensions (Units: mm)

