

élantec

HIGH PERFORMANCE ANALOG INTEGRATED CIRCUITS

EL2232/EL2232C

60 MHz, Fast Settling, Dual Current Mode Feedback Amplifier

ELANTEC INC

T-79-25

EL2232/EL2232C

Features

- 60 MHz -3 dB bandwidth, $A_V = 1$
- 50 MHz -3 dB bandwidth, $A_V = 2$
- 3 mV offset voltage
- 10 $\mu\text{V}/^\circ\text{C}$ Offset Drift
- 600 V/ μs Slew Rate
- 30 mA output current
- Drives ± 12.5 into 500 Ω load
- Characterized at $\pm 5\text{V}$ and $\pm 15\text{V}$
- 9.5 mA supply current
- 125 ns settling time to 0.02% for 10V step
- Output short circuit protected
- Low cost
- Dual version of the EL2020

Applications

- Video amplifiers
- Video distribution amplifiers
- Fast, precise D/A converter output amplifier
- High speed A/D input amplifier
- CCD imager amplifier
- Ultrasound and sonar systems

Ordering Information

Part No.	Temp. Range	Package	Outline#
EL2232CN	0°C to +75°C	8-Pin P-DIP	MDP0031
EL2232CM	0°C to +75°C	16-Lead SOL	MDP0027
EL2232J	-55°C to +125°C	8-Pin CerDIP	MDP0001
EL2232J/883B	-55°C to +125°C	8-Pin CerDIP	MDP0001
EL2232L/883B	-55°C to +125°C	20-Pin LCC	MDP0007

5962 9167501 is the SMD version of this part.

General Description

The EL2232 is a dual monolithic operational amplifier with a 60 MHz unity gain bandwidth. Built using Elantec's in-house high speed bipolar process, the dual amplifier uses current mode feedback to achieve more bandwidth at a given gain than a conventional voltage feedback operational amplifier. The EL2232 design was optimized to achieve fast rise and fall times and short settling times.

The EL2232 is a dual version of the popular EL2020, demonstrating similar AC performance, yet the 2 amplifiers of the EL2232 consume no more power than a single EL2020.

The EL2232 operates on standard $\pm 15\text{V}$ supplies, swings $\pm 12.5\text{V}$ at its output into a 500 Ω load. The EL2232 was designed and is characterized to operate with supply voltages between $\pm 5\text{V}$ and $\pm 15\text{V}$. Its low power consumption and short circuit protection make the EL2232 a safe and reliable amplifier to be used in commercial, industrial and military applications where the part is available screened to MIL-STD-883.

Elantec's facilities comply with MIL-I-45208A and other applicable quality specifications. For information on Elantec's military processing, see the Elantec document, QRA-2: *Elantec's Military Processing—Monolithic Products*.

Connection Diagrams

CerDIP Package

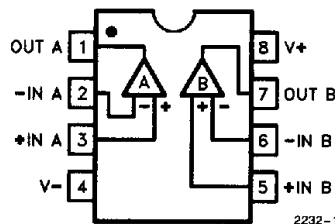

Top View

LCC EL2232L

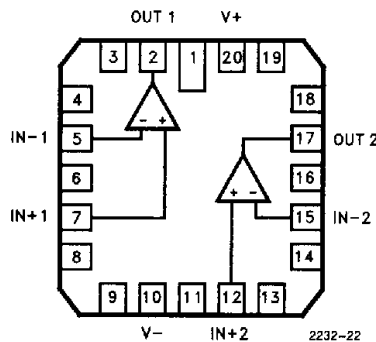

Top View

SOL Package

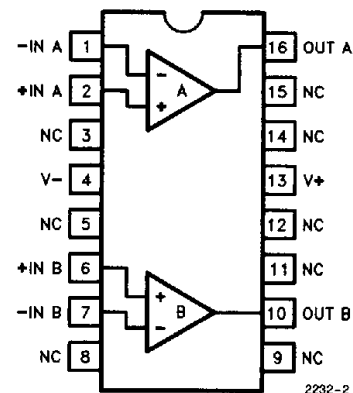

Top View

Plastic DIP

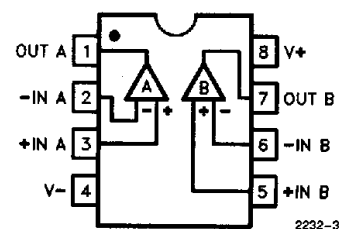

Top View

EL2232/EL2232C

ELANTEC INC

60 MHz, Fast Settling, Dual Current Mode Feedback Amplifier**Absolute Maximum Ratings** ($T_A = 25^\circ\text{C}$)

V_S	Supply Voltage	$\pm 18\text{V}$ or 36V	T_J	Operating Junction Temperature	
V_{IN}	Input Voltage	$\pm 15\text{V}$ or V_S		Ceramic Packages	175°C
ΔV_{IN}	Differential Input Voltage	$\pm 6\text{V}$		Plastic Packages	150°C
P_D	Maximum Power Dissipation	See Curves	T_{ST}	Storage Temperature	-65°C to $+150^\circ\text{C}$
I_{IN}	Input Current	$\pm 10\text{mA}$		Lead Temperature	
I_{OP}	Peak Output Current	Short Circuit Protected		DIP Package	
	Output Short Circuit Duration	Continuous		(Soldering, <10 seconds)	300°C
	(Note 1)			SOL Package	
T_A	Operating Temperature Range			Vapor Phase (60 seconds)	215°C
	EL2232	-55°C to $+125^\circ\text{C}$		Infrared (15 seconds)	220°C
	EL2232C	0°C to $+75^\circ\text{C}$			

Important Note:

All parameters having Min/Max specifications are guaranteed. The Test Level column indicates the specific device testing actually performed during production and Quality Inspection. Elantec performs most electrical tests using modern high-speed automatic test equipment, specifically the LTX77 Series system. Unless otherwise noted, all tests are pulsed tests, therefore $T_J = T_C = T_A$.

Test Level	Test Procedure
I	100% production tested and QA sample tested per QA test plan QCX0002.
II	100% production tested at $T_A = 25^\circ\text{C}$ and QA sample tested at $T_A = 25^\circ\text{C}$, T_{MAX} and T_{MIN} per QA test plan QCX0002.
III	QA sample tested per QA test plan QCX0002.
IV	Parameter is guaranteed (but not tested) by Design and Characterization Data.
V	Parameter is typical value at $T_A = 25^\circ\text{C}$ for information purposes only.

Open Loop DC Electrical Characteristics $V_S = \pm 15\text{V}$, $R_L = 500\Omega$, unless otherwise specified

Parameter	Description	Condition	Temp	Min	Typ	Max	Test Level		Units
							EL2232	EL2232C	
V_{OS}	Input Offset Voltage	$V_S = \pm 5\text{V}, \pm 15\text{V}$	25°C		2	7	I	I	mV
			T_{MIN}, T_{MAX}			10	I	III	mV
dV_{OS}/dT	Offset Voltage Drift		Full		10		V	V	$\mu\text{V}/^\circ\text{C}$
$+I_{IN}$	+ Input Current	$V_S = \pm 5\text{V}, \pm 15\text{V}$	25°C		1.2	5	I	I	μA
			T_{MIN}, T_{MAX}			7.5	I	III	μA
$-I_{IN}$	- Input Current	$V_S = \pm 5\text{V}, \pm 15\text{V}$	25°C		5	20	I	I	μA
			T_{MIN}, T_{MAX}			25	I	III	μA
$+R_{IN}$	+ Input Resistance		Full	2	20		I	II	$\text{M}\Omega$
C_{IN}	Input Capacitance		25°C		3		V	V	pF
CMRR	Common Mode Rejection Ratio (Note 2)	$V_S = \pm 5\text{V}, \pm 15\text{V}$	Full	56	63		I	II	dB
			25°C		0.25	0.75	I	I	$\mu\text{A}/\text{V}$
$-ICMR$	Input Current Common-Mode Rejection (Note 2)		T_{MIN}, T_{MAX}			1	I	II	$\mu\text{A}/\text{V}$
			Full	66	80		I	II	dB
$+IPSR$	+ Input Current Power Supply Rejection (Note 3)		25°C		0.03	0.06	I	II	$\mu\text{A}/\text{V}$
			T_{MIN}, T_{MAX}			0.1	I	III	$\mu\text{A}/\text{V}$
$-IPSR$	- Input Current Power Supply Rejection (Note 3)		25°C		0.06	0.2	I	II	$\mu\text{A}/\text{V}$
			T_{MIN}, T_{MAX}			0.3	I	III	$\mu\text{A}/\text{V}$
R_{OL}	Transimpedance ($dV_{OUT}/d-I_{IN}$) (Note 4)	$V_S = \pm 5\text{V}, \pm 15\text{V}$	25°C	0.75	1.3		I	II	$\text{M}\Omega$
			T_{MIN}, T_{MAX}	0.60			I	III	$\text{M}\Omega$

ELANTEC INC

EL2232/EL2232C**60 MHz, Fast Settling, Dual Current Mode Feedback Amplifier**

EL2232/EL2232C

Open Loop DC Electrical Characteristics $V_S = \pm 15V$, $R_L = 500\Omega$, unless otherwise specified — Contd.

Parameter	Description	Condition	Temp	Min	Typ	Max	Test Level		Units
							EL2232	EL2232C	
V_O	Output Voltage Swing	$V_S = \pm 15V$ $R_L = 500\Omega$	Full	11.5	12.5		I	II	V
		$V_S = \pm 5V$ $R_L = 500\Omega$	Full	2	2.5		I	II	V
I_{OUT}	Output Current	$V_S = \pm 15V$	Full	23	30		I	II	mA
		$V_S = \pm 5V$	Full		25		V	V	mA
I_S	Quiescent Supply Current		25°C		9.5	13	I	II	mA
			T_{MIN}, T_{MAX}			14	I	III	mA
I_{SC}	Short-Circuit Current	$V_S = \pm 15V$	25°C		50		V	V	mA
		$V_S = \pm 5V$	25°C		45		V	V	mA

Closed Loop AC Electrical Characteristics $V_S = \pm 15V$, $A_V = +1$, $R_F = 1.5k\Omega$, $R_L = 500\Omega$, $T_A = 25^\circ C$

Parameter	Description	Condition	Temp	Min	Typ	Max	Test Level		Units
							EL2232	EL2232C	
SR	Slew Rate (Note 5)	$A_V = +1$	25°C	400	600		I	I	V/ μs
		$A_V = +10$	25°C		650		V	V	V/ μs
BW	-3 dB Bandwidth	$A_V = -1$	25°C		50		V	V	MHz
		$A_V = +1$	25°C		60		V	V	MHz
		$A_V = +10$	25°C		35		V	V	MHz
t_r, t_f	Rise Time, Fall Time $A_V = +1$, 10% to 90%	100 mV Step	25°C		8		V	V	ns
		10V Step	25°C		21		V	V	ns
t_s	Settling Time (Note 6)	$A_V = -1$, 0.1%	25°C		85		V	V	ns
		0.02%	25°C		120		V	V	ns
		$A_V = +1$, 0.1%	25°C		85		V	V	ns
		0.02%	25°C		110		V	V	ns
		$A_V = +10$, 0.1%	25°C		85		V	V	ns
		0.02%	25°C		125		V	V	ns
CS	Channel Separation	100 kHz, $R_L = 1M\Omega$	25°C		100		V	V	dB
dG	Differential Gain (Note 7)	$R_L = 150\Omega$	25°C		0.1		V	V	% p-p
dPhase	Differential Phase (Note 7)	$R_L = 150\Omega$	25°C		0.1		V	V	° p-p

Note 1: A heat sink is required to keep junction temperature below absolute maximum when an output is shorted.

Note 2: $V_{CM} = \pm 10V$ for $V_S = \pm 15V$. For $V_S = \pm 5V$, $V_{CM} = \pm 2V$.Note 3: V_{OS} is measured at $V_S = \pm 4.5V$ and at $V_S = \pm 18V$. Both supplies are changed simultaneously.Note 4: $R_L = 500\Omega$, $V_O = \pm 10V$ for $V_S = \pm 15V$, $V_O = \pm 2V$ for $V_S = \pm 5V$.Note 5: $V_O = \pm 10V$, SR is tested at $V_O = \pm 5V$.

Note 6: Setting time measurement techniques are shown in: "Take The Guesswork Out of Settling Time Measurements", EDN, September 19, 1985. Available from the factory upon request.

Note 7: NTSC (3.58 MHz) and PAL (4.43 MHz). See Differential Gain and Phase Test Circuit.

EL2232/EL2232C

ELANTEC INC

60 MHz, Fast Settling, Dual Current Mode Feedback Amplifier

Typical Performance Curves

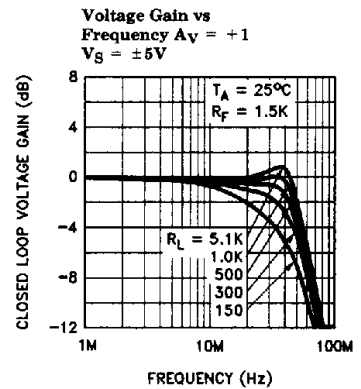
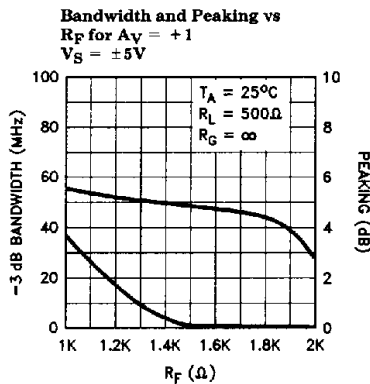
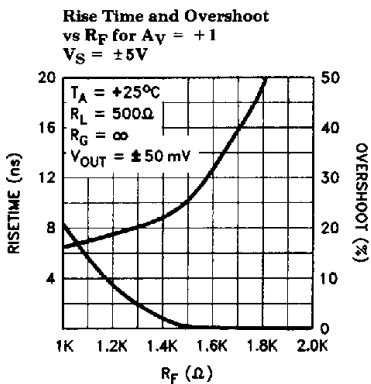
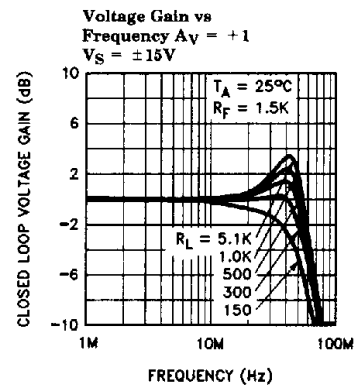
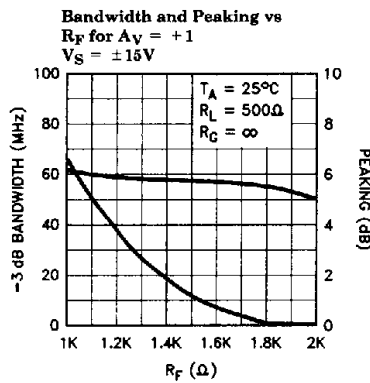
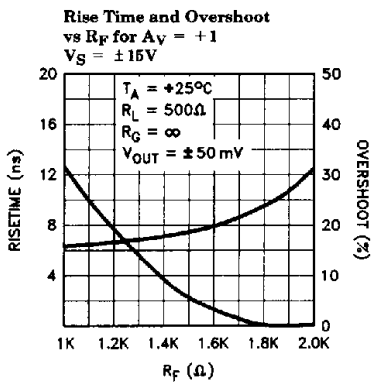
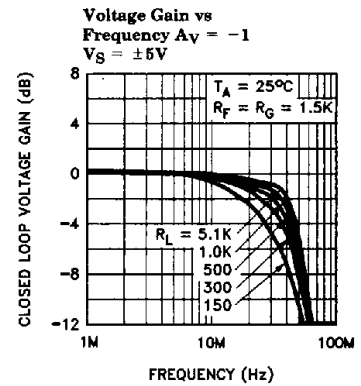
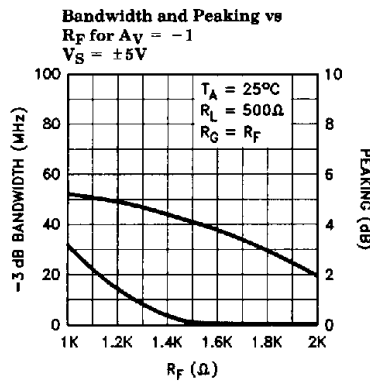
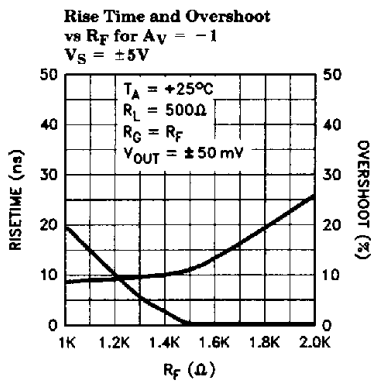
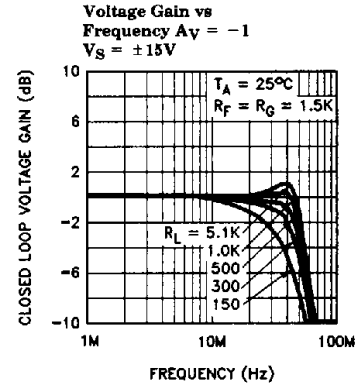
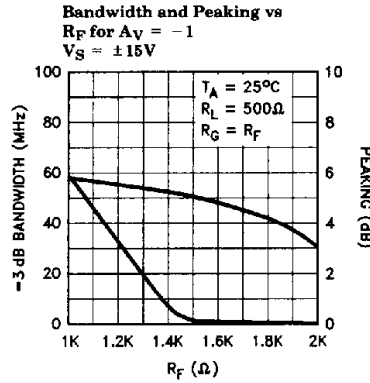
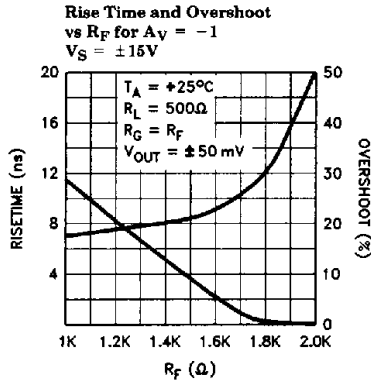

ELANTEC INC

EL2232/EL2232C

60 MHz, Fast Settling, Dual Current Mode Feedback Amplifier

EL2232/EL2232C

Typical Performance Curves — Contd.

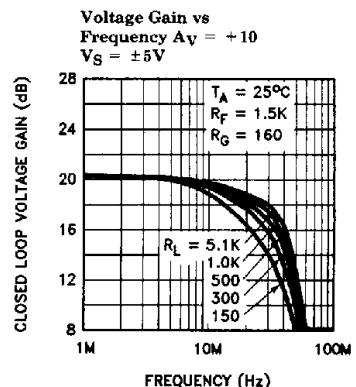
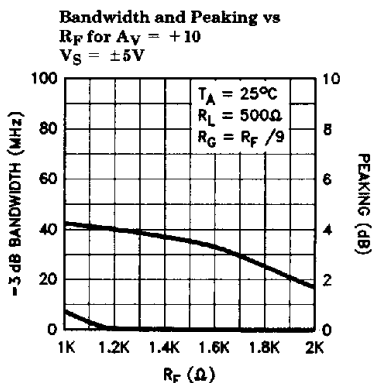
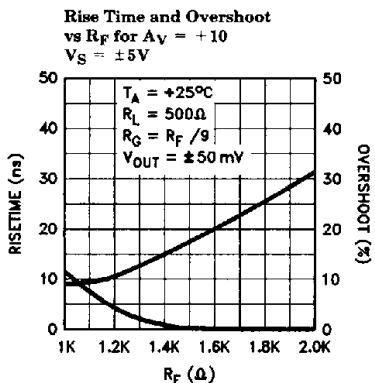
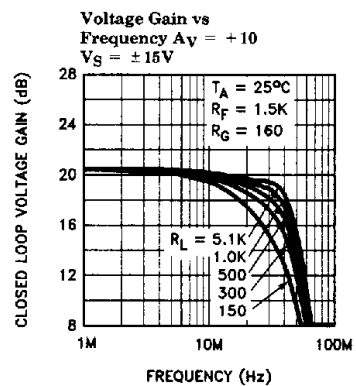
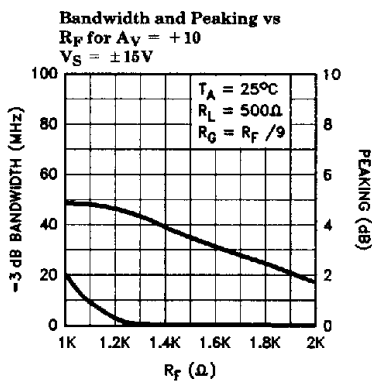
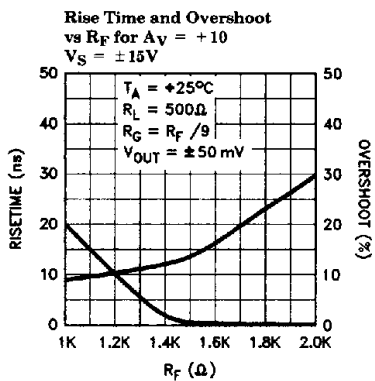
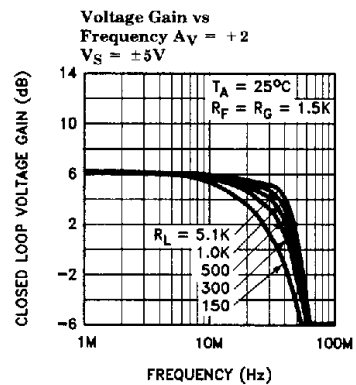
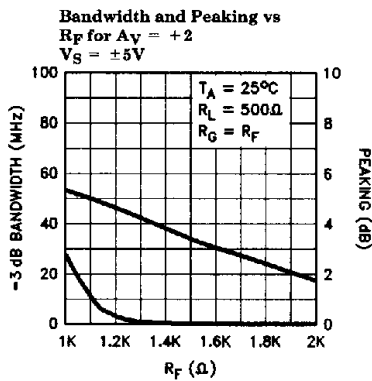
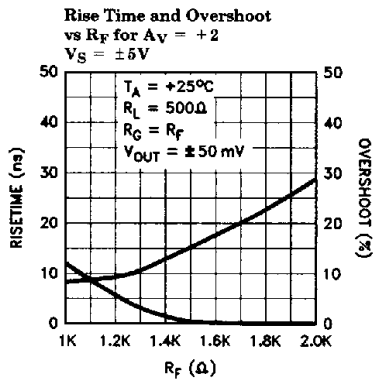
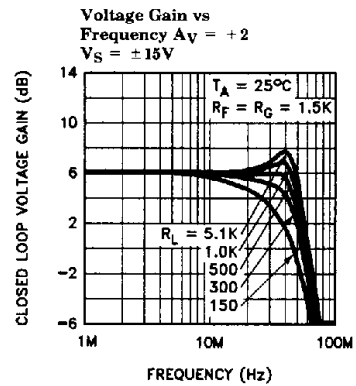
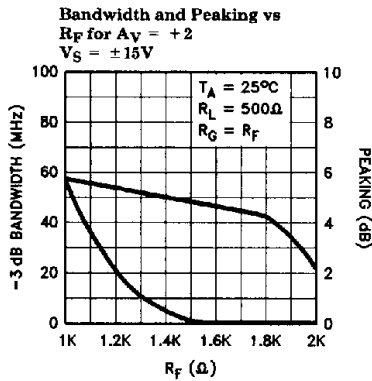
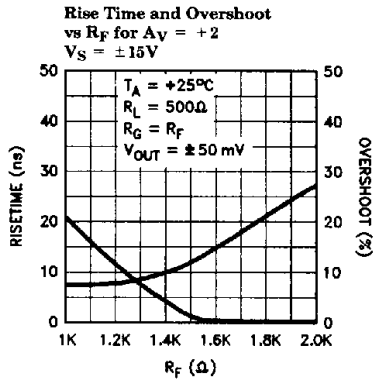

1

EL2232/EL2232C

ELANTEC INC

60 MHz, Fast Settling, Dual Current Mode Feedback Amplifier

Typical Performance Curves — Contd.

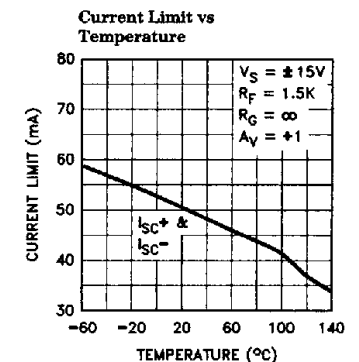
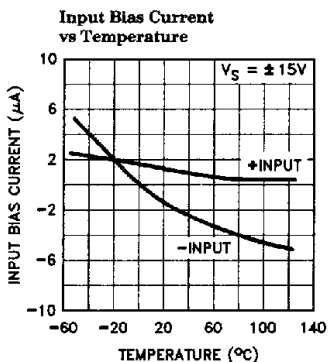
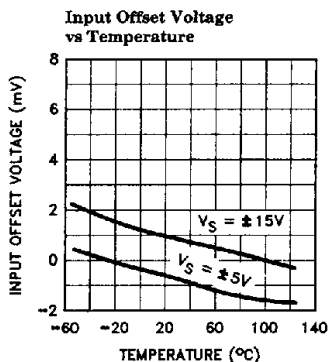
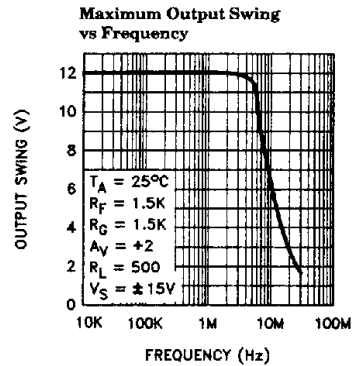
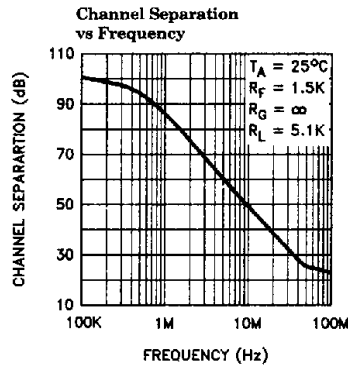
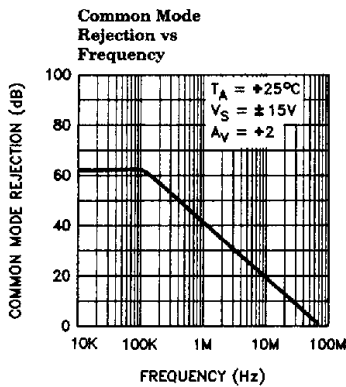
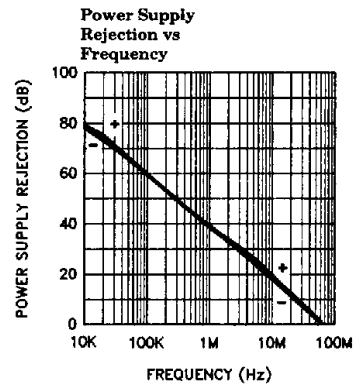
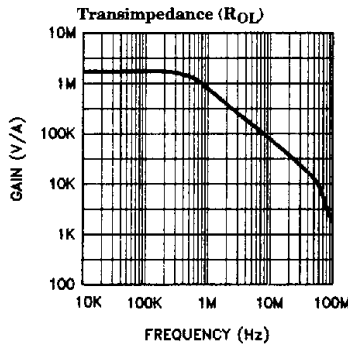
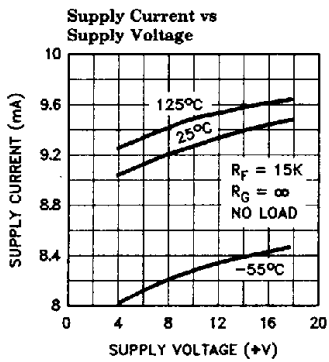
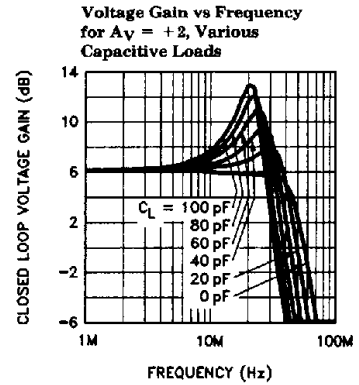
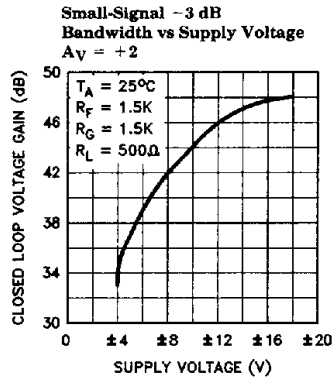
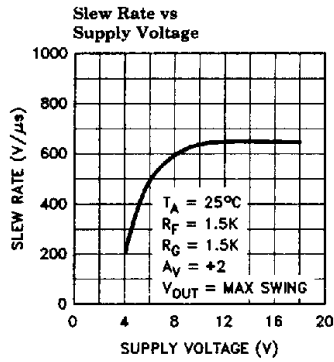

ELANTEC INC

EL2232/EL2232C

60 MHz, Fast Settling, Dual Current Mode Feedback Amplifier

EL2232/EL2232C

Typical Performance Curves — Contd.

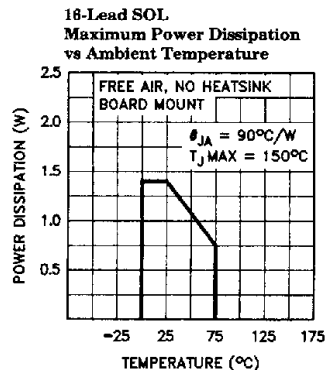
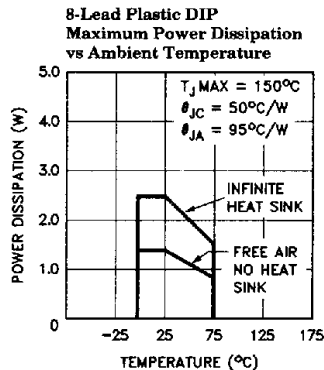
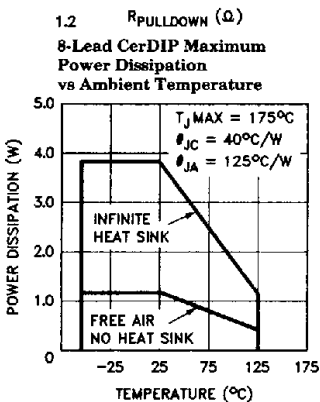
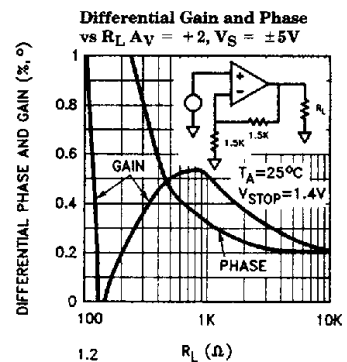
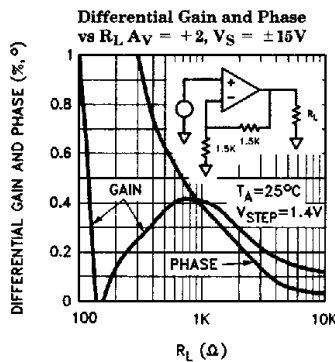
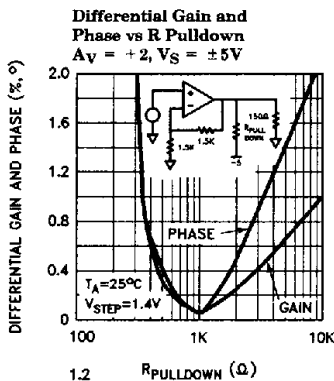
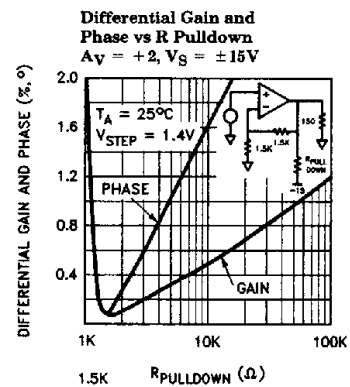
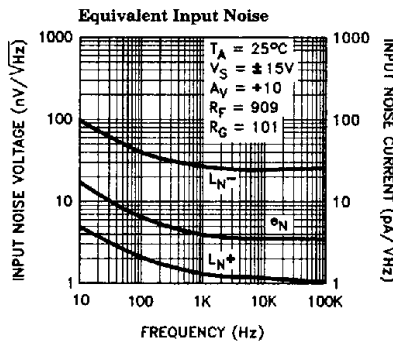
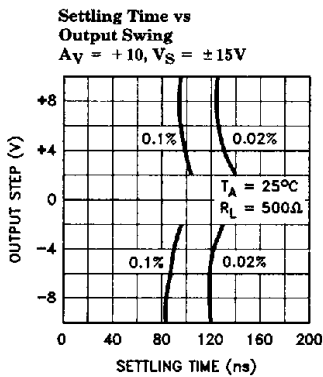
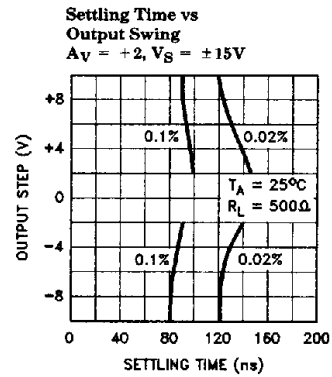
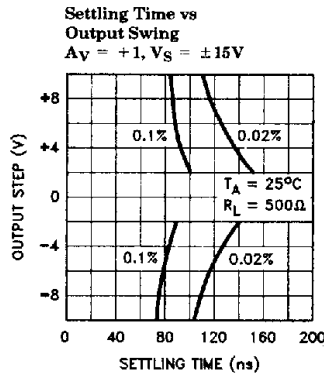
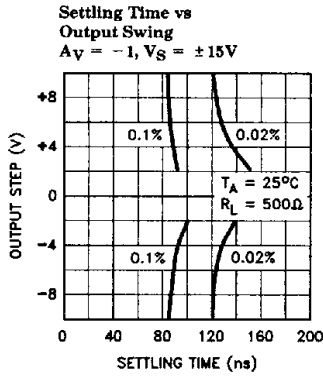

1

EL2232/EL2232C

ELANTEC INC

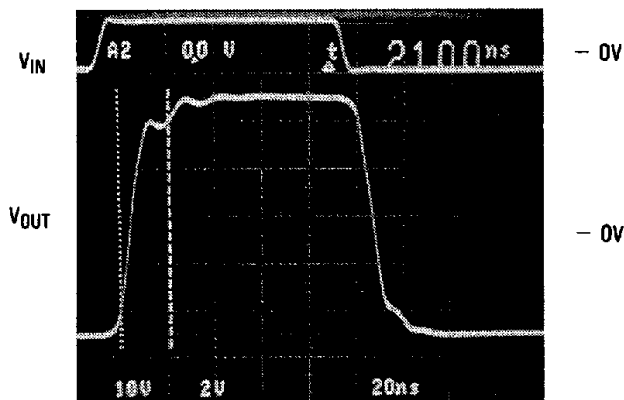
60 MHz, Fast Settling, Dual Current Mode Feedback Amplifier**Typical Performance Curves — Contd.****Large Signal Response**

$A_V = +1$, $R_F = 1.5k$,
 $R_L = 500\Omega$, $V_S = \pm 15V$

2232-8

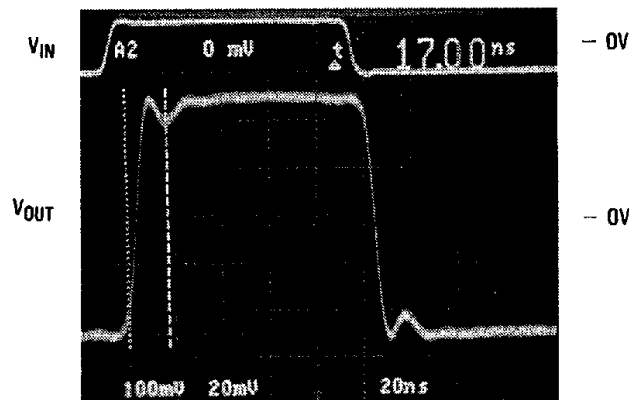
Small Signal Response

$A_V = +1$, $R_F = 1.5k$,
 $R_L = 500\Omega$, $V_S = \pm 15V$

2232-9

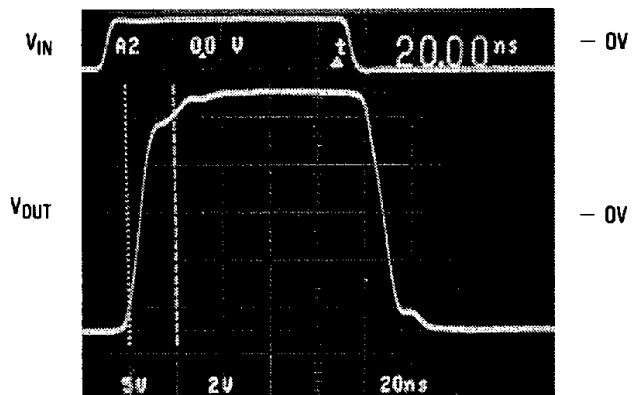
Large Signal Response

$A_V = +2$, $R_F = R_G = 1.5k$,
 $R_L = 500\Omega$, $V_S = \pm 15V$

2232-10

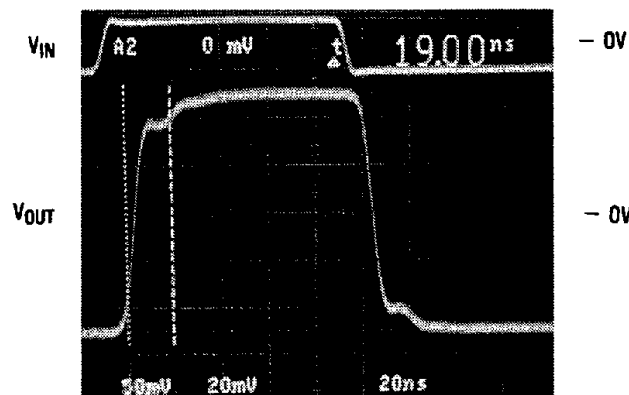
Small Signal Response

$A_V = +2$, $R_F = R_G = 1.5k$,
 $R_L = 500\Omega$, $V_S = \pm 15V$

2232-11

ELANTEC INC

EL2232/EL2232C

60 MHz, Fast Settling, Dual Current Mode Feedback Amplifier

EL2232/EL2232C

Typical Performance Curves — Contd.

Large Signal Response

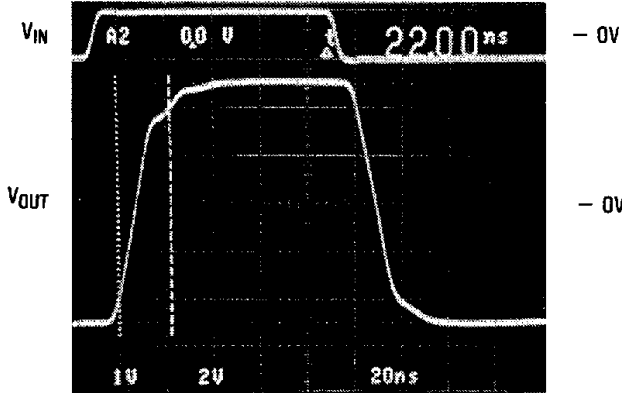

$A_V = +10$, $R_F = 1.5k$, $R_G = 167$,
 $R_L = 500\Omega$, $V_S = \pm 15V$

2232-12

Small Signal Response

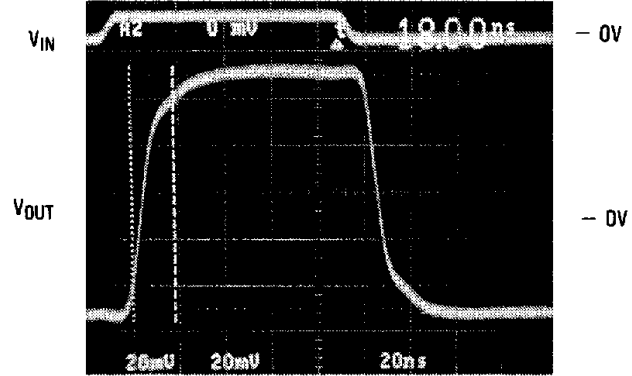

$A_V = +10$, $R_F = 1.5k$, $R_G = 167$,
 $R_L = 500\Omega$, $V_S = \pm 15V$,

2232-13

Burn-In Circuit

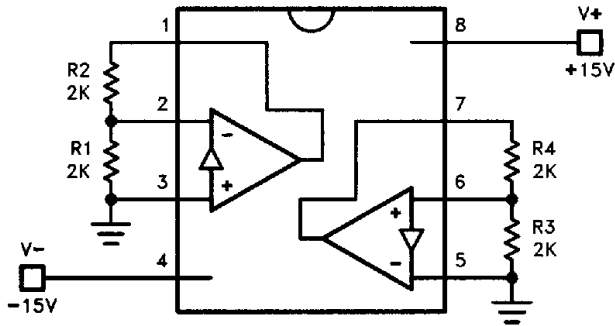

2232-14

Test Circuit

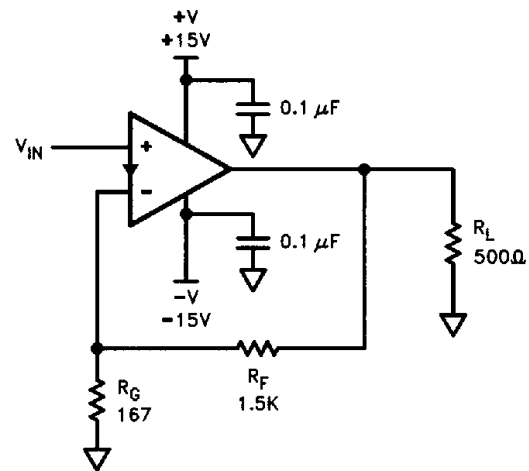

2232-15

Differential Gain and Phase Test Circuit

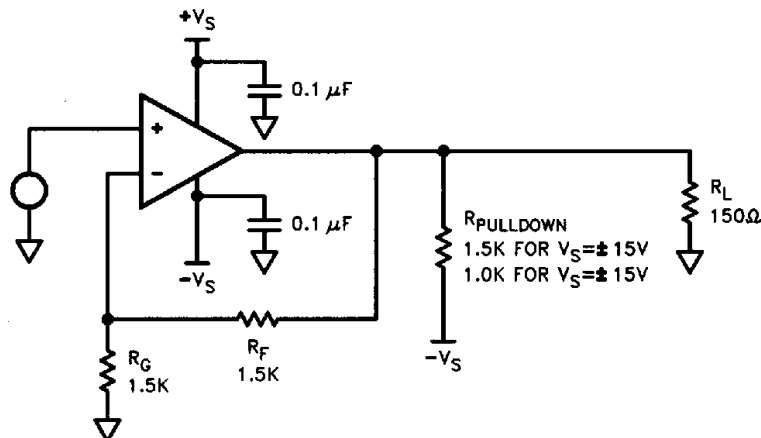

2232-16

EL2232/EL2232C

ELANTEC INC

60 MHz, Fast Settling, Dual Current Mode Feedback Amplifier

Applications Information

Product Description

The EL2232 is a dual current-mode feedback amplifier similar to the industry-standard EL2020. Each of the EL2232's amplifiers has greater -3 dB bandwidth (60 MHz) and slew-rate (600 V/ μ s) than the EL2020, yet the total supply current for the EL2232 (9.5 mA) is only slightly more than the EL2020. Furthermore, the EL2232 has been characterized at both $V_S = \pm 5$ V and $V_S = \pm 15$ V.

With two amplifiers in a single package, the EL2232 allows 2-channel amplification with matched performance, as well as reduction of PC board area when compared to 2 single amplifiers. Designing with the EL2232 is simple, since in most applications it performs similarly to a conventional voltage-feedback operational amplifier.

Power Supply Bypassing/Lead Dressing

It is important to bypass the power supplies of the EL2232 with 0.1 μ F or 0.01 μ F ceramic disc capacitors. A 4.7 μ F tantalum capacitor is also recommended for each supply. These capacitors should be placed as close to the package as possible, and long lead lengths should be avoided. Failure to bypass the supplies in this manner will result in oscillation or signal distortion.

The $-$ input of the EL2232 is fairly sensitive to stray capacitance, therefore it is important for

the feedback and gain-setting resistors to be as close as possible to the $-$ input. It is also a good idea to remove the PC board ground-plane near the $-$ input.

Current Limit

The EL2232 has an internal current limit of approximately 50 mA per amplifier, so if one of the outputs is shorted to ground (with $V_S \pm 15$ V) the power dissipation could be as much as 1.1W. A heatsink is therefore required to survive an indefinite short at one of the outputs. If both of the outputs are shorted, power dissipation can approach 2W, resulting in the eventual destruction of the device, even with a heatsink.

Video Performance

To keep total supply current for the EL2232 at 9.5 mA, the output stage idle current had to be reduced substantially from the values used in the EL2020. As a consequence, a pulldown resistor is needed at the output of the EL2232 to achieve good video performance when driving the standard 150 Ω double-terminated load. As seen in the Differential Gain and Phase Test Schematic, with ± 15 V rails a 1.5k pulldown resistor from the output to the -15 V rail gives good video performance (0.1% dG 0.1 $^\circ$ dP). With 5V rails, a 1k resistor gives similar results. These resistor values will vary with different load impedances, but in general the video performance improves as load impedance increases.

Adding a Pulldown Resistor to Improve Video Performance

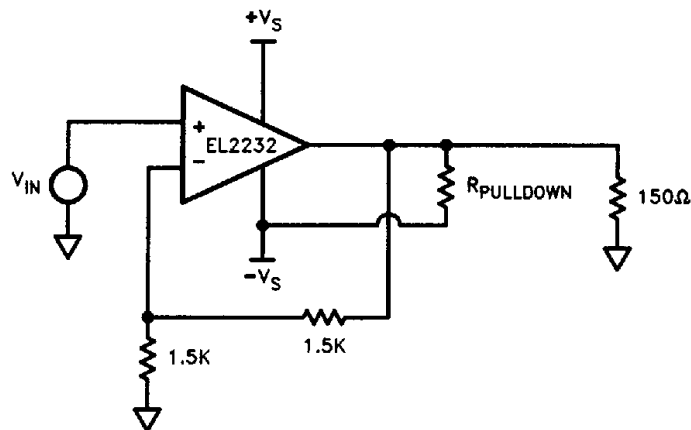

2232-17

ELANTEC INC

EL2232/EL2232C

60 MHz, Fast Settling, Dual Current Mode Feedback Amplifier

EL2232/EL2232C

1

Applications Information — Contd.

Capacitive Loading/ Snubbing

The EL2232 has been designed to be stable in most situations with purely capacitive loads of up to about 50 pF. With 500Ω in parallel with the load capacitance, the EL2232 is usually stable with load capacitances of up to 100 pF, and often more (see the Cload vs Peaking curve). As expected with any high speed amplifier, the capacitive loading will increase the peaking of the closed loop frequency response (and therefore overshoot and ringing in the time domain) due to the decreased phase margin of the amplifier.

The use of an output snubber can be a valuable technique for improving stability when driving large capacitive loads. The output snubber is simply a series RC network placed from the output to ground, so that at high frequencies the amplifier is driving the load capacitance in parallel with a low value resistance (the snubber R). At low frequencies, the capacitance of the snubber is a high enough impedance so that the load looks

the same as if the snubber were not tied to the output.

Selection of the R and C for the snubber is fairly simple. First, an R is selected to reduce peaking. As seen in the Frequency Response vs RL curves, the EL2232 has dramatically reduced peaking with a 150Ω load, so this is a good starting value. The resistor is then placed from the output to ground, and its value is varied until the desired response has been achieved. The capacitor is then chosen so that the corner frequency of the RC snubber is below the frequency of the peaking. Looking at the Cload vs Peaking Curve, the peaking is generally in the 20 MHz range for a gain of 2. Setting the corner frequency at 10 MHz, we get $C_{snubber} = 1/(2\pi * R_{snubber} * 10 \text{ MHz}) = 100 \text{ pF}$. This capacitance is then put in series with the snubber resistor and adjusted to achieve the desired response. As seen in the photograph, a 150Ω/100 pF snubber in conjunction with a 68 pF load reduces peaking from 5.8 dB down to a respectable 2.4 dB.

Adding An Output Snubber to Tame Capacitive Loads

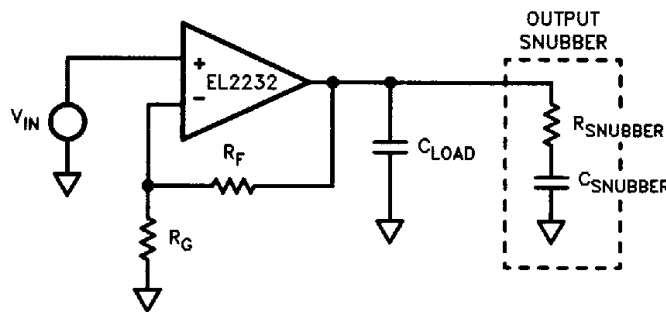

2232-18

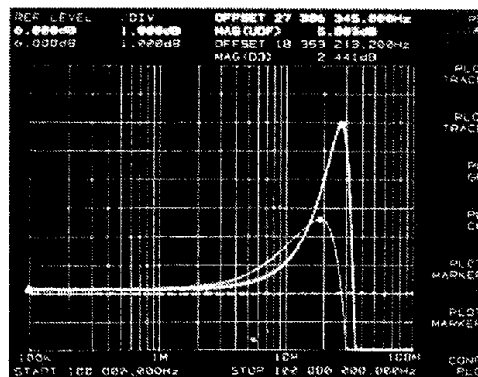

2232-19

EL2232 Frequency response with and without 150Ω/100 pF output snubber $C_L = 68 \text{ pF}$

EL2232/EL2232C

ELANTEC INC

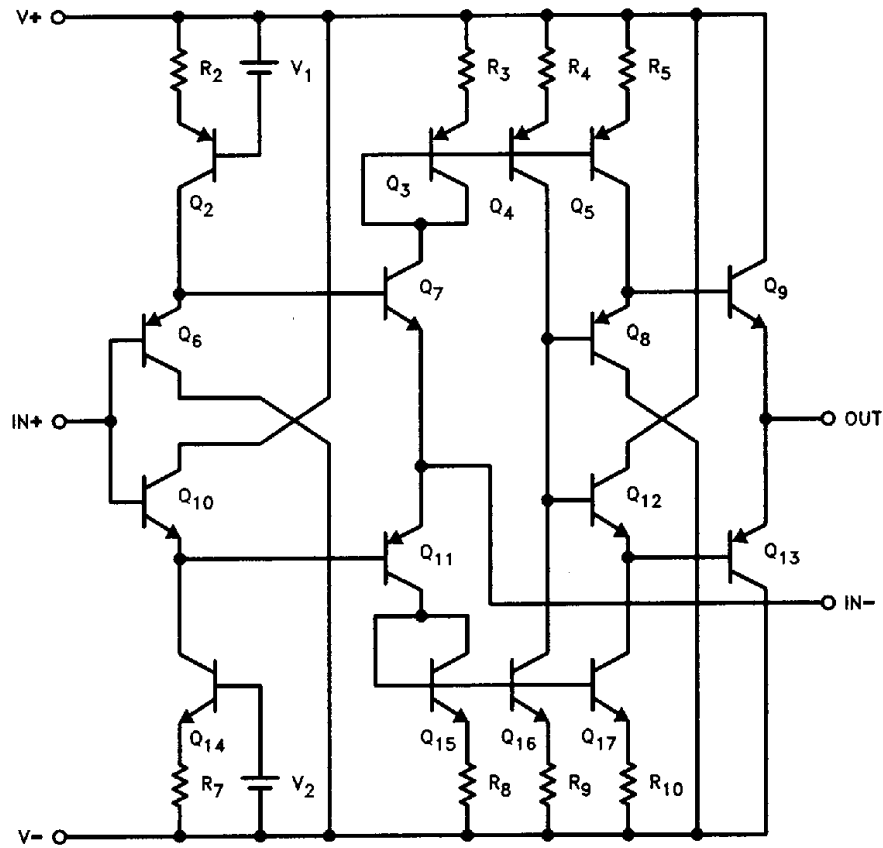
60 MHz, Fast Settling, Dual Current Mode Feedback Amplifier**Applications Information — Contd.****Equivalent Circuit (One of Two Amplifiers)**

2232-20

ELANTEC INC

EL2232/EL2232C**60 MHz, Fast Settling, Dual Current Mode Feedback Amplifier**

EL2232/EL2232C

EL2232 Macromodel

* Revision A. March 1992

* Enhancements include PSRR, CMRR, and Slew Rate Limiting

```

* Connections:  + input
*               |
*               | - input
*               |   + Vsupply
*               |   - Vsupply
*               |   output
*               |
.subckt M2232  3  2  8  4  1

```

* Input Stage

```

*
e1 10 0 3 0 1.0
vis 10 9 0V
h2 9 12 vxx 1.0
r1 2 11 50
l1 11 12 29nH
iinp 3 0 1.2μA
iinm 2 0 5μA

```

* Slew Rate Limiting

```

*
h1 13 0 vis 600
r2 13 14 10
d1 14 0 dclamp
d2 0 14 dclamp

```

* High Frequency Pole

```

*
*e2 30 0 14 0 0.001666666666
e2 30 0 14 0 0.001
15 30 17 1.5μH
c5 17 0 1pF
r5 17 0 500

```

* Transimpedance Stage

```

*
g1 0 18 17 0 1.0
rol 18 0 2Meg
cdp 18 0 2.5pF

```

* Output Stage

```

*
q1 4 18 19 qp
q2 8 18 20 qn
q3 8 19 21 qn
q4 4 20 22 qp
r7 21 1 5
r8 22 1 5

```

1

EL2232/EL2232C

ELANTEC INC

60 MHz, Fast Settling, Dual Current Mode Feedback Amplifier**EL2232 Macromodel — Contd.**

ios1 8 19 1mA

ios2 20 4 1mA

*

* Supply

*

ips 8 4 2mA

*

* Error Terms

*

ivos 0 23 2mA

vxx 23 0 0V

e4 24 0 1 0 1.0

e5 25 0 8 0 1.0

e6 26 0 4 0 1.0

r9 24 23 1 4K

r10 25 23 10K

r11 26 23 10K

*

* Models

*

.model qn npn (is = 5e - 15 bf = 250 tf = 0.1nS)

.model qp pnp (is = 5e - 15 bf = 250 tf = 0.1nS)

.model dclamp d(is = 1e - 30 ibv = 10pA bv = 0.8 n = 4)

.ends

ELANTEC INC

EL2232/EL2232C

60 MHz, Fast Settling, Dual Current Mode Feedback Amplifier

EL2232/EL2232C

EL2232 Macromodel — Contd.

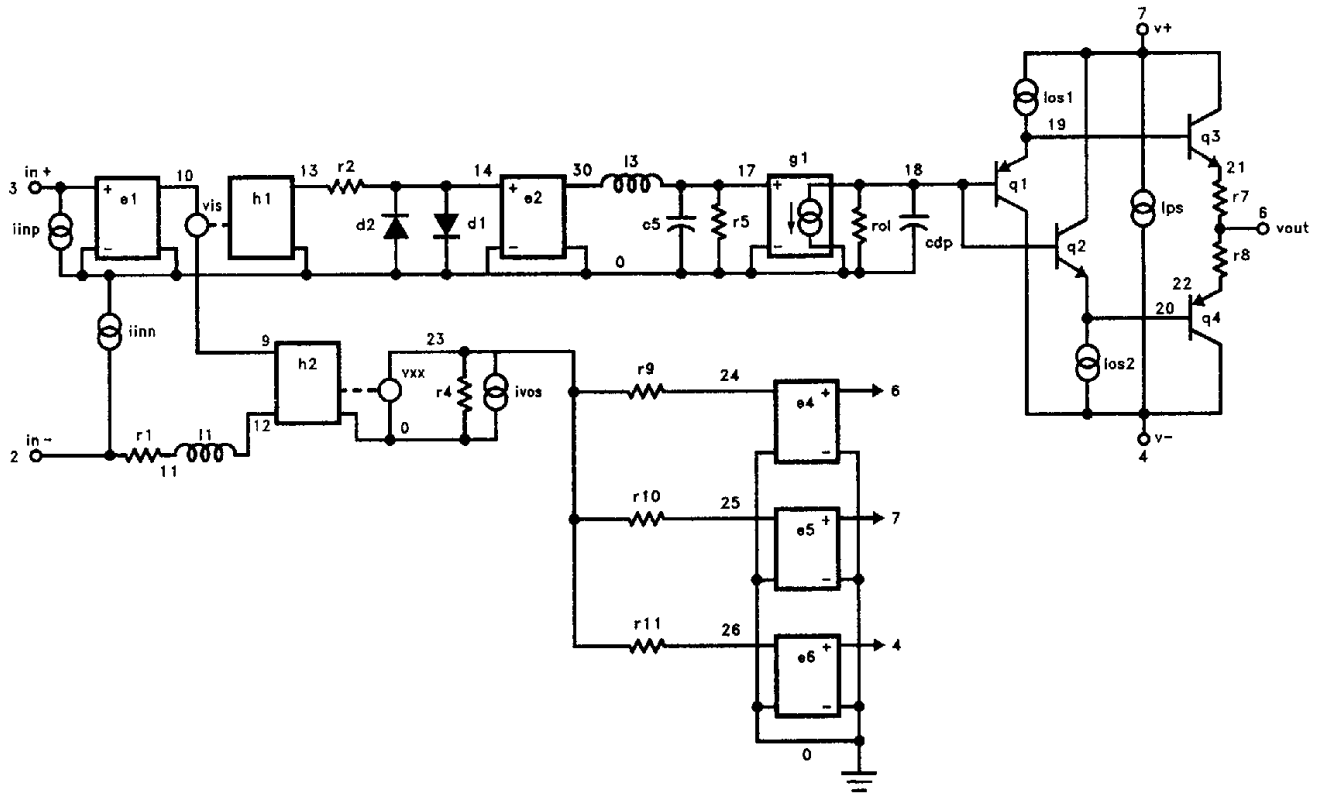

2232-21

1