

12MHz Rail-to-Rail Input-Output Op Amps

The EL5120, EL5220, and EL5420 are low power, high voltage, rail-to-rail input-output amplifiers. The EL5120 contains a single amplifier, the EL5220 contains two amplifiers, and the EL5420 contains four amplifiers. Operating on supplies ranging from 5V to 15V, while consuming only 500 μ A per amplifier, the EL5120, EL5220, and EL5420 have a bandwidth of 12MHz (-3dB). They also provide common mode input ability beyond the supply rails, as well as rail-to-rail output capability. This enables these amplifiers to offer maximum dynamic range at any supply voltage.

The EL5120, EL5220, and EL5420 also feature fast slewing and settling times, as well as a high output drive capability of 30mA (sink and source). These features make these amplifiers ideal for use as voltage reference buffers in Thin Film Transistor Liquid Crystal Displays (TFT-LCD). Other applications include battery power, portable devices, and anywhere low power consumption is important.

The EL5420 is available in the space-saving 14-pin TSSOP package, the industry-standard 14-pin SO package, as well as the 16-pin QFN package. The EL5220 is available in the 8-pin MSOP package and the EL5120 is available in the 5-pin TSOT and 8-pin HMSOP packages. All feature a standard operational amplifier pin out. These amplifiers are specified for operation over the full -40°C to +85°C temperature range.

Features

- 12MHz -3dB bandwidth
- Supply voltage = 4.5V to 16.5V
- Low supply current (per amplifier) = 500 μ A
- High slew rate = 10V/ μ s
- Unity-gain stable
- Beyond the rails input capability
- Rail-to-rail output swing
- Ultra-small package
- Pb-Free available (RoHS compliant)

Applications

- TFT-LCD drive circuits
- Electronics notebooks
- Electronics games
- Touch-screen displays
- Personal communication devices
- Personal digital assistants (PDA)
- Portable instrumentation
- Sampling ADC amplifiers
- Wireless LANs
- Office automation
- Active filters
- ADC/DAC buffer

Ordering Information

PART NUMBER	PACKAGE	TAPE & REEL	PKG. DWG. #
EL5120IWT-T7	5-Pin TSOT	7" (3K pcs)	MDP0049
EL5120IWT-T7A	5-Pin TSOT	7" (250 pcs)	MDP0049
EL5120IWTZ-T7	5-Pin TSOT (Pb-Free)	7" (3K pcs)	MDP0049
EL5120IWTZ-T7A	5-Pin TSOT (Pb-Free)	7" (250 pcs)	MDP0049
EL5120IYE	8-Pin HMSOP	-	MDP0050
EL5120IYE-T7	8-Pin HMSOP	7"	MDP0050
EL5120IYE-T13	8-Pin HMSOP	13"	MDP0050
EL5120IYEZ	8-Pin HMSOP (Pb-Free)	-	MDP0050
EL5120IYEZ-T7	8-Pin HMSOP (Pb-Free)	7"	MDP0050
EL5120IYEZ-T13	8-Pin HMSOP (Pb-Free)	13"	MDP0050
EL5220CY	8-Pin MSOP	-	MDP0043
EL5220CY-T7	8-Pin MSOP	7"	MDP0043
EL5220CY-13	8-Pin MSOP	13"	MDP0043
EL5220CYZ	8-Pin MSOP (Pb-Free)	-	MDP0043
EL5220CYZ-T7	8-Pin MSOP (Pb-Free)	7"	MDP0043
EL5220CYZ-T13	8-Pin MSOP (Pb-Free)	13"	MDP0043
EL5420CL	16-Pin QFN	-	MDP0046
EL5420CL-T7	16-Pin QFN	7"	MDP0046
EL5420CL-T13	16-Pin QFN	13"	MDP0046

Ordering Information (Continued)

PART NUMBER	PACKAGE	TAPE & REEL	PKG. DWG. #
EL5420CLZ	16-Pin QFN (Pb-free)	-	MDP0046
EL5420CLZ-T7	16-Pin QFN (Pb-free)	7"	MDP0046
EL5420CLZ-T13	16-Pin QFN (Pb-free)	13"	MDP0046
EL5420CS	14-Pin SO	-	MDP0027
EL5420CS-T7	14-Pin SO	7"	MDP0027
EL5420CS-T13	14-Pin SO	13"	MDP0027
EL5420CSZ	14-Pin SO (Pb-free)	-	MDP0027
EL5420CSZ-T7	14-Pin SO (Pb-free)	7"	MDP0027
EL5420CSZ-T13	14-Pin SO (Pb-free)	13"	MDP0027
EL5420CR	14-Pin TSSOP	-	MDP0044
EL5420CR-T7	14-Pin TSSOP	7"	MDP0044
EL5420CR-T13	14-Pin TSSOP	13"	MDP0044
EL5420CRZ	14-Pin TSSOP (Pb-Free)	-	MDP0044
EL5420CRZ-T7	14-Pin TSSOP (Pb-Free)	7"	MDP0044
EL5420CRZ-T13	14-Pin TSSOP (Pb-Free)	13"	MDP0044

NOTE: Intersil Pb-free products employ special Pb-free material sets; molding compounds/die attach materials and 100% matte tin plate termination finish, which are RoHS compliant and compatible with both SnPb and Pb-free soldering operations. Intersil Pb-free products are MSL classified at Pb-free peak reflow temperatures that meet or exceed the Pb-free requirements of IPC/JEDEC J STD-020.

Pinouts

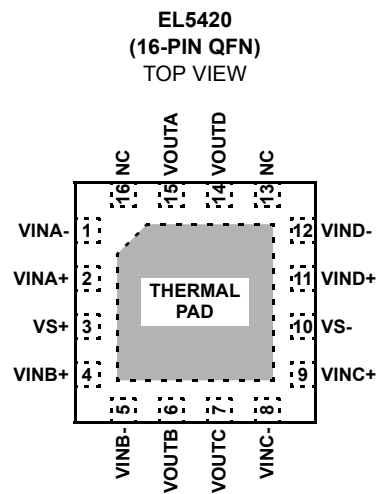
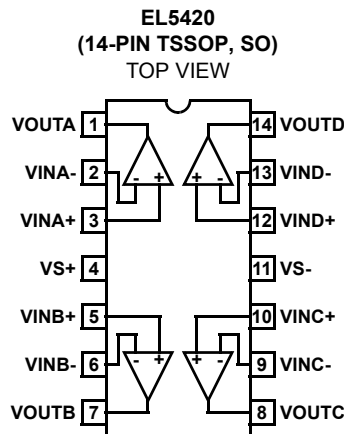
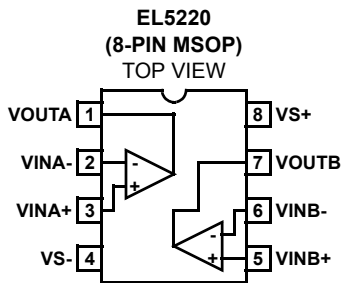
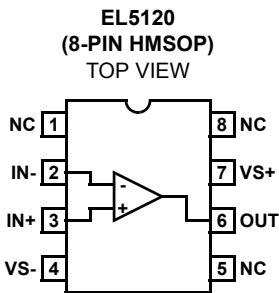
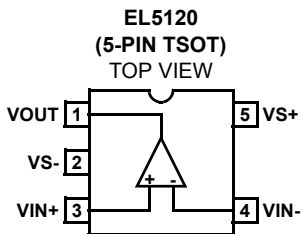

EL5120, EL5220, EL5420

Absolute Maximum Ratings ($T_A = 25^\circ\text{C}$)

Supply Voltage between V_{S+} and V_{S-} +18V	Storage Temperature -65°C to $+150^\circ\text{C}$
Input Voltage $V_{S-} - 0.5\text{V}$, $V_{S+} + 0.5\text{V}$	Ambient Operating Temperature -40°C to $+85^\circ\text{C}$
Maximum Continuous Output Current 30mA	Power Dissipation See Curves
Maximum Die Temperature $+125^\circ\text{C}$	

CAUTION: Stresses above those listed in "Absolute Maximum Ratings" may cause permanent damage to the device. This is a stress only rating and operation of the device at these or any other conditions above those indicated in the operational sections of this specification is not implied.

IMPORTANT NOTE: All parameters having Min/Max specifications are guaranteed. Typ values are for information purposes only. Unless otherwise noted, all tests are at the specified temperature and are pulsed tests, therefore: $T_J = T_C = T_A$

Electrical Specifications $V_{S+} = +5\text{V}$, $V_{S-} = -5\text{V}$, $R_L = 10\text{k}\Omega$ and $C_L = 10\text{pF}$ to 0V , $T_A = 25^\circ\text{C}$, unless otherwise specified.

PARAMETER	DESCRIPTION	CONDITIONS	MIN	TYP	MAX	UNIT
INPUT CHARACTERISTICS						
V_{OS}	Input Offset Voltage	$V_{CM} = 0\text{V}$		2	12	mV
TCV_{OS}	Average Offset Voltage Drift	(Note 1)		5		$\mu\text{V}/^\circ\text{C}$
I_B	Input Bias Current	$V_{CM} = 0\text{V}$		2	50	nA
R_{IN}	Input Impedance			1		$\text{G}\Omega$
C_{IN}	Input Capacitance			1.35		pF
CMIR	Common-Mode Input Range		-5.5		+5.5	V
CMRR	Common-Mode Rejection Ratio	for V_{IN} from -5.5V to $+5.5\text{V}$	50	70		dB
A_{VOL}	Open Loop Gain	$-4.5\text{V} \leq V_{OUT} \leq +4.5\text{V}$	75	95		dB
OUTPUT CHARACTERISTICS						
V_{OL}	Output Swing Low	$I_L = -5\text{mA}$		-4.92	-4.85	V
V_{OH}	Output Swing High	$I_L = 5\text{mA}$	4.85	4.92		V
I_{SC}	Short Circuit Current			± 120		mA
I_{OUT}	Output Current			± 30		mA
POWER SUPPLY PERFORMANCE						
PSRR	Power Supply Rejection Ratio	V_S is moved from $\pm 2.25\text{V}$ to $\pm 7.75\text{V}$	60	80		dB
I_S	Supply Current (Per Amplifier)	No load		500	750	μA
DYNAMIC PERFORMANCE						
SR	Slew Rate (Note 2)	$-4.0\text{V} \leq V_{OUT} \leq +4.0\text{V}$, 20% to 80%		10		$\text{V}/\mu\text{s}$
t_S	Settling to $+0.1\%$ ($A_V = +1$)	($A_V = +1$), $V_O = 2\text{V}$ step		500		ns
BW	-3dB Bandwidth	$R_L = 10\text{k}\Omega$, $C_L = 10\text{pF}$		12		MHz
GBWP	Gain-Bandwidth Product	$R_L = 10\text{k}\Omega$, $C_L = 10\text{pF}$		8		MHz
PM	Phase Margin	$R_L = 10\text{k}\Omega$, $C_L = 10\text{pF}$		50		$^\circ$
CS	Channel Separation	$f = 5\text{MHz}$ (EL5220 & EL5420 only)		75		dB

NOTES:

1. Measured over operating temperature range
2. Slew rate is measured on rising and falling edges

EL5120, EL5220, EL5420

Electrical Specifications $V_{S+} = +5V$, $V_{S-} = 0V$, $R_L = 10k\Omega$ and $C_L = 10pF$ to 2.5V, $T_A = 25^\circ C$, unless otherwise specified.

PARAMETER	DESCRIPTION	CONDITIONS	MIN	TYP	MAX	UNIT
INPUT CHARACTERISTICS						
V_{OS}	Input Offset Voltage	$V_{CM} = 2.5V$		2	10	mV
TCV_{OS}	Average Offset Voltage Drift	(Note 1)		5		$\mu V/^\circ C$
I_B	Input Bias Current	$V_{CM} = 2.5V$		2	50	nA
R_{IN}	Input Impedance			1		$G\Omega$
C_{IN}	Input Capacitance			1.35		pF
CMIR	Common-Mode Input Range		-0.5		+5.5	V
CMRR	Common-Mode Rejection Ratio	for V_{IN} from -0.5V to +5.5V	45	66		dB
A_{VOL}	Open Loop Gain	$0.5V \leq V_{OUT} \leq +4.5V$	75	95		dB
OUTPUT CHARACTERISTICS						
V_{OL}	Output Swing Low	$I_L = -5mA$		80	150	mV
V_{OH}	Output Swing High	$I_L = +5mA$	4.85	4.92		V
I_{SC}	Short Circuit Current			± 120		mA
I_{OUT}	Output Current			± 30		mA
POWER SUPPLY PERFORMANCE						
PSRR	Power Supply Rejection Ratio	V_S is moved from 4.5V to 15.5V	60	80		dB
I_S	Supply Current (Per Amplifier)	No load		500	750	μA
DYNAMIC PERFORMANCE						
SR	Slew Rate (Note 2)	$1V \leq V_{OUT} \leq 4V$, 20% to 80%		10		$V/\mu s$
t_S	Settling to +0.1% ($A_V = +1$)	($A_V = +1$), $V_O = 2V$ step		500		ns
BW	-3dB Bandwidth	$R_L = 10k\Omega$, $C_L = 10pF$		12		MHz
GBWP	Gain-Bandwidth Product	$R_L = 10k\Omega$, $C_L = 10pF$		8		MHz
PM	Phase Margin	$R_L = 10k\Omega$, $C_L = 10pF$		50		$^\circ$
CS	Channel Separation	$f = 5MHz$ (EL5220 & EL5420 only)		75		dB

NOTES:

1. Measured over operating temperature range
2. Slew rate is measured on rising and falling edges

EL5120, EL5220, EL5420

Electrical Specifications $V_{S+} = +15V$, $V_{S-} = 0V$, $R_L = 10k\Omega$ and $C_L = 10pF$ to 7.5V, $T_A = 25^\circ C$, unless otherwise specified.

PARAMETER	DESCRIPTION	CONDITIONS	MIN	TYP	MAX	UNIT
INPUT CHARACTERISTICS						
V_{OS}	Input Offset Voltage	$V_{CM} = 7.5V$		2	14	mV
TCV_{OS}	Average Offset Voltage Drift	(Note 1)		5		$\mu V/^\circ C$
I_B	Input Bias Current	$V_{CM} = 7.5V$		2	50	nA
R_{IN}	Input Impedance			1		$G\Omega$
C_{IN}	Input Capacitance			1.35		pF
CMIR	Common-Mode Input Range		-0.5		+15.5	V
CMRR	Common-Mode Rejection Ratio	for V_{IN} from -0.5V to +15.5V	53	72		dB
A_{VOL}	Open Loop Gain	$0.5V \leq V_{OUT} \leq 14.5V$	75	95		dB
OUTPUT CHARACTERISTICS						
V_{OL}	Output Swing Low	$I_L = -5mA$		80	150	mV
V_{OH}	Output Swing High	$I_L = +5mA$	14.85	14.92		V
I_{SC}	Short Circuit Current			± 120		mA
I_{OUT}	Output Current			± 30		mA
POWER SUPPLY PERFORMANCE						
PSRR	Power Supply Rejection Ratio	V_S is moved from 4.5V to 15.5V	60	80		dB
I_S	Supply Current (Per Amplifier)	No load		500	750	μA
DYNAMIC PERFORMANCE						
SR	Slew Rate (Note 2)	$1V \leq V_{OUT} \leq 14V$, 20% to 80%		10		$V/\mu s$
t_S	Settling to +0.1% ($A_V = +1$)	($A_V = +1$), $V_O = 2V$ step		500		ns
BW	-3dB Bandwidth	$R_L = 10k\Omega$, $C_L = 10pF$		12		MHz
GBWP	Gain-Bandwidth Product	$R_L = 10k\Omega$, $C_L = 10pF$		8		MHz
PM	Phase Margin	$R_L = 10k\Omega$, $C_L = 10 pF$		50		$^\circ$
CS	Channel Separation	$f = 5MHz$ (EL5220 & EL5420 only)		75		dB

NOTES:

1. Measured over operating temperature range
2. Slew rate is measured on rising and falling edges

Typical Performance Curves

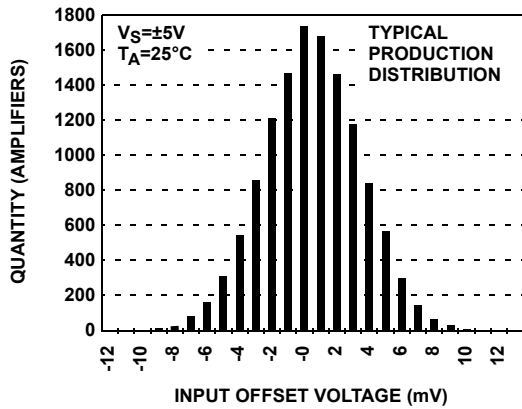

FIGURE 1. EL5420 INPUT OFFSET VOLTAGE DISTRIBUTION

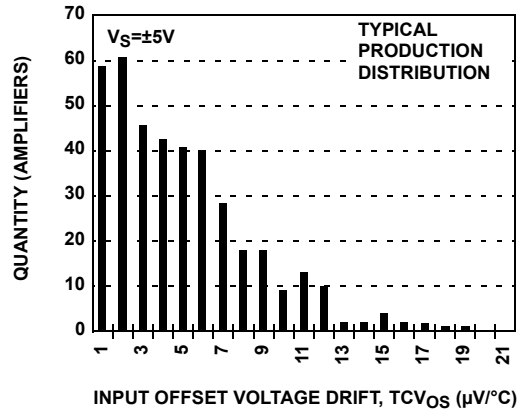

FIGURE 2. EL5420 INPUT OFFSET VOLTAGE DRIFT

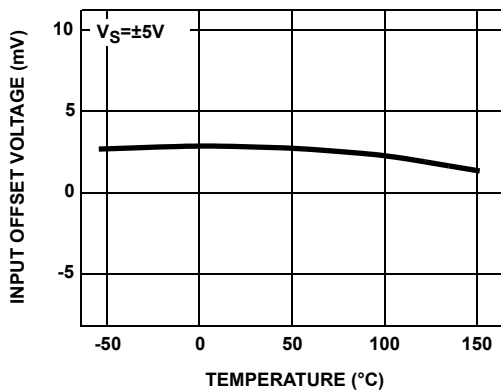

FIGURE 3. INPUT OFFSET VOLTAGE vs TEMPERATURE

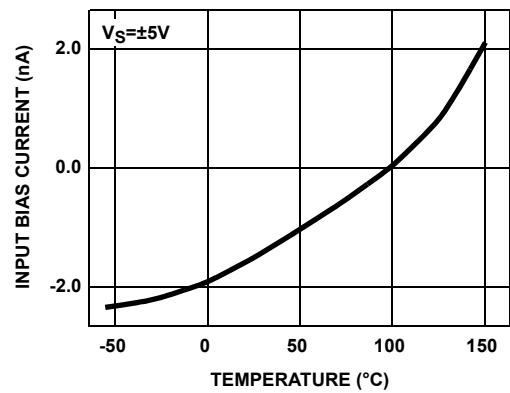

FIGURE 4. INPUT BIAS CURRENT vs TEMPERATURE

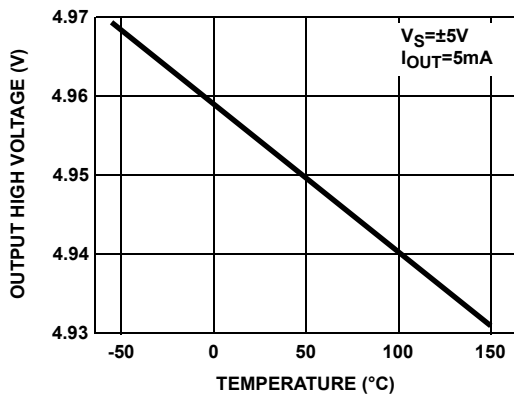

FIGURE 5. OUTPUT HIGH VOLTAGE vs TEMPERATURE

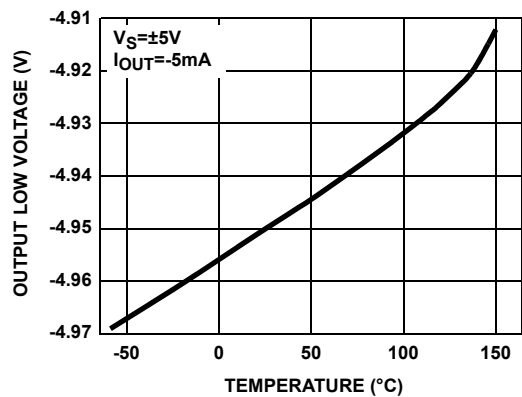

FIGURE 6. OUTPUT LOW VOLTAGE vs TEMPERATURE

Typical Performance Curves (Continued)

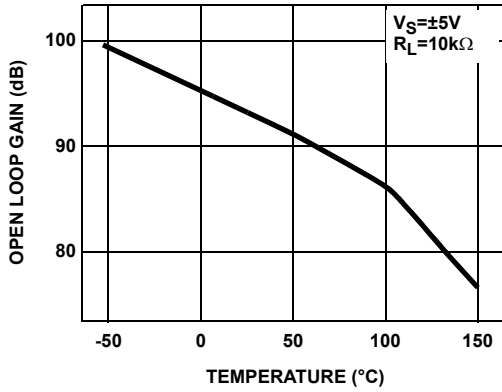

FIGURE 7. OPEN LOOP GAIN vs TEMPERATURE

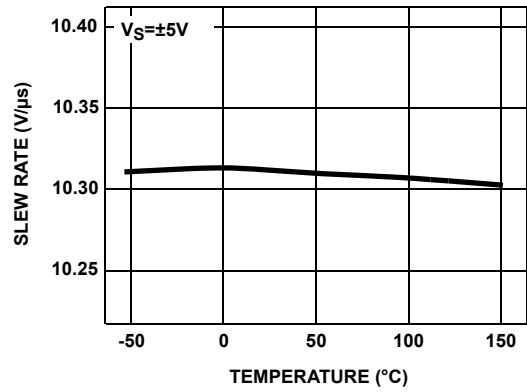

FIGURE 8. SLEW RATE vs TEMPERATURE

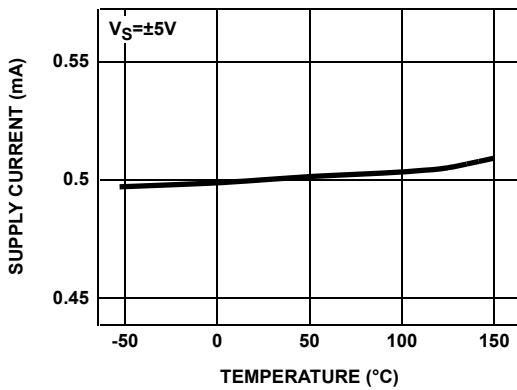

FIGURE 9. EL5420 SUPPLY CURRENT PER AMPLIFIER vs TEMPERATURE

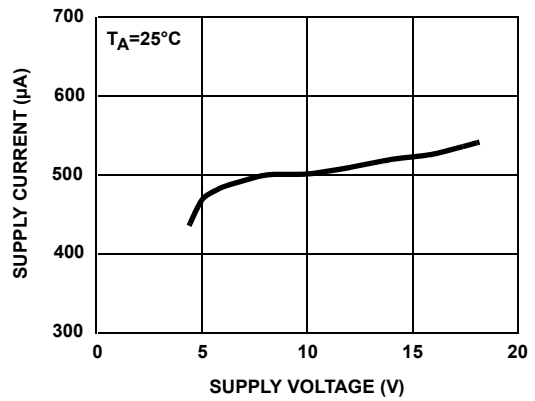

FIGURE 10. EL5420 SUPPLY CURRENT PER AMPLIFIER vs SUPPLY VOLTAGE

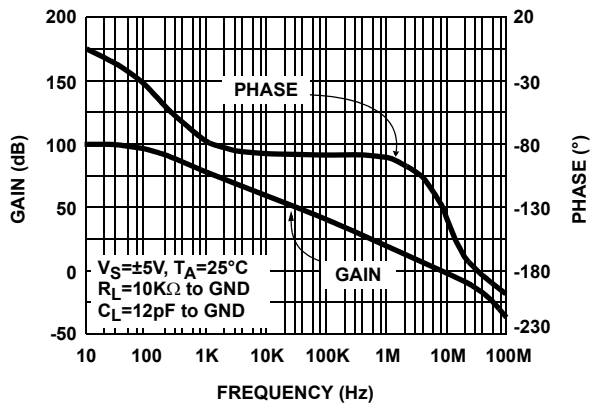

FIGURE 11. OPEN LOOP GAIN AND PHASE vs FREQUENCY

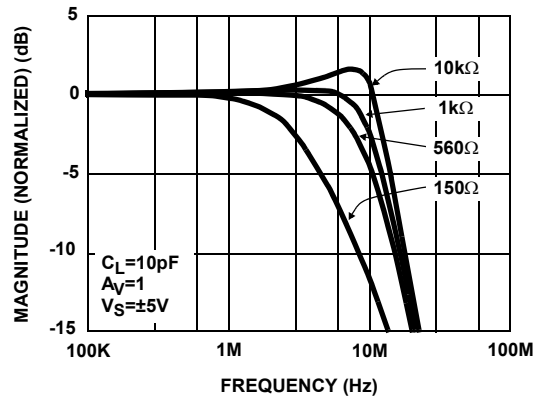

FIGURE 12. FREQUENCY RESPONSE FOR VARIOUS R_L

Typical Performance Curves (Continued)

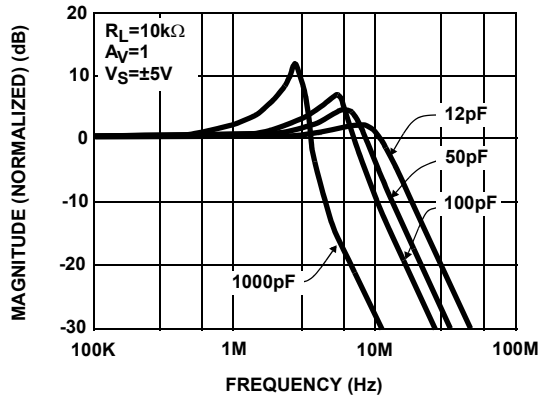

FIGURE 13. FREQUENCY RESPONSE FOR VARIOUS C_L

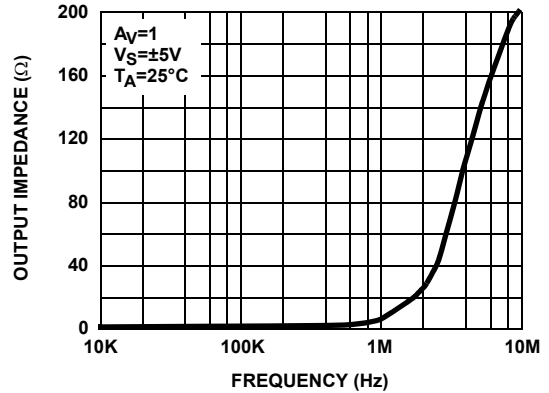

FIGURE 14. CLOSED LOOP OUTPUT IMPEDANCE vs FREQUENCY

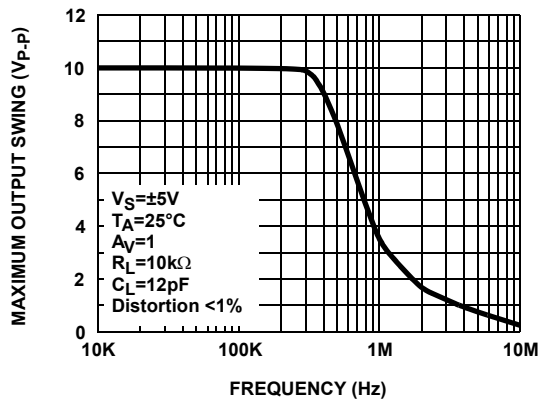

FIGURE 15. MAXIMUM OUTPUT SWING vs FREQUENCY

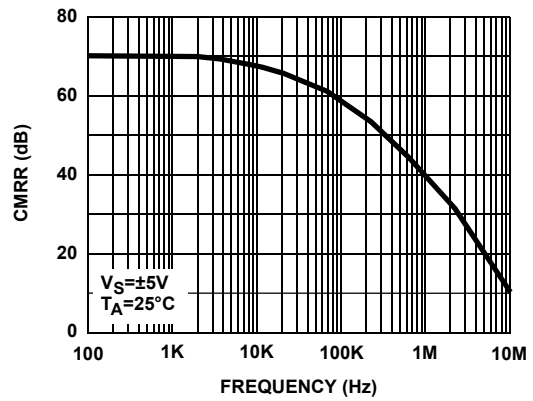

FIGURE 16. CMRR vs FREQUENCY

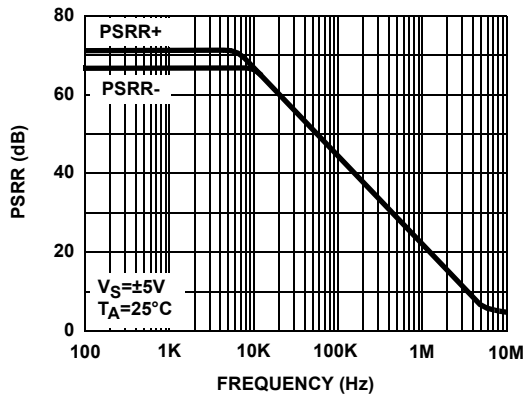

FIGURE 17. PSRR vs FREQUENCY

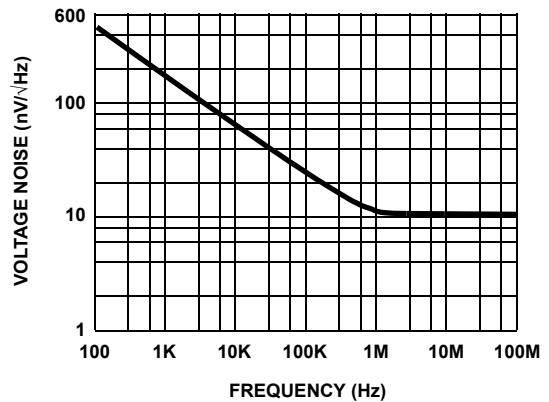

FIGURE 18. INPUT VOLTAGE NOISE SPECTRAL DENSITY vs FREQUENCY

Typical Performance Curves (Continued)

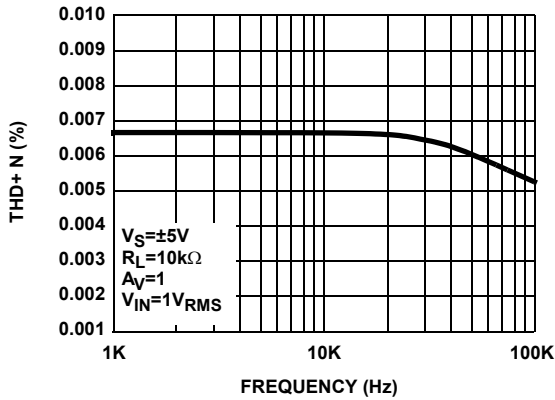

FIGURE 19. TOTAL HARMONIC DISTORTION + NOISE vs FREQUENCY

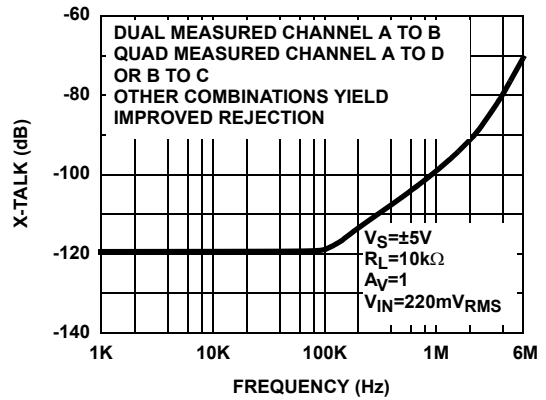

FIGURE 20. CHANNEL SEPARATION vs FREQUENCY RESPONSE

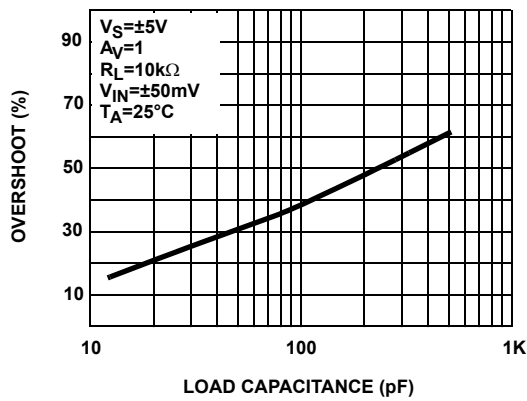

FIGURE 21. SMALL SIGNAL OVERSHOOT vs LOAD CAPACITANCE

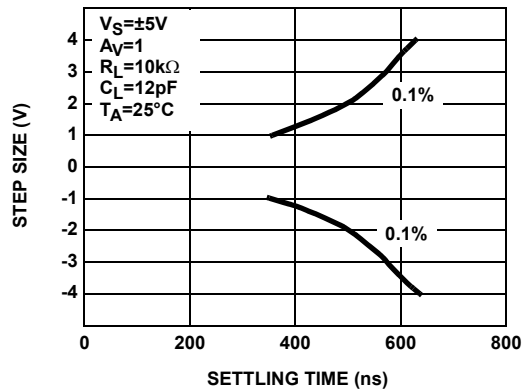

FIGURE 22. SETTLING TIME vs STEP SIZE

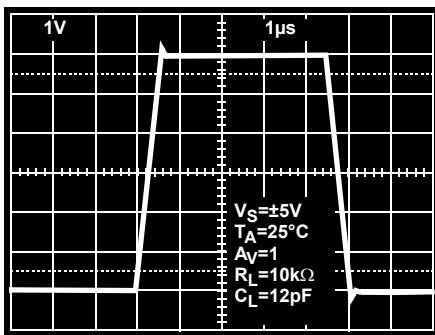

FIGURE 23. LARGE SIGNAL TRANSIENT RESPONSE

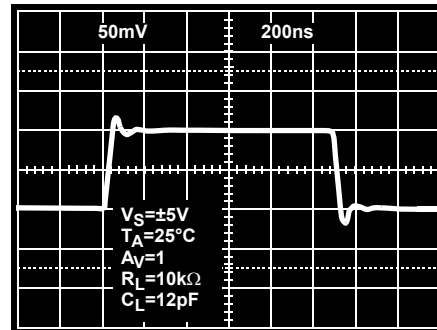
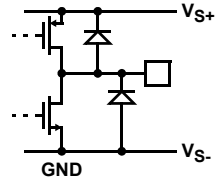
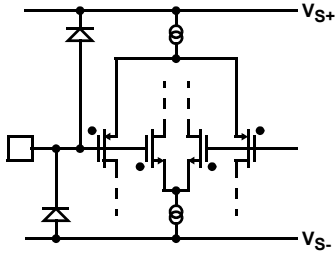

FIGURE 24. SMALL SIGNAL TRANSIENT RESPONSE

Pin Descriptions

EL5120	EL5220	EL5420	PIN NAME	PIN FUNCTION	EQUIVALENT CIRCUIT
1	1	1	VOUTA	Amplifier A Output	 CIRCUIT 1
4	2	2	VINA-	Amplifier A Inverting Input	 CIRCUIT 2
3	3	3	VINA+	Amplifier A Non-Inverting Input	(Reference Circuit 2)
5	8	4	VS+	Positive Power Supply	
	5	5	VINB+	Amplifier B Non-Inverting Input	(Reference Circuit 2)
	6	6	VINB-	Amplifier B Inverting Input	(Reference Circuit 2)
	7	7	VOUTB	Amplifier B Output	(Reference Circuit 1)
		8	VOUTC	Amplifier C Output	(Reference Circuit 1)
		9	VINC-	Amplifier C Inverting Input	(Reference Circuit 2)
		10	VINC+	Amplifier C Non-Inverting Input	(Reference Circuit 2)
2	4	11	VS-	Negative Power Supply	
		12	VIND+	Amplifier D Non-Inverting Input	(Reference Circuit 2)
		13	VIND-	Amplifier D Inverting Input	(Reference Circuit 2)
		14	VOUTD	Amplifier D Output	(Reference Circuit 1)

Applications Information

Product Description

The EL5120, EL5220, and EL5420 voltage feedback amplifiers are fabricated using a high voltage CMOS process. They exhibit rail-to-rail input and output capability, they are unity gain stable, and have low power consumption (500µA per amplifier). These features make the EL5120, EL5220, and EL5420 ideal for a wide range of general-purpose applications. Connected in voltage follower mode and driving a load of 10kΩ and 12pF, the EL5120, EL5220, and EL5420 have a -3dB bandwidth of 12MHz while maintaining a 10V/µs slew rate. The EL5120 is a single amplifier, the EL5220 is a dual amplifier, and the EL5420 is a quad amplifier.

Operating Voltage, Input, and Output

The EL5120, EL5220, and EL5420 are specified with a single nominal supply voltage from 5V to 15V or a split supply with its total range from 5V to 15V. Correct operation is guaranteed for a supply range of 4.5V to 16.5V. Most EL5120, EL5220, and EL5420 specifications are stable over both the full supply range and operating temperatures of -40°C to +85°C. Parameter variations with operating voltage and/or temperature are shown in the typical performance curves.

The input common-mode voltage range of the EL5120, EL5220, and EL5420 extends 500mV beyond the supply rails. The output swings of the EL5120, EL5220, and EL5420 typically extend to within 80mV of positive and negative supply rails with load currents of 5mA. Decreasing load currents will extend the output voltage range even closer to the supply rails. Figure 25 shows the input and

output waveforms for the device in the unity-gain configuration. Operation is from $\pm 5V$ supply with a $10k\Omega$ load connected to GND. The input is a $10V_{P-P}$ sinusoid. The output voltage is approximately $9.985V_{P-P}$.

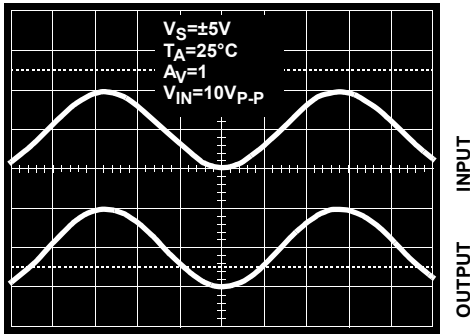

FIGURE 25. OPERATION WITH RAIL-TO-RAIL INPUT AND OUTPUT

Short Circuit Current Limit

The EL5120, EL5220, and EL5420 will limit the short circuit current to $\pm 120mA$ if the output is directly shorted to the positive or the negative supply. If an output is shorted indefinitely, the power dissipation could easily increase such that the device may be damaged. Maximum reliability is maintained if the output continuous current never exceeds $\pm 30mA$. This limit is set by the design of the internal metal interconnects.

Output Phase Reversal

The EL5120, EL5220, and EL5420 are immune to phase reversal as long as the input voltage is limited from $(V_S-) - 0.5V$ to $(V_S+) + 0.5V$. Figure 26 shows a photo of the output of the device with the input voltage driven beyond the supply rails. Although the device's output will not change phase, the input's overvoltage should be avoided. If an input voltage exceeds supply voltage by more than $0.6V$, electrostatic protection diodes placed in the input stage of the device begin to conduct and overvoltage damage could occur.

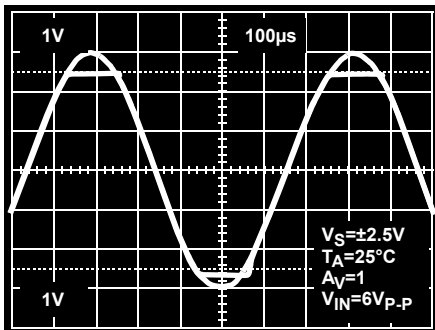

FIGURE 26. OPERATION WITH BEYOND-THE-RAILS INPUT

Power Dissipation

With the high-output drive capability of the EL5120, EL5220, and EL5420 amplifiers, it is possible to exceed the $125^\circ C$ "absolute-maximum junction temperature" under certain load

current conditions. Therefore, it is important to calculate the maximum junction temperature for the application to determine if load conditions need to be modified for the amplifier to remain in the safe operating area.

The maximum power dissipation allowed in a package is determined according to:

$$P_{D_{MAX}} = \frac{T_{J_{MAX}} - T_{A_{MAX}}}{\theta_{JA}}$$

where:

- $T_{J_{MAX}}$ = Maximum junction temperature
- $T_{A_{MAX}}$ = Maximum ambient temperature
- θ_{JA} = Thermal resistance of the package
- $P_{D_{MAX}}$ = Maximum power dissipation in the package

The maximum power dissipation actually produced by an IC is the total quiescent supply current times the total power supply voltage, plus the power in the IC due to the loads, or:

$$P_{D_{MAX}} = \sum i \times [V_S \times I_{S_{MAX}} + (V_S + V_{OUT}^i) \times I_{LOAD}^i]$$

when sourcing, and:

$$P_{D_{MAX}} = \sum i \times [V_S \times I_{S_{MAX}} + (V_{OUT}^i - V_S^-) \times I_{LOAD}^i]$$

when sinking.

where:

- $i = 1$ to 2 for dual and 1 to 4 for quad
- V_S = Total supply voltage
- $I_{S_{MAX}}$ = Maximum supply current per amplifier
- V_{OUT}^i = Maximum output voltage of the application
- I_{LOAD}^i = Load current

If we set the two $P_{D_{MAX}}$ equations equal to each other, we can solve for R_{LOAD}^i to avoid device overheat. Figures 27 and 28 provide a convenient way to see if the device will overheat. The maximum safe power dissipation can be found graphically, based on the package type and the ambient temperature. By using the previous equation, it is a simple matter to see if $P_{D_{MAX}}$ exceeds the device's power derating curves. To ensure proper operation, it is important to observe the recommended derating curves in Figures 27 and 28.

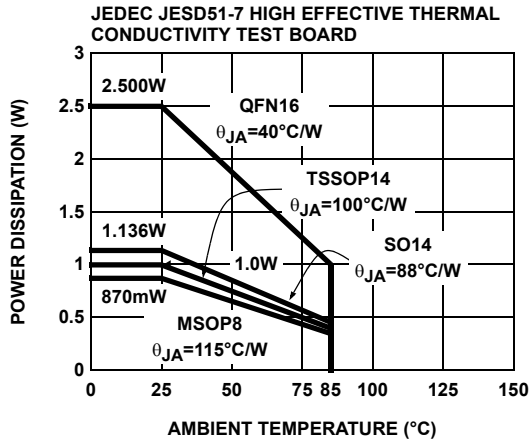

FIGURE 27. PACKAGE POWER DISSIPATION VS AMBIENT TEMPERATURE

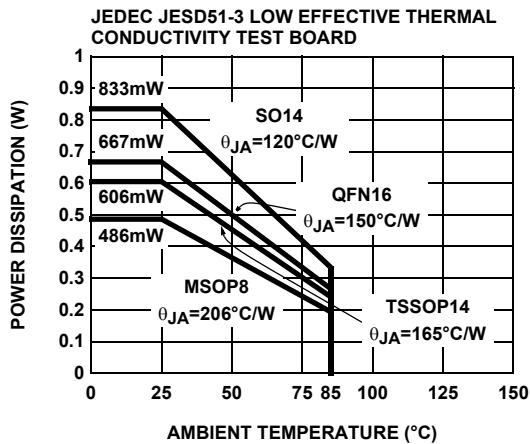

FIGURE 28. PACKAGE POWER DISSIPATION VS AMBIENT TEMPERATURE

Unused Amplifiers

It is recommended that any unused amplifiers in a dual and a quad package be configured as a unity gain follower. The inverting input should be directly connected to the output and the non-inverting input tied to the ground plane.

Driving Capacitive Loads

The EL5120, EL5220, and EL5420 can drive a wide range of capacitive loads. As load capacitance increases, however, the -3dB bandwidth of the device will decrease and the peaking increase. The amplifiers drive 10pF loads in parallel with 10kΩ with just 1.5dB of peaking, and 100pF with 6.4dB of peaking. If less peaking is desired in these applications, a small series resistor (usually between 5Ω and 50Ω) can be placed in series with the output. However, this will obviously reduce the gain slightly. Another method of reducing peaking is to add a “snubber” circuit at the output. A snubber is a shunt load consisting of a resistor in series with a capacitor. Values of 150Ω and 10nF are typical. The advantage of a snubber is that it does not draw any DC load current or reduce the gain

Power Supply Bypassing and Printed Circuit Board Layout

The EL5120, EL5220, and EL5420 can provide gain at high frequency. As with any high-frequency device, good printed circuit board layout is necessary for optimum performance. Ground plane construction is highly recommended, lead lengths should be as short as possible and the power supply pins must be well bypassed to reduce the risk of oscillation. For normal single supply operation, where the VS- pin is connected to ground, a 0.1μF ceramic capacitor should be placed from VS+ to pin to VS- pin. A 4.7μF tantalum capacitor should then be connected in parallel, placed in the region of the amplifier. One 4.7μF capacitor may be used for multiple devices. This same capacitor combination should be placed at each supply pin to ground if split supplies are to be used.

All Intersil U.S. products are manufactured, assembled and tested utilizing ISO9000 quality systems. Intersil Corporation’s quality certifications can be viewed at www.intersil.com/design/quality

Intersil products are sold by description only. Intersil Corporation reserves the right to make changes in circuit design, software and/or specifications at any time without notice. Accordingly, the reader is cautioned to verify that data sheets are current before placing orders. Information furnished by Intersil is believed to be accurate and reliable. However, no responsibility is assumed by Intersil or its subsidiaries for its use; nor for any infringements of patents or other rights of third parties which may result from its use. No license is granted by implication or otherwise under any patent or patent rights of Intersil or its subsidiaries.

For information regarding Intersil Corporation and its products, see www.intersil.com