

1GHz Current Feedback Amplifier with Enable

The EL5191 and EL5191A amplifiers are of the current feedback variety and exhibit a very high bandwidth of 1GHz. This makes these amplifiers ideal for today's high speed video and monitor applications, as well as a number of RF and IF frequency designs.

With a supply current of just 9mA and the ability to run from a single supply voltage from 5V to 10V, these amplifiers offer very high performance for little power consumption.

The EL5191A also incorporates an enable and disable function to reduce the supply current to 100µA typical per amplifier. Allowing the \overline{CE} pin to float or applying a low logic level will enable the amplifier.

The EL5191 is offered in the 5 Ld SOT-23 package and the industry-standard 8 Ld SOIC package. EL5191A is available in the industry-standard 8 Ld SOIC package. Both operate over the industrial temperature range of -40°C to +85°C.

Features.

- 1GHz -3dB bandwidth
- 9mA supply current
- Single and dual supply operation, from 5V to 10V supply span
- Fast enable/disable (EL5191A only)
- Available in SOT-23 packages
- High speed, 600MHz product available (EL5192, EL5292, and EL5392)
- Lower power, 300MHz product available (EL5193, EL5293, EL5393)
- Pb-Free plus anneal available (RoHS compliant)

Applications

- Video amplifiers
- Cable drivers
- RGB amplifiers
- Test equipment
- Instrumentation
- Current to voltage converters

Pinouts

**EL5191A
(8 LD SOIC)
TOP VIEW**

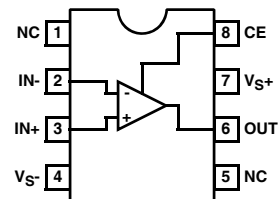

**EL5191
(5 LD SOT-23)
TOP VIEW**

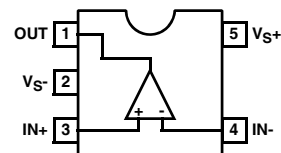

EL5191, EL5191A

Ordering Information

PART NUMBER	PART MARKING	TAPE & REEL	PACKAGE	PKG. DWG. #
EL5191CS	5191CS	-	8 Ld SOIC (150 mil)	MDP0027
EL5191CSZ (Note)	5191CSZ	-	8 Ld SOIC (150 mil) (Pb-free)	MDP0027
EL5191CSZ-T7 (Note)	5191CSZ	7"	8 Ld SOIC (150 mil) (Pb-free)	MDP0027
EL5191CSZ-T13 (Note)	5191CSZ	13"	8 Ld SOIC (150 mil) (Pb-free)	MDP0027
EL5191CW-T7	N	7"	5 Ld SOT-23	MDP0038
EL5191CWZ-T7 (Note)	BAAR	7"	5 Ld SOT-23 (Pb-free)	MDP0038
EL5191ACS	5191ACS	-	8 Ld SOIC (150 mil)	MDP0027
EL5191ACS-T7	5191ACS	7"	8 Ld SOIC (150 mil)	MDP0027
EL5191ACS-T13	5191ACS	13"	8 Ld SOIC (150 mil)	MDP0027
EL5191ACSZ (Note)	5191ACS Z	-	8 Ld SOIC (150 mil) (Pb-free)	MDP0027
EL5191ACSZ-T7 (Note)	5191ACS Z	7"	8 Ld SOIC (150 mil) (Pb-free)	MDP0027
EL5191ACSZ-T13 (Note)	5191ACS Z	13"	8 Ld SOIC (150 mil) (Pb-free)	MDP0027

NOTE: Intersil Pb-free plus anneal products employ special Pb-free material sets; molding compounds/die attach materials and 100% matte tin plate termination finish, which are RoHS compliant and compatible with both SnPb and Pb-free soldering operations. Intersil Pb-free products are MSL classified at Pb-free peak reflow temperatures that meet or exceed the Pb-free requirements of IPC/JEDEC J STD-020.

EL5191, EL5191A

Absolute Maximum Ratings ($T_A = +25^\circ\text{C}$)

Supply Voltage between V_{S+} and V_{S-} 11V
 Pin Voltages $V_{S-} -0.5\text{V}$ to $V_{S+} +0.5\text{V}$
 Maximum Continuous Output Current 50mA

Thermal Information

Power Dissipation See Curves
 Storage Temperature -65°C to $+150^\circ\text{C}$
 Ambient Operating Temperature -40°C to $+85^\circ\text{C}$
 Pb-free reflow profile see link below
<http://www.intersil.com/pbfree/Pb-FreeReflow.asp>

CAUTION: Stresses above those listed in "Absolute Maximum Ratings" may cause permanent damage to the device. This is a stress only rating and operation of the device at these or any other conditions above those indicated in the operational sections of this specification is not implied.

IMPORTANT NOTE: All parameters having Min/Max specifications are guaranteed. Typical values are for information purposes only. Unless otherwise noted, all tests are at the specified temperature and are pulsed tests, therefore: $T_J = T_C = T_A$

Electrical Specifications $V_{S+} = +5\text{V}$, $V_{S-} = -5\text{V}$, $R_F = 392\Omega$ for $A_V = 1$, $R_F = 250\Omega$ for $A_V = 2$, $R_L = 150\Omega$, $T_A = +25^\circ\text{C}$ Unless Otherwise Specified.

PARAMETER	DESCRIPTION	CONDITIONS	MIN	TYP	MAX	UNIT
AC PERFORMANCE						
BW	-3dB Bandwidth	$A_V = +1$		1000		MHz
		$A_V = +2$		600		MHz
BW1	0.1dB Bandwidth			30		MHz
SR	Slew Rate	$V_O = -2.5\text{V}$ to $+2.5\text{V}$, $A_V = +2$	2400	2800		V/ μs
t_S	0.1% Settling Time	$V_{OUT} = -2.5\text{V}$ to $+2.5\text{V}$, $A_V = -1$		7		ns
e_N	Input Voltage Noise			3.8		nV/ $\sqrt{\text{Hz}}$
i_{N-}	IN- Input Current Noise			25		pA/ $\sqrt{\text{Hz}}$
i_{N+}	IN+ Input Current Noise			55		pA/ $\sqrt{\text{Hz}}$
dG	Differential Gain Error (Note 1)	$A_V = +2$		0.035		%
dP	Differential Phase Error (Note 1)	$A_V = +2$		0.04		$^\circ$
DC PERFORMANCE						
V_{OS}	Offset Voltage		-15	1	15	mV
$T_C V_{OS}$	Input Offset Voltage Temperature Coefficient	Measured from T_{MIN} to T_{MAX}		5		$\mu\text{V}/^\circ\text{C}$
R_{OL}	Transimpedance		150	300		k Ω
INPUT CHARACTERISTICS						
CMIR	Common Mode Input Range		± 3	± 3.3		V
CMRR	Common Mode Rejection Ratio		42	50		dB
-ICMR	- Input Current Common Mode Rejection		-6		6	$\mu\text{A}/\text{V}$
$+I_{IN}$	+ Input Current		-120	40	120	μA
$-I_{IN}$	- Input Current		-60	5	60	μA
R_{IN}	Input Resistance			27		k Ω
C_{IN}	Input Capacitance			0.5		pF
OUTPUT CHARACTERISTICS						
V_O	Output Voltage Swing	$R_L = 150\Omega$ to GND	± 3.4	± 3.7		V
		$R_L = 1\text{k}\Omega$ to GND	± 3.8	± 4.0		V
I_{OUT}	Output Current	$R_L = 10\Omega$ to GND	95	120		mA
SUPPLY						
I_{SON}	Supply Current - Enabled	No load, $V_{IN} = 0\text{V}$	8	9	11	mA
I_{SOFF}	Supply Current - Disabled	No load, $V_{IN} = 0\text{V}$		100	150	μA

EL5191, EL5191A

Electrical Specifications $V_{S+} = +5V$, $V_{S-} = -5V$, $R_F = 392\Omega$ for $A_V = 1$, $R_F = 250\Omega$ for $A_V = 2$, $R_L = 150\Omega$, $T_A = +25^\circ C$ Unless Otherwise Specified. **(Continued)**

PARAMETER	DESCRIPTION	CONDITIONS	MIN	TYP	MAX	UNIT
PSRR	Power Supply Rejection Ratio	DC, $V_S = \pm 4.75V$ to $\pm 5.25V$	55	75		dB
-IPSR	- Input Current Power Supply Rejection	DC, $V_S = \pm 4.75V$ to $\pm 5.25V$	-2		2	$\mu A/V$
ENABLE (EL5191A ONLY)						
t_{EN}	Enable Time			40		ns
t_{DIS}	Disable Time			600		ns
I_{IHCE}	CE Pin Input High Current	$\overline{CE} = V_{S+}$		0.8	6	μA
I_{ILCE}	CE Pin Input Low Current	$\overline{CE} = V_{S-}$		0	-0.1	μA
V_{IHCE}	CE Input High Voltage for Power-down		$V_{S+} - 1$			V
V_{ILCE}	CE Input Low Voltage for Power-down				$V_{S+} - 3$	V

NOTE:

- Standard NTSC test, AC signal amplitude = 286mV_{p-p}, f = 3.58MHz

Typical Performance Curves

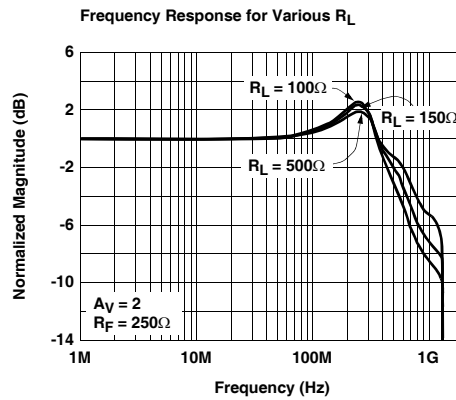
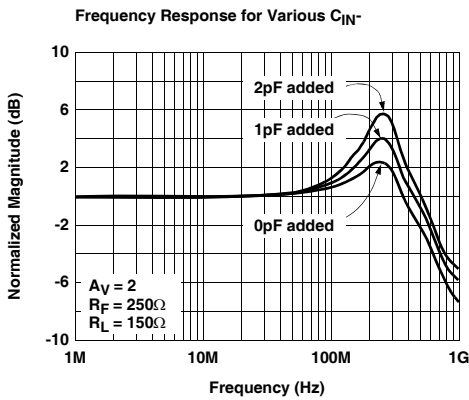
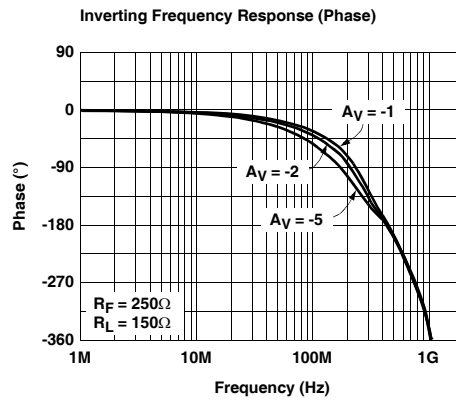
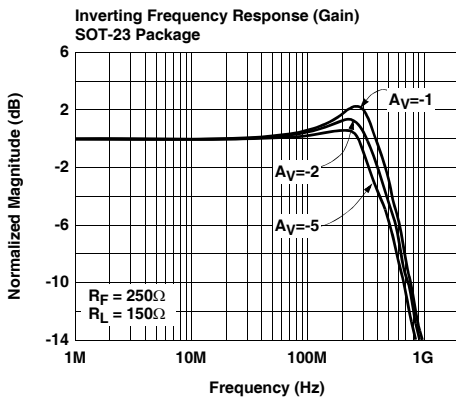
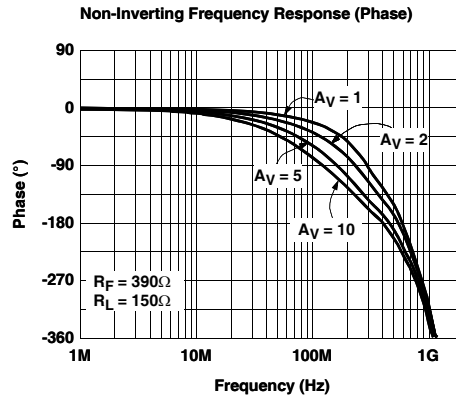
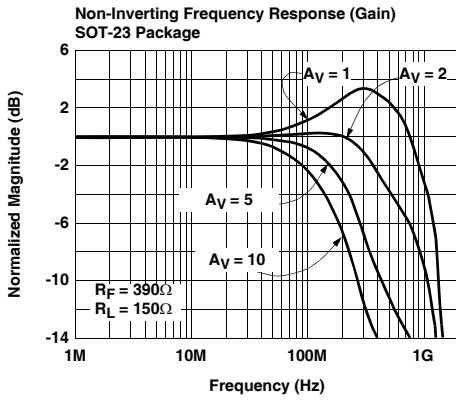

Typical Performance Curves (Continued)

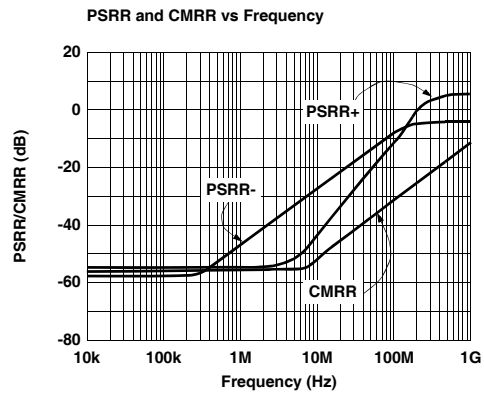
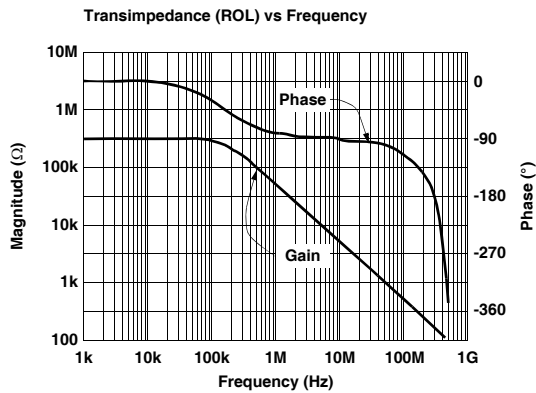
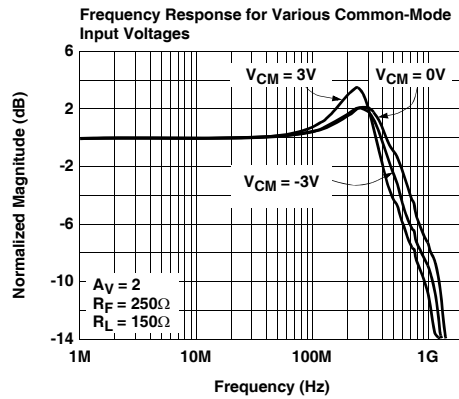
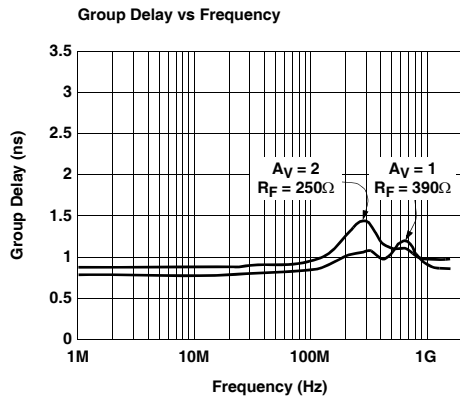
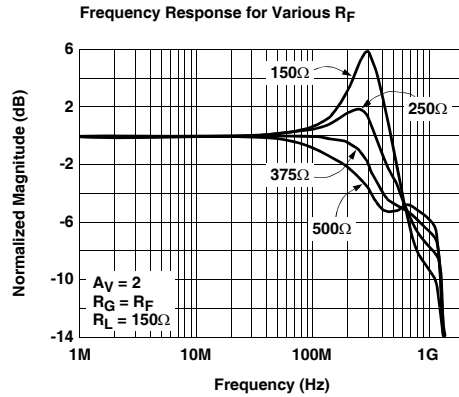
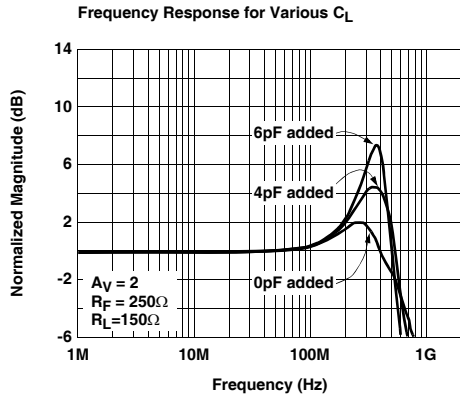

Typical Performance Curves (Continued)

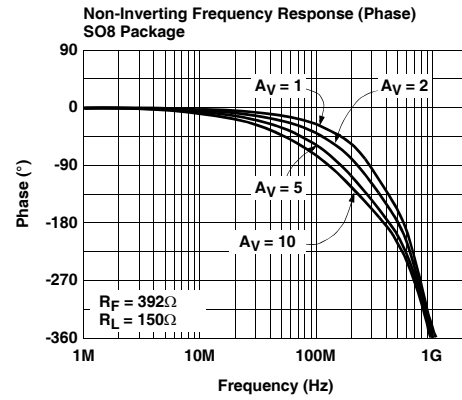
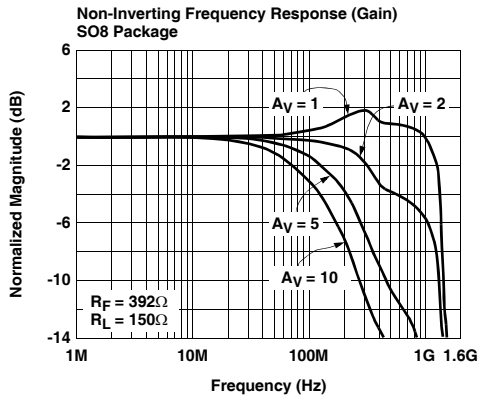
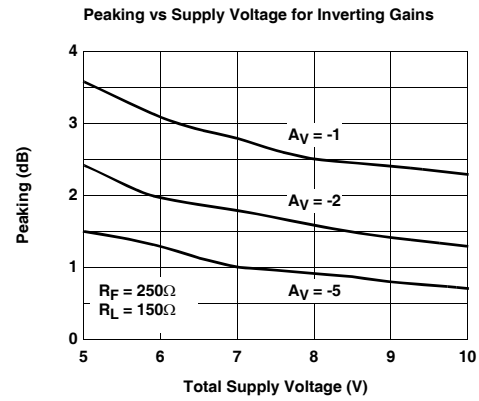
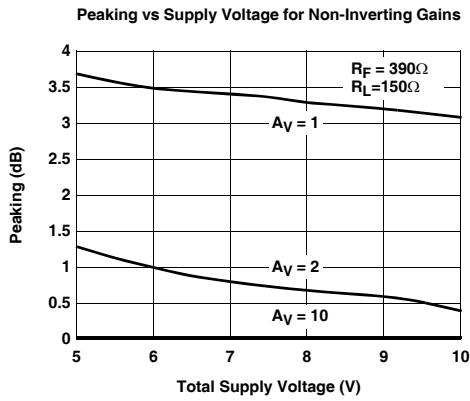
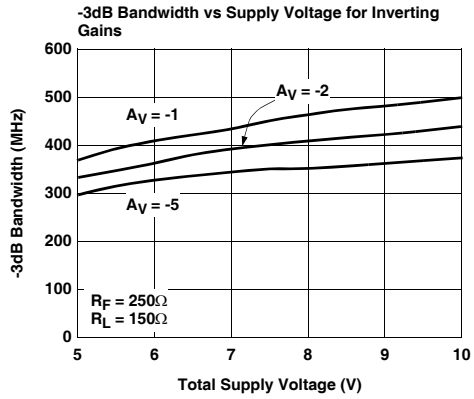
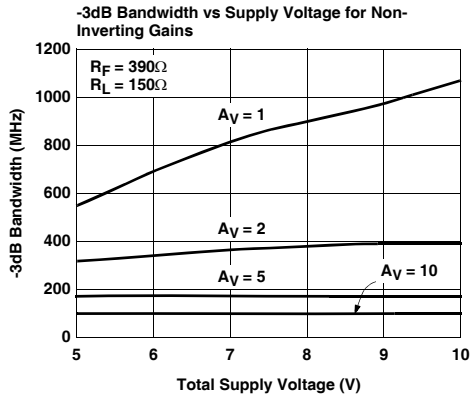

Typical Performance Curves (Continued)

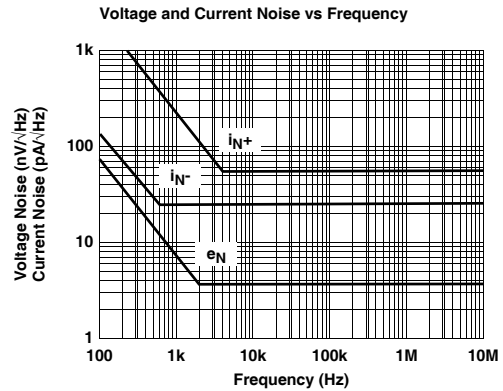
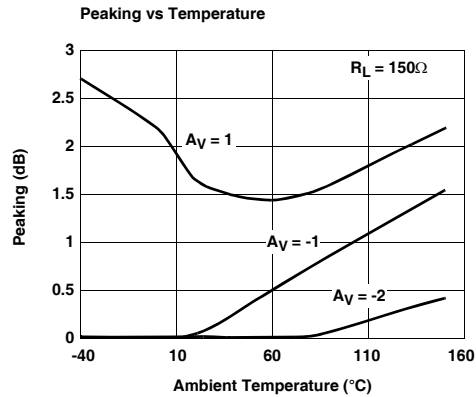
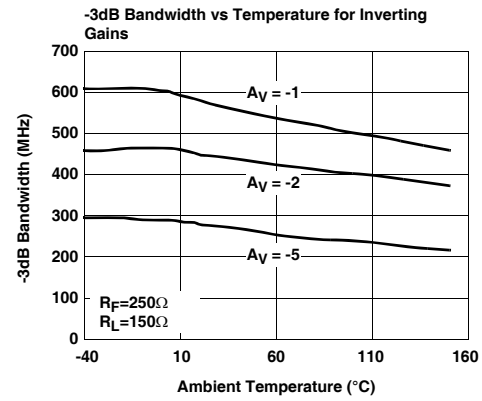
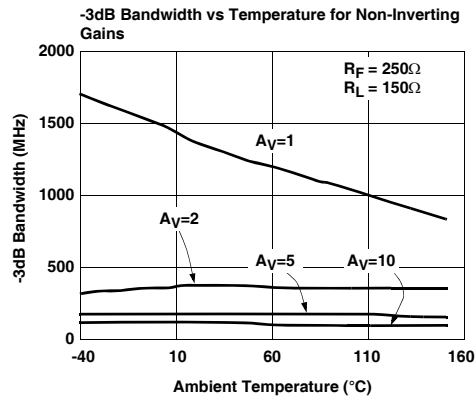
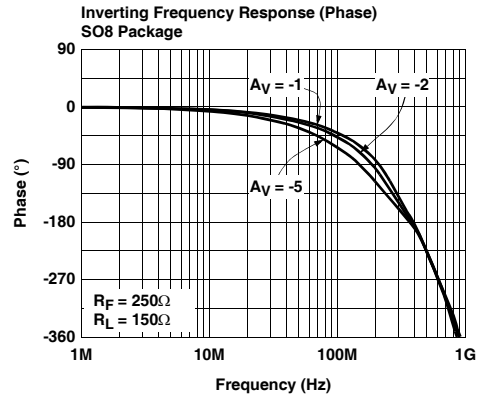
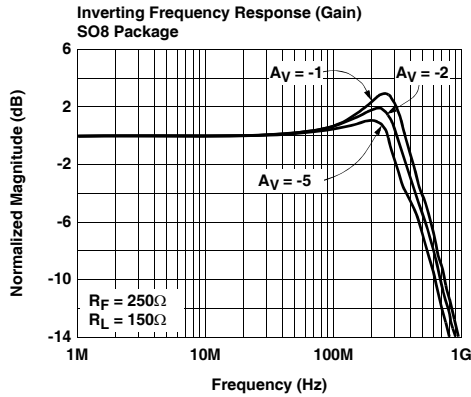

Typical Performance Curves (Continued)

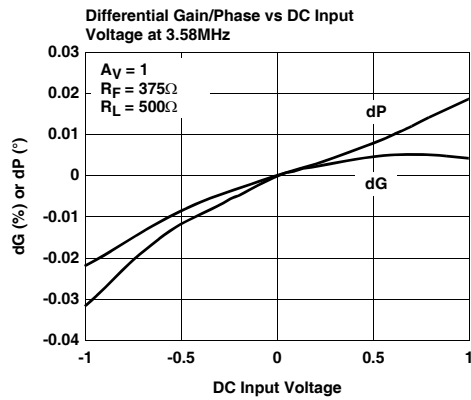
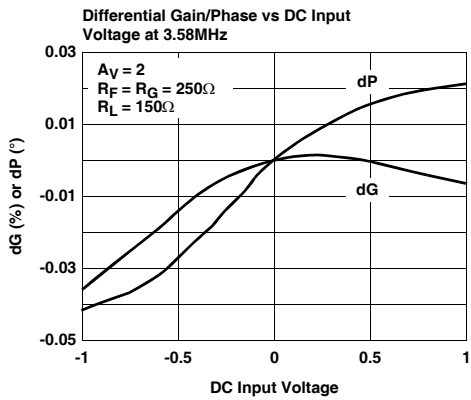
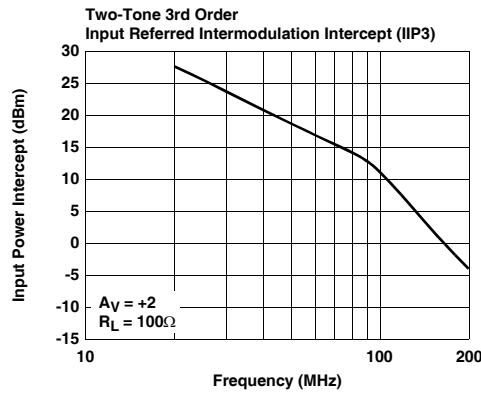
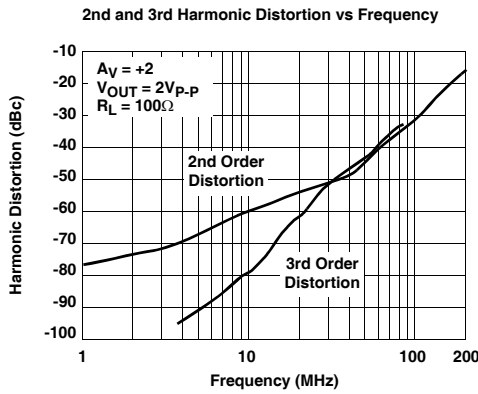
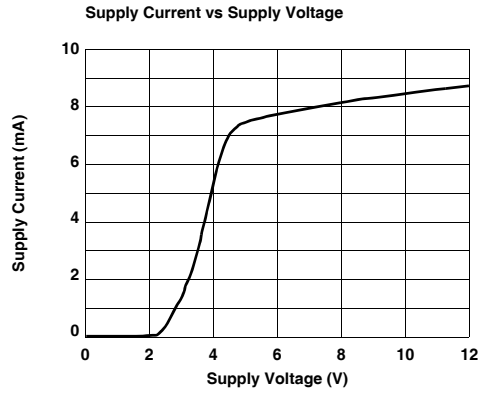
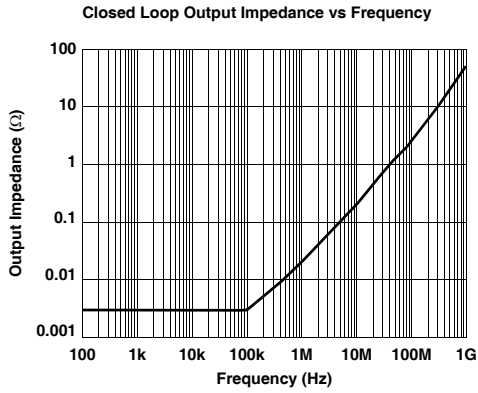

Typical Performance Curves (Continued)

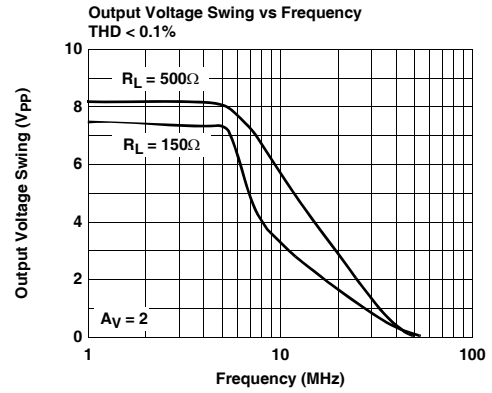
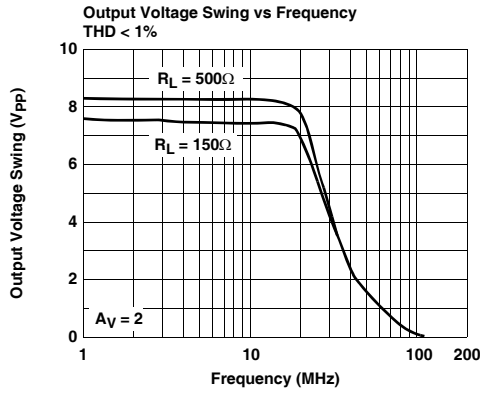

Small Signal Step Response

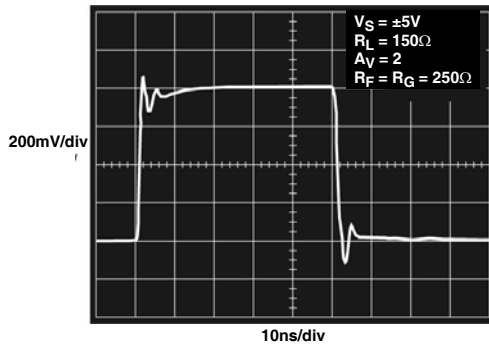

Large Signal Step Response

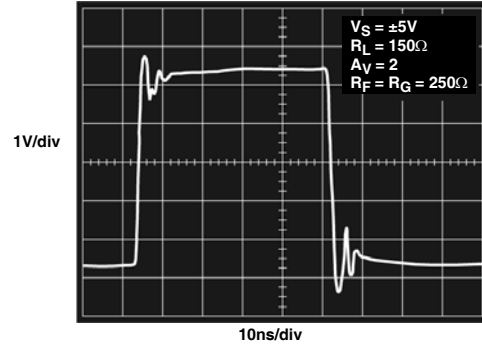

Settling Time vs Settling Accuracy

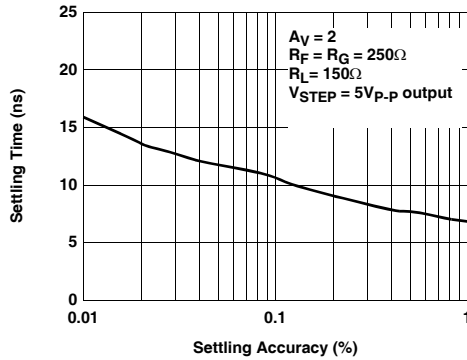

Transimpedance (RoI) Vs Temperature

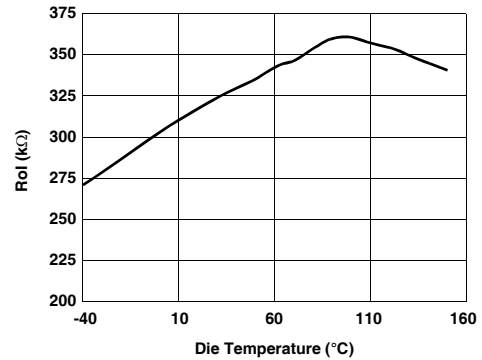

Typical Performance Curves (Continued)

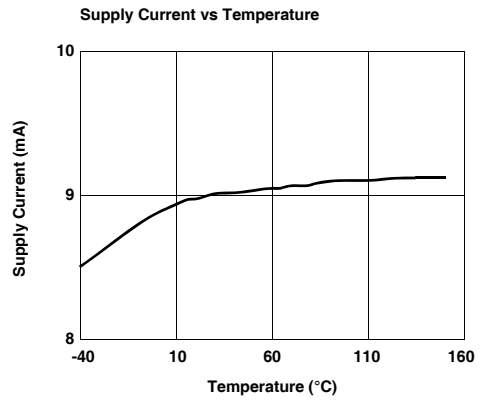
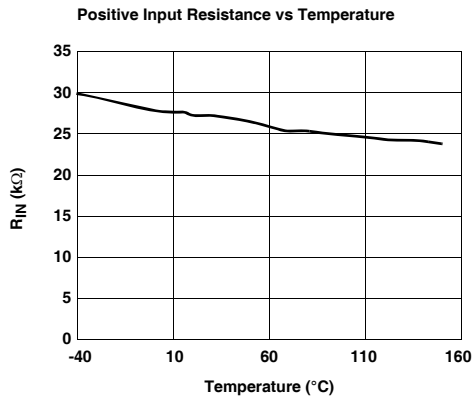
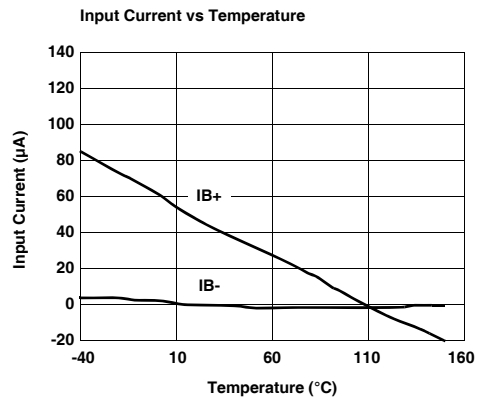
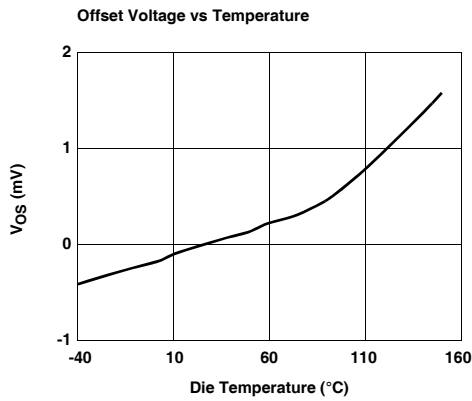
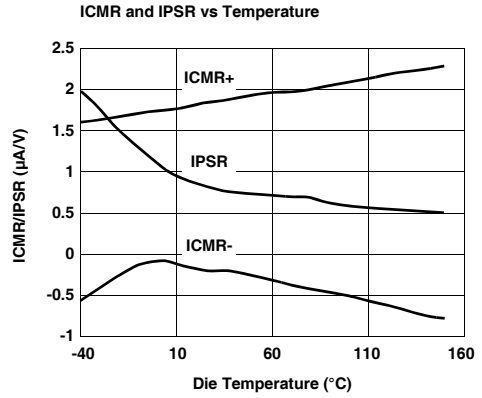
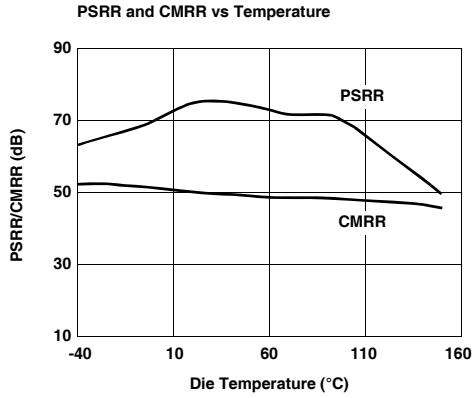

Typical Performance Curves (Continued)

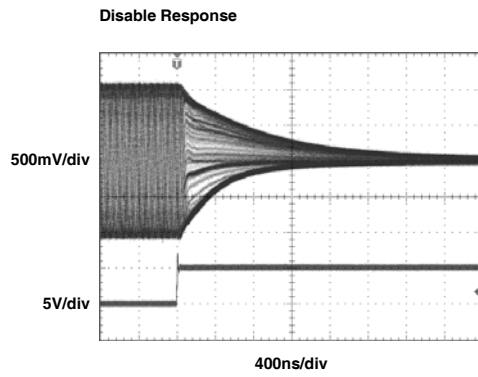
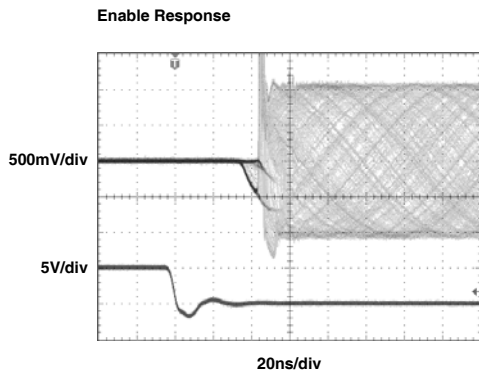
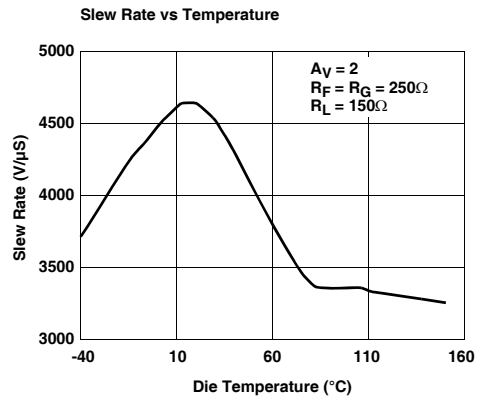
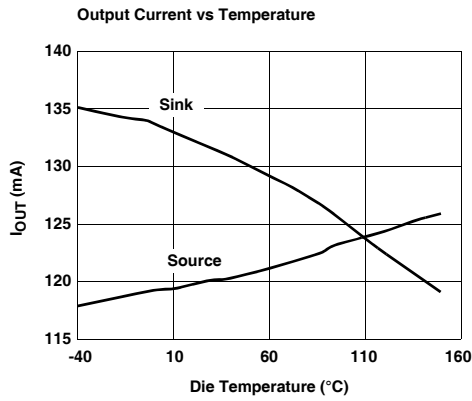
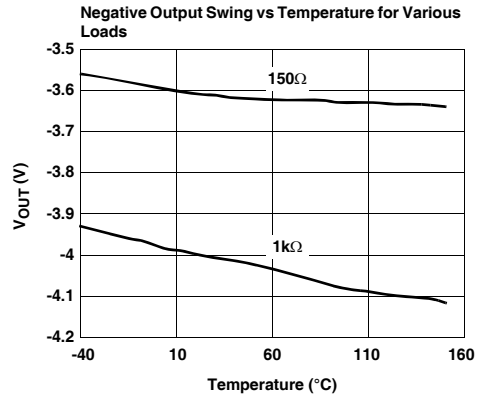
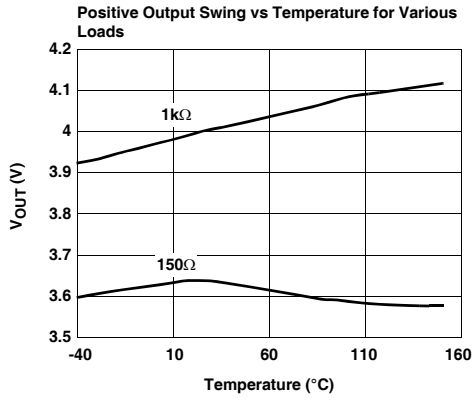

Typical Performance Curves (Continued)

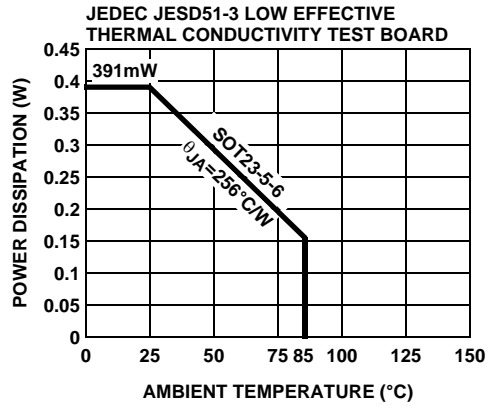
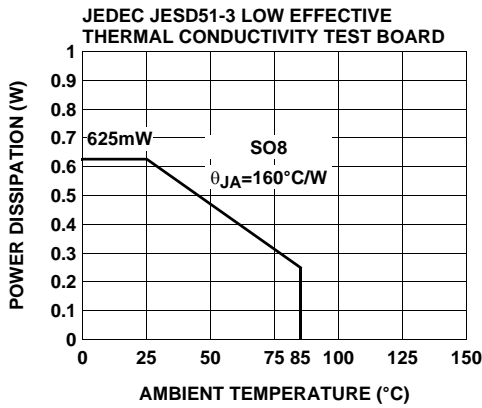
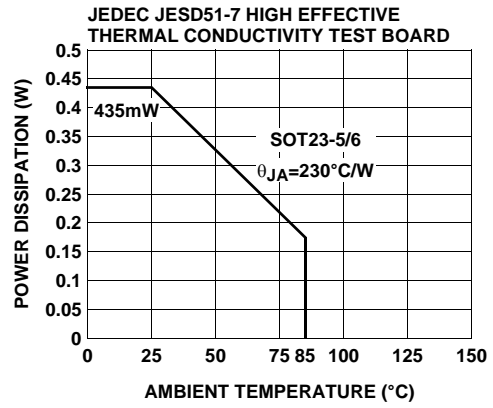
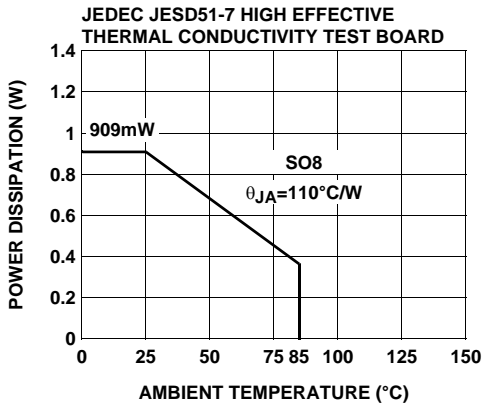

Pin Descriptions

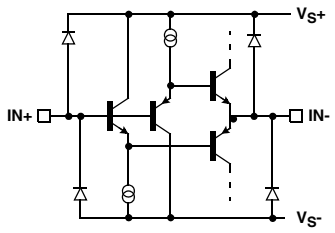
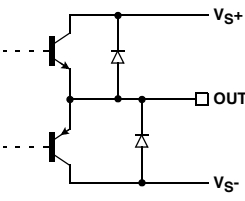
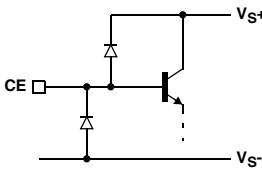
8 Ld SOIC	5 Ld SOT-23	PIN NAME	FUNCTION	EQUIVALENT CIRCUIT
1, 5		NC	Not connected	
2	4	IN-	Inverting input	 <p>Circuit 1</p>
3	3	IN+	Non-inverting input	(See circuit 1)
4	2	VS-	Negative supply	
6	1	OUT	Output	 <p>Circuit 2</p>
7	5	VS+	Positive supply	
8		$\overline{\text{CE}}$	Chip enable	 <p>Circuit 3</p>

Applications Information

Product Description

The EL5191 is a current-feedback operational amplifier that offers a wide -3dB bandwidth of 1GHz and a low supply current of 9mA per amplifier. The EL5191 works with supply voltages ranging from a single 5V to 10V and they are also capable of swinging to within 1V of either supply on the output. Because of their current-feedback topology, the EL5191 does not have the normal gain-bandwidth product associated with voltage-feedback operational amplifiers. Instead, its -3dB bandwidth to remain relatively constant as closed-loop gain is increased. This combination of high bandwidth and low power, together with aggressive pricing make the EL5191 the ideal choice for many low-power/high-bandwidth applications such as portable, handheld, or battery-powered equipment.

For varying bandwidth needs, consider the EL5192 with 600MHz on a 6mA supply current or the EL5193 with 300MHz on a 4mA supply current. Versions include single, dual, and triple amp packages with 5 Ld SOT-23, 16 Ld QSOP, and 8 Ld or 16 Ld SOIC outlines.

Power Supply Bypassing and Printed Circuit Board Layout

As with any high frequency device, good printed circuit board layout is necessary for optimum performance. Low impedance ground plane construction is essential. Surface mount components are recommended, but if leaded components are used, lead lengths should be as short as possible. The power supply pins must be well bypassed to reduce the risk of oscillation. The combination of a 4.7 μ F tantalum capacitor in parallel with a 0.01 μ F capacitor has been shown to work well when placed at each supply pin.

For good AC performance, parasitic capacitance should be kept to a minimum, especially at the inverting input. (See "Capacitance at the Inverting Input" on page 15.) Even when ground plane construction is used, it should be removed from the area near the inverting input to minimize any stray capacitance at that node. Carbon or Metal-Film resistors are acceptable with the Metal-Film resistors giving slightly less peaking and bandwidth because of additional series inductance. Use of sockets, particularly for the SOIC package, should be avoided if possible. Sockets add parasitic inductance and capacitance which will result in additional peaking and overshoot.

Disable/Power-Down

The EL5191A amplifier can be disabled placing its output in a high impedance state. When disabled, the amplifier supply current is reduced to < 150 μ A. The EL5191A is disabled when its $\overline{\text{CE}}$ pin is pulled up to within 1V of the positive supply. Similarly, the amplifier is enabled by floating or pulling its $\overline{\text{CE}}$ pin to at least 3V below the positive supply. For ± 5 V supply, this means that an EL5191A amplifier will be

enabled when $\overline{\text{CE}}$ is 2V or less, and disabled when $\overline{\text{CE}}$ is above 4V. Although the logic levels are not standard TTL, this choice of logic voltages allows the EL5191A to be enabled by tying $\overline{\text{CE}}$ to ground, even in 5V single supply applications. The $\overline{\text{CE}}$ pin can be driven from CMOS outputs.

Capacitance at the Inverting Input

Any manufacturer's high-speed voltage- or current-feedback amplifier can be affected by stray capacitance at the inverting input. For inverting gains, this parasitic capacitance has little effect because the inverting input is a virtual ground. But for non-inverting gains, this capacitance (in conjunction with the feedback and gain resistors) creates a pole in the feedback path of the amplifier. This pole, if low enough in frequency, has the same destabilizing effect as a zero in the forward open-loop response. The use of large value feedback and gain resistors exacerbates the problem by further lowering the pole frequency (increasing the possibility of oscillation.)

The EL5191 has been optimized with a 250 Ω feedback resistor. With the high bandwidth of these amplifiers, these resistor values might cause stability problems when combined with parasitic capacitance, thus ground plane is not recommended around the inverting input pin of the amplifier.

Feedback Resistor Values

The EL5191 has been designed and specified at a gain of +2 with R_F approximately 250 Ω . This value of feedback resistor gives 600MHz of -3dB bandwidth at $A_V = 2$ with about 2dB of peaking. With $A_V = -2$, that same R_F gives 450MHz of bandwidth with 0.6dB of peaking. Since the EL5191 is a current-feedback amplifier, it is also possible to change the value of R_F to get more bandwidth. As seen in the curve of Frequency Response for Various R_F and R_G , bandwidth and peaking can be easily modified by varying the value of the feedback resistor.

Because the EL5191 is a current-feedback amplifier, its gain-bandwidth product is not a constant for different closed-loop gains. This feature actually allows the EL5191 to maintain about the same -3dB bandwidth. As gain is increased, bandwidth decreases slightly while stability increases. Since the loop stability is improving with higher closed-loop gains, it becomes possible to reduce the value of R_F below the specified 250 Ω and still retain stability, resulting in only a slight loss of bandwidth with increased closed-loop gain.

Supply Voltage Range and Single-Supply Operation

The EL5191 has been designed to operate with supply voltages having a span of greater than 5V and less than 10V. In practical terms, this means that the EL5191 will operate on dual supplies ranging from ± 2.5 V to ± 5 V. With single-supply, the EL5191 will operate from 5V to 10V.

As supply voltages continue to decrease, it becomes necessary to provide input and output voltage ranges that can get as close as possible to the supply voltages. The EL5191 has an input range which extends to within 2V of either supply. So, for example, on $\pm 5V$ supplies, the EL5191 has an input range which spans $\pm 3V$. The output range of the EL5191 is also quite large, extending to within 1V of the supply rail. On a $\pm 5V$ supply, the output is therefore capable of swinging from -4V to +4V. Single-supply output range is larger because of the increased negative swing due to the external pull-down resistor to ground.

Video Performance

For good video performance, an amplifier is required to maintain the same output impedance and the same frequency response as DC levels are changed at the output. This is especially difficult when driving a standard video load of 150Ω , because of the change in output current with DC level. Previously, good differential gain could only be achieved by running high idle currents through the output transistors (to reduce variations in output impedance.) These currents were typically comparable to the entire 9mA supply current of each EL5191 amplifier. Special circuitry has been incorporated in the EL5191 to reduce the variation of output impedance with current output. This results in dG and dP specifications of 0.035% and 0.04° , while driving 150Ω at a gain of 2.

Video performance has also been measured with a 500Ω load at a gain of +1. Under these conditions, the EL5191 has dG and dP specifications of 0.02% and 0.02° , respectively.

Output Drive Capability

In spite of its low 9mA of supply current, the EL5191 is capable of providing a minimum of $\pm 95mA$ of output current. With a minimum of $\pm 95mA$ of output drive, the EL5191 is capable of driving 50Ω loads to both rails, making it an excellent choice for driving isolation transformers in telecommunications applications.

Driving Cables and Capacitive Loads

When used as a cable driver, double termination is always recommended for reflection-free performance. For those applications, the back-termination series resistor will decouple the EL5191 from the cable and allow extensive capacitive drive. However, other applications may have high capacitive loads without a back-termination resistor. In these applications, a small series resistor (usually between 5Ω and 50Ω) can be placed in series with the output to eliminate most peaking. The gain resistor (R_G) can then be chosen to make up for any gain loss which may be created by this additional resistor at the output. In many cases it is also possible to simply increase the value of the feedback resistor (R_F) to reduce the peaking.

Current Limiting

The EL5191 has no internal current-limiting circuitry. If the output is shorted, it is possible to exceed the Absolute Maximum Rating for output current or power dissipation, potentially resulting in the destruction of the device.

Power Dissipation

With the high output drive capability of the EL5191, it is possible to exceed the $+125^\circ C$ Absolute Maximum junction temperature under certain very high load current conditions. Generally speaking when R_L falls below about 25Ω , it is important to calculate the maximum junction temperature (T_{JMAX}) for the application to determine if power supply voltages, load conditions, or package type need to be modified for the EL5191 to remain in the safe operating area. These parameters are calculated as follows:

$$T_{JMAX} = T_{MAX} + (\theta_{JA} \times n \times PD_{MAX})$$

where:

T_{MAX} = Maximum ambient temperature

θ_{JA} = Thermal resistance of the package

n = Number of amplifiers in the package

PD_{MAX} = Maximum power dissipation of each amplifier in the package

PD_{MAX} for each amplifier can be calculated as follows:

$$PD_{MAX} = (2 \times V_S \times I_{SMAX}) + \left[(V_S - V_{OUTMAX}) \times \frac{V_{OUTMAX}}{R_L} \right]$$

where:

V_S = Supply voltage

I_{SMAX} = Maximum supply current of 1A

V_{OUTMAX} = Maximum output voltage (required)

R_L = Load resistance

Typical Application Circuits

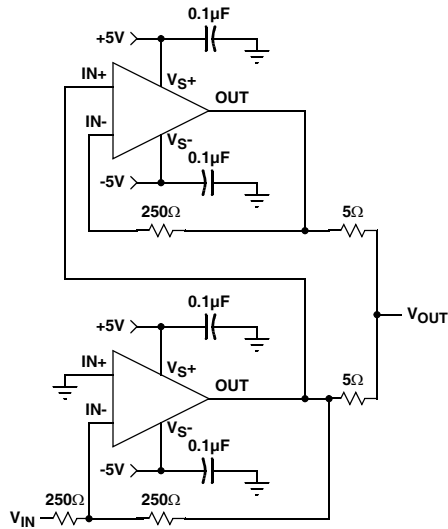

INVERTING 200mA OUTPUT CURRENT DISTRIBUTION AMPLIFIER

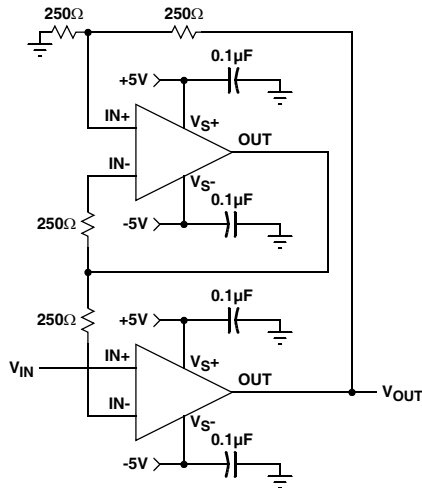

FAST-SETTLING PRECISION AMPLIFIER

Typical Application Circuits (Continued)

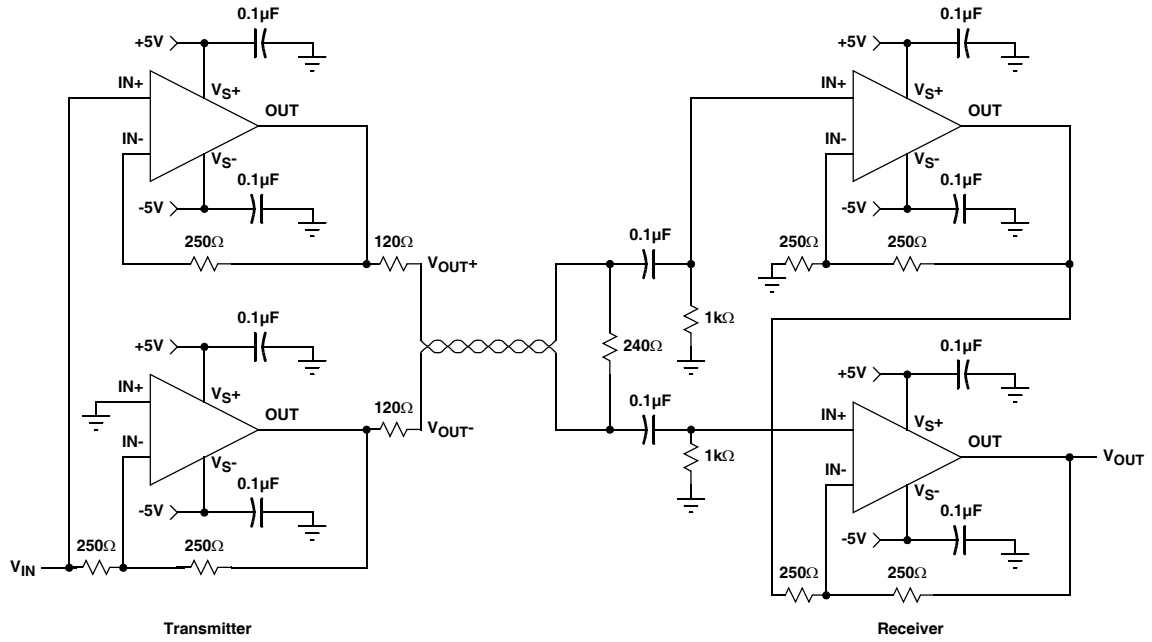

DIFFERENTIAL LINE DRIVER/RECEIVER

Small Outline Package Family (SO)

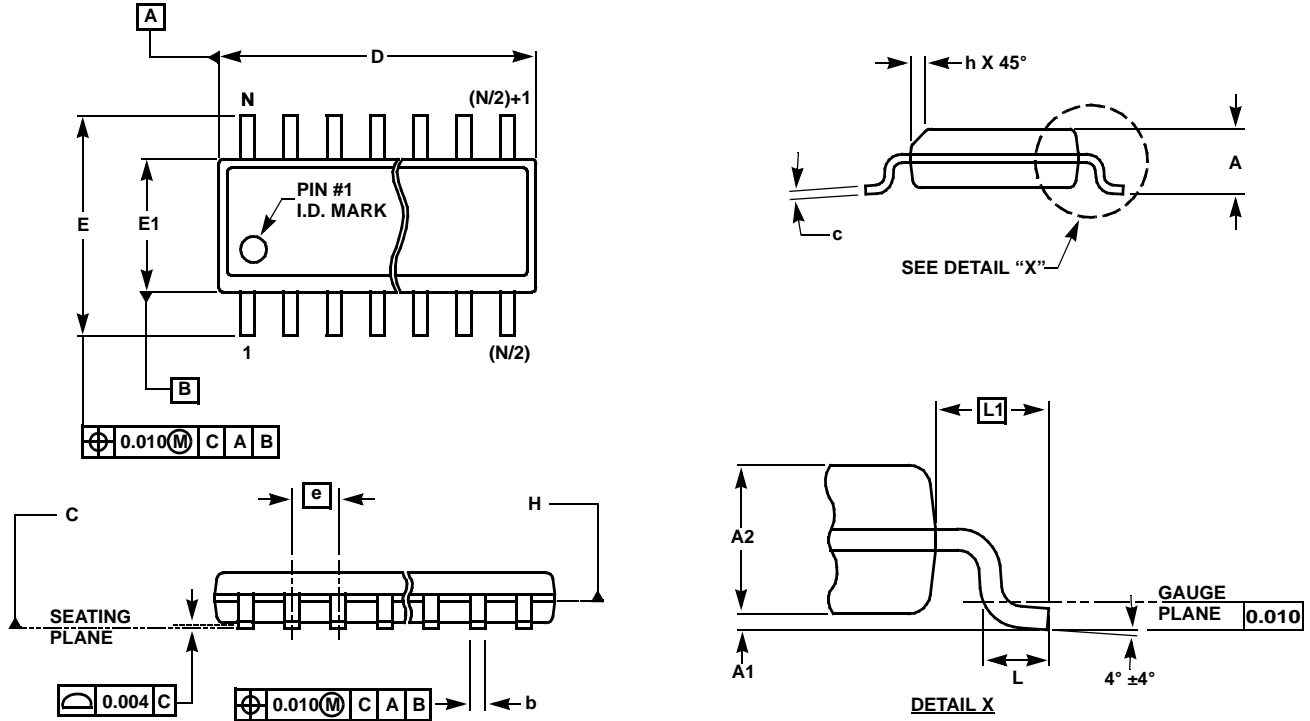

MDP0027

SMALL OUTLINE PACKAGE FAMILY (SO)

SYMBOL	INCHES							TOLERANCE	NOTES
	SO-8	SO-14	SO16 (0.150")	SO16 (0.300") (SOL-16)	SO20 (SOL-20)	SO24 (SOL-24)	SO28 (SOL-28)		
A	0.068	0.068	0.068	0.104	0.104	0.104	0.104	MAX	-
A1	0.006	0.006	0.006	0.007	0.007	0.007	0.007	±0.003	-
A2	0.057	0.057	0.057	0.092	0.092	0.092	0.092	±0.002	-
b	0.017	0.017	0.017	0.017	0.017	0.017	0.017	±0.003	-
c	0.009	0.009	0.009	0.011	0.011	0.011	0.011	±0.001	-
D	0.193	0.341	0.390	0.406	0.504	0.606	0.704	±0.004	1, 3
E	0.236	0.236	0.236	0.406	0.406	0.406	0.406	±0.008	-
E1	0.154	0.154	0.154	0.295	0.295	0.295	0.295	±0.004	2, 3
e	0.050	0.050	0.050	0.050	0.050	0.050	0.050	Basic	-
L	0.025	0.025	0.025	0.030	0.030	0.030	0.030	±0.009	-
L1	0.041	0.041	0.041	0.056	0.056	0.056	0.056	Basic	-
h	0.013	0.013	0.013	0.020	0.020	0.020	0.020	Reference	-
N	8	14	16	16	20	24	28	Reference	-

Rev. M 2/07

NOTES:

1. Plastic or metal protrusions of 0.006" maximum per side are not included.
2. Plastic interlead protrusions of 0.010" maximum per side are not included.
3. Dimensions "D" and "E1" are measured at Datum Plane "H".
4. Dimensioning and tolerancing per ASME Y14.5M-1994

SOT-23 Package Family

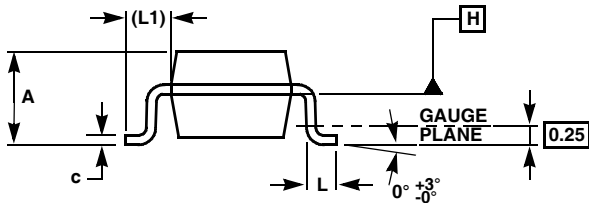
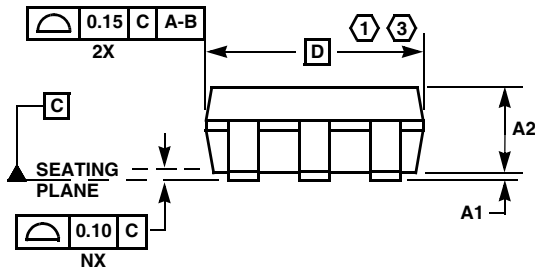
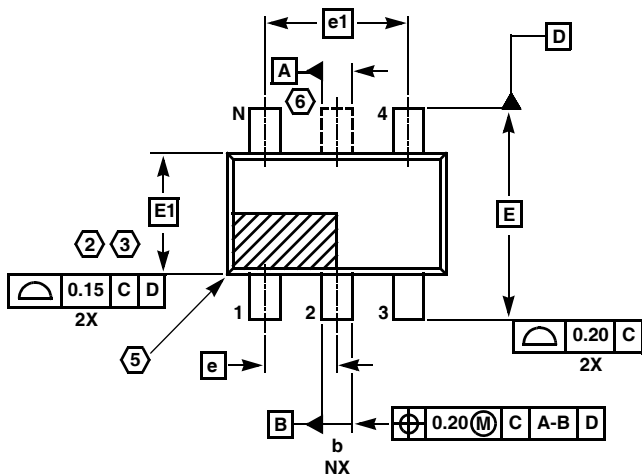

MDP0038

SOT-23 PACKAGE FAMILY

SYMBOL	MILLIMETERS		TOLERANCE
	SOT23-5	SOT23-6	
A	1.45	1.45	MAX
A1	0.10	0.10	±0.05
A2	1.14	1.14	±0.15
b	0.40	0.40	±0.05
c	0.14	0.14	±0.06
D	2.90	2.90	Basic
E	2.80	2.80	Basic
E1	1.60	1.60	Basic
e	0.95	0.95	Basic
e1	1.90	1.90	Basic
L	0.45	0.45	±0.10
L1	0.60	0.60	Reference
N	5	6	Reference

Rev. F 2/07

NOTES:

1. Plastic or metal protrusions of 0.25mm maximum per side are not included.
2. Plastic interlead protrusions of 0.25mm maximum per side are not included.
3. This dimension is measured at Datum Plane "H".
4. Dimensioning and tolerancing per ASME Y14.5M-1994.
5. Index area - Pin #1 I.D. will be located within the indicated zone (SOT23-6 only).
6. SOT23-5 version has no center lead (shown as a dashed line).

All Intersil U.S. products are manufactured, assembled and tested utilizing ISO9000 quality systems. Intersil Corporation's quality certifications can be viewed at www.intersil.com/design/quality

Intersil products are sold by description only. Intersil Corporation reserves the right to make changes in circuit design, software and/or specifications at any time without notice. Accordingly, the reader is cautioned to verify that data sheets are current before placing orders. Information furnished by Intersil is believed to be accurate and reliable. However, no responsibility is assumed by Intersil or its subsidiaries for its use; nor for any infringements of patents or other rights of third parties which may result from its use. No license is granted by implication or otherwise under any patent or patent rights of Intersil or its subsidiaries.

For information regarding Intersil Corporation and its products, see www.intersil.com