

## GaAs MMIC

- Dual mode power amplifier for CDMA /TDMA portable cellular phones
- 29 dBm linear output power@ PAE=40% typ.
- Fully integrated 2 stage amplifier
- Power ramp control
- Input matched to 50 ohms, simple output match

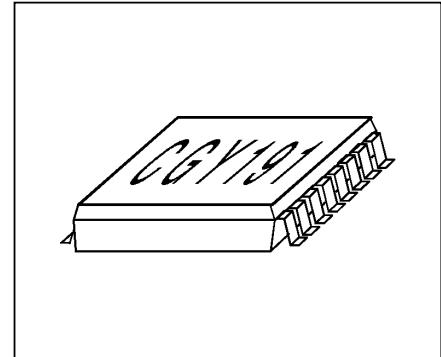

ESD: **E**lectrostatic **d**ischarge sensitive device, observe handling precautions!

Type	Marking	Ordering code (taped)	Package
CGY 191	CGY 191	Q62702G74	MW 16

## Maximum ratings

Characteristics	Symbol	max. Value	Unit
Positive supply voltage	$V_D$	9	V
Supply current	$I_D$	4	A
Channel temperature	$T_{Ch}$	150	°C
Storage temperature	$T_{stg}$	-55...+150	°C
Pulse peak power dissipation	$P_{Pulse}$	tbd	W
Total power dissipation ( $T_s \leq 80$ °C) <i>T<sub>s</sub>: Temperature at soldering point</i>	$P_{tot}$	tbd	W

## Thermal Resistance

Characteristics	Symbol	max. Value	Unit
Channel-soldering point	$R_{thChS}$	11	K/W

### Functional Block Diagram:

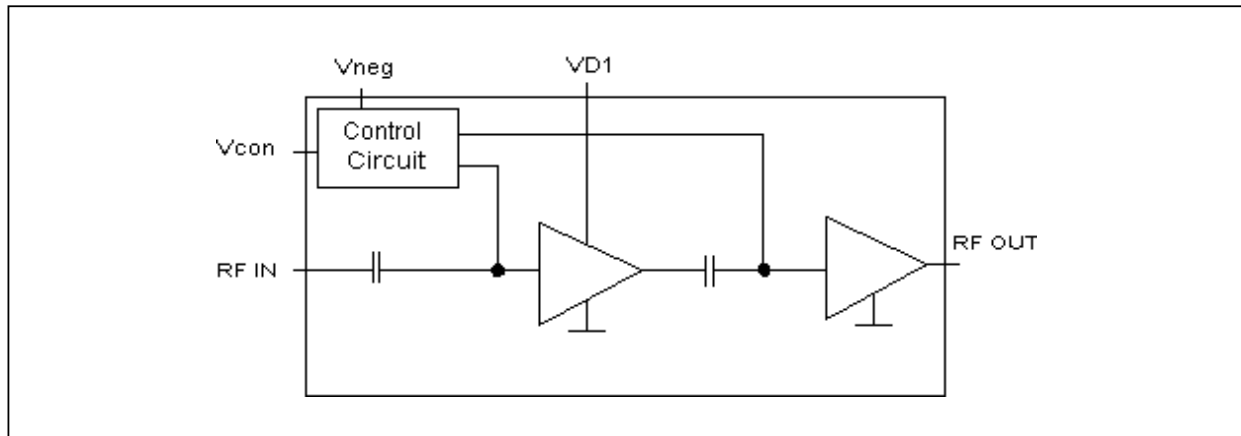

### Pin Configuration:

Pin #		Configuration
1	n. c.	
2	n. c.	
3	Vcon	Control voltage
4	Vneg	Negative voltage
5	n. c.	
6	RF IN	RF IN PCS Band
7	n. c.	
8	VD 1	Drain voltage preamplifier stage
9	n. c.	
10	n. c.	
11	RF out	RF out / drain voltage final stage
12	RF out	RF out / drain voltage final stage
13	RF out	RF out / drain voltage final stage
14	RF out	RF out / drain voltage final stage
15	n. c.	
16	n. c.	

## Electrical Characteristics

( $T_A = 25^\circ\text{C}$ ,  $Z_S = Z_L = 50 \text{ Ohm}$ ,  $V_D = 3.5\text{V}$ ,  $I_{DQ} = 300\text{mA}$ , unless otherwise specified)

Characteristics	Symbol	min	typ	max	Unit
Frequency range	$f$	1850		1910	MHz
Duty cycle	$t_{ON}/t_{OFF}$			100	%
TDMA output power	$P$		29		dBm
TDMA gain at max. output	$G$		24		dB
CDMA output power	$P$		29		dBm
CDMA gain at max. output	$G$		24		dB
Power ramping characteristic Full output power Pinch off	$V_{contr}$		2.5 0.5		V
Adjacent Channel Power CDMA 1.25 MHz offset (PCS band) 1.98 MHz offset	$P_{adj}/P_{main}$			-45 -54	dBc @ 30kHz
Adjacent channel power TDMA adjacent alternate 2nd alternate	$P_{adj}/P_{main}$			-28 -45 -45	dBc @ 30kHz
TDMA DC to RF efficiency @ $P_{adj} = -26\text{dBc}$ at max. output	PAE		40		%
CDMA DC to RF efficiency @ $P_{adj} = -42\text{dBc}$ at max. output  at 10 dBm output power	PAE		40 4		%
Receive band noise power density (1930 to 1990 MHz)	$P_{RX}$			-145	dBm/Hz
DC supply voltage range	$V_D$	2.9	3.5	4.0	V
Negative supply voltage range	$V_{neg}$	-5.0		-7.0	V
Standby current @ $V_{con} = 0\text{V}$	$I_{pwr\ dwn}$		500		$\mu\text{A}$

Characteristics	Symbol	min	typ	max	Unit
Quiescent current			300		mA
Current consumption at $V_{Contr}$	$I_{Control}$		2		mA
Current consumption at $V_{NEG}$	$I_{NEG}$		2		mA
Operating temperature range	$\nu$	-30		+85	°C

### Power on sequence:

1. connect negative voltage to PA
2. connect control voltage to PA
3. turn on  $V_d$
4. turn on  $P_{in}$

To switch off the device please use reverse sequence.

### Application Circuit:

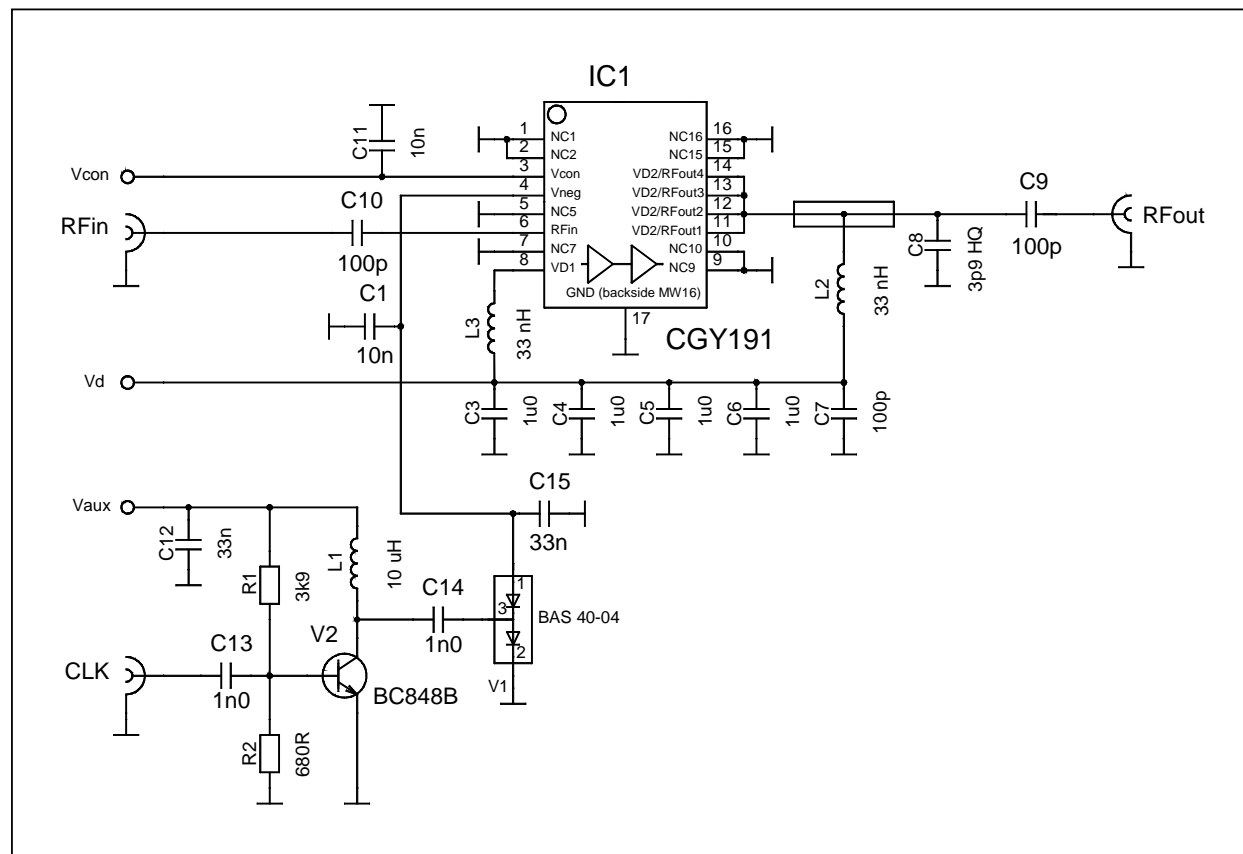

## Evaluation Board:

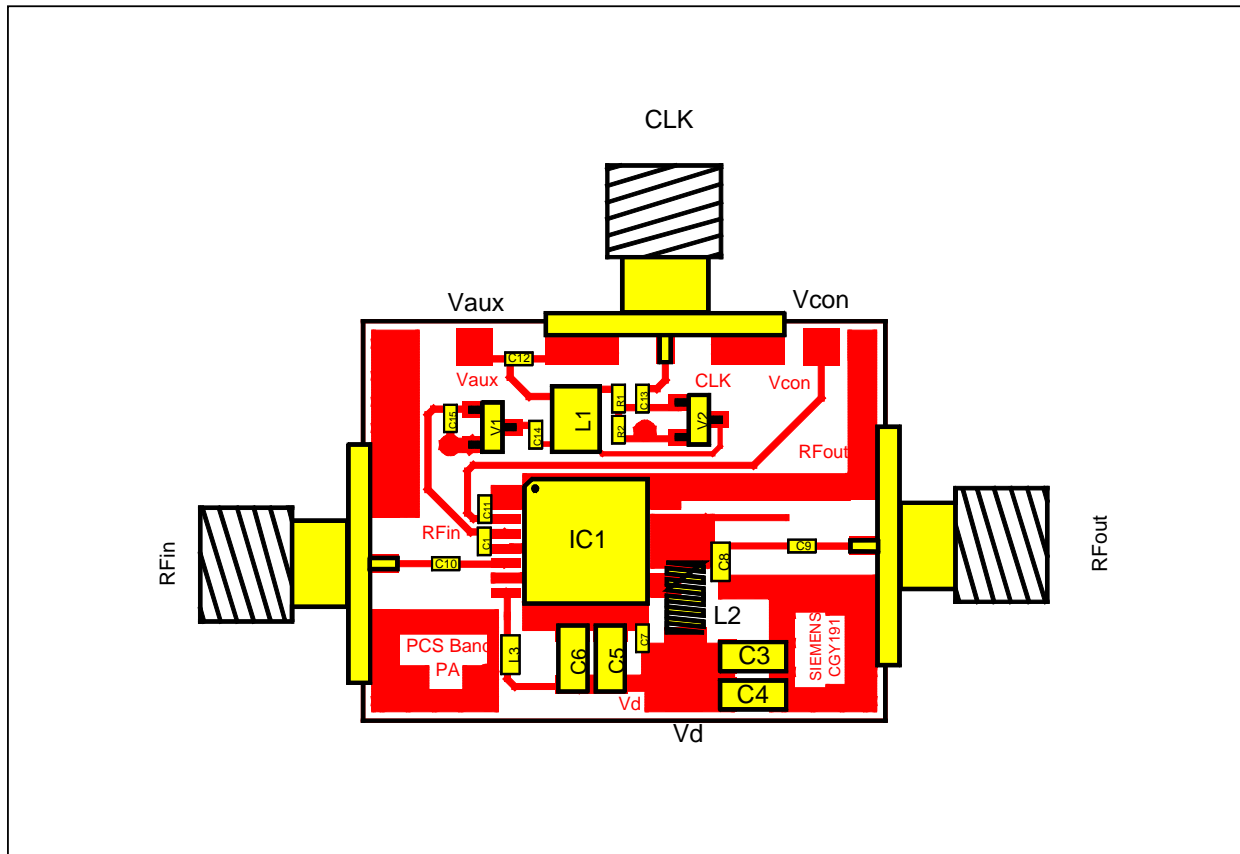

## Evaluation Board Parts List:

Part Type	Position	Description	Manufacturer	Part Number
Capacitor	C1, C11	10nF 0402	Siemens	
Capacitor	C7, C9, C10	100pF 0402	Siemens	
Capacitor	C8	3,9pF 0603 High Q	AVX	06035J3R9BBT
Capacitor	C3, C4, C5, C6	1uF 1206	Siemens	
Capacitor	C12, C15	33nF 0402	Siemens	
Capacitor	C13, C14	1nF 0402	Siemens	
Inductor	L1	10uH	Siemens	
Air Coil	L2	33nH	Horst David GmbH	PN/BV 1250
Inductor	L3	33nH 0603	Toko	
Resistor	R1	3,9k	Siemens	
Resistor	R2	680 Ohm	Siemens	
Diode	V1	BAS40-04W	Siemens	
Transistor	V2	BC848B	Siemens	
Substrate		FR4, h=0.2mm, $\epsilon_r=4.5$	Siemens	

## Typical Performance in CDMA Operation Mode:

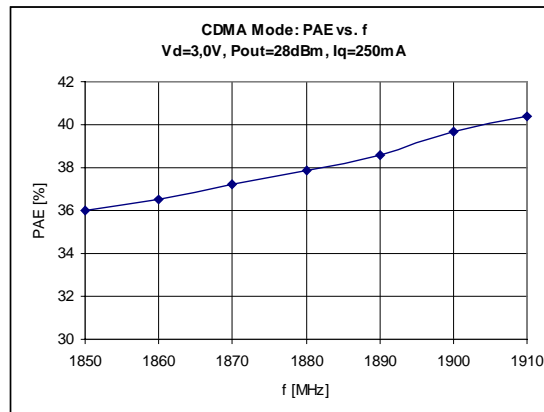
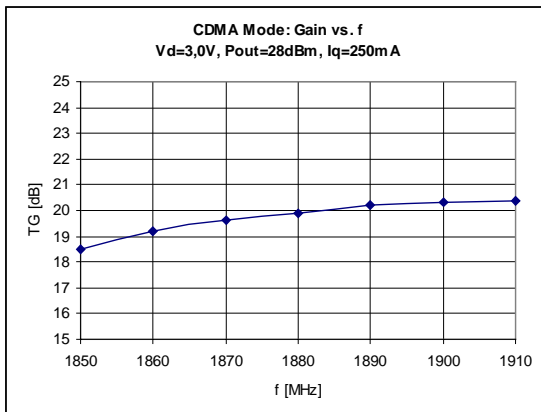
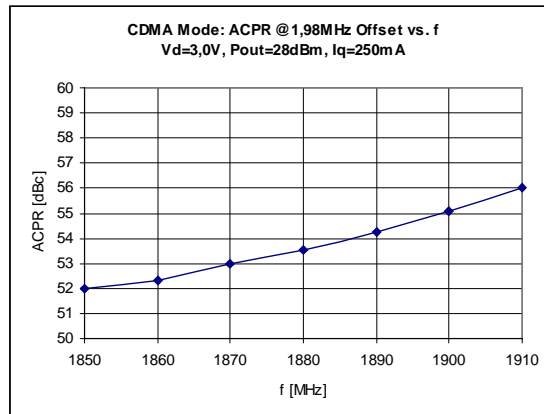
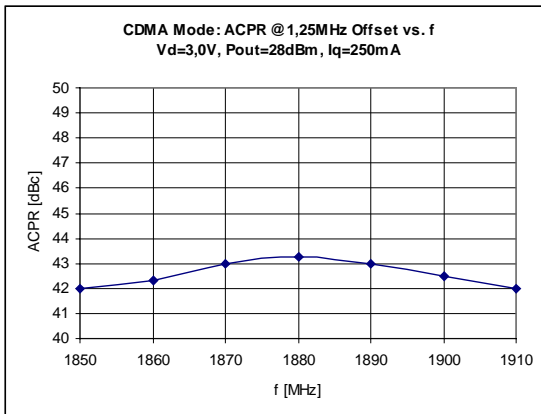
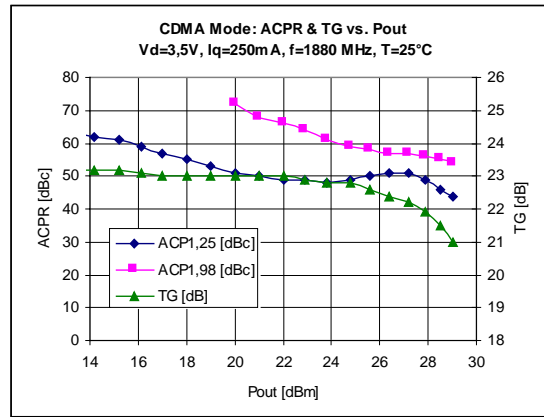
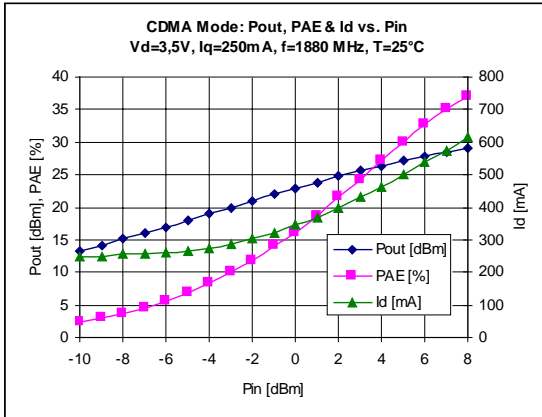

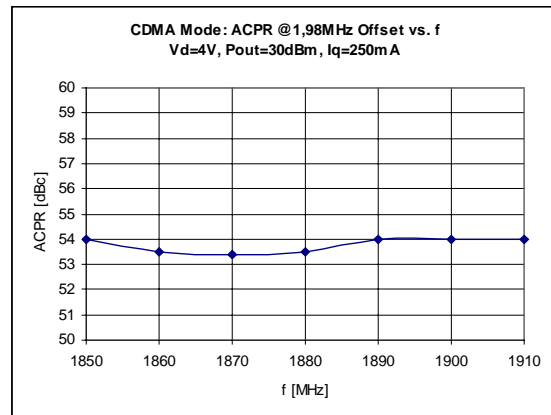
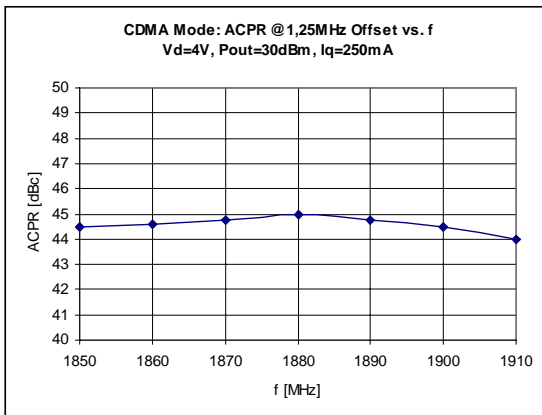
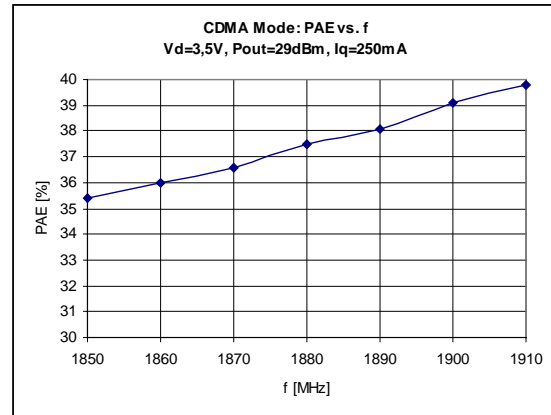
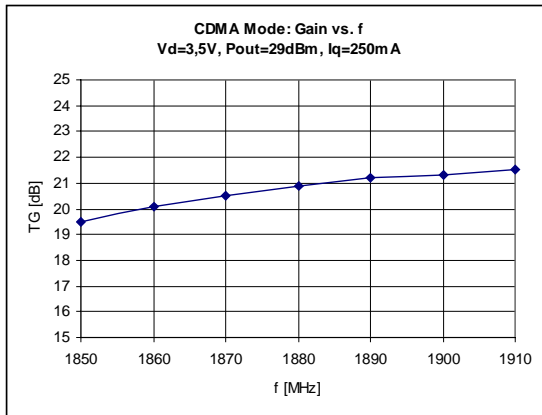
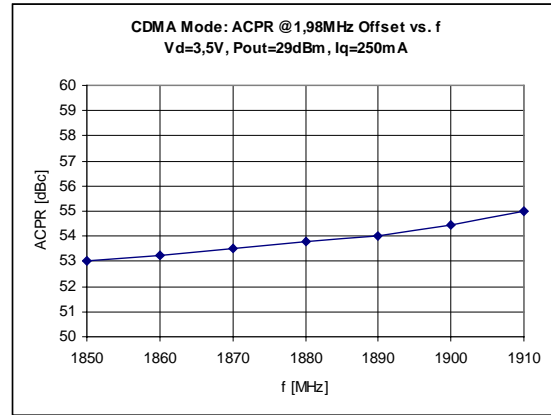
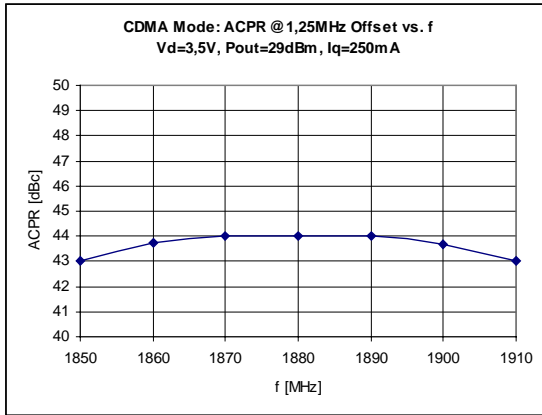

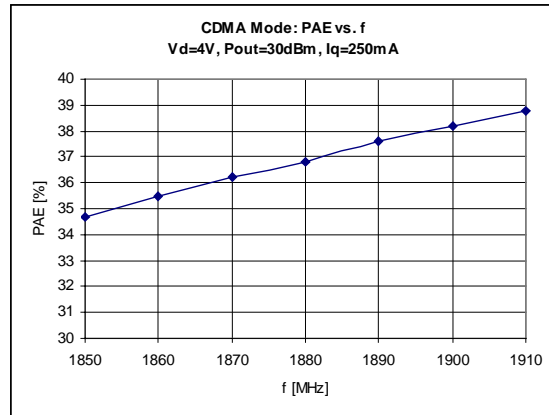
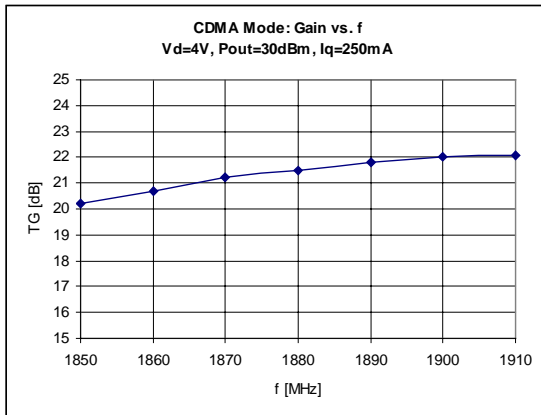

## Typical Performance in TDMA Operation Mode:

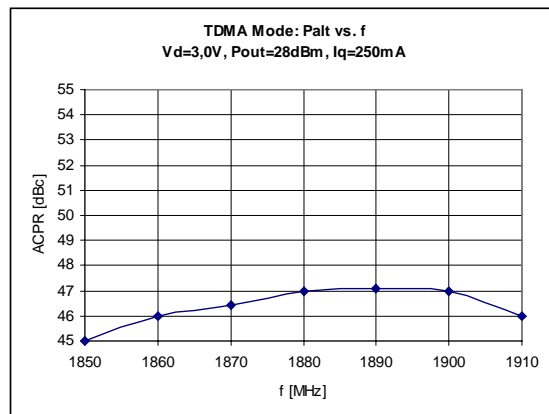
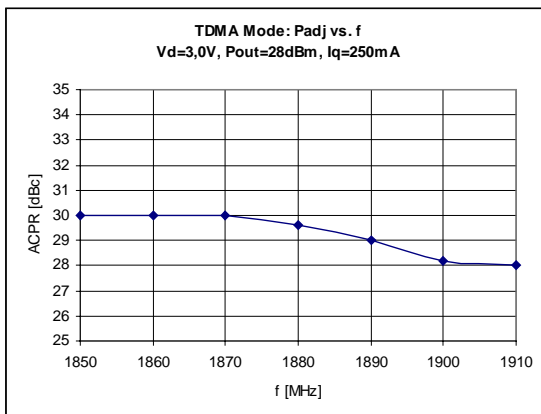
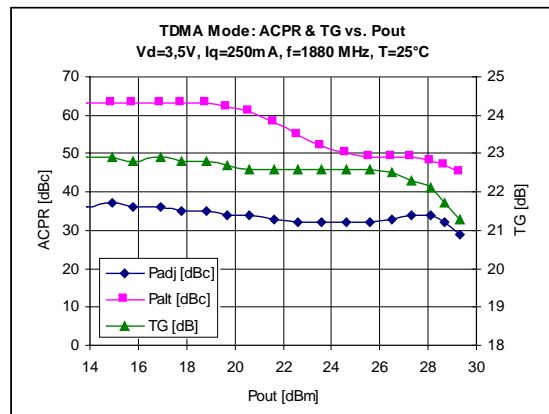
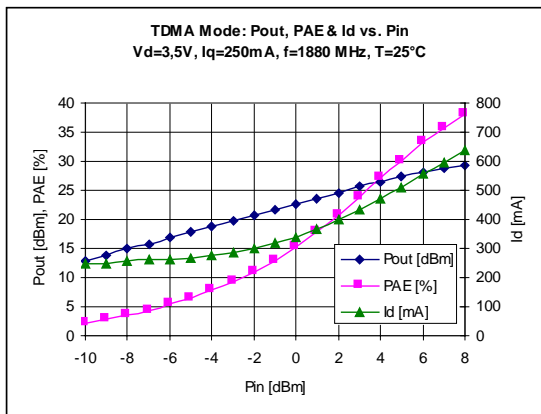



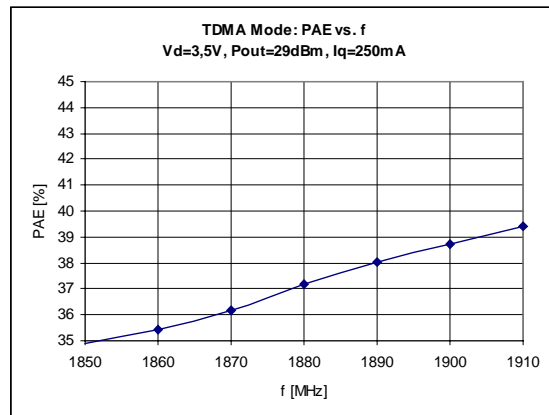
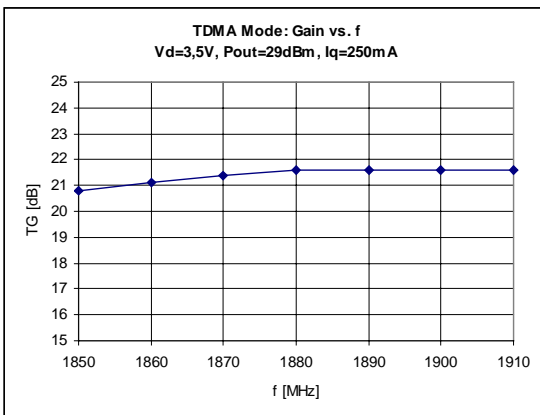
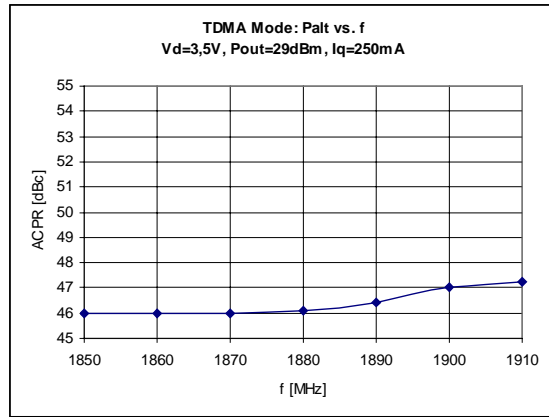
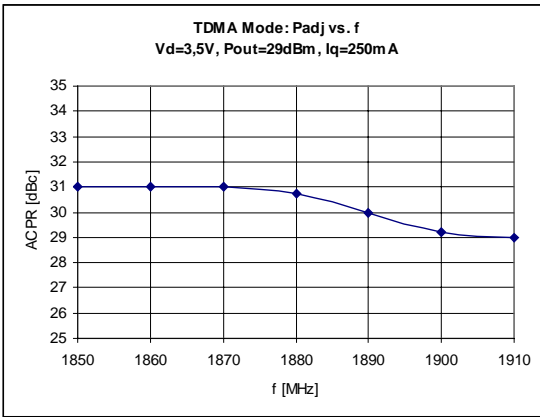
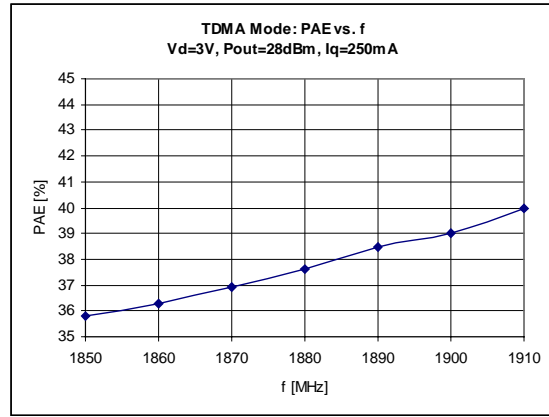
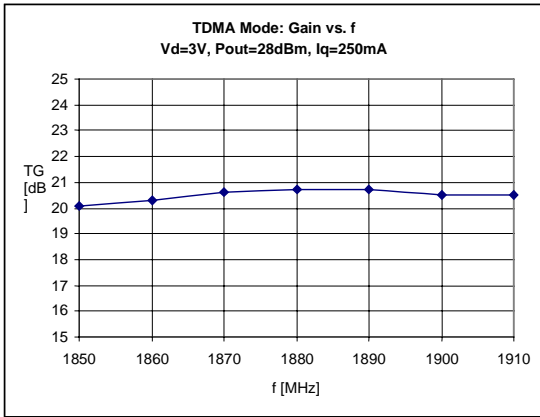

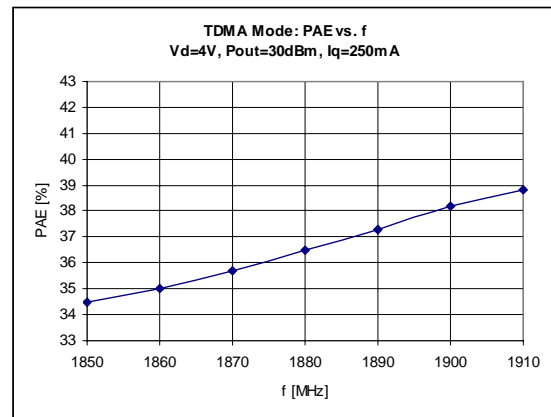
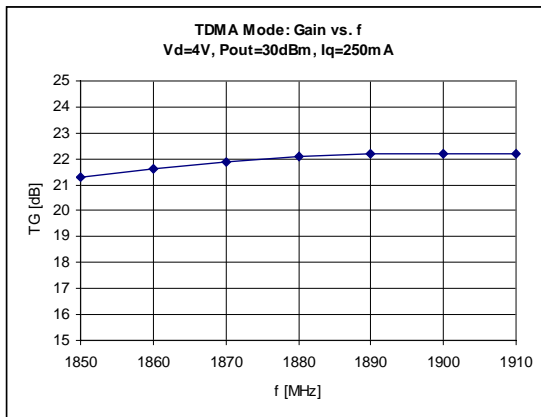
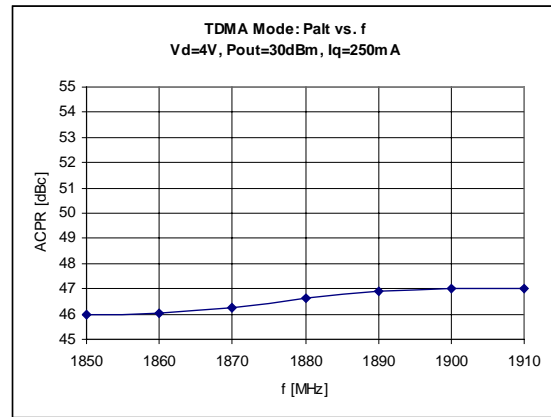
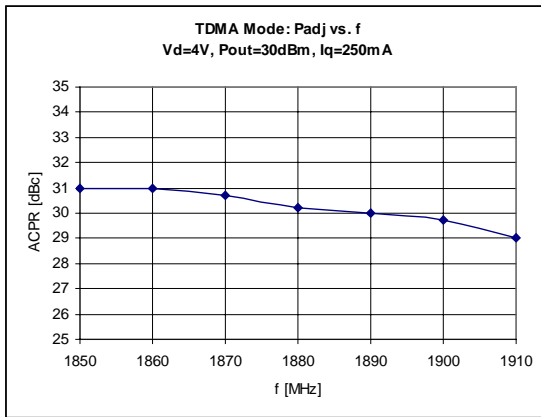

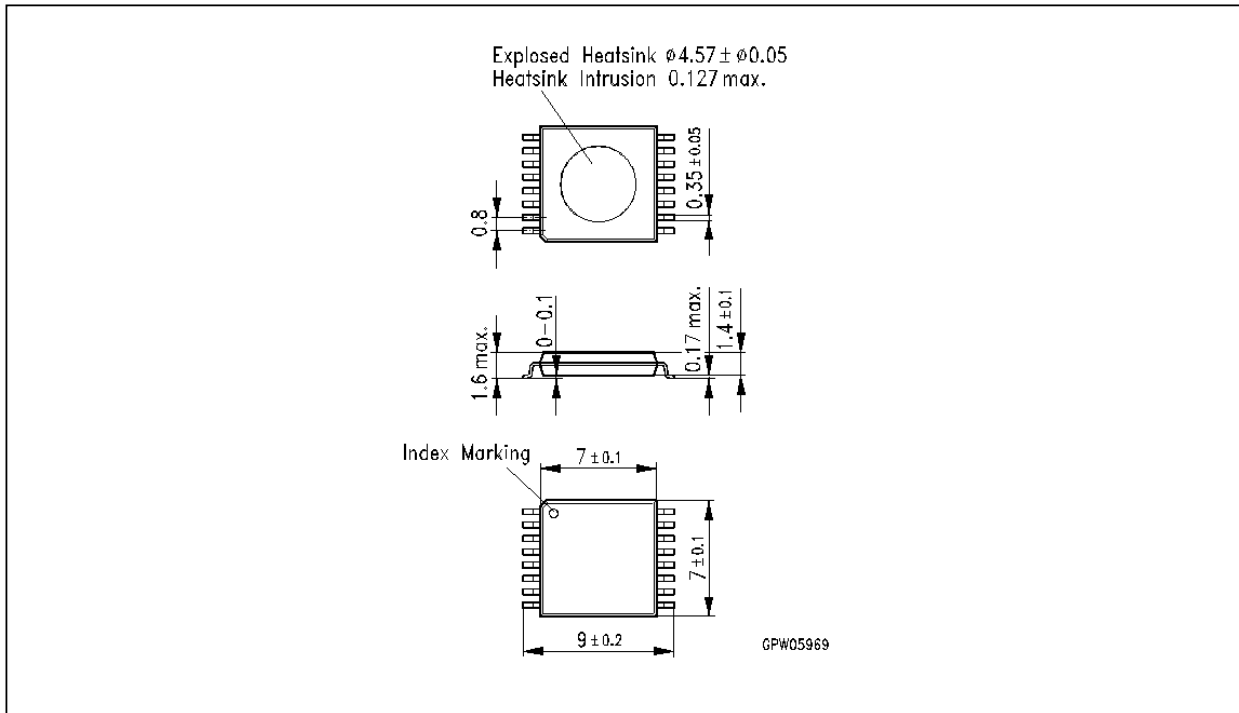

Published by Siemens AG, Bereich Bauelemente, Vertrieb,  
Produkt-Information, Balanstraße 73, D-81541 München

copyright Siemens AG 1996. All Rights Reserved

As far as patents or other rights of third parties are concerned, liability is only assumed for components per se, not for applications, processes and circuits implemented within components or assemblies.

The information describes the type of component and shall not be considered as assured characteristics.

Terms of delivery and rights to change design reserved.

For questions on technology, delivery and prices please contact the Offices of Semiconductor Group in Germany or the Siemens Companies and Representatives worldwide (see address list).

Due to technical requirements components may contain dangerous substances. For information on the type in question please contact your nearest Siemens Office, Semiconductor Group.

Siemens AG is an approved CECC manufacturer.