

LM48555 Boomer® Audio Power Amplifier Series

Ceramic Speaker Driver

General Description

The LM48555 is an audio power amplifier designed to drive ceramic speakers in applications such as cell phones, smart phones, PDAs and other portable devices. The LM48555 produces 15.7V_{P-P} with less than 1% THD+N while operating from a 3.2V power supply. The LM48555 features a low power shutdown mode, and differential inputs for improved noise rejection.

The LM48555 includes advanced click and pop suppression that eliminates audible turn-on and turn-off transients. Additionally, the integrated boost regulator features a soft start function that minimizes transient current during power-up

Boomer audio power amplifiers were designed specifically to provide high quality output power with a minimal number of external components. The LM48555 does not require bootstrap capacitors, or snubber circuits.

The LM48555 is unity-gain stable and uses external gain-setting resistors.

Key Specifications

- I_{DDQ} (Boost Converter + Amplifier) at V_{DD} = 5V 7.5mA (typ)
- Output Voltage Swing
V_{DD} = 3.2V, THD ≤ 1% 15.7V_{P-P} (typ)
- Power Supply Rejection Ratio
f = 217Hz 80dB (typ)

Features

- Fully differential amplifier
- Externally configurable gain
- Soft start function
- Low power shutdown mode
- Under voltage lockout

Applications

- Mobile phones
- PDA's
- Digital cameras

Typical Application

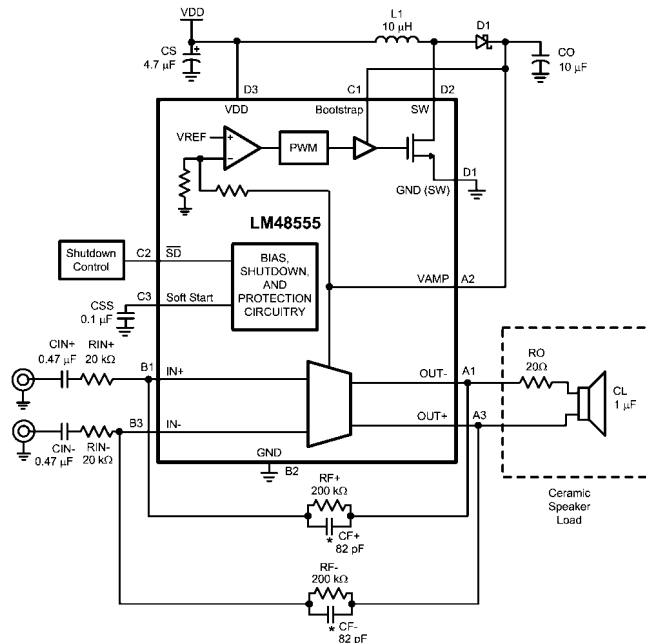

300099c9

* CF+ and CF- are optional. Refer to "Selecting Input and Feedback Capacitor and Resistor for Audio Amplifier" section.

FIGURE 1. Typical Audio Amplifier Application Circuit

Boomer® is a registered trademark of National Semiconductor Corporation.

Connection Diagrams

LM48555TL Bumps Down View

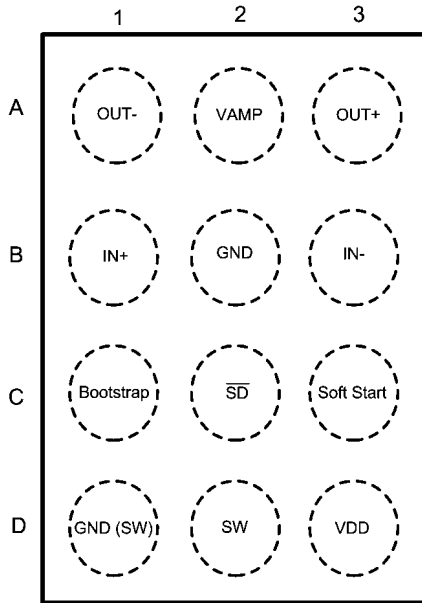

300099c8

Top View
Order Number LM48555TL
See NS Package Number TLA12Z1A

LM48555TL Marking Drawing

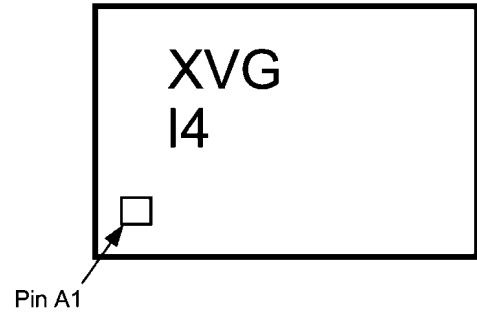

30009956

Top View
X = One digit date code
V = Die traceability
G = Boomer Family
I4 = LM48555TL

TLA12 Package View (Bumps Up)

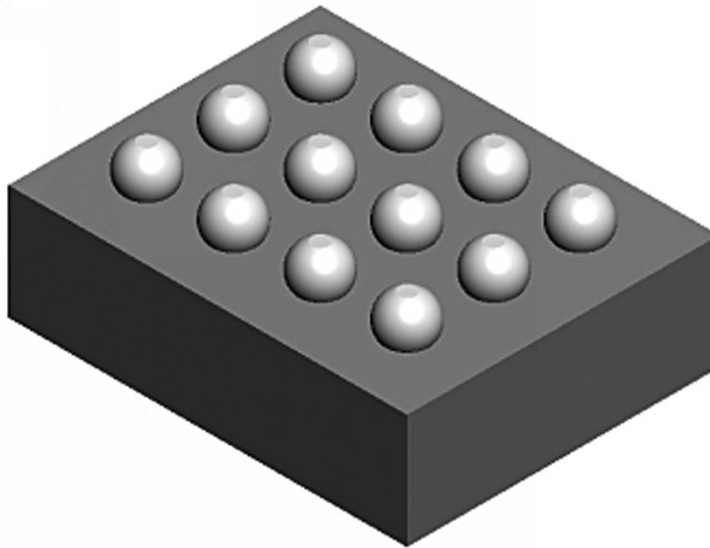

30009931

Absolute Maximum Ratings (Notes 1, 2)

If Military/Aerospace specified devices are required, please contact the National Semiconductor Sales Office/ Distributors for availability and specifications.

Supply Voltage (V_{DD})	9.5V
Storage Temperature	-65°C to +150°C
Input Voltage	-0.3V to $V_{DD} + 0.3V$
Power Dissipation (Note 3)	Internally limited
ESD Susceptibility (Note 4)	2000V
ESD Susceptibility (Note 5)	200V

Junction Temperature	150°C
Thermal Resistance	
θ_{JA} (Note 10)	114°C/W

Operating Ratings

Temperature Range	
$T_{MIN} \leq T_A \leq T_{MAX}$ (Note 10)	-40°C \leq T_A \leq +85°C
Supply Voltage (V_{DD})	2.7V \leq V_{DD} \leq 6.5V

Electrical Characteristics (Notes 1, 2)

The following specifications apply for $V_{DD} = 3.2V$ and the conditions shown in "Typical Audio Amplifier Application Circuit" (see Figure 1), unless otherwise specified. Limits apply for $T_A = 25^\circ C$.

Symbol	Parameter	Conditions	LM48555		Units (Limits)
			Typical (Note 6)	Limit (Notes 7, 8)	
I_{DD}	Quiescent Power Supply Current in Boosted Ringer Mode	$V_{IN} = 0V$, No Load			
		$V_{DD} = 5.0V$	7.5		mA
		$V_{DD} = 3.6V$	10		mA
		$V_{DD} = 3.2V$	12	15	mA (max)
I_{SD}	Shutdown Current	$\overline{SD} = GND$ (Note 9)	0.1	1	μA (max)
V_{LH}	Logic High Threshold Voltage			1.2	V (min)
V_{LL}	Logic Low Threshold Voltage			0.4	V (max)
$R_{PULLDOWN}$	Pulldown Resistor on \overline{SD} pin		80	53	k Ω (min)
T_{WU}	Wake-up Time	$CSS = 0.1\mu F$	100		ms
V_{AMP}	Boost Converter Output Voltage	Voltage on V_{AMP} Pin	8	8.5 7.5	V (max) V (min)
V_{OUT}	Output Voltage Swing	THD = 1% (max); $f = 1kHz$	15.7	15	V_{P-P} (min)
THD+N	Total Harmonic Distortion + Noise	$V_{OUT} = 14V_{P-P}$, $f = 1kHz$	0.05	0.5	% (max)
ϵ_{OS}	Output Noise	A-Weighted Filter, $V_{IN} = 0V$	70		μV
PSRR	Power Supply Rejection Ratio	$V_{RIPPLE} = 200mV_{P-P}$, $f = 217Hz$, $A_V = 20dB$	80	72	dB (min)
I_{SW}	Switch Current Limit		2		A
V_{OS}	Output Offset Voltage		0.5	4.5	mV (max)
CMRR	Common Mode Rejection Ratio	Input referred	70	65	dB (min)
UVLO	Under-Voltage Lock Out		2.5	2.6	V (max)
$R_{DS(ON)}$	Switch ON resistance		0.3		Ω

Note 1: All voltages are measured with respect to the GND pin, unless otherwise specified.

Note 2: *Absolute Maximum Ratings* indicate limits beyond which damage to the device may occur. *Operating Ratings* indicate conditions for which the device is functional, but do not guarantee specific performance limits. *Electrical Characteristics* state DC and AC electrical specifications under particular test conditions which guarantee specific performance limits. This assumes that the device is within the Operating Ratings. Specifications are not guaranteed for parameters where no limit is given, however, the typical value is a good indication of device performance.

Note 3: The maximum power dissipation must be derated at elevated temperatures and is dictated by T_{JMAX} , θ_{JA} , and the ambient temperature, T_A . The maximum allowable power dissipation is $P_{DMAX} = (T_{JMAX} - T_A) / \theta_{JA}$ or the given in Absolute Maximum Ratings, whichever is lower.

Note 4: Human body model, 100pF discharged through a 1.5k Ω resistor.

Note 5: Machine Model, 220pF–240pF discharged through all pins.

Note 6: Typicals are measured at 25°C and represent the parametric norm.

Note 7: Limits are guaranteed to National's AOQL (Average Outgoing Quality Level).

Note 8: Datasheet min/max specification limits are guaranteed by design, test, or statistical analysis.

Note 9: Shutdown current is measured in a normal room environment. The SD pin should be driven as close as possible to GND for minimum shutdown current.

Note 10: The value for θ_{JA} is measured with the LM48555 mounted on a 3" x 1.5" (76.2mm x 3.81mm) four layer board. The copper thickness for all four layers is 0.5oz (roughly 0.18mm).

Typical Performance Characteristics

THD+N vs Frequency
 $V_O = 4.95V_{RMS}$, $V_{DD} = 3.2V$,
 $Z_L = 1\mu F + 20\Omega$

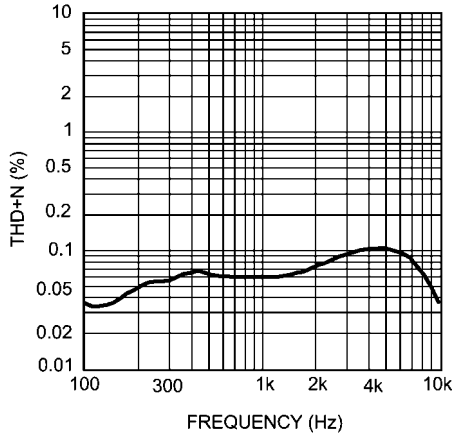

30009950

THD+N vs Frequency
 $V_O = 4.95V_{RMS}$, $V_{DD} = 4.2V$,
 $Z_L = 1\mu F + 20\Omega$

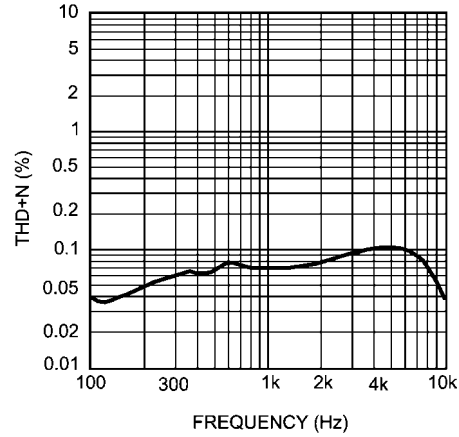

30009951

THD+N vs Frequency
 $V_O = 4.95V_{RMS}$, $V_{DD} = 5V$,
 $Z_L = 1\mu F + 20\Omega$

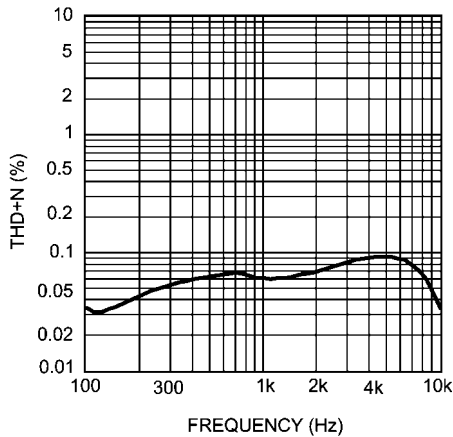

30009952

THD+N vs Output Voltage Swing
 $V_{DD} = 3.2V$, $Z_L = 1\mu F + 20\Omega$

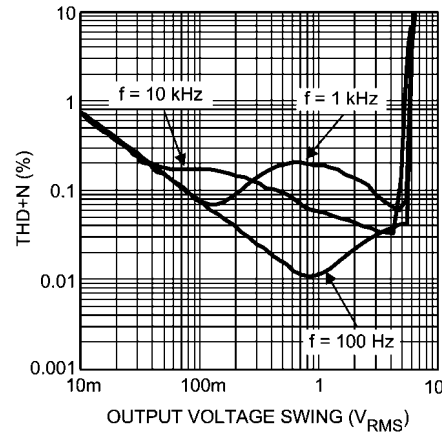

30009964

THD+N vs Output Voltage Swing
 $V_{DD} = 4.2V$, $Z_L = 1\mu F + 20\Omega$

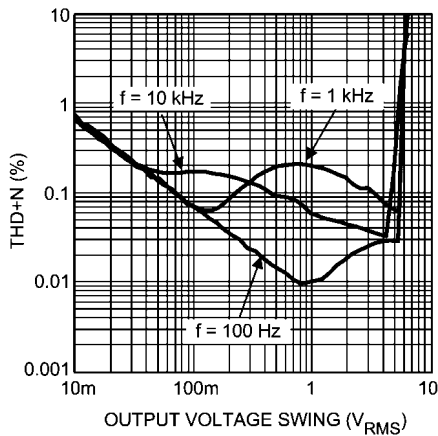

30009965

THD+N vs Output Voltage Swing
 $V_{DD} = 5V$, $Z_L = 1\mu F + 20\Omega$

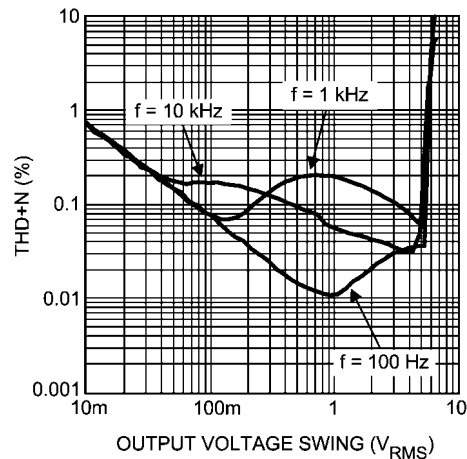

30009969

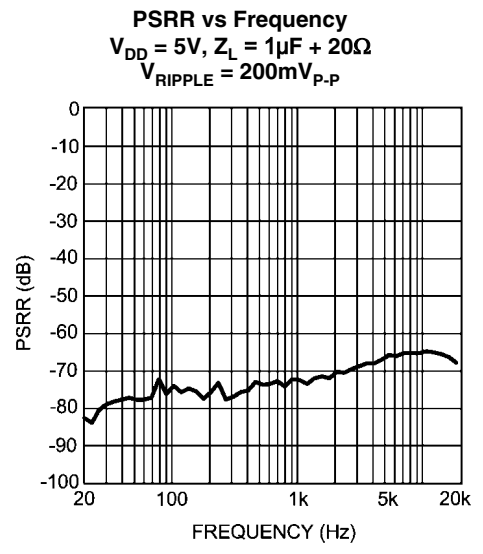
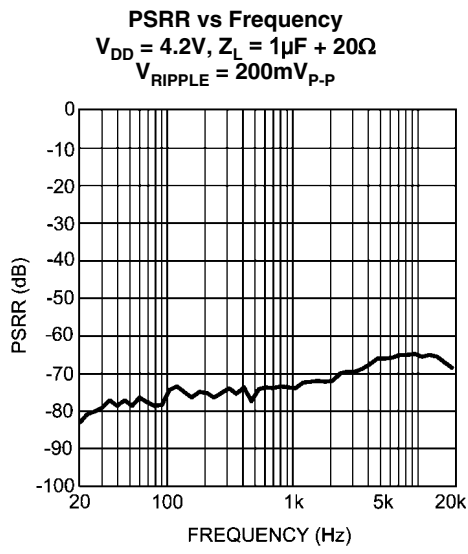
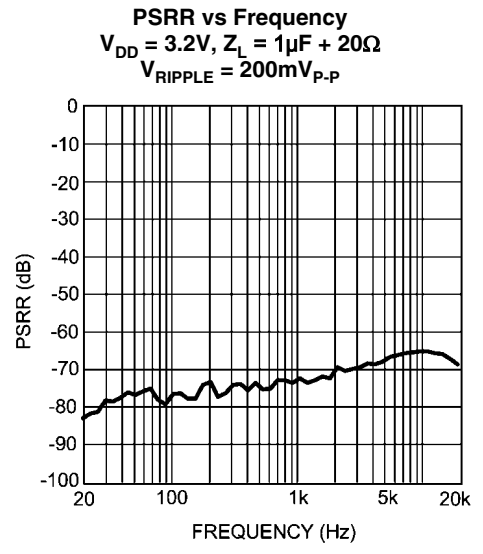
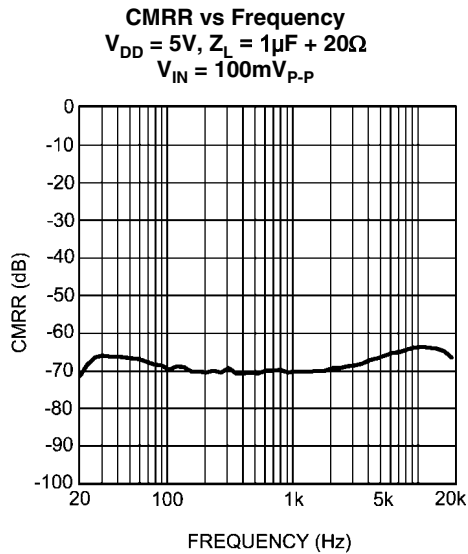
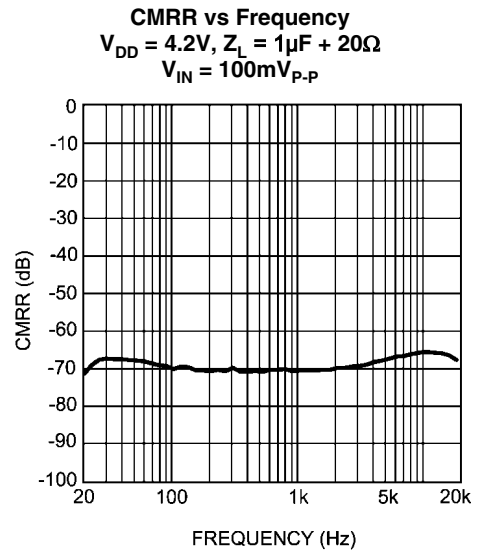
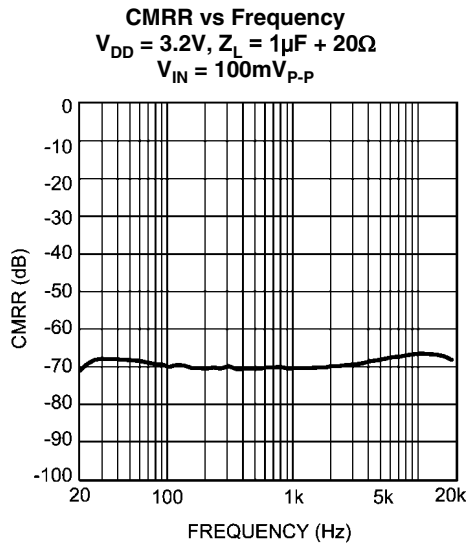

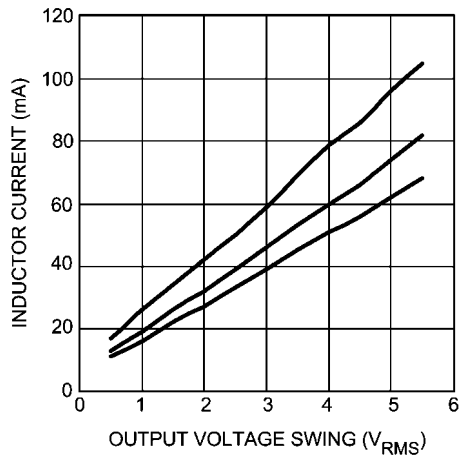
Inductor Current vs Output Voltage Swing $Z_L = 1\mu\text{F} + 20\Omega$, $f = 1\text{kHz}$,
 $V_{DD} = 3\text{V}, 4.2\text{V}, 5\text{V}$ 

30009960

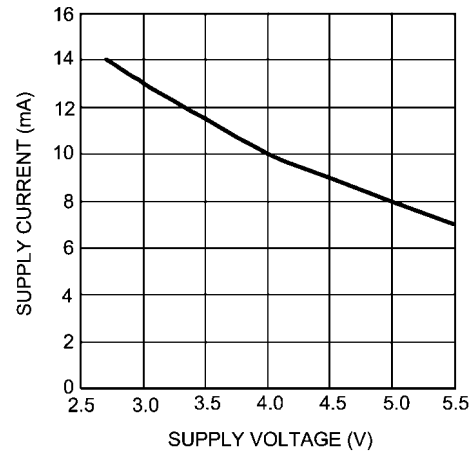
Supply Current vs Supply Voltage

30009967

Application Information

CHARACTERISTICS OF CERAMIC SPEAKERS

Because of their ultra-thin profile piezoelectric ceramic speakers are ideal for portable applications. Piezoelectric materials have high dielectric constants and their component electrical property is like a capacitor. Therefore, piezoelectric ceramic speakers essentially represent capacitive loads over frequency. Because these speakers are capacitive rather than resistive, they require less current than traditional moving coil speakers. However, ceramic speakers require high driving voltages (approximately $15V_{P-P}$). To achieve these high output voltages in battery operated applications, the LM48555 integrates a boost converter with an audio amplifier. High quality piezoelectric ceramic speakers are manufactured by TayioYuden (www.t-yuden.com) and muRata (www.murata.com). Tayio Yuden's MLS-A Series Ceramic Speaker and Murata's piezoelectric speaker VSL series are recommended.

DIFFERENTIAL AMPLIFIER EXPLANATION

The LM48555 includes a fully differential audio amplifier that features differential input and output stages. Internally this is accomplished by two circuits: a differential amplifier and a common mode feedback amplifier that adjusts the output voltages so that the average value remains $V_{DD}/2$. When setting the differential gain, the amplifier can be considered to have "halves". Each half uses an input and feedback resistor (R_{IN-} and R_{F-}) to set its respective closed-loop gain (see Figure 1). With $R_{IN+} = R_{IN-}$ and $R_{F+} = R_{F-}$, the gain is set at $-R_{F-}/R_{IN-}$ for each half. This results in a differential gain of

$$A_{VD} = -R_{F-}/R_{IN-} \quad (1)$$

It is extremely important to match the input resistors, as well as the feedback resistors to each other for best amplifier performance. A differential amplifier works in a manner where the difference between the two input signals is amplified. In most applications, this would require input signals that are 180° out of phase with each other. The LM48555 can be used, however, as a single-ended input amplifier while still retaining its fully differential benefits. In fact, completely unrelated signals may be placed at the input pins. The LM48555 simply amplifies the difference between them.

The LM48555 provides what is known as a "bridged mode" output (bridge-tied-load, BTL). This results in output signals at $OUT+$ and $OUT-$ that are 180° out of phase with respect to each other. Bridged mode operation is different from the traditional single-ended amplifier configuration that connects the load between the amplifier output and ground. A bridged amplifier design has advantages over the single-ended configuration: it provides differential drive to the load, thus doubling maximum possible output swing for a specific supply voltage. Up to four times the output power is possible compared with a single-ended amplifier under the same conditions.

A bridged configuration, such as the one used in the LM48555, also creates a second advantage over single-ended amplifiers. Since the differential outputs, $OUT+$ and $OUT-$, are biased at half-supply, no net DC voltage exists across the load. This assumes that the input resistor pair and the feedback resistor pair are properly matched. BTL configuration eliminates the output coupling capacitor required in single supply, single-ended amplifier configurations. If an output coupling capacitor is not used in a single-ended output configuration, the half-supply bias across the load would result in

both increased internal IC power dissipation as well as permanent loudspeaker damage.

BOOST CONVERTER POWER DISSIPATION

At higher duty cycles, the increased ON-time of the switch FET means the maximum output current will be determined by power dissipation within the LM48555 FET switch. The switch power dissipation from ON-time conduction is calculated by Equation 2.

$$P_{D(SWITCH)} = DC \times (I_{INDUCTOR(AVE)})^2 \times R_{DS(ON)} \quad (W) \quad (2)$$

where DC is the duty cycle.

There will be some switching losses in addition to the power loss calculated in Equation 3, so some derating needs to be applied when calculating IC power dissipation. See "Maximum Power Dissipation" section.

MAXIMUM AMPLIFIER POWER DISSIPATION

Power dissipation is a major concern when designing a successful amplifier, whether the amplifier is bridged or single-ended. A direct consequence of the increased power delivered to the load by a bridge amplifier is an increase in internal power dissipation. Since the amplifier portion of the LM48555 has two operational amplifiers, the maximum internal power dissipation is 4 times that of a single-ended amplifier. The maximum power dissipation for a given BTL application can be derived from Equation 3.

$$P_{D(MAX(AMP))} = (2V_{DD}^2) / (\pi^2 RO) \quad (W) \quad (3)$$

MAXIMUM TOTAL POWER DISSIPATION

The total power dissipation for the LM48555 can be calculated by adding Equation 2 and Equation 3 together to establish Equation 4:

$$P_{D(MAX(TOTAL))} = (2V_{DD}^2) / (\pi^2 EFF^2 RO) \quad (W) \quad (4)$$

where

EFF = Efficiency of boost converter

The result from Equation 4 must not be greater than the power dissipation that results from Equation 5:

$$P_{D(MAX)} = (T_{JMAX} - T_A) / \theta_{JA} \quad (W) \quad (5)$$

For the TLA12Z1A, $\theta_{JA} = 114^\circ C/W$. $T_{JMAX} = 150^\circ C$ for the LM48555. Depending on the ambient temperature, T_A , of the system surroundings, Equation 5 can be used to find the maximum internal power dissipation supported by the IC packaging. If the result of Equation 4 is greater than that of Equation 5, then either the supply voltage must be decreased, the load impedance increased or T_A reduced. For typical applications, power dissipation is not an issue. Power dissipation is a function of output power and thus, if typical operation is not around the maximum power dissipation point, the ambient temperature may be increased accordingly.

STARTUP SEQUENCE

Correct startup sequencing is important for optimal device performance. Using the correct startup sequence will improve click and pop performance as well as avoid transients that could reduce battery life. The device should be in Shutdown mode when the supply voltage is applied. Once the supply voltage has been supplied the device can be released from Shutdown mode.

SHUTDOWN FUNCTION

In many applications, a microcontroller or microprocessor output is used to control the shutdown circuitry to provide a

quick, smooth transition into shutdown. Another solution is to use a single-pole, single-throw switch connected between V_{DD} and Shutdown pins.

BOOTSTRAP PIN

The bootstrap pin provides a voltage supply for the internal switch driver. Connecting the bootstrap pin to VAMP (See Figure 1) allows for a higher voltage to drive the gate of the switch thereby reducing the $R_{DS(ON)}$. This configuration is necessary in applications with heavier loads. The bootstrap pin can be connected to V_{DD} when driving lighter loads to improve device performance (I_{DD} , THD+N, Noise, etc.).

PROPER SELECTION OF EXTERNAL COMPONENTS

Proper selection of external components in applications using integrated power amplifiers, and switching DC-DC converters, is critical for optimizing device and system performance. Consideration to component values must be used to maximize overall system quality. The best capacitors for use with the switching converter portion of the LM48555 are multi-layer ceramic capacitors. They have the lowest ESR (equivalent series resistance) and highest resonance frequency, which makes them optimum for high frequency switching converters. When selecting a ceramic capacitor, only X5R and X7R dielectric types should be used. Other types such as Z5U and Y5F have such severe loss of capacitance due to effects of temperature variation and applied voltage, they may provide as little as 20% of rated capacitance in many typical applications. Always consult capacitor manufacturer's data curves before selecting a capacitor. High-quality ceramic capacitors can be obtained from Taiyo-Yuden and Murata.

POWER SUPPLY BYPASSING

As with any amplifier, proper supply bypassing is critical for low noise performance and high power supply rejection. The capacitor location on both V1 and V_{DD} pins should be as close to the device as possible.

SELECTING INPUT AND FEEDBACK CAPACITORS AND RESISTOR FOR AUDIO AMPLIFIER

Special care must be taken to match the values of the feedback resistors (RF+ and RF-) to each other as well as matching the input resistors (RIN+ and RIN-) to each other (see Figure 1). Because of the balanced nature of differential amplifiers, resistor matching differences can result in net DC currents across the load. This DC current can increase power consumption, internal IC power dissipation, reduce PSRR, and possibly damage the loudspeaker. To achieve best performance with minimum component count, it is highly recommended that both the feedback and input resistors match to 1% tolerance or better.

The input coupling capacitors, CIN, forms a first order high pass filter which limits low frequency response. This value should be chosen based on needed frequency response. High value input capacitors are both expensive and space hungry in portable designs. A certain value capacitor is needed to couple in low frequencies without severe attenuation. Ceramic speakers used in portable systems, whether internal or external, have little ability to reproduce signals below 100Hz to 150Hz. Thus, using a high value input capacitor may not increase actual system performance. In addition to system cost and size, click and pop performance is affected by the value of the input coupling capacitor, CIN. A high value input coupling capacitor requires more charge to reach its quiescent DC voltage (nominally $1/2 V_{DD}$). This charge comes from the output via the feedback and is apt to create pops upon device enable. Thus, by minimizing the capacitor value

based on desired low frequency response, turn-on pops can be minimized.

The LM48555 is unity-gain stable which gives the designer maximum system flexibility. However, to drive ceramic speakers, a typical application requires a closed-loop differential gain of 10V/V. In this case, feedback capacitors (CF+, CF-) may be needed as shown in Figure 1 to bandwidth limit the amplifier. If the available input signal is bandwidth limited, then capacitors CF+ and CF- can be eliminated. These feedback capacitors create a low pass filter that eliminates possible high frequency noise. Care should be taken when calculating the -3dB frequency (from equation 6) because an incorrect combination of RF and CF will cause rolloff before the desired frequency.

$$f_{-3dB} = 1 / 2\pi RF * CF \quad (6)$$

SELECTING OUTPUT CAPACITOR (CO) FOR BOOST CONVERTER

A single 4.7 μ F to 10 μ F ceramic capacitor will provide sufficient output capacitance for most applications. If larger amounts of capacitance are desired for improved line support and transient response, tantalum capacitors can be used. Aluminum electrolytics with ultra low ESR such as Sanyo Oscon can be used. Typical electrolytic capacitors are not suitable for switching frequencies above 500 kHz because of significant ringing and temperature rise due to self-heating from ripple current. An output capacitor with excessive ESR can also reduce phase margin and cause instability. In general, if electrolytics are used, it is recommended that they be paralleled with ceramic capacitors to reduce ringing, switching losses, and output voltage ripple.

SELECTING A POWER SUPPLY BYPASS CAPACITOR

A supply bypass capacitor is required to serve as an energy reservoir for the current which must flow into the coil each time the switch turns on. This capacitor must have extremely low ESR, so ceramic capacitors are the best choice. A nominal value of 4.7 μ F is recommended, but larger values can be used. Since this capacitor reduces the amount of voltage ripple seen at the input pin, it also reduces the amount of EMI passed back along that line to other circuitry.

SELECTING A SOFT-START CAPACITOR (CSS)

The soft-start function charges the boost converter reference voltage slowly. This allows the output of the boost converter to ramp up slowly thus limiting the transient current at startup. Selecting a soft-start capacitor (CSS) value presents a trade off between the wake-up time and the startup transient current. Using a larger capacitor value will increase wake-up time and decrease startup transient current while the opposite effect happens with a smaller capacitor value. A general guideline is to use a capacitor value 1000 times smaller than the output capacitance of the boost converter (CO). A 0.1 μ F soft-start capacitor is recommended for a typical application.

SELECTING DIODES

The external diode used in Figure 1 should be a Schottky diode. A 20V diode such as the MBR0520 from Fairchild Semiconductor or ON Semiconductor is recommended. The MBR05XX series of diodes are designed to handle a maximum average current of 0.5A. For applications exceeding 0.5A average but less than 1A, a Microsemi UPS5817 can be used.

OUTPUT VOLTAGE OF BOOST CONVERTER

The output voltage is set using two internal resistors. The output voltage of the boost converter is set to 8V (typ).

DUTY CYCLE

The maximum duty cycle of the boost converter determines the maximum boost ratio of output-to-input voltage that the converter can attain in continuous mode of operation. The duty cycle for a given boost application is defined by equation 7:

$$\text{Duty Cycle} = (V_{\text{AMP}} + V_{\text{DIODE}} - V_{\text{DD}}) / (V_{\text{AMP}} + V_{\text{DIODE}} - V_{\text{SW}}) \quad (7)$$

This applies for continuous mode operation.

INDUCTANCE VALUE

Inductor value involves trade-offs in performance. Larger inductors reduce inductor ripple current, which typically means less output voltage ripple (for a given size of output capacitor). Larger inductors also mean more load power can be delivered because the energy stored during each switching cycle is:

$$E = L/2 \times I_p^2 \quad (8)$$

Where "I_p" is the peak inductor current. The LM48555 will limit its switch current based on peak current. With I_p fixed, increasing L will increase the maximum amount of power available to the load. Conversely, using too little inductance may limit the amount of load current which can be drawn from the output. Best performance is usually obtained when the converter is operated in "continuous" mode at the load current range of interest, typically giving better load regulation and less output ripple. Continuous operation is defined as not allowing the inductor current to drop to zero during the cycle. Boost converters shift over to discontinuous operation if the load is reduced far enough, but a larger inductor stays continuous over a wider load current range.

INDUCTOR SUPPLIERS

The recommended inductors for the LM48555 are the Taiyo-Yuden NR4012, NR3010, and CBC3225 series and Murata's LQH3NPN series. When selecting an inductor, the continuous current rating must be high enough to avoid saturation at peak currents. A suitable core type must be used to minimize

core (switching) losses, and wire power losses must be considered when selecting the current rating.

CALCULATING OUTPUT CURRENT OF BOOST CONVERTER (I_{AMP})

The load current of the boost converter is related to the average inductor current by the relation:

$$I_{\text{AMP}} = I_{\text{INDUCTOR(AVE)}} \times (1 - \text{DC}) \quad (9)$$

Where "DC" is the duty cycle of the application.

The switch current can be found by:

$$I_{\text{SW}} = I_{\text{INDUCTOR(AVE)}} + 1/2 (I_{\text{RIPPLE}}) \quad (10)$$

Inductor ripple current is dependent on inductance, duty cycle, supply voltage and frequency:

$$I_{\text{RIPPLE}} = \text{DC} \times (V_{\text{DD}} - V_{\text{SW}}) / (f \times L) \quad (11)$$

where f = switching frequency = 1MHz

combining all terms, we can develop an expression which allows the maximum available load current to be calculated:

$$I_{\text{AMP(max)}} = (1 - \text{DC}) \times [I_{\text{SW(max)}} - \text{DC}(V_{\text{DD}} - V_{\text{SW}})] / 2fL \quad (12)$$

The equation shown to calculate maximum load current takes into account the losses in the inductor or turn-off switching losses of the FET and diode.

DESIGN PARAMETERS V_{SW} AND I_{SW}

The value of the FET "ON" voltage (referred to as V_{SW} in equations 9 thru 12) is dependent on load current. A good approximation can be obtained by multiplying the on resistance (R_{DS(ON)}) of the FET times the average inductor current. The maximum peak switch current the device can deliver is dependent on duty cycle.

EVALUATION BOARD AND PCB LAYOUT GUIDELINES

For information on the LM48555 demo board and PCB layout guidelines refer to Application Notes (AN-1611).

Revision History

Rev	Date	Description
0.1	03/15/07	Initial Web Release

Physical Dimensions inches (millimeters) unless otherwise noted

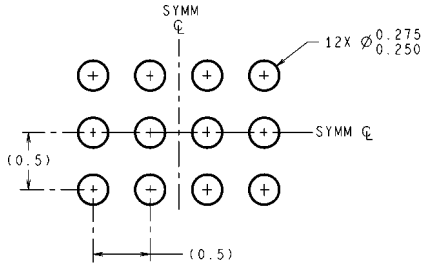

DIMENSIONS ARE IN MILLIMETERS
DIMENSIONS IN () FOR REFERENCE ONLY

LAND PATTERN RECOMMENDATION

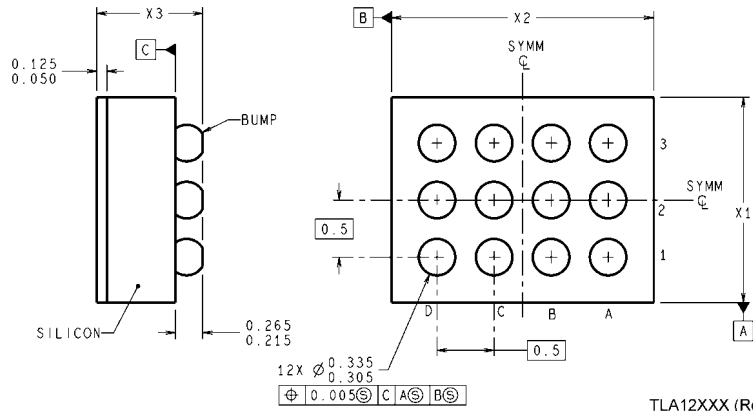
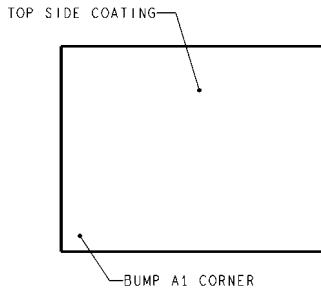

TLA12XXX (Rev C)

Thin micro SMD
Order Number LM48555TL
NS Package Number TLA12Z1A
X1 = 1.463±0.03mm X2 = 1.970±0.03mm X3 = 0.600±0.075mm

Notes

LM48555

Notes

THE CONTENTS OF THIS DOCUMENT ARE PROVIDED IN CONNECTION WITH NATIONAL SEMICONDUCTOR CORPORATION ("NATIONAL") PRODUCTS. NATIONAL MAKES NO REPRESENTATIONS OR WARRANTIES WITH RESPECT TO THE ACCURACY OR COMPLETENESS OF THE CONTENTS OF THIS PUBLICATION AND RESERVES THE RIGHT TO MAKE CHANGES TO SPECIFICATIONS AND PRODUCT DESCRIPTIONS AT ANY TIME WITHOUT NOTICE. NO LICENSE, WHETHER EXPRESS, IMPLIED, ARISING BY ESTOPPEL OR OTHERWISE, TO ANY INTELLECTUAL PROPERTY RIGHTS IS GRANTED BY THIS DOCUMENT.

TESTING AND OTHER QUALITY CONTROLS ARE USED TO THE EXTENT NATIONAL DEEMS NECESSARY TO SUPPORT NATIONAL'S PRODUCT WARRANTY. EXCEPT WHERE MANDATED BY GOVERNMENT REQUIREMENTS, TESTING OF ALL PARAMETERS OF EACH PRODUCT IS NOT NECESSARILY PERFORMED. NATIONAL ASSUMES NO LIABILITY FOR APPLICATIONS ASSISTANCE OR BUYER PRODUCT DESIGN. BUYERS ARE RESPONSIBLE FOR THEIR PRODUCTS AND APPLICATIONS USING NATIONAL COMPONENTS. PRIOR TO USING OR DISTRIBUTING ANY PRODUCTS THAT INCLUDE NATIONAL COMPONENTS, BUYERS SHOULD PROVIDE ADEQUATE DESIGN, TESTING AND OPERATING SAFEGUARDS.

EXCEPT AS PROVIDED IN NATIONAL'S TERMS AND CONDITIONS OF SALE FOR SUCH PRODUCTS, NATIONAL ASSUMES NO LIABILITY WHATSOEVER, AND NATIONAL DISCLAIMS ANY EXPRESS OR IMPLIED WARRANTY RELATING TO THE SALE AND/OR USE OF NATIONAL PRODUCTS INCLUDING LIABILITY OR WARRANTIES RELATING TO FITNESS FOR A PARTICULAR PURPOSE, MERCHANTABILITY, OR INFRINGEMENT OF ANY PATENT, COPYRIGHT OR OTHER INTELLECTUAL PROPERTY RIGHT.

LIFE SUPPORT POLICY

NATIONAL'S PRODUCTS ARE NOT AUTHORIZED FOR USE AS CRITICAL COMPONENTS IN LIFE SUPPORT DEVICES OR SYSTEMS WITHOUT THE EXPRESS PRIOR WRITTEN APPROVAL OF THE CHIEF EXECUTIVE OFFICER AND GENERAL COUNSEL OF NATIONAL SEMICONDUCTOR CORPORATION. As used herein:

Life support devices or systems are devices which (a) are intended for surgical implant into the body, or (b) support or sustain life and whose failure to perform when properly used in accordance with instructions for use provided in the labeling can be reasonably expected to result in a significant injury to the user. A critical component is any component in a life support device or system whose failure to perform can be reasonably expected to cause the failure of the life support device or system or to affect its safety or effectiveness.

National Semiconductor and the National Semiconductor logo are registered trademarks of National Semiconductor Corporation. All other brand or product names may be trademarks or registered trademarks of their respective holders.

Copyright© 2007 National Semiconductor Corporation

For the most current product information visit us at www.national.com



National Semiconductor Americas Customer Support Center
 Email: new.feedback@nsc.com
 Tel: 1-800-272-9959

National Semiconductor Europe Customer Support Center
 Fax: +49 (0) 180-530-85-86
 Email: europe.support@nsc.com
 Deutsch Tel: +49 (0) 69 9508 6208
 English Tel: +49 (0) 870 24 0 2171
 Français Tel: +33 (0) 1 41 91 8790

National Semiconductor Asia Pacific Customer Support Center
 Email: ap.support@nsc.com

National Semiconductor Japan Customer Support Center
 Fax: 81-3-5639-7507
 Email: jpn.feedback@nsc.com
 Tel: 81-3-5639-7560