

4-Character 5 x 7 Dot Matrix / RoHS Compliant - By Exemption (see page 1)

Serial Input Alphanumeric Industrial Display

Sunlight Viewable: ISD235X

ISD201X, ISD231X, ISD235X

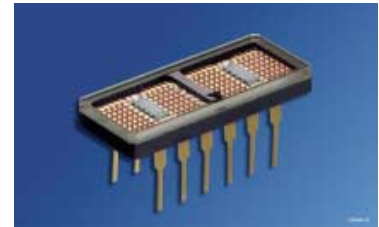
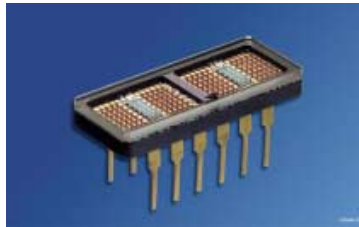

ISD201X

ISD231X

ISD235X

RoHS Compliant - By Exemption DESCRIPTION

The ISD201X/231X/235X are four digit 5 x 7 dot matrix serial input alphanumeric displays. The displays are available in red, yellow, high efficiency red, or high efficiency green. The package is a standard twelve-pin hermetic DIP with glass lens. The display can be stacked horizontally or vertically to form messages of any length.

These displays have two fourteen-bit CMOS shift registers with built-in row drivers. These shift registers drive twenty-eight rows and enable the design of customized fonts. Cascading multiple displays is possible because of the Data In and Data Out pins. Data In and Out are easily input with the clock signal and displayed in parallel on the row drivers. Data Out represents the output of the 7th bit of digit number four shift register. The shift register is level triggered. The like columns of each character in a display cluster are tied to a single pin (see Block Diagram). High true data in the shift register enables the output current mirror driver stage associated with each row of LEDs in the 5 x 7 diode array.

The TTL compatible V_B input may either be tied to V_{CC} for maximum display intensity or pulse width modulated to achieve intensity control and reduce power consumption.

In the normal mode of operation, input data for digit four, column one is loaded into the seven on-board shift register locations one through seven. Column one data for digits 3, 2 and 1 is shifted into the display shift register locations. Then column one input is enabled for an appropriate period of time, T . A similar process is repeated for columns 2, 3, 4 and 5. If the decode time and load data time into the shift register is t , then with five columns, each column of the display is operating at a duty factor of:

$$DF = \frac{T}{5(T + t)}$$

$T+t$, allotted to each display column, is generally chosen to provide the maximum duty factor consistent with the minimum refresh rate necessary to achieve a flicker free display. For most strobed display systems, each column of the display should be refreshed (turned on) at a minimum rate of 100 times per second.

With columns to be addressed, this refresh rate then gives a value for the time $T+t$ of: $1/[5 \times (100)] = 2.0$ msec. If the device is operated at 5.0 MHz clock rate maximum, it is possible to maintain $t < T$. For short display strings, the duty factor will then approach 20%.

See Appnote 44 for application information and Appnotes 18, 19, 22, 23 at www.osram-os.com

FEATURES

- Four Dot Matrix Characters
- Character Height
 - ISD201X— 3.81 mm (0.150")
 - ISD231X— 5.08 mm (0.200")
 - ISD235X— 5.08 mm (0.200")
- Built-in CMOS Shift Registers with Constant Current LED Row Drivers
- Wide Viewing Angle
- Shift Registers Allow Custom Fonts
- Easily Cascaded for Multiple Displays
- TTL Compatible
- End Stackable
- Operating Temperature Range:
 - 55°C to +100°C
- Categorized for Luminous Intensity
- Ceramic Package, Hermetically Sealed Flat Glass Window



RoHS Compliance

The ISD201X, ISD231X, ISD235X Intelligent Displays™ are hermetically sealed displays using a ceramic and glass construction. These components are not lead (Pb) free but are RoHS Compliant based on the RoHS Compliance Directive's Annex, paragraphs 5 and 7. These exemptions allow for lead (Pb) in glass and ceramic electronic components. Refer to the following excerpts from the RoHS Compliance Directive Annex:

Applications of lead, mercury, cadmium and hexavalent chromium, which are exempted from the requirements of Article 4(1)

5. Lead in glass of cathode ray tubes, electronic components and fluorescent tubes.
7. Lead in electronic ceramic parts (e.g. piezoelectric devices).

Ordering Information

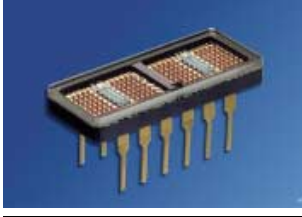
	Type	Color of Emission	Character Height mm (inch)	Ordering Code
	ISD2351 ISD2352 ISD2353	yellow high efficiency red high efficiency green	5.08 (0.200)	Q68000A8142 Q68000A8143 Q68000A8144
	ISD2010 ISD2011 ISD2012 ISD2013	red yellow high efficiency red high efficiency green	3.81 (0.150)	Q68000A8134 Q68000A8135 Q68000A8136 Q68000A8137
	ISD2310 ISD2311 ISD2312 ISD2313	red yellow high efficiency red high efficiency green	5.08 (0.200)	Q68000A8138 Q68000A8139 Q68000A8140 Q68000A8141

Maximum Ratings

Parameter	Symbol	Value	Unit
Operating temperature range ¹⁾	T_{op}	-55 to +100	°C
Storage temperature range	T_{stg}	-65 to +125	°C
Supply voltage V_{CC} to GND	V_{CC}	-0.5 to 7.0	V
Inputs, data out and V_B		-0.5 to $V_{CC} + 0.5$	V
Column input voltage	V_{COL}	-0.5 to 6.0	V
Solder temperature 1.59 mm (0.063") below seating plane, $t < 5.0$ s	T_s	260	°C
Allowable power dissipation, $T_A=25^\circ\text{C}^2)$			
ISD2010	P_{tot}	0.91	W
ISD2011 / ISD2012 / ISD2013	P_{tot}	0.86	W
ISD231X	P_{tot}	1.10	W
ISD235X	P_{tot}	1.35	W

Timing Characteristics⁴⁾

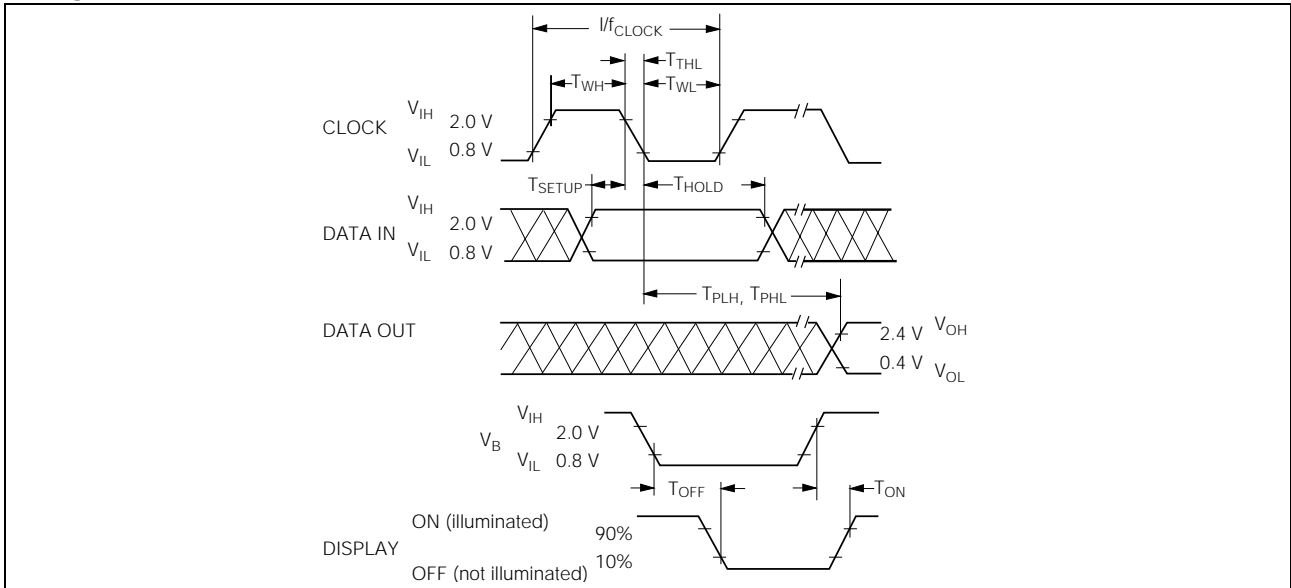

AC Electrical Characteristics

($V_{CC} = 4.75\text{ V to } 5.25\text{ V}$, $T_A = -55^\circ\text{C to } 100^\circ\text{C}$)

Symbol	Description	Min.	Typ.	Max. ⁵⁾	Units
T_{SETUP}	Setup Time	50	10	—	ns
T_{HOLD}	Hold Time	25	20	—	ns
T_{WL}	Clock Width Low	75	45	—	ns
T_{WH}	Clock Width High	75	45	—	ns
$F_{(CLK)}$	Clock Frequency	—	—	5	MHz
T_{THL} T_{TLH}	Clock Transition Time	—	75	200	ns
T_{PHL} T_{PLH}	Propagation Delay Clock to Data Out	—	50	125	ns

ISD201X³⁾
Package Outlines

Dimensions in mm (inch)

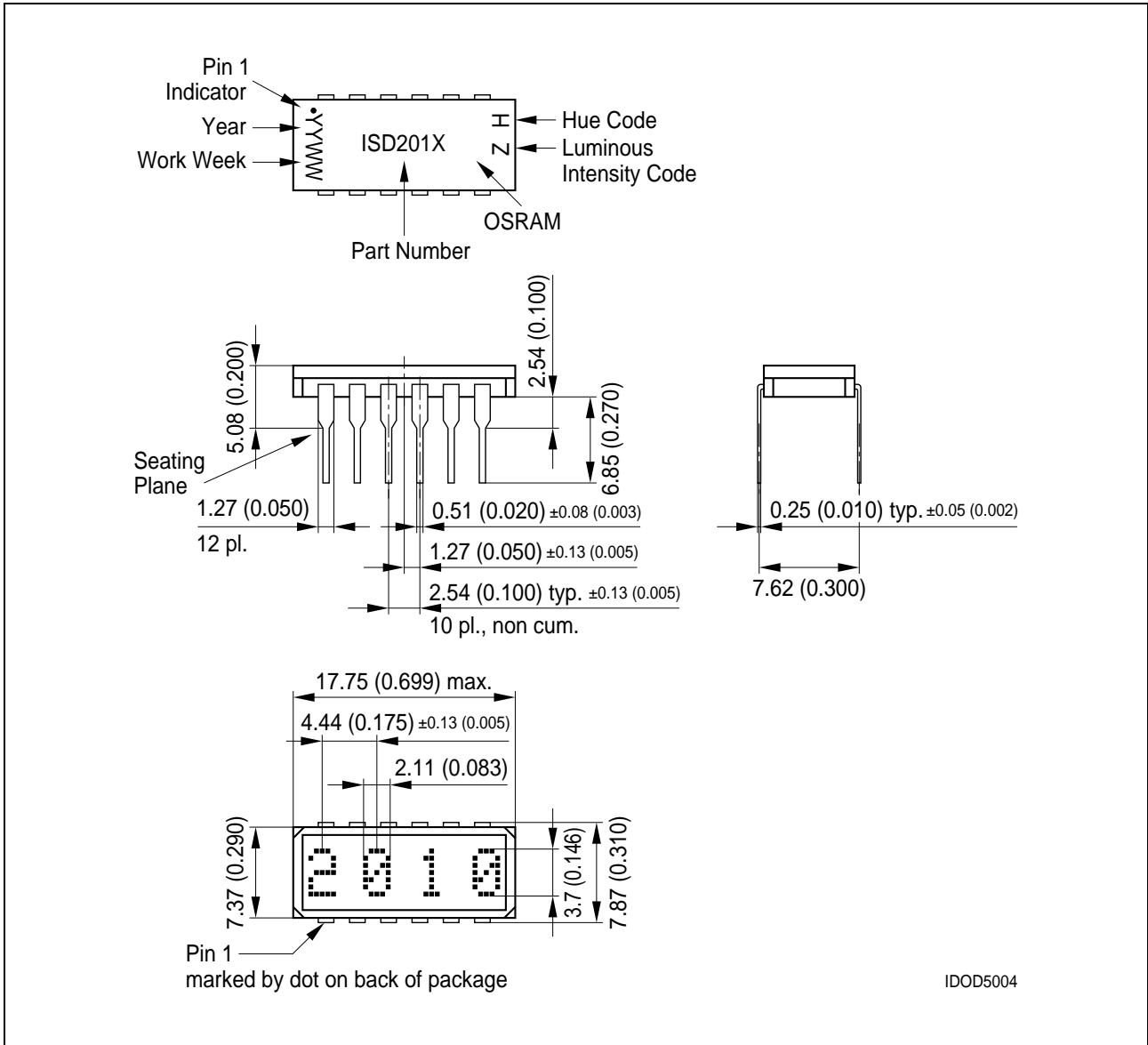

IDOD5004

ISD231X / ISD235X³⁾

Package Outlines: Dimensions in mm (inch)

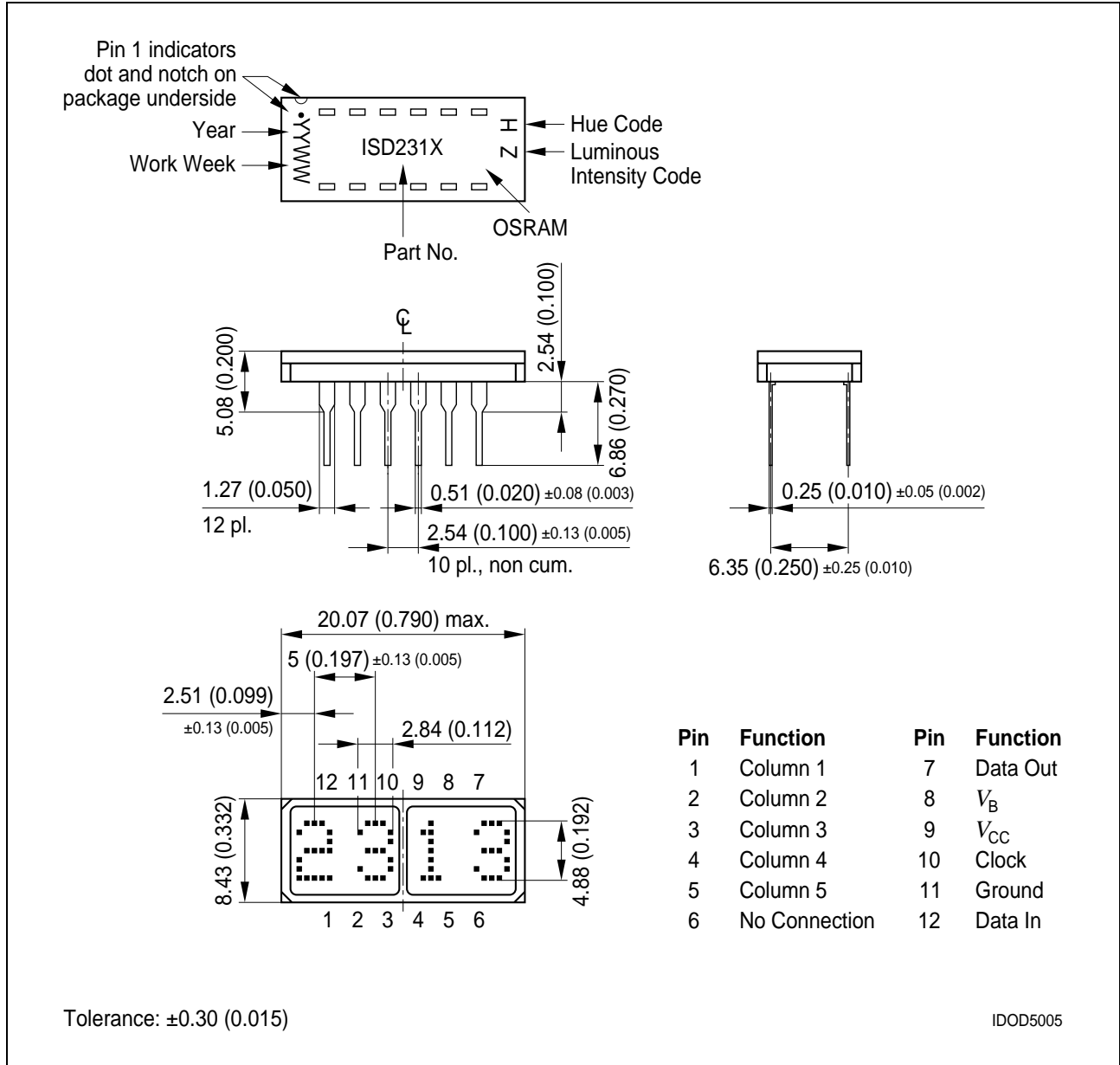

Maximum Allowable Power Dissipation vs. Temperature, ISD201X

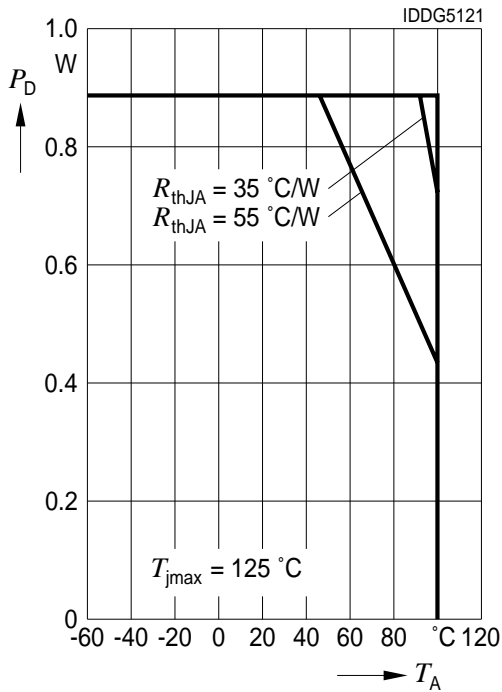

Maximum Allowable Power Dissipation vs. Temperature, ISD235X

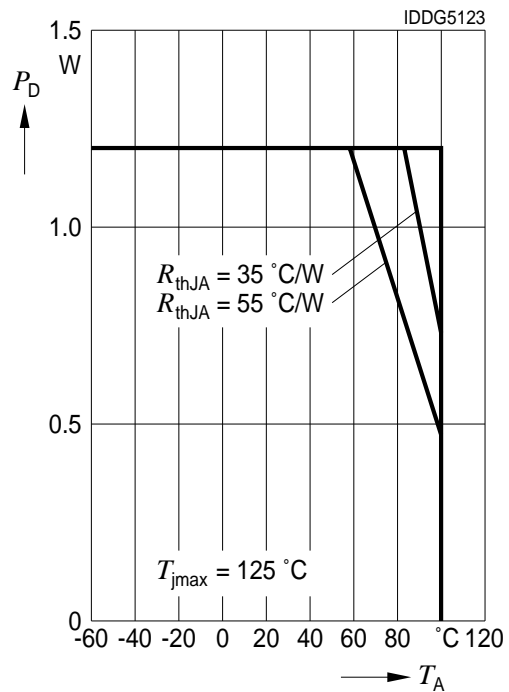

Maximum Allowable Power Dissipation vs. Temperature, ISD231X

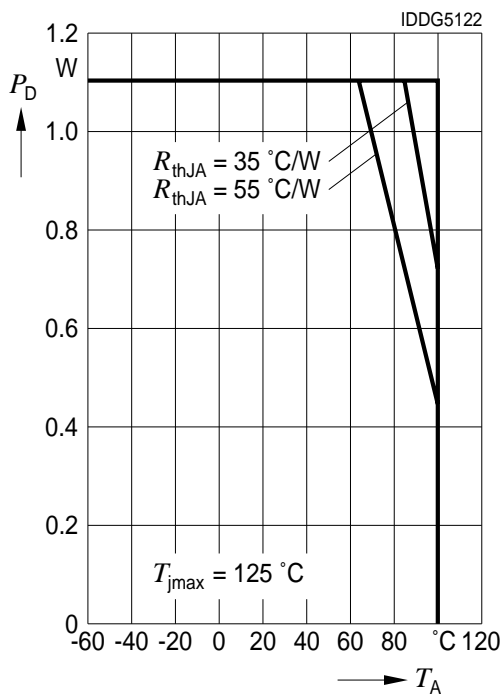

Optical Characteristics

Red ISD2010 / ISD2310

Description		Symbol	Min.	Typ. ⁹⁾	Units	Test Conditions
Peak Luminous Intensity per LED ^{6) 7)} (Character Average)	ISD2010	I_{Vpeak}	105	200	μcd	$V_{CC}=5.0\text{ V},$ $V_{COL}=3.5\text{ V},$ $T_J=25^\circ\text{C}^{10)},$ $V_B=2.4\text{ V}$
	ISD2310		220	370		
Peak Wavelength		λ_{Vpeak}	—	660	nm	—
Dominant Wavelength ⁸⁾		λ_{dom}	—	639	nm	—

Yellow ISD2011 / ISD2311 / ISD2351

Description		Symbol	Min.	Typ. ⁹⁾	Units	Test Conditions
Peak Luminous Intensity per LED ^{6) 7)} (Character Average)	ISD2011	I_{Vpeak}	400	750	μcd	$V_{CC}=5.0\text{ V},$ $V_{COL}=3.5\text{ V},$ $T_J=25^\circ\text{C}^{10)},$ $V_B=2.4\text{ V}$
	ISD2311		650	1140		
	ISD2351		2400	3400		
Peak Wavelength		λ_{Vpeak}	—	583	nm	—
Dominant Wavelength ⁸⁾		λ_{dom}	—	585	nm	—

High Efficiency Red ISD2012 / ISD2312 / ISD2352

Description		Symbol	Min.	Typ. ⁹⁾	Units	Test Conditions
Peak Luminous Intensity per LED ^{6) 7)} (Character Average)	ISD2012	I_{Vpeak}	400	1430	μcd	$V_{CC}=5.0\text{ V},$ $V_{COL}=3.5\text{ V},$ $T_J=25^\circ\text{C}^{10)},$ $V_B=2.4\text{ V}$
	ISD2312		650	1430		
	ISD2352		853	2500		
Peak Wavelength		λ_{Vpeak}	—	630	nm	—
Dominant Wavelength ⁸⁾		λ_{dom}	—	626	nm	—

High Efficiency Green ISD2013 / ISD2313 / ISD2353

Description		Symbol	Min.	Typ. ⁹⁾	Units	Test Conditions
Peak Luminous Intensity per LED ^{6) 7)} (Character Average)	ISD2013	I_{Vpeak}	850	1550	μcd	$V_{CC}=5.0\text{ V},$ $V_{COL}=3.5\text{ V},$ $T_J=25^\circ\text{C}^{10)},$ $V_B=2.4\text{ V}$
	ISD2313		1280	2410		
	ISD2353		2400	3000		
Peak Wavelength		λ_{Vpeak}	—	568	nm	—
Dominant Wavelength ⁸⁾		λ_{dom}	—	574	nm	—

Recommended Operating Conditions

(Guaranteed over operating temperature range)

Parameter	Symbol	Min.	Nom.	Max.	Units
Supply Voltage	V_{CC}	4.75	5.0	5.25	V
Data Out Current, Low State	I_{OL}	—	—	—	mA
Data Out Current, High State	I_{OH}	—	—	—	mA
Column Input Voltage, Column On*	V_{COL}	2.75	—	3.5	V
Setup Time	T_{SETUP}	70	45	—	ns
Hold Time	T_{HOLD}	30	—	—	ns
Width of Clock	$T_{W(CLK)}$	75	—	—	ns
Clock Frequency	T_{CLK}	—	—	5.0	MHz
Clock Transition Time	T_{THL}	—	—	200	ns
Free Air Operating Temperature Range	T_A	-55	—	+100	°C

* See Figures „Peak Column Current vs. Column Voltage“

Peak Column Current vs. Column Voltage, ISD201X

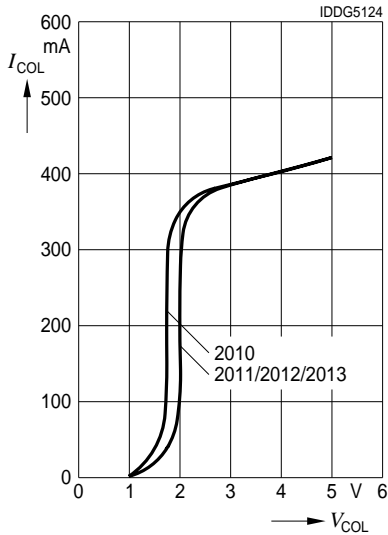

Peak Column Current vs. Column Voltage, ISD231X

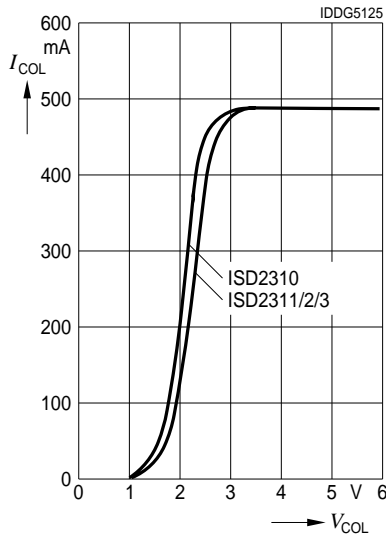

Peak Column Current vs. Column Voltage, ISD235X

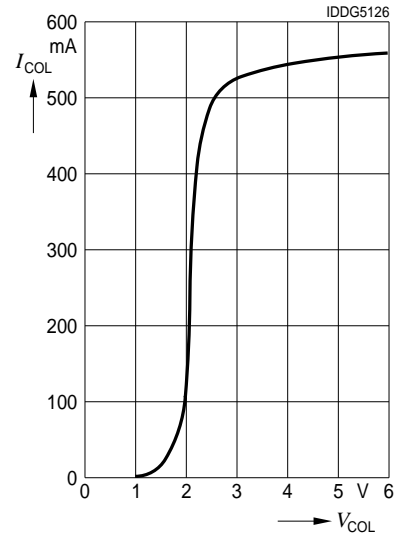

Electrical Characteristics

(-55°C to +100°C, unless otherwise specified)

Description	Symbol	Min.	Typ. ⁹⁾	Max.	Units	Test Conditions	
Supply Current (quiescent)	I_{CC}	—	—	5.0	mA	$V_B=0.4\text{ V}$	$V_{CC}=5.25\text{ V}$ $V_{CLK}=V_{DATA}=2.4\text{ V}$ All SR Stages=Logical 1
		—	—	5.0		$V_B=2.4\text{ V}$	
Supply Current (operating)	I_{CC}	—	—	10	mA	$F_{CLK}=5.0\text{ MHz}$	
Column Current at Any Column Input*	I_{COL}	—	—	10	μA	$V_B=0.4\text{ V}$	$V_{CC}=5.25\text{ V}$ $V_{COL}=3.5\text{ V}$ All SR Stages=Logical 1
Column Current at Any Column Input* ISD2010 red ISD2011/2/3: yellow, HER, green ISD231X: red, yellow, HER, green ISD235X: yellow, HER, green	I_{COL}	—	350 335 380 550	435 410 520 650	mA	—	
V_B , Clock or Data Input Threshold Low	V_{IL}	—	—	0.8	V	$V_{CC}=4.75\text{ V}-5.25\text{ V}$	
V_B , Clock or Data Input Threshold High	V_{IH}	2.0	—	—	V		
Data Out Voltage	V_{OH}	2.4	3.6	—	V	$I_{OH}=0.5\text{ mA}$	$V_{CC}=5.25\text{ V}$ $I_{COL}=0\text{ mA}$
	V_{OL}	—	—	—	—	$I_{OL}=1.6\text{ mA}$	
Input Current Logical 0, V_B only	I_{IL}	-30	-110	-300	μA	$V_{CC}=4.75\text{ V}-5.25\text{ V}$, $V_{IL}=0.8\text{ V}$	
Input Current Logical 0, Data, Clock	I_{IL}	—	—	—	—		
Power Dissipation per Package ISD201X ISD231X ISD235X	P_D	0.44 0.52 0.74	—	—	W	$V_{CC}=5.0\text{ V}$, $V_{COL}=3.5\text{ V}$, 17.5% DF 15 LEDs on per character, $V_B=2.4\text{ V}$	
Thermal Resistance IC, Junction-to-Pin ISD201X ISD231X ISD235X	R_{qJ-PIN}	—	30 20 25	—	°C/W	—	

* See Figures „Peak Column Current vs. Column Voltage“ (**page 8**)

Block Diagram

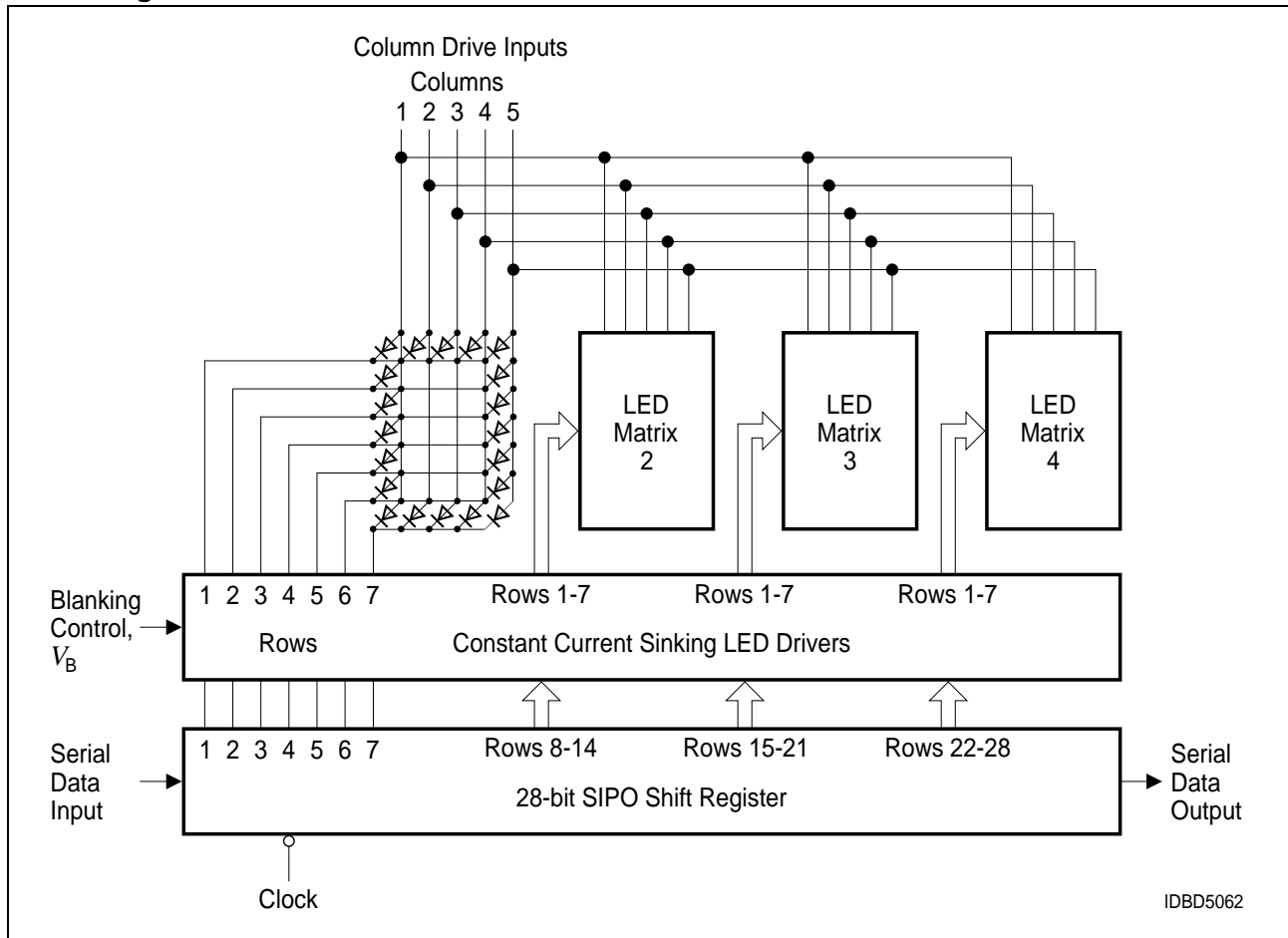

Contrast Enhancement Filters for Sunlight Readability

Display Color	Filter Color	Marks Polarized Corp.*	Optical Characteristics of Filter
Red, HER	Red	MPC 20-15C	25% at 635 nm, Circular Polarizer
Yellow	Amber	MPC 30-25C	25% at 583 nm, Circular Polarizer
Green	Yellow/Green	MPC 50-122C	22% at 568 nm, Circular Polarizer
Multiple Colors High Ambient Light	Neutral Gray	MPC 80-10C	10% Neutral, Circular Polarizer
Multiple Colors	Neutral Gray	MPC 80-37C	37% Neutral, Circular Polarizer

* Marks Polarized Corp.
 25-B Jefryn Blvd. W.
 Deer Park, NY 11729
 516/242-1300
 FAX 516/242-1347
 Marks Polarized Corp. manufactures to MIL-1-45208 inspection system.

The small alphanumeric displays are hybrid LED and CMOS assemblies that are designed for reliable operation in commercial and industrial environments. Optimum reliability and optical performance will result when the junction temperature of the LEDs and CMOS ICs are kept as low as possible.

Thermal Modeling

ISD displays consist of two driver ICs and four 5 x 7 LED matrixes. A thermal model of the display is shown in Figure „Thermal Model“. It illustrates that the junction temperature of the semiconductor = junction self heating + the case temperature rise + the ambient temperature.

Equation 1 shows this relationship.

Thermal Model

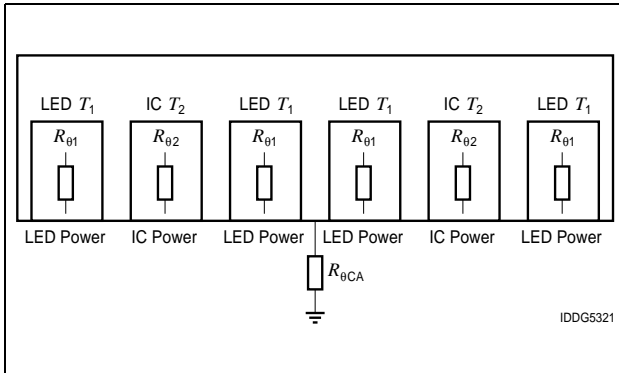

See Equation 1 below.

The junction rise within the LED is the product of the thermal impedance of an individual LED (37°C/W, DF=20%, F=200 Hz), times the forward voltage, V_{F(LED)}, and forward current I_{F(LED)}, of 13 – 14.5 mA. This rise averages T_{J(LED)}=1°C. The Table below shows the V_{F(LED)} for the respective displays.

Model Number	VF		
	Min.	Typ.	Max.
ISD2010 ISD2310	1.6	1.7	2.0
ISD2011/2/3 ISD2311/2/3 ISD2351/2/3	1.9	2.2	3.0

The junction rise within the LED driver IC is the combination of the power dissipated by the IC quiescent current and the 28 row driver current sinks. The IC junction rise is given in Equation 2.

Equation 1.

$$T_{J(LED)} = P_{LED} Z_{\theta JC} + P_{CASE} (R_{\theta JC} + R_{\theta CA}) + T_A$$

$$T_{J(LED)} = [(I_{COL} / 28) V_{F(LED)} Z_{\theta JC}] + [(n/35) I_{COL} DF (5V_{COL}) + V_{CC} I_{CC}] \cdot [R_{\theta JC} + R_{\theta CA}] + T_A$$

Equation 2.

$$T_{J(IC)} = P_{COL} (R_{\theta JC} + R_{\theta CA}) + T_A$$

$$T_{J(IC)} = [5(V_{COL} - V_{F(LED)}) \cdot (I_{COL} / 2) \cdot (n/35) DF + V_{CC} \cdot I_{CC}] \cdot [R_{\theta JC} + R_{\theta CA}] + T_A$$

A thermal resistance of 28°C/W results in a typical junction rise of 6°C.

See Equation 2 below.

For ease of calculations the maximum allowable electrical operating condition is dependent upon the aggregate thermal resistance of the LED matrixes and the two driver ICs. All of the thermal management calculations are based upon the parallel combination of these two networks which is 15°C/W. Maximum allowable power dissipation is given in Equation 3.

Equation 3.

$$P_{DISPLAY} = \frac{T_{J(MAX)} - T_A}{R_{\theta JC} + R_{\theta CA}}$$

$$P_{DISPLAY} = 5V_{COL} I_{COL} (n/35) DF + V_{CC} I_{CC}$$

For further reference see Figures „Maximum Allowable Power Dissipation vs. Temperature“ (page 6) and Figures from page 12 on.

Key to equation symbols

- DF Duty factor
- I_{CC} Quiescent IC current
- I_{COL} Column current
- n Number of LEDs on in a 5 x 7 array
- P_{CASE} Package power dissipation excluding LED under consideration
- P_{COL} Power dissipation of a column
- P_{DISPLAY} Power dissipation of the display
- P_{LED} Power dissipation of a LED
- R_{qCA} Thermal resistance case to ambient
- R_{qJC} Thermal resistance junction to case
- T_A Ambient temperature
- T_{J(IC)} Junction temperature of an IC
- T_{J(LED)} Junction temperature of a LED
- T_{J(MAX)} Maximum junction temperature
- V_{CC} IC voltage
- V_{COL} Column voltage
- V_{F(LED)} Forward voltage of LED
- Z_{qJC} Thermal impedance junction to case

Optical Considerations

The light output of the LEDs is inversely related to the LED diode's junction temperature as shown in „Normalized Luminous Intensity vs. Junction Temperature“ (page 12). For optimum light output, keep the thermal resistance of the socket or PC board as low as possible.

Normalized Luminous Intensity vs. Junction Temperature

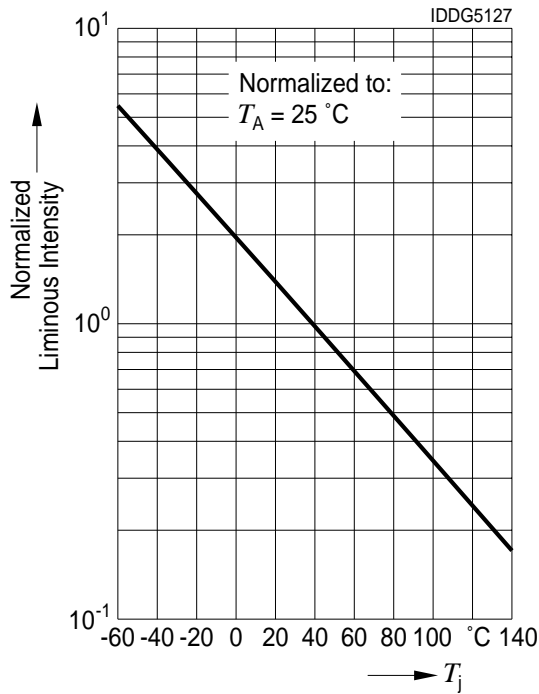

When mounted in a 10 °C/W socket and operated at Absolute Maximum Electrical conditions, the display will show an LED junction rise of 17 °C. If $T_A=40$ °C, then the LED's T_J will be 57 °C. Under these conditions the following Figure „Max. LED Junction Temperature vs. Socket Thermal Resistance“ shows that the I_V will be 75% of its 25 °C value.

Max. LED Junction Temperature vs. Socket Thermal Resistance

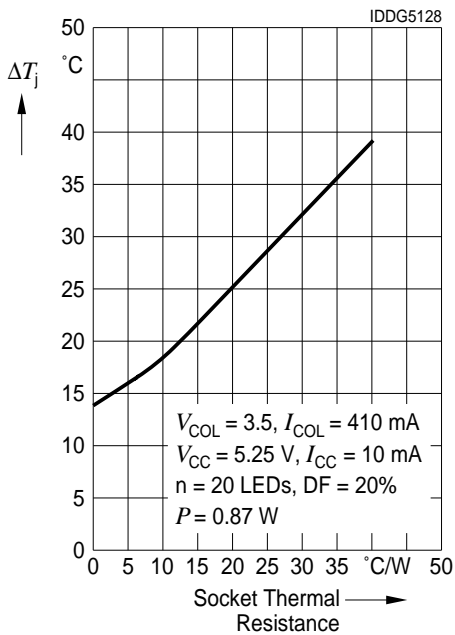

Max. Package Power Dissipation, ISD201X

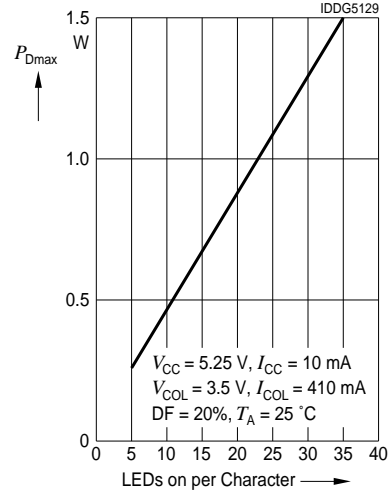

Max. Package Power Dissipation, ISD231X

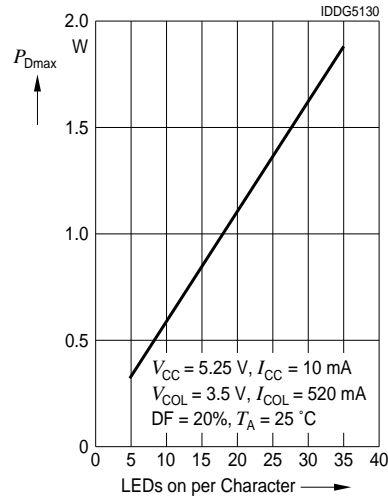

Max. Package Power Dissipation, ISD235X

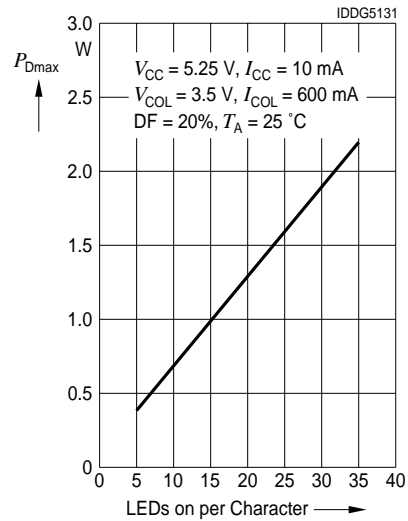

Package Power Dissipation, ISD201X

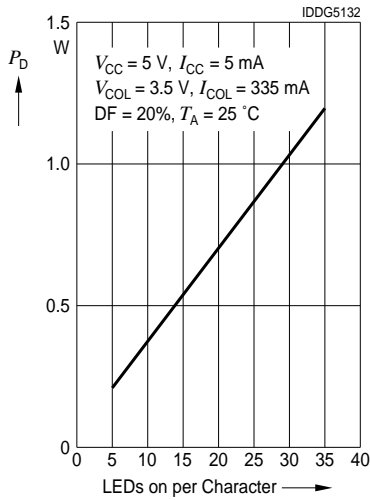

Max. Character Power Dissipation, ISD201X

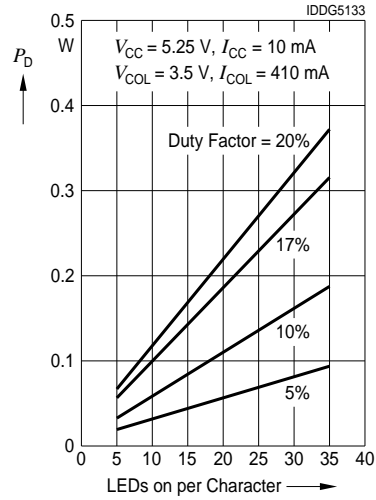

Package Power Dissipation, ISD231X

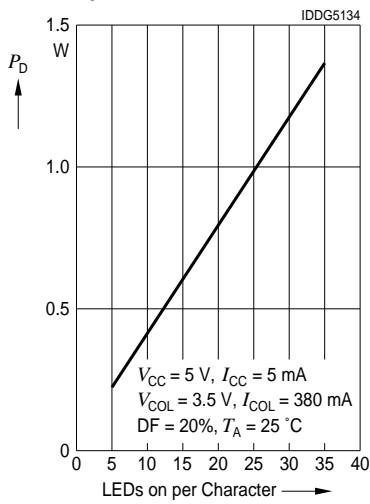

Max. Character Power Dissipation, ISD231X

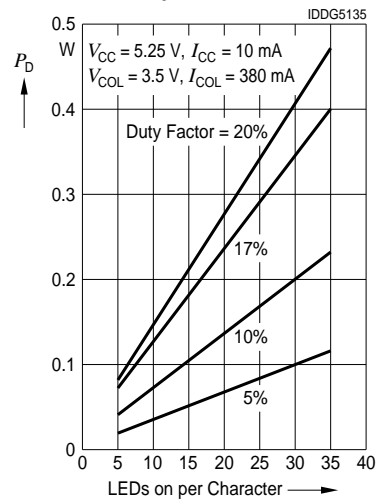

Package Power Dissipation, ISD235X

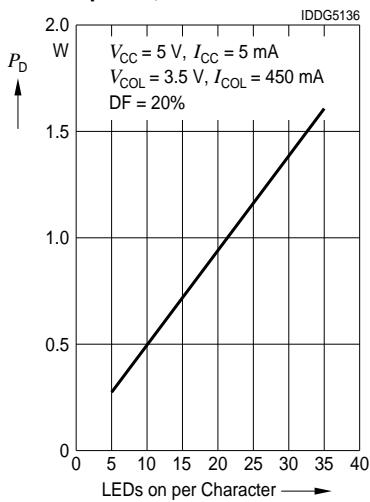

Max. Character Power Dissipation, ISD235X

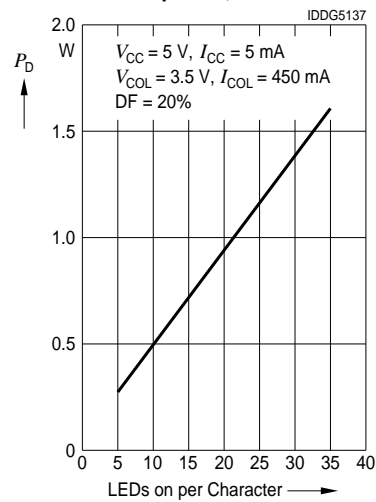

Character Power Dissipation, ISD201X

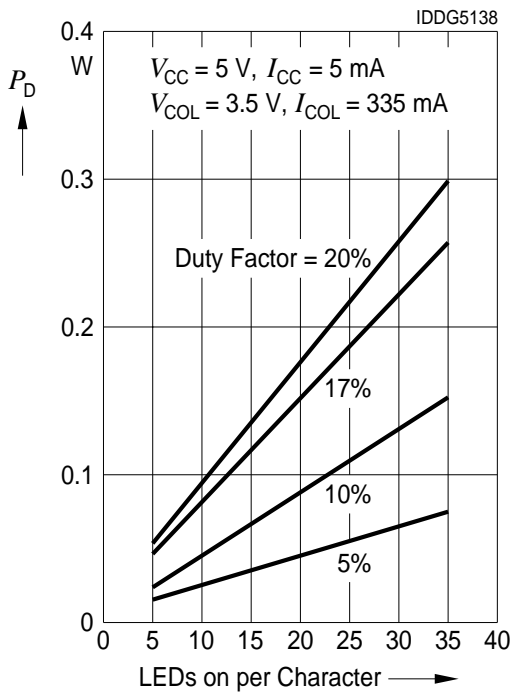

Character Power Dissipation, ISD235X

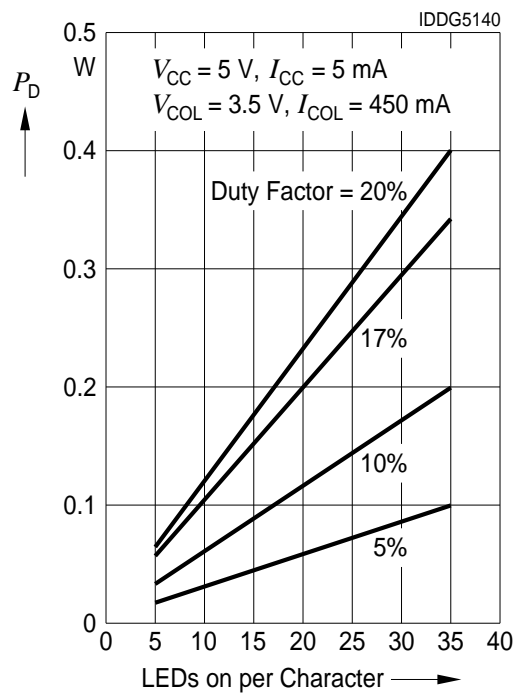

Character Power Dissipation, ISD231X

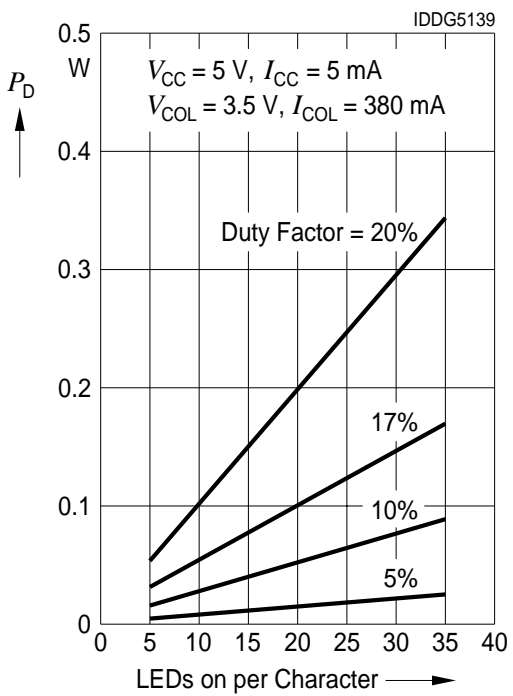

Revision History: 2006-04-04

Previous Version: 2004-12-09

Page	Subjects (major changes since last revision)	Date of change
all	RoHS Compliant - By Exemption	2006-03-03

Attention please!

The information describes the type of component and shall not be considered as assured characteristics. Terms of delivery and rights to change design reserved. Due to technical requirements components may contain dangerous substances. For information on the types in question please contact our Sales Organization. If printed or downloaded, please find the latest version in the Internet.

Packing

Please use the recycling operators known to you. We can also help you – get in touch with your nearest sales office. By agreement we will take packing material back, if it is sorted. You must bear the costs of transport. For packing material that is returned to us unsorted or which we are not obliged to accept, we shall have to invoice you for any costs incurred.

Components used in life-support devices or systems must be expressly authorized for such purpose! Critical components^{11) page 16} may only be used in life-support devices or systems^{12) page 16} with the express written approval of OSRAM OS.

2006-04-04

15

Remarks:

- 1) Operation above +100°C ambient is possible if the following conditions are met.
The junction should not exceed $T_J=125^\circ\text{C}$ and the case temperature (as measured at pin 1 or the back of the display) should not exceed $T_C=100^\circ\text{C}$.
- 2) Maximum allowable dissipation is derived from:
 $V_{CC}=5.25\text{ V}$, $V_B=2.4\text{ V}$, $V_{COL}=3.5\text{ V}$ 20 LEDs on per character, 20% DF.
- 3) Dimensions are specified as follows: inch (mm)
- 4) V_B Pulse Width Frequency—50 kHz (max.)
- 5) All typical values specified at $V_{CC}=5.0\text{ V}$ and $T_A=25^\circ\text{C}$ unless otherwise noted.
- 6) The displays are categorized for luminous intensity with the intensity category designated by a letter code on the bottom of the package.
- 7) The luminous sterance of the LED may be calculated using the following relationships:
 $L_V (\text{cd/m}^2) = I_V (\text{Candela})/A (\text{Meter})^2$
 $L_V (\text{Footlamberts}) = \rho I_V (\text{Candela})/A (\text{Foot})^2$
 $A=5.3 \times 10^{-8} \text{ m}^2 = 5.8 \times 10^{-7} (\text{Foot})^2$
- 8) Dominant wavelength (I_{dom}) is derived from the CIE chromaticity diagram and represents the single wavelength which defines the color of the device.
- 9) All typical values specified at $V_{CC}=5.0\text{ V}$ and $T_A=25^\circ\text{C}$ unless otherwise noted.
- 10) The luminous intensity is measured at $T_A=T_J=25^\circ\text{C}$. No time is allowed for the device to warm up prior to measurement.
- 11) A critical component is a component used in a life-support device or system whose failure can reasonably be expected to cause the failure of that life-support device or system, or to affect its safety or the effectiveness of that device or system.
- 12) Life support devices or systems are intended
 - (a) to be implanted in the human body,
 - or
 - (b) to support and/or maintain and sustain human life.If they fail, it is reasonable to assume that the health or the life of the user may be endangered.

Published by
OSRAM Opto Semiconductors GmbH
Wernerwerkstrasse 2, D-93049 Regensburg
www.osram-os.com
© All Rights Reserved.

2006-04-04

16