

1. PART NO. EXPRESSION :

$\frac{P}{(a)} \frac{S}{(b)} \frac{B}{(c)} \frac{0}{(d)} \frac{7}{(e)} \frac{0}{(f)} \frac{5}{(f)} \frac{1}{(f)} \frac{R}{(f)} \frac{0}{(f)} \frac{M}{(f)} \frac{Z}{(f)} \frac{F}{(f)}$

- (a) Series code
- (b) Dimension code
- (c) Inductance code : 1R0 = 1.0uH
- (d) Tolerance code : K = $\pm 10\%$, L = $\pm 15\%$, M = $\pm 20\%$
- (e) X, Y, Z : Standard part
- (f) F : Lead Free

2. CONFIGURATION & DIMENSIONS :

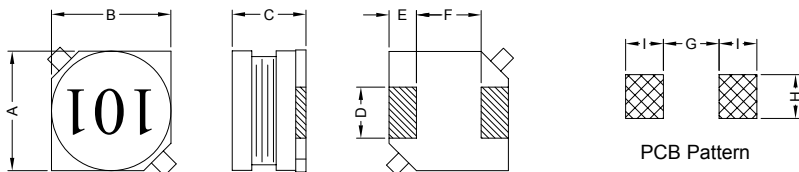

Unit:m/m

A	B	C	D	E	F	G	H	I
7.0 \pm 0.3	7.0 \pm 0.3	4.6 \pm 0.3	2.0 \pm 0.2	1.5 \pm 0.2	4.0 \pm 0.2	3.7 Ref.	2.2 Ref.	1.9 Ref.

3. SCHEMATIC :



4. MATERIALS :

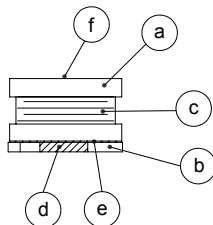

- (a) Core : DR Ferrite Core
- (b) Base : LCP
- (c) Wire : Enamelled Copper Wire
- (d) Terminal : Tinned Copper Plate
- (e) Adhesive : Epoxy
- (f) Ink : Bon Margue

5. GENERAL SPECIFICATION :

- a) Temp. rise : 40°C Max.
- b) Rated current : Base on temp. rise & $\Delta L/L0A = 10\%$ Max.
- c) Storage temp. : -40°C to +125°C
- d) Operating temp. : -40°C to +85°C
- e) Resistance to solder heat : 260°C.10 secs



RoHS Compliant

NOTE : Specifications subject to change without notice. Please check our website for latest information.

05.05.2008



SUPERWORLD ELECTRONICS (S) PTE LTD

PG. 1

6. ELECTRICAL CHARACTERISTICS :

Part No.	Inductance (μ H)	Test Frequency (Hz)	RDC (m Ω) Max.	IDC (A) Max.
PSB07051R0MZF	1.0 \pm 20%	1V / 100K	23	3.50
PSB07051R5MZF	1.5 \pm 20%	1V / 100K	28	3.20
PSB07052R2MZF	2.2 \pm 20%	1V / 100K	33	3.00
PSB07053R3MZF	3.3 \pm 20%	1V / 100K	40	2.70
PSB07054R7MZF	4.7 \pm 20%	1V / 100K	50	2.50
PSB07056R8MZF	6.8 \pm 20%	1V / 100K	60	2.20
PSB0705100MZF	10.0 \pm 20%	1V / 100K	75	2.00
PSB0705120MZF	12.0 \pm 20%	1V / 100K	85	1.90
PSB0705150LZF	15.0 \pm 15%	1V / 100K	90	1.50
PSB0705180LZF	18.0 \pm 15%	1V / 100K	100	1.40
PSB0705220LZF	22.0 \pm 15%	1V / 100K	120	1.30
PSB0705270LZF	27.0 \pm 15%	1V / 100K	150	1.20
PSB0705330LZF	33.0 \pm 15%	1V / 100K	180	1.10
PSB0705390LZF	39.0 \pm 15%	1V / 100K	190	1.00
PSB0705470LZF	47.0 \pm 15%	1V / 100K	220	0.90
PSB0705560KZF	56.0 \pm 10%	1V / 100K	250	0.85
PSB0705680KZF	68.0 \pm 10%	1V / 100K	270	0.80
PSB0705820KZF	82.0 \pm 10%	1V / 100K	380	0.70
PSB0705101KZF	100.0 \pm 10%	1V / 100K	420	0.65
PSB0705121KZF	120.0 \pm 10%	1V / 100K	520	0.60
PSB0705151KZF	150.0 \pm 10%	1V / 100K	580	0.50
PSB0705181KZF	180.0 \pm 10%	1V / 100K	650	0.45
PSB0705221KZF	220.0 \pm 10%	1V / 100K	880	0.40
PSB0705271KZF	270.0 \pm 10%	1V / 100K	990	0.35
PSB0705331KZF	330.0 \pm 10%	1V / 100K	1100	0.32
PSB0705391KZF	390.0 \pm 10%	1V / 100K	1400	0.30
PSB0705471KZF	470.0 \pm 10%	1V / 100K	1900	0.28
PSB0705561KZF	560.0 \pm 10%	1V / 100K	2200	0.25
PSB0705681KZF	680.0 \pm 10%	1V / 100K	2500	0.22
PSB0705821KZF	820.0 \pm 10%	1V / 100K	2900	0.20
PSB0705102KZF	1000.0 \pm 10%	1V / 100K	4000	0.18



RoHS Compliant

NOTE : Specifications subject to change without notice. Please check our website for latest information.

05.05.2008



SUPERWORLD ELECTRONICS (S) PTE LTD

PG. 2

7. CHARACTERISTICS CURVES :

@ TEMP. RISE VS. DC SUPERPOSITION RESPONSE CURVE

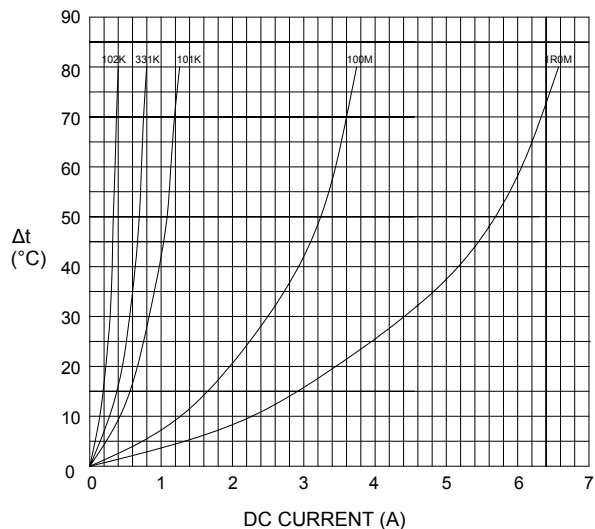

@ INDUCTANCE VS. FREQUENCY RESPONSE CURVE

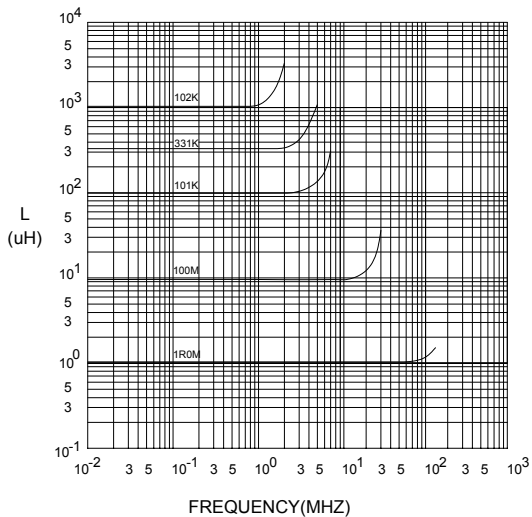

@ INDUCTANCE VS. DC SUPERPOSITION RESPONSE CURVE

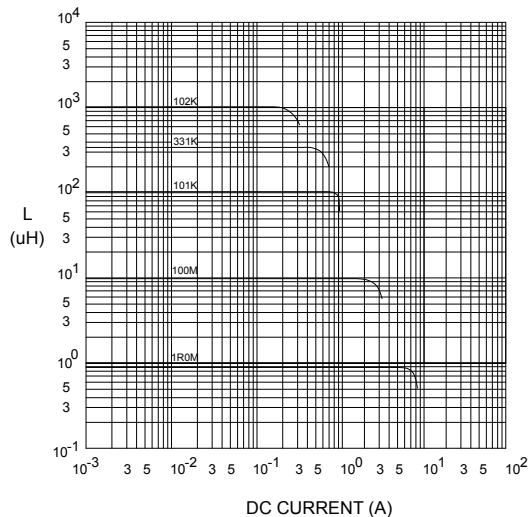

NOTE : Specifications subject to change without notice. Please check our website for latest information.



RoHS Compliant

05.05.2008



SUPERWORLD ELECTRONICS (S) PTE LTD

PG. 3

RECOMMENDED SOLDERING CONDITIONS REFLOW SOLDERINGS

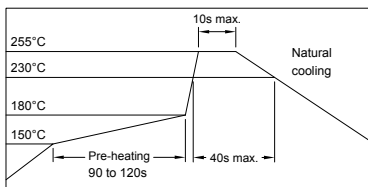

8. PACKAGING INFORMATION :

(1) CONFIGURATION

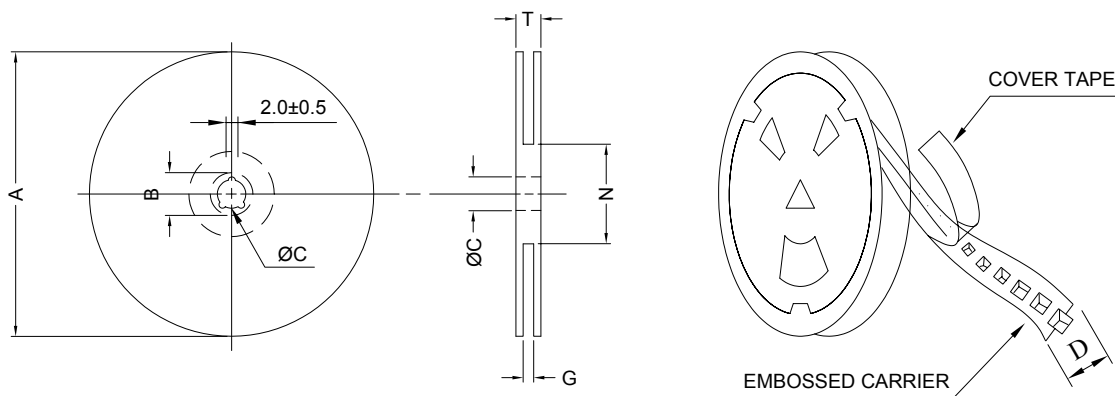

* CARRIER TAPE WIDTH : D

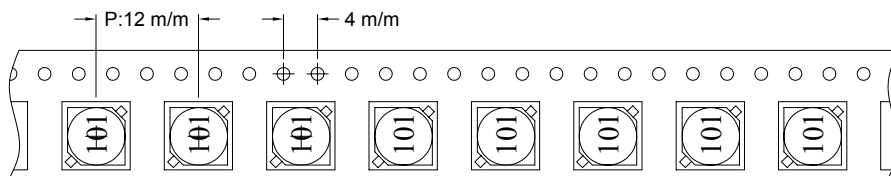

(2) DIMENSIONS

Unit:m/m

STYLE	A	B	C	D	G	N	T
13-16	330	21±0.8	13	16	18 ⁺⁰	50 ⁻⁰	22.4

(3) Q'TY & G.W. PER PACKAGE

SERIES	INNER : REEL			OUTER : CARTON		
	Q'TY (PCS)	G.W. (gw)	STYLE	Q'TY (PCS)	G.W. (Kg)	SIZE (cm)
PSB0705	1000	680	13-16	6000	7.6	40 x 40 x 24



RoHS Compliant

NOTE : Specifications subject to change without notice. Please check our website for latest information.

05.05.2008

9. RELIABILITY AND TEST CONDITION :

TEST ITEM	SPECIFICATION	TEST CONDITION
SOLDERABILITY	MORE THAN 90% OF THE TERMINAL ELECTRODE SHALL BE COVERED WITH FRESH SOLDER.	PREHEAT : 125±25°C FOR 60 SECONDS SOLDER : 99%Sn/0.3%Ag/0.7%Cu OR EQUIVALENT SOLDER TEMP. : 245±5°C FLUX : ROSIN DIP TIME : 4±1 SECONDS
THERMAL SHOCK TEST (TEMP. CYCLE)	INDUCTANCE SHALL NOT CHANGE MORE THAN ±20%	ROOM TEMP. → -25±2°C 15 MINUTES 30 MINUTES ROOM TEMP. → 85±2°C 15 MINUTES 30 MINUTES TOTAL : 50 CYCLES
HUMIDITY RESISTANCE TEST		TEMPERATURE : 40±2°C HUMIDITY : 90 ~ 95% APPLIED CURRENT : PER SPEC. TIME : 500 HOURS
HIGH TEMP. RESISTANCE TEST		TEMPERATURE : 85±2°C APPLIED CURRENT : PER SPEC. TIME : 500 HOURS



RoHS Compliant

NOTE : Specifications subject to change without notice. Please check our website for latest information.

05.05.2008



SUPERWORLD ELECTRONICS (S) PTE LTD

PG. 5

10. UL CARD :

OBMW2 **November 30, 2000**
Magnet Wire - Component
PACIFIC ELECTRIC WIRE & CABLE (SHENZHEN) CO LTD **E201757**
607 BAOLONG INDUSTRIAL ESTATE LONGGANG, SHENZHEN
GUANGDONG CHINA

Mtl Dsg	Coating Type	TC	ANSI Type	TI
UEW/U	BC Polyurethane	—	—	130
PEW/U	Polyester	—	MW5-C	155°C
PEWH/U	Modified Polyester	—	MW30-C	180
PEW-NY/U	Polyester	Polyamide	MW24-C	155
HAI/U	Polyester(Amide)(Imide)	Polyamideimide	MW35,73	200
UEW-NY/U	Polyurethane	Polyamide	MW80-C	155
			MW28-C	130

Marking: Company name and material designation or marked designation on package or reel, and Recognized Component Mark.

See General Information Preceding These Recognitions

1/3/2001 Underwriters Laboratories Inc. Card 1 of 2

SUMITOMO CHEMICAL CO LTD **E54705 (M)**
5-33 KITAHAMA 4-CHOME CHUO-KO, OSAKA JAPAN

Mtl Dsg	Col	Min Thk mm	UL94 Flame Class	Elec	RTI		w/o Imp	H W I	H A I	H V T R	D 4 5	C T I
					with Imp	Mech						
Liquid crystal polyester (LCP), designated "EKONOL" or "SUMIKASUPER", furnished in the form of pellets, (Contd)												
E4008 , E400X	NC , BK	0.30	94V-0	130	130	130	—	—	—	—	—	—
		0.75	94V-0	130	130	130	3	4	—	—	—	—
		1.5	94V-0	130	130	130	2	4	—	—	—	—
E4008	NC , WT , BK	3.0	94V-0	130	130	130	1	4	0	5	4	—
		0.30	94V-0	130	130	130	—	—	—	—	—	—
		0.75	94V-0	220	180	220	3	4	—	—	—	—
		1.5	94V-0	220	200	240	2	4	—	—	—	—
E4010	NC , BK	3.0	94V-0	220	200	240	1	4	0	5	4	—
		0.30	94V-0	130	130	130	—	—	—	—	—	—
		0.75	94V-0	220	180	220	3	4	—	—	—	—
E400(Y)L , E4008L	NC , BK	1.5	94V-0	220	200	240	2	4	—	—	—	—
		3.0	94V-0	220	200	240	1	4	0	5	4	—
		0.30	94V-0	130	130	130	—	—	—	—	—	—
E4810	NC , BK	0.75	94V-0	130	130	130	3	4	—	—	—	—
		1.5	94V-0	130	130	130	2	4	—	—	—	—
		3.0	94V-0	130	130	130	1	4	0	5	4	—
		0.30	94V-0	130	130	130	—	—	—	—	—	—
		0.75	94V-0	130	130	130	0	4	—	—	—	—
		1.5	94V-0	130	130	130	0	4	—	—	—	—
		3.0	94V-0	130	130	130	1	4	0	5	4	—
		0.30	94V-0	130	130	130	1	4	0	5	4	—

(X) Denotes any number 1 thru 9.
(Y) Denotes any number 1 thru 7.



RoHS Compliant

NOTE : Specifications subject to change without notice. Please check our website for latest information.

05.05.2008