

### 1. PART NO. EXPRESSION :

PSB0602101MZ F  
 (a) (b) (c) (d)(e)(f)

- (a) Series code
- (b) Dimension code
- (c) Inductance code : 101 = 100uH
- (d) Tolerance code : M =  $\pm 20\%$
- (e) X, Y, Z : Standard part
- (f) F : Lead Free

### 2. CONFIGURATION & DIMENSIONS :

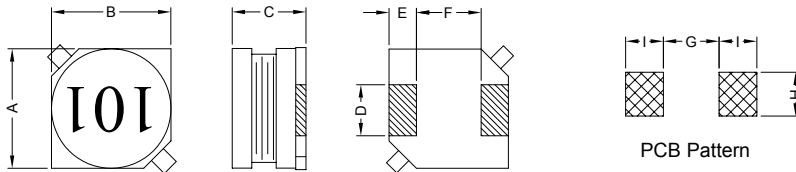

Unit:m/m

A	B	C	D	E	F	G	H	I
6.0 $\pm$ 0.3	6.0 $\pm$ 0.3	2.5 Max.	2.0 $\pm$ 0.2	1.5 $\pm$ 0.2	3.0 $\pm$ 0.2	2.8 Ref.	2.2 Ref.	1.9 Ref.

### 3. SCHEMATIC :

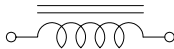

### 4. MATERIALS :

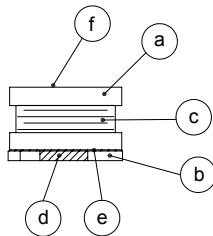

- (a) Core : DR Ferrite Core
- (b) Base : LCP
- (c) Wire : Enamelled Copper Wire
- (d) Terminal : Tinned Copper Plate
- (e) Adhesive : Epoxy
- (f) Ink : Bon Margue

### 5. GENERAL SPECIFICATION :

- a) Temp. rise : 40°C Max.
- b) Rated current : Base on temp. rise &  $\Delta L/L0A = 10\%$  Max.
- c) Storage temp. : -40°C to +125°C
- d) Operating temp. : -40°C to +85°C
- e) Resistance to solder heat : 260°C.10 secs



**RoHS Compliant**

NOTE : Specifications subject to change without notice. Please check our website for latest information.

05.05.2008



**SUPERWORLD ELECTRONICS (S) PTE LTD**

PG. 1

## 6. ELECTRICAL CHARACTERISTICS :

Part No.	Inductance ( $\mu$ H)	Test Frequency ( Hz )	RDC ( m $\Omega$ ) Max.	IDC ( A )
PSB06021R0MZF	1.0 $\pm$ 20%	1V/100K	25	2.70
PSB06021R5MZF	1.5 $\pm$ 20%	1V/100K	35	2.50
PSB06022R2MZF	2.2 $\pm$ 20%	1V/100K	40	2.00
PSB06023R3MZF	3.3 $\pm$ 20%	1V/100K	50	1.50
PSB06024R7MZF	4.7 $\pm$ 20%	1V/100K	70	1.45
PSB06026R8MZF	6.8 $\pm$ 20%	1V/100K	95	1.10
PSB0602100MZF	10.0 $\pm$ 20%	1V/100K	135	0.90
PSB0602150MZF	15.0 $\pm$ 20%	1V/100K	190	0.75
PSB0602220MZF	22.0 $\pm$ 20%	1V/100K	250	0.60
PSB0602330MZF	33.0 $\pm$ 20%	1V/100K	350	0.50
PSB0602470MZF	47.0 $\pm$ 20%	1V/100K	530	0.40
PSB0602680MZF	68.0 $\pm$ 20%	1V/100K	700	0.30
PSB0602Z101MZF	100.0 $\pm$ 20%	1V/100K	1050	0.25
PSB0602151MZF	150.0 $\pm$ 20%	1V/100K	1650	0.20
PSB0602221MZF	220.0 $\pm$ 20%	1V/100K	2200	0.18
PSB0602331MZF	330.0 $\pm$ 20%	1V/100K	3300	0.15
PSB0602471MZF	470.0 $\pm$ 20%	1V/100K	5300	0.12
PSB0602681MZF	680.0 $\pm$ 20%	1V/100K	6900	0.11
PSB0602102MZF	1000.0 $\pm$ 20%	1V/100K	10000	0.09



RoHS Compliant

NOTE : Specifications subject to change without notice. Please check our website for latest information.

05.05.2008



SUPERWORLD ELECTRONICS (S) PTE LTD

PG. 2

## 7. CHARACTERISTICS CURVES :

@ TEMP. RISE VS. DC SUPERPOSITION RESPONSE CURVE

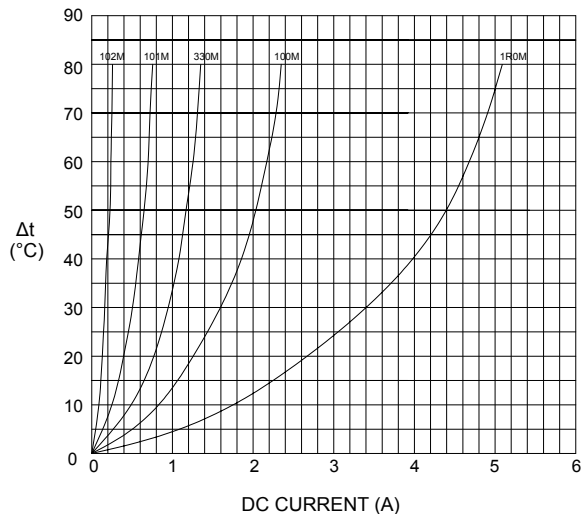

@ INDUCTANCE VS. FREQUENCY RESPONSE CURVE

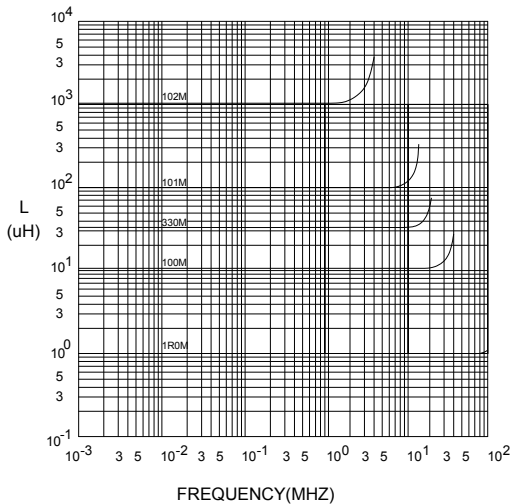

@ INDUCTANCE VS. DC SUPERPOSITION RESPONSE CURVE

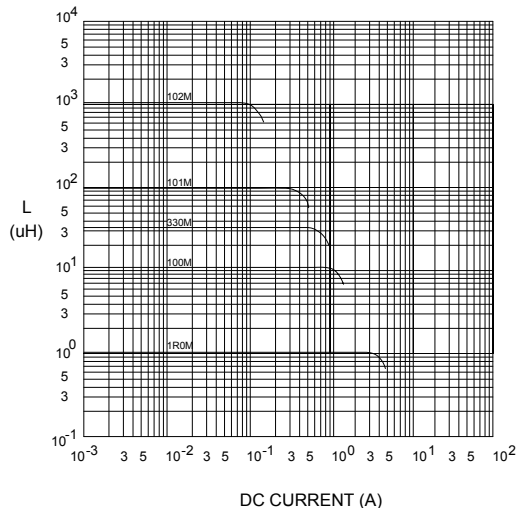

NOTE : Specifications subject to change without notice. Please check our website for latest information.



**RoHS Compliant**

05.05.2008



**SUPERWORLD ELECTRONICS (S) PTE LTD**

### RECOMMENDED SOLDERING CONDITIONS REFLOW SOLDERINGS

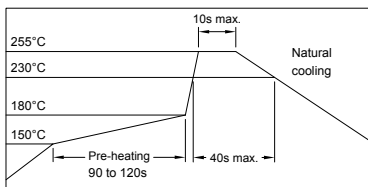

### 8. PACKAGING INFORMATION :

#### ( 1 ) CONFIGURATION

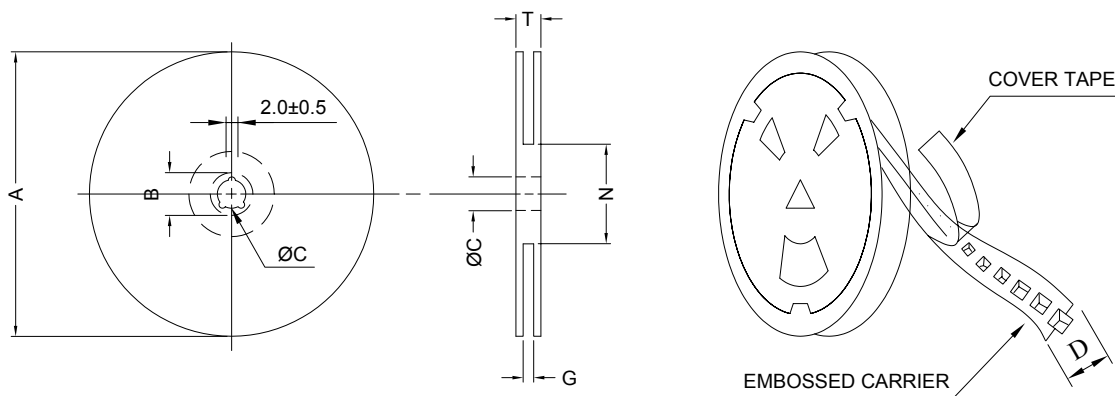

\* CARRIER TAPE WIDTH : D

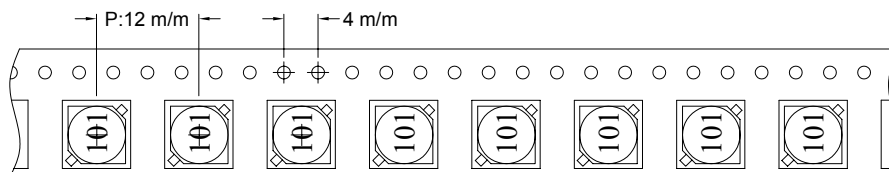

#### ( 2 ) DIMENSIONS

Unit:m/m

STYLE	A	B	C	D	G	N	T
13-16	330	21±0.8	13	16	18 <sup>+0</sup>	50 <sup>-0</sup>	22.4

#### ( 3 ) Q'TY & G.W. PER PACKAGE

SERIES	INNER : REEL			OUTER : CARTON		
	Q'TY (PCS)	G.W. (gw)	STYLE	Q'TY (PCS)	G.W. (Kg)	SIZE (cm)
PSB0602	1500	540	13-16	9000	6.8	40 x 40 x 24



**RoHS Compliant**

NOTE : Specifications subject to change without notice. Please check our website for latest information.

05.05.2008

### 9. RELIABILITY AND TEST CONDITION :

TEST ITEM	SPECIFICATION	TEST CONDITION
SOLDERABILITY	MORE THAN 90% OF THE TERMINAL ELECTRODE SHALL BE COVERED WITH FRESH SOLDER.	PREHEAT : 125±25°C FOR 60 SECONDS SOLDER : 99%Sn/0.3%Ag/0.7%Cu OR EQUIVALENT SOLDER TEMP. : 245±5°C FLUX : ROSIN DIP TIME : 4±1 SECONDS
THERMAL SHOCK TEST  ( TEMP. CYCLE )	INDUCTANCE SHALL NOT CHANGE MORE THAN ±20%	ROOM TEMP.      →      -25±2°C 15 MINUTES                      30 MINUTES  ROOM TEMP.      →      85±2°C 15 MINUTES                      30 MINUTES  TOTAL : 50 CYCLES
HUMIDITY RESISTANCE TEST		TEMPERATURE : 40±2°C HUMIDITY : 90 ~ 95% APPLIED CURRENT : PER SPEC. TIME : 500 HOURS
HIGH TEMP. RESISTANCE TEST		TEMPERATURE : 85±2°C APPLIED CURRENT : PER SPEC. TIME : 500 HOURS



**RoHS Compliant**

NOTE : Specifications subject to change without notice. Please check our website for latest information.

05.05.2008



**SUPERWORLD ELECTRONICS (S) PTE LTD**

PG. 5