

Industrial Line – T100Q Series

100W 2:1 SINGLE OUTPUT DC/DC CONVERTER

Features

- Single output up to 30A
- Compact size
- High efficiency up to 90%
- 2:1 wide input voltage range
- Fixed switching frequency
- Industry standard footprint
- No minimum load
- Adjustable output voltage
- Under-voltage lockout
- RoHS compliant



Specifications

INPUT

Voltage range	24V nominal input	18-36VDC
	48V nominal input	36-75VDC
Input filter	L-C type.	
Input surge voltage	24V input	50VDC
	48V input	100VDC
Start up time	Power up	25mS typ
	Remote ON/OFF	25ms typ
Start-up voltage	Nominal Vin and constant resistive load.	
	24V input	17VDC
	48V input	34VDC
Shutdown voltage	24V input	15VDC
	48V input	32VDC

Remote ON/OFF⁶

Positive logic:	Negative logic (standard):	
	DC/DC ON:	Short or $0V < V_r < 1.2V$
	DC/DC OFF:	Open or $3V < V_r < 15V$
	Positive logic (option):	
	DC/DC ON:	Open or $3V < V_r < 15V$
	DC/DC OFF:	Short or $0V < V_r < 1.2V$
	Input current of remote control pin:	
	-0.5mA to +0.5mA, nominal Vin.	
	Remote off state input current:	
	2.5mA, nominal Vin.	

OUTPUT

Power	100W max.
Voltage accuracy	$\pm 1.5\%$, full load and nominal Vin.
Minimum load	0%.
Voltage adjustability ⁵	+10%, -20%.
Line regulation	$\pm 0.2\%$, LL to HL at full load.
Load regulation	See table, no load to full load.
Remote sense ⁵	10% of Vout.
Ripple and noise	See table, 20MHz bandwidth (measured with a $1\mu F$ M/C and a $10\mu F$ T/C).
Temperature coefficient	$\pm 0.02\%/^{\circ}C$ max.
Transient response	200 μS , recovery time 25% load step change.
Over voltage prot. threshold	120% Vout max (non-latching hiccup).
Short circuit protection	Hiccup, automatic recovery.

ENVIRONMENTAL

Operating baseplate temp. ⁷	-40°C to +100°C (with derating).
Over temp. protection	110°C typ.
Storage temperature	-55°C to +125°C.
Thermal shock	MIL-STD-810F.
Vibration	MIL-STD-810F.
Relative humidity	95% max non-condensing.

GENERAL

Efficiency	See table.
Isolation voltage	Input to output: 1600VDC min.
	Input to case: 1000VDC min.
	Output to case: 1000VDC min.
Isolation resistance	10 ⁷ ohms, min.
Isolation capacitance	2500pF, max.
Switching frequency	270KHz typ.
Case material.	Aluminum base plate.
Weight	42g.
MTBF ¹	Bellcore TR-NWT-000332: 2.500 x 10 ⁶ hrs. MIL-HDBK-217F: 6.311 x 10 ⁵ hrs

STANDARDS

Safety standards	IEC60950-1, UL60950-1, EN60950-1.
EMC	
EMI ⁸	EN55022 Class A..
Radiated immunity	EN61000-4-3 Criteria A, 10V/m.
Fast transient	EN61000-4-4 Criteria B, $\pm 2KV$.
Surge ⁹	EN61000-4-5 Criteria B, $\pm 1KV$.
Conducted immunity	EN61000-4-6 Criteria A, 10 Vr.m.s.

Industrial Line – T100Q Series

100W 2:1 SINGLE OUTPUT DC/DC CONVERTER

MODEL NUMBER	INPUT RANGE	OUTPUT VOLTAGE	OUTPUT CURRENT		OUTPUT ⁴ RIPPLE & NOISE	INPUT CURRENT		EFF ⁴	LOAD REGULATION
			MIN LOAD	FULL LOAD		NO LOAD ²	FULL LOAD ²		
PEB100-24S3P3	18 – 36 VDC	3.3 VDC	0 mA	25 A	100 mVp-p	80 mA	3997 mA	89%	10 mV
PEB100-24S05	18 – 36 VDC	5 VDC	0 mA	20 A	100 mVp-p	120 mA	4845 mA	90%	15 mV
PEB100-24S12	18 – 36 VDC	12 VDC	0 mA	8.33 A	100 mVp-p	130 mA	4843 mA	90%	36 mV
PEB100-24S15	18 – 36 VDC	15 VDC	0 mA	6.67 A	100 mVp-p	190 mA	4847 mA	90%	45 mV
PEB100-48S1P8	36 – 75 VDC	1.8 VDC	0 mA	30 A	100 mVp-p	70 mA	1389 mA	85%	5.4 mV
PEB100-48S2P5	36 – 75 VDC	2.5 VDC	0 mA	30 A	100 mVp-p	70 mA	1883 mA	87%	7.5 mV
PEB100-48S3P3	36 – 75 VDC	3.3 VDC	0 mA	25 A	100 mVp-p	75 mA	2022 mA	89%	10 mV
PEB100-48S05	36 – 75 VDC	5 VDC	0 mA	20 A	100 mVp-p	80 mA	2422 mA	90%	15 mV
PEB100-48S12	36 – 75 VDC	12 VDC	0 mA	8.33 A	100 mVp-p	130 mA	2422 mA	90%	36 mV
PEB100-48S15	36 – 75 VDC	15 VDC	0 mA	6.67 A	100 mVp-p	130 mA	2424 mA	90%	45 mV

Notes:

- BELLCORE TR-NWT-000332. Case 1: 80% Stress, Temperature at 40°C. MIL-HDBK-217F Notice2 @Ta=25 °C, Full load(Ground, Benign, controlled environment)
- Maximum value at nominal input voltage and full load of standard type.
- Typical value at nominal input voltage and no load.
- Typical value at nominal input voltage and full load.
- Maximum output deviation is 10% inclusive of trim. If remote sense is not being used, the + sense should be connected to its corresponding +OUTPUT and likewise the -sense should be connected to its corresponding -OUTPUT.
- The positive logic and pin length are optional (see table). The pin voltage is referenced to .Vin.
- Heat sink is optional and PIN F7G-0029A-F, 7G-0030A-F, 7G-0031A-F, 7G-0032A-F.
- The PEB100 meets EN55022 class A and class B only with external components connected before the input pin to the converter.
- An external input filter capacitor is required if the module has to meet EN61000-4-4, EN61000-4-5. The filter capacitor Powerbox suggest: Nippon chemi-con KY series, 220µF/100V, ESR 48mΩ.
- BASEPLATE GROUNDING FBase-plate should be grounded at one of the four screw bolts prior to operation.
- The converter is provided by basic insulation.

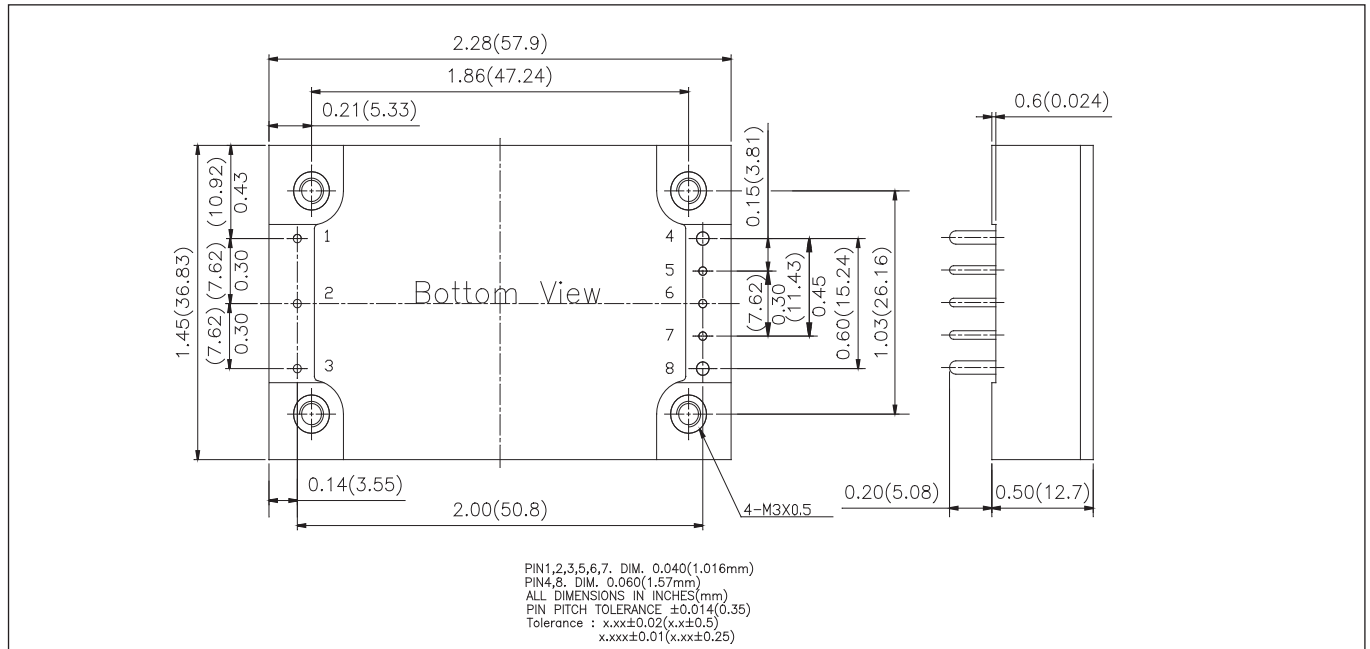

PIN	FUNCTION
1	- INPUT
2	ON/OFF
3	+ INPUT
4	- OUTPUT
5	- SENSE
6	TRIM
7	+ SENSE
8	+ OUTPUT

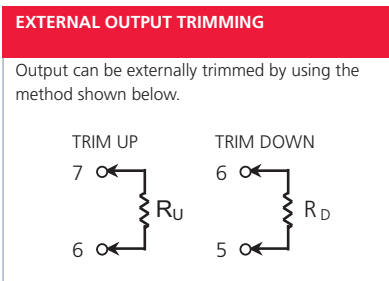

PRODUCT OPTIONS TABLE

OPTIONSUFFIX	
Negative remote ON/OFF logic, 0.20" pin length (standard)	-
Negative remote ON/OFF logic, 0.145" pin length	-L
Negative remote ON/OFF logic, 0.11" pin length	-K
Positive remote ON/OFF logic, 0.20" pin length	-P
Positive remote ON/OFF logic, 0.145" pin length	-S
Positive remote ON/OFF logic, 0.11" pin length	-M

Example: PEB100-48S3P3-P

Industrial Line – T100Q Series

100W 2:1 SINGLE OUTPUT DC/DC CONVERTER

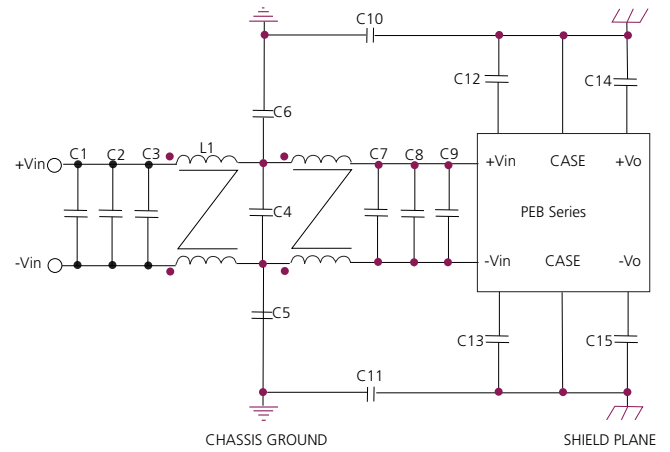
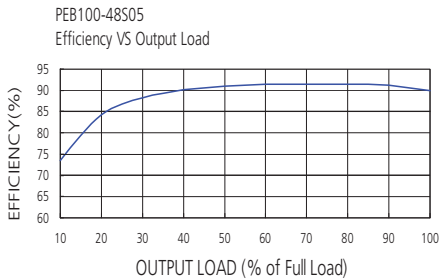
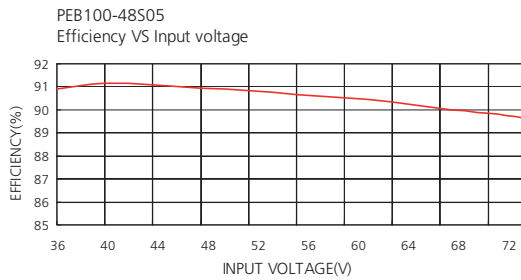
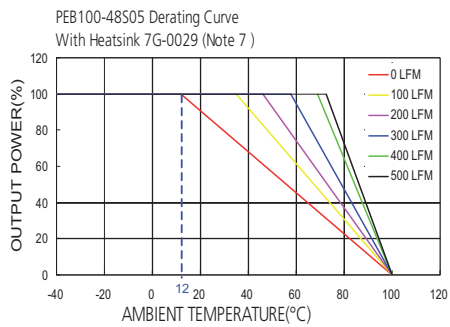
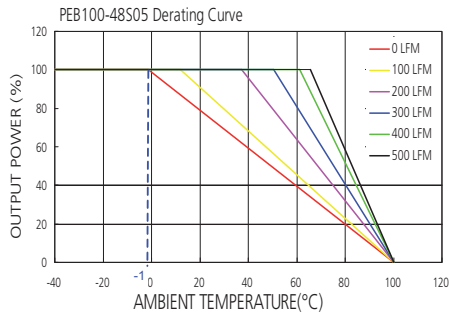

Recommended filter for EN55022 Class B compliance

The components used in the above figure, together with the manufacturer's part numbers for these components, are as follows:

PEB100-24Sxx	C1	C2	C3	C4	C5
	685pF/50V	685pF/50V	685pF/50V	685pF/50V	1.5nF/3KV
	C6	C7	C8	C9	C10
	1.5nF/3KV	685pF/50V	685pF/50V	685pF/50V	0.1µF/50V
	C11	C12	C13	C14	C15
0.1µF/50V	1.0nF/3KV	1.0nF/3KV	1.0nF/3KV	1.0nF/3KV	
	L1	L2			
	1.37mH	1.37mH			

PEB100-48Sxx	C1	C2	C3	C4	C5
	100µF/100V	1.5µF/100V	1.5µF/100V	1.5µF/100V	1.5µF/3KV
	C6	C7	C8	C9	C10
	1.5nF/3KV	47µF/100V	1.5µF/100V	1.5µF/100V	0.1µF/50V
	C11	C12	C13	C14	C15
0.1µF/50V	1.0nF/3KV	1.0nF/3KV	1.0nF/3KV	1.0nF/3KV	
	L1	L2			
	620µH	620µH			

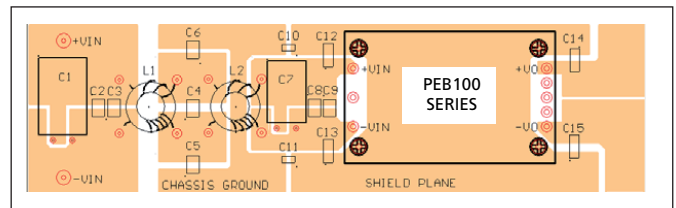

Recommended EN55022 Class B Filter Circuit Layout

Specifications are subject to change without notice.