

PRELIMINARY - August 11, 2000

TEL:805-498-2111 FAX:805-498-3804 WEB:http://www.semtech.com

DESCRIPTION

The SC1464 is a versatile charge pump designed for use in battery operated power supply applications. A simple, low current charge pump doubler can be implemented without costly inductors or capacitors. Internal MOSFET's and control circuitry eliminate the need for costly board space and design time. The small device footprint allows for compact circuit design.

The SC1464 charge pump can be used for applications that require up to 60mA of output current with $V_{IN} = 2.85V$ and $V_{OUT} = 5.2V$. The small 8 lead MSOP-8 package helps minimize board space.

The TF1 and TF2 pins provide binary control of the oscillator frequency to either 1 MHz, 260kHz, 32kHz or 8kHz. The user can change the frequency during operation with extremely fast settling time.

FEATURES

- Small size - MSOP-8 package
- Typical efficiency of 90% @ full load
- Designed to work with ceramic or tantalum capacitors
- Soft start functionality
- Short-Circuit and Over-Temperature protection
- $<55\mu A$ input current @ no load (TF1=0;TF2=1)
- $<330\mu A$ input current @ no load (TF1=0;TF2=0)
- Oscillator frequency accurate to $\pm 5\%$
- Shutdown current $< 1\mu A$
- All Specifications rated over the full temperature range ($-40^{\circ}C$ to $85^{\circ}C$)

APPLICATIONS

- Cellular phones
- Handheld devices
- PDA power supplies
- Peripheral card supplies

ORDERING INFORMATION

Part Number ⁽¹⁾	Package
SC1464CMS.TR	MSOP-8

Note:

(1) Only available in tape and reel packaging. A reel contains 2500 devices.

APPLICATION CIRCUIT

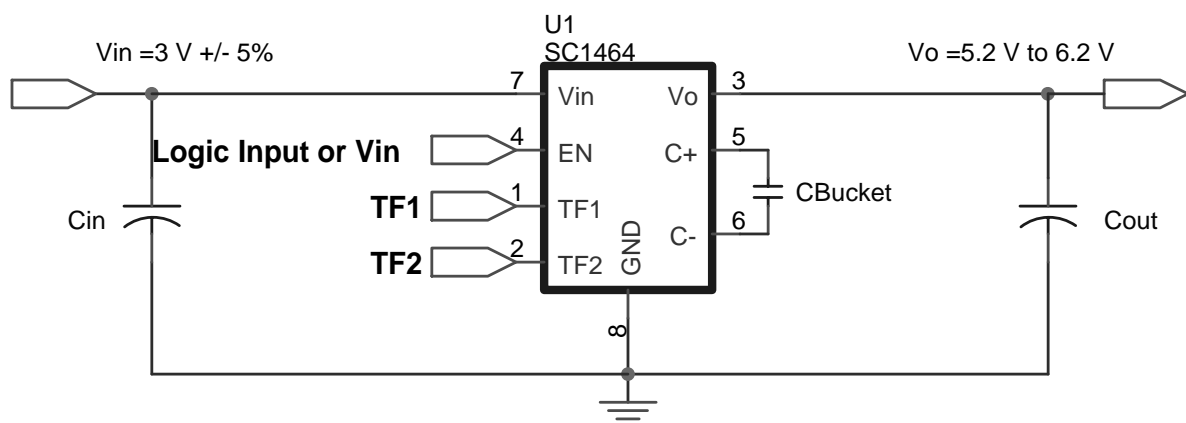

Iout	Freq	Cin	Cout	CBucket
60mA	260kHz	3.3uF	3.3uF	2.2uF
20mA	260kHz	1.0uF	1.0uF	0.22uF
60mA	1MHz	1.0uF	1.0uF	0.22uF
20mA	1MHz	0.22uF	0.22uF	0.10uF

PRELIMINARY - August 11, 2000

ABSOLUTE MAXIMUM RATINGS

Parameter	Symbol	Maximum	Units
Input Supply Voltage	V_{IN}	-0.3 to +4	V
Output Voltage	V_O	-0.3 to +8	V
V_{OUT} Short-Circuit Duration	SC	Indefinite	
Operating Ambient Temperature Range	T_A	-40 to +85	°C
Operating Junction Temperature	T_J	-40 to +125	°C
Storage Temperature Range	T_{STG}	-65 to +150	°C
Lead Temperature (Soldering) 10 Sec	T_{LEAD}	300	°C
Thermal Temperature Junction to Ambient	θ_{JA}	185	°C/W
Thermal Impedance Junction to Case	θ_{JC}	47	°C/W

ELECTRICAL CHARACTERISTICS

 Unless specified, $T_A = -40^\circ\text{C}$ to 85°C , $EN = V_{IN}$, $C_{Bucket} = 2.2\mu\text{F}$ (ESR = 0.1Ω), C_{IN} , $C_{OUT} = 3.3\mu\text{F}$ (ESR = 1Ω), $V_{IN} = 3V \pm 5\%$, $V_{OUT} = 5.2V$ to $6.2V$.

Parameter	Symbol	Test Conditions	MIN	TYP	MAX	Units
Input Supply Voltage	V_{IN}		2.5		3.5	V
Input Supply Current	I_{IN}	$I_O = 0$ TF1 = 0, TF2 = 1, freq = 8kHz		45	55	μA
		$I_O = 0$ TF1 = 0, TF2 = 0, freq = 32kHz		270	330	
		$I_O = 0$ TF1 = 1, TF2 = 0, freq = 260kHz		1.6	2	mA
		$I_O = 0$ TF1 = 1, TF2 = 1, freq = 1MHz		5.8	8	
		EN = GND			1	μA
Output Current	I_O	$V_I = 2.85$, TF1 = 0, TF2 = 1. freq = 8kHz	5			mA
		$V_I = 2.85$, TF1 = 0, TF2 = 0. freq = 32kHz	20			
		$V_I = 2.85$, TF1 = 1, TF2 = 0. freq = 260kHz	60			
		$V_I = 2.85$, TF1 = TF2 = 1. freq = 1MHz $C_{bucket} = 220\text{nF}$	45			
Max. Output Voltage ⁽³⁾	V_{OUT}	$I_O = 0$			$2 \cdot V_{IN}$	V
Short Circuit Current	I_{SC}	$V_O = 0$ to $V_{IN} - 1V$, $I_O = I_{IN}$			170	mA
Output Ripple (pk-pk) ⁽¹⁾⁽³⁾	V_R	$I_O = 60\text{mA}$, Frequency = 260kHz		150		mV
Power Efficiency	η	$I_O = 60\text{mA}$, TF1 = 1, TF2 = 0	85			%
Oscillator Frequency	OSC	TF1 = 0, TF2 = 1	7.82	8.50	9.18	kHz
		TF1 = 0, TF2 = 0	30.18	32.80	35.42	kHz
		TF1 = 1, TF2 = 0	241.13	262.10	283.07	kHz
		TF1 = TF2 = 1	0.92	1.00	1.08	MHz

PRELIMINARY - August 11, 2000

ELECTRICAL CHARACTERISTICS

 Unless specified, $T_A = -40^\circ\text{C}$ to 85°C , $E_N = V_{IN}$, $C_{\text{Bucket}} = 2.2\mu\text{F}$ (ESR = 0.1Ω), C_{IN} , $C_{OUT} = 3.3\mu\text{F}$ (ESR = 1Ω), $V_{IN} = 3V \pm 5\%$, $V_{OUT} = 5.2V$ to $6.2V$.

Parameter	Symbol	Test Conditions	MIN	TYP	MAX	Units
Time to Regulation at Turn-on ⁽²⁾⁽³⁾	t_{ON}	$I_O = 0$ to 60 mA freq = 260kHz		420	1000	μs
Input High Threshold	V_{ih}	All input pins	1.3			V
Input Low Threshold	V_{il}	All input pins			0.4	V
Inrush Current ⁽³⁾	I_{INRUSH}	Upon application of V_{IN} , Maximum average current over 10 periods			750	mA
Over Temperature protection ⁽³⁾	O.T.			170		$^\circ\text{C}$
Over Temperature Hysteresis ⁽³⁾	O.T.H			10		$^\circ\text{C}$

NOTES:

(1) All electrical characteristics are for the application circuit on page 2.

 (2) Soft start functionality is performed along with short circuit protection. If V_{OUT} is less than $V_{IN} - 200\text{mV}$, then all switches are turned off and V_{OUT} is charged with a 70mA current source from V_{IN} . When V_{OUT} reaches $V_{IN} - 200\text{mV}$, then a current limit version of the switches are turned on until V_{OUT} reaches $V_{IN} +$ a PMOS threshold, at which point all switches are enabled.

(3) Guaranteed by design.

PRELIMINARY - August 11, 2000

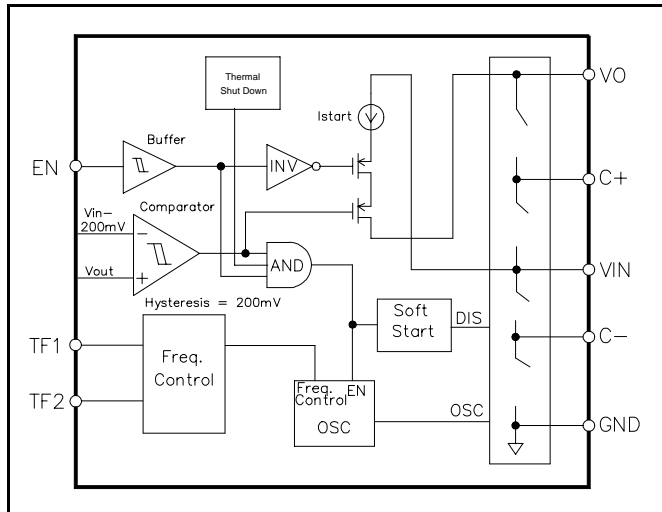
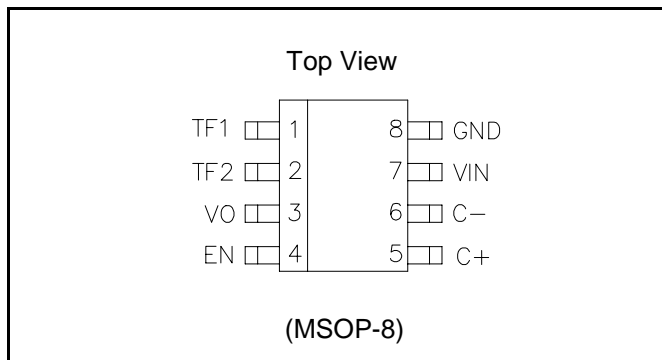
BLOCK DIAGRAM

PIN CONFIGURATION

PIN DESCRIPTION

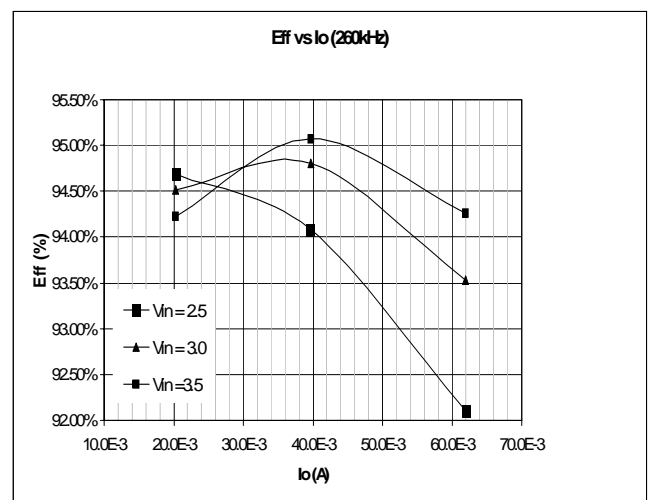
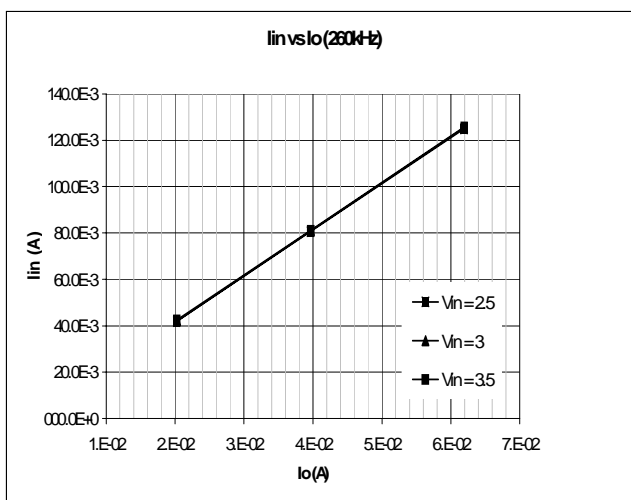
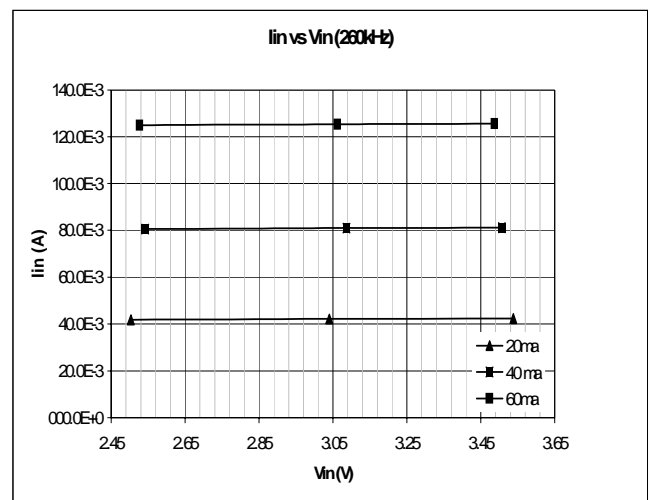
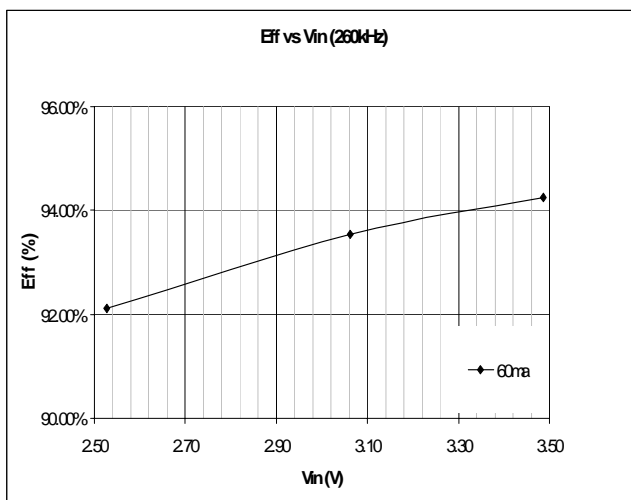
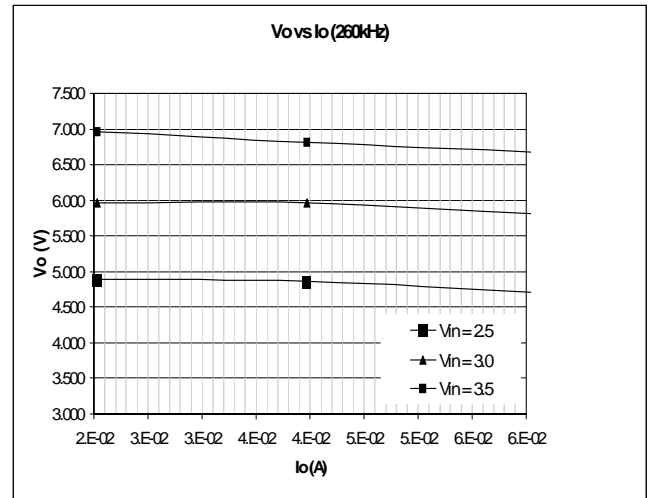
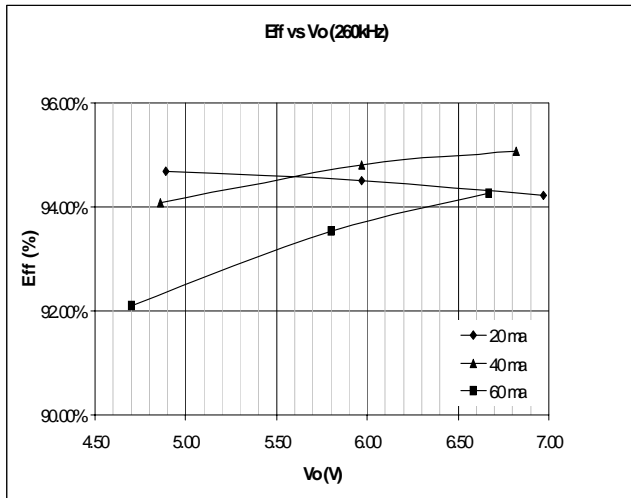
Pin#	Pin Name	Pin Function															
1	TF1	Binary frequency select pins. The frequency is set according to the following table.															
2	TF2																
		<table border="1" style="margin-left: auto; margin-right: auto; border-collapse: collapse;"> <tr> <td colspan="2"></td> <td colspan="2" style="text-align: center;">TF1</td> </tr> <tr> <td colspan="2"></td> <td style="text-align: center;">0</td> <td style="text-align: center;">1</td> </tr> <tr> <td rowspan="2" style="text-align: center;">TF2</td> <td style="text-align: center;">0</td> <td style="text-align: center;">32kHz</td> <td style="text-align: center;">260kHz</td> </tr> <tr> <td style="text-align: center;">1</td> <td style="text-align: center;">8kHz</td> <td style="text-align: center;">1MHz</td> </tr> </table>			TF1				0	1	TF2	0	32kHz	260kHz	1	8kHz	1MHz
		TF1															
		0	1														
TF2	0	32kHz	260kHz														
	1	8kHz	1MHz														
3	VO	Voltage output															
4	EN	Enable. Pull EN low to reduce the current on VIN to less than 1μA.															
5	C+	This pin should be connected to the positive terminal of the external charging capacitor.															
6	C-	This pin should be connected to the negative terminal of the external charging capacitor.															
7	VIN	Supply voltage input.															
8	GND	Ground.															

PRELIMINARY - August 11, 2000

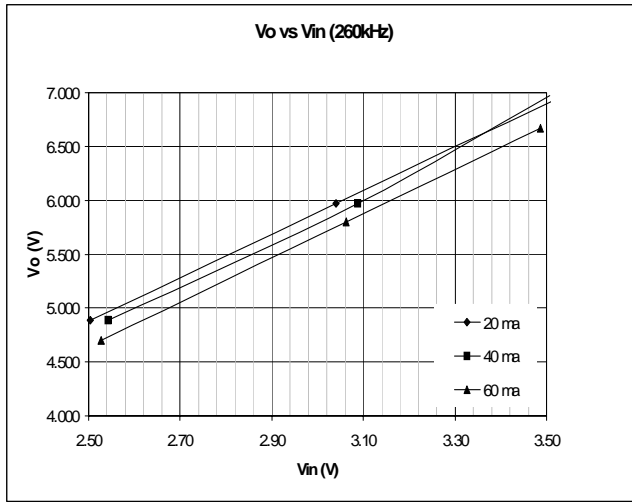

PRELIMINARY - August 11, 2000



PRELIMINARY - August 11, 2000

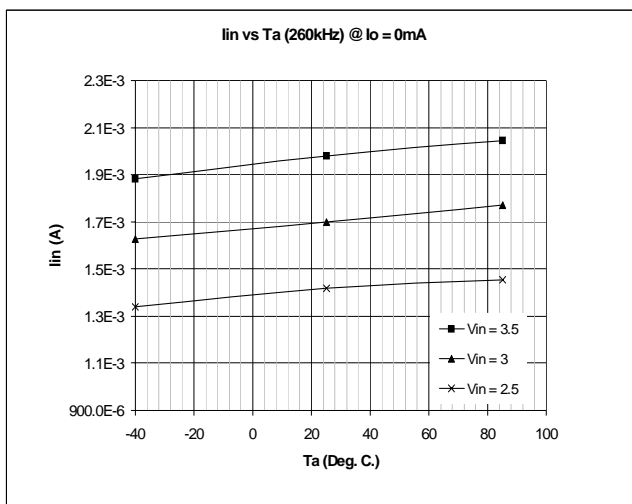
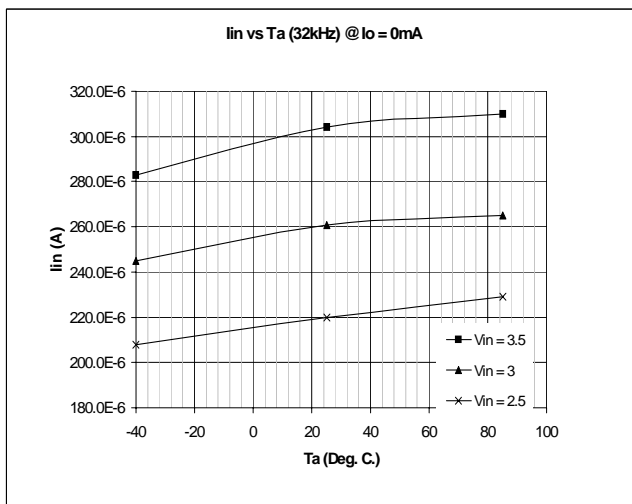
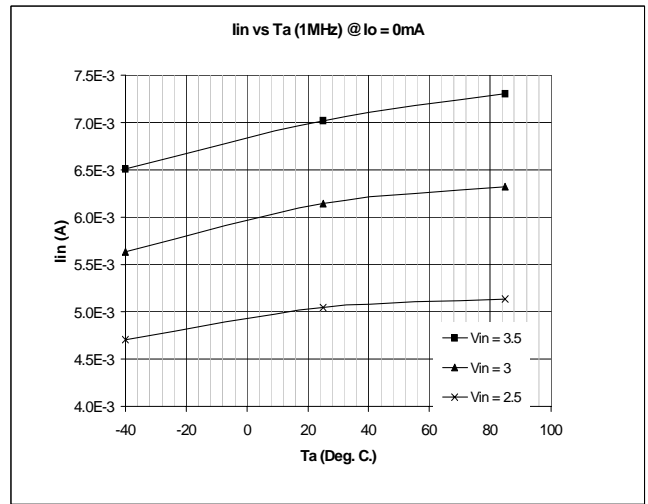
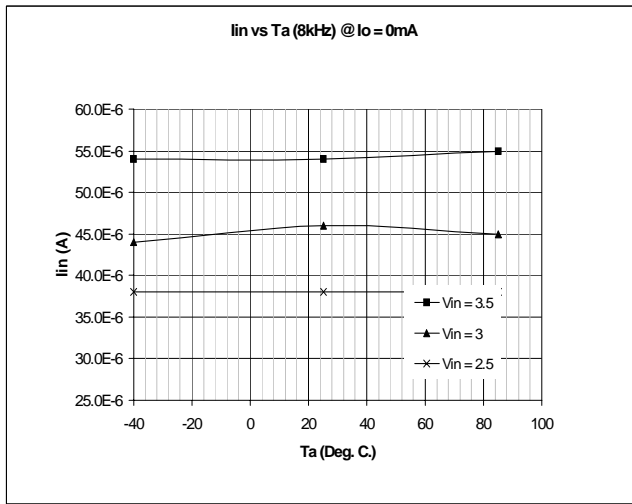

PRELIMINARY - August 11, 2000

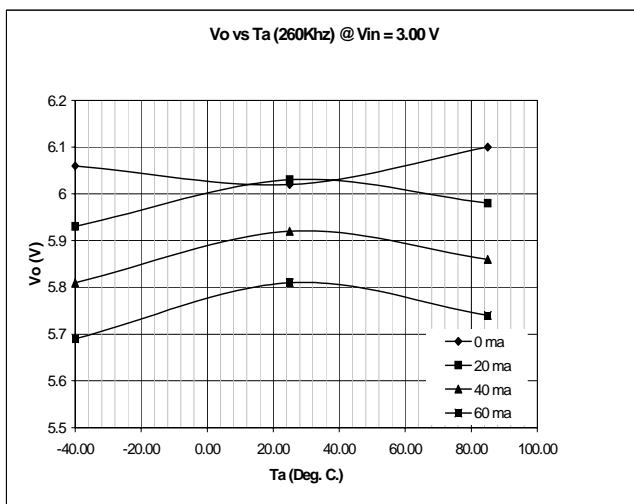
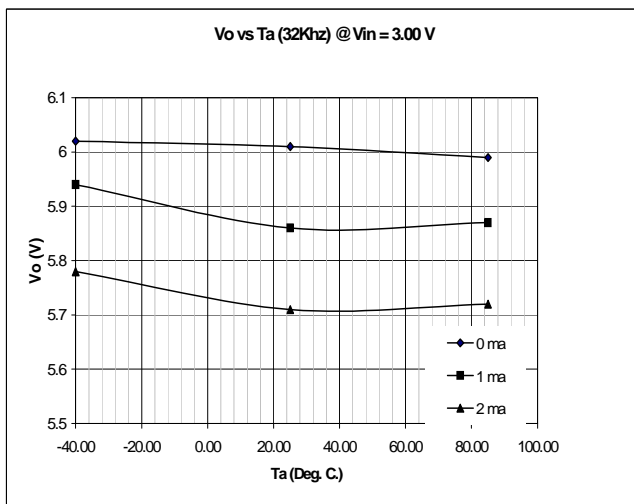
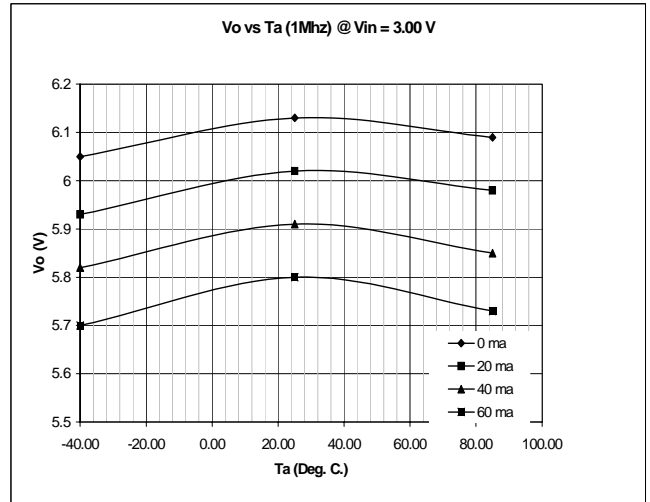
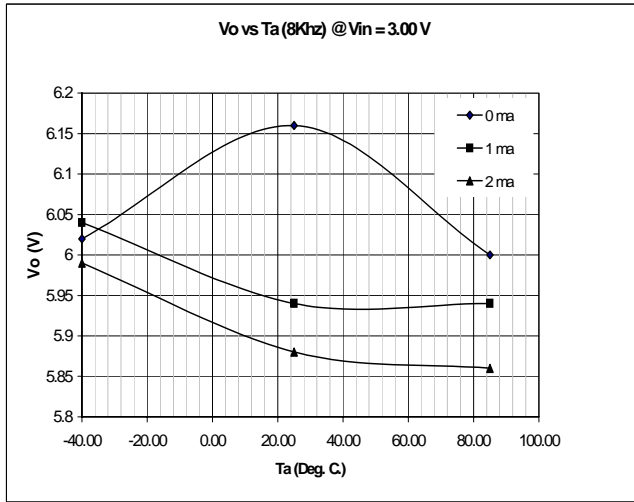

PRELIMINARY - August 11, 2000

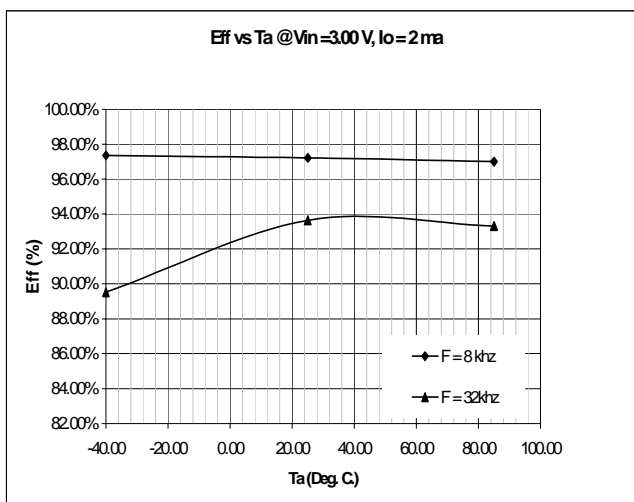
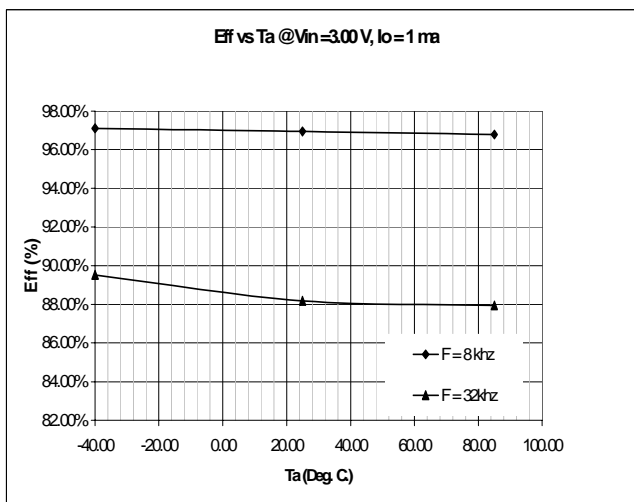
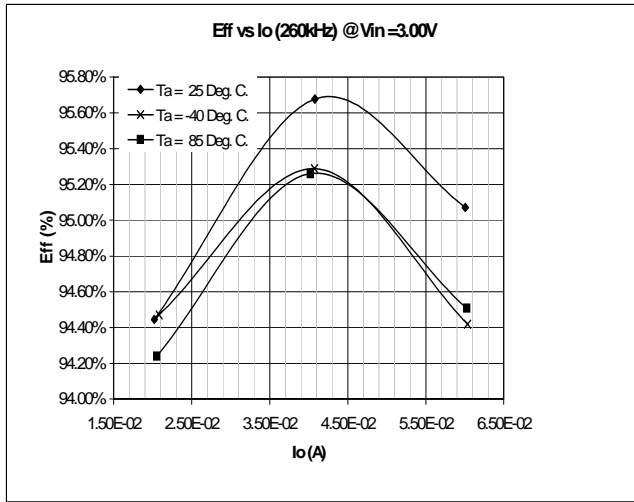

PRELIMINARY - August 11, 2000

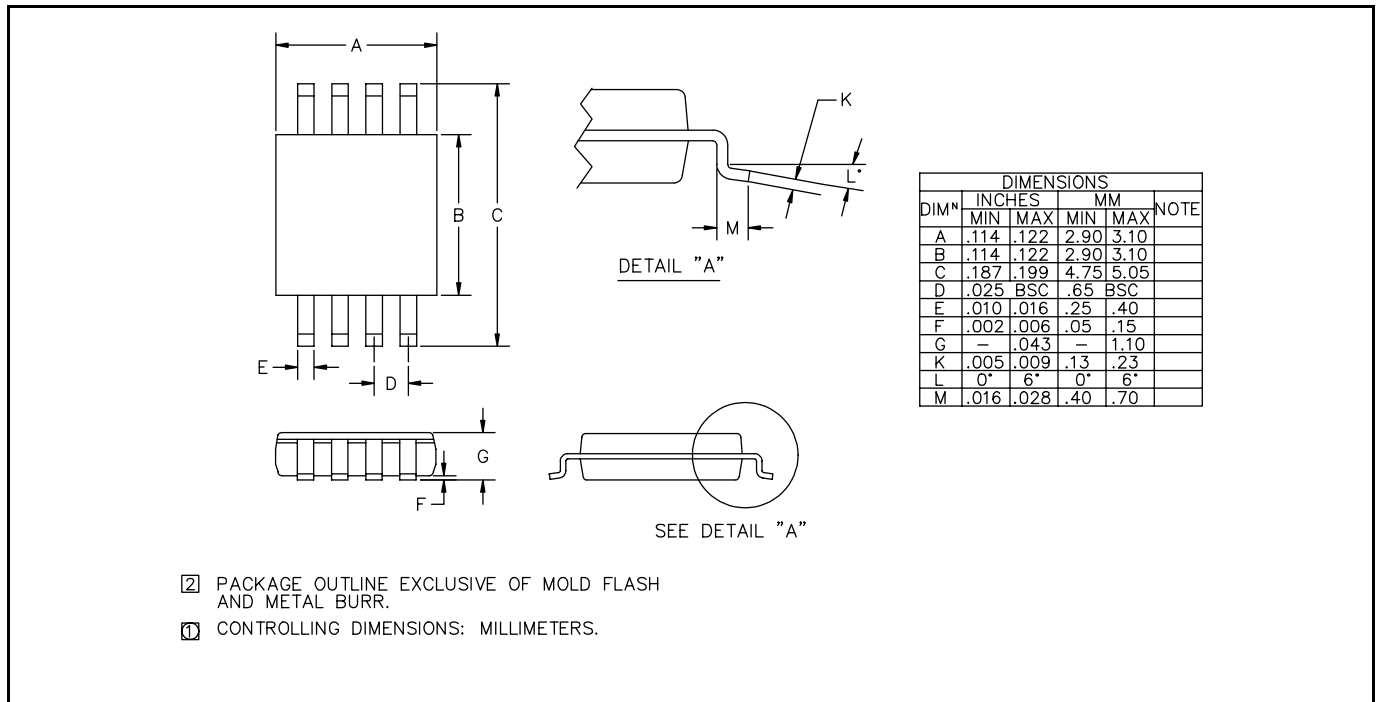
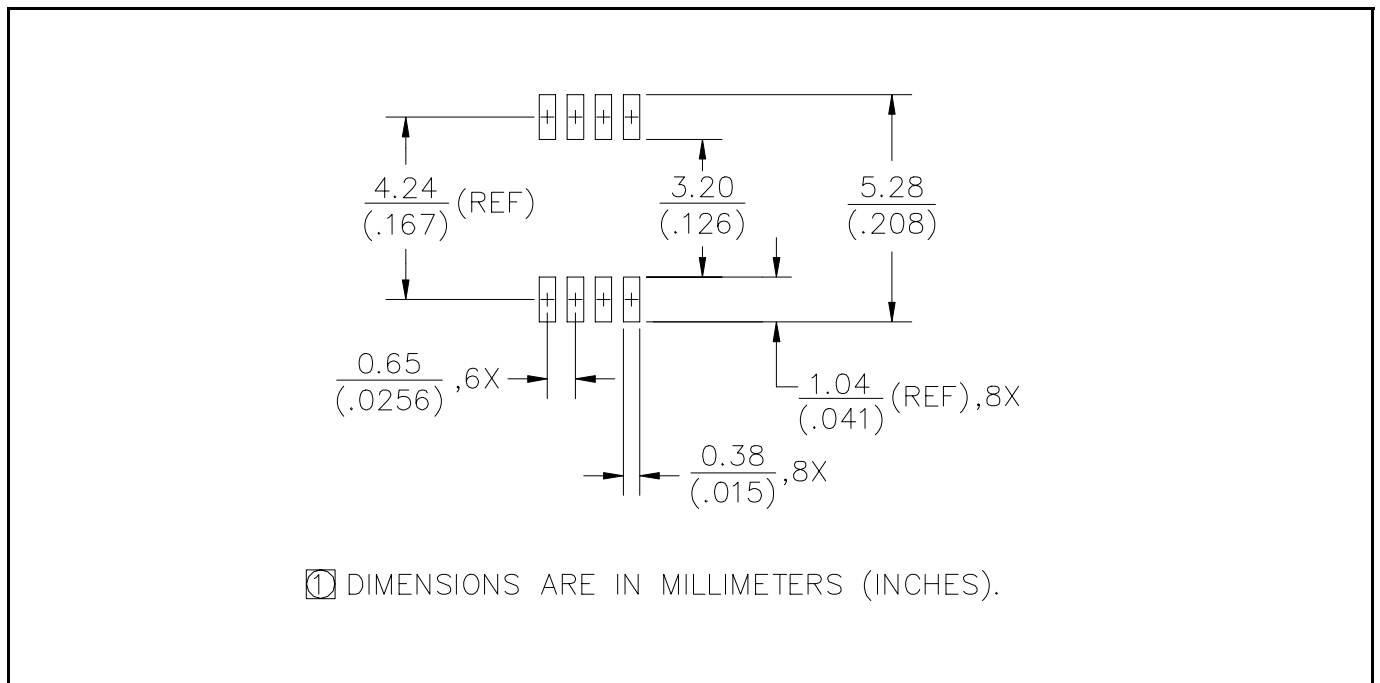
OUTLINE DRAWING - MSOP-8

LAND PATTERN - MSOP-8

ECN 00-1246