

Features

- 12MHz -3dB bandwidth
- Supply voltage = 4.5V to 16.5V
- Low supply current (per amplifier) = 500µA
- High slew rate = 10V/µs
- Unity-gain stable
- Beyond the rails input capability
- Rail-to-rail output swing
- Ultra-small package

Applications

- TFT-LCD drive circuits
- Electronics notebooks
- Electronics games
- Touch-screen displays
- Personal communication devices
- Personal digital assistants (PDA)
- Portable instrumentation
- Sampling ADC amplifiers
- Wireless LANs
- Office automation
- Active filters
- ADC/DAC buffer

Ordering Information

Part No.	Package	Tape & Reel	Outline #
EL5220CY	8-Pin MSOP	-	MDP0043
EL5220CY-T7	8-Pin MSOP	7"	MDP0043
EL5220CY-T13	8-Pin MSOP	13"	MDP0043
EL5420CL	16-Pin LPP	-	MDP0046
EL5420CL-T7	16-Pin LPP	7"	MDP0046
EL5420CL-T13	16-Pin LPP	13"	MDP0046
EL5420CR	14-Pin TSSOP	-	MDP0044
EL5420CR-T7	14-Pin TSSOP	7"	MDP0044
EL5420CR-T13	14-Pin TSSOP	13"	MDP0044
EL5420CS	14-Pin SO	-	MDP0027
EL5420CS-T7	14-Pin SO	7"	MDP0027
EL5420CS-T13	14-Pin SO	13"	MDP0027

General Description

The EL5420C and EL5220C are low power, high voltage, rail-to-rail input-output amplifiers. The EL5220C contains two amplifiers in one package, and the EL5420C contains four amplifiers. Operating on supplies ranging from 5V to 15V, while consuming only 500µA per amplifier, the EL5420C and EL5220C have a bandwidth of 12MHz (-3dB). They also provide common mode input ability beyond the supply rails, as well as rail-to-rail output capability. This enables these amplifiers to offer maximum dynamic range at any supply voltage.

The EL5420C and EL5220C also feature fast slewing and settling times, as well as a high output drive capability of 30mA (sink and source). These features make these amplifiers ideal for use as voltage reference buffers in Thin Film Transistor Liquid Crystal Displays (TFT-LCD). Other applications include battery power, portable devices, and anywhere low power consumption is important.

The EL5420C is available in a space-saving 14-pin TSSOP package, the industry-standard 14-pin SO package, as well as a 16-pin LPP package. The EL5220C is available in the 8-pin MSOP package. Both feature a standard operational amplifier pin out. These amplifiers are specified for operation over the full -40°C to +85°C temperature range.

Connection Diagrams

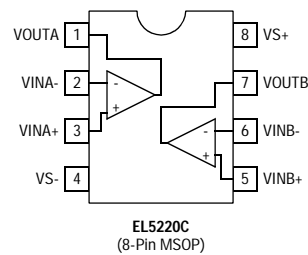
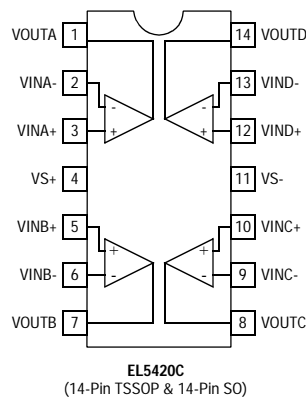

Connection Diagrams are continued on page 4

Note: All information contained in this data sheet has been carefully checked and is believed to be accurate as of the date of publication; however, this data sheet cannot be a "controlled document". Current revisions, if any, to these specifications are maintained at the factory and are available upon your request. We recommend checking the revision level before finalization of your design documentation.

EL5220C, EL5420C

12MHz Rail-to-Rail Input-Output Op Amps

Absolute Maximum Ratings (T_A = 25°C)

Values beyond absolute maximum ratings can cause the device to be prematurely damaged. Absolute maximum ratings are stress ratings only and functional device operation is not implied

Supply Voltage between V _{S+} and V _{S-}	+18V
Input Voltage	V _{S-} - 0.5V, V _S + 0.5V
Maximum Continuous Output Current	30mA

Maximum Die Temperature	+125°C
Storage Temperature	-65°C to +150°C
Operating Temperature	-40°C to +85°C
Power Dissipation	See Curves
ESD Voltage	2kV

Important Note:

All parameters having Min/Max specifications are guaranteed. Typ values are for information purposes only. Unless otherwise noted, all tests are at the specified temperature and are pulsed tests, therefore: T_J = T_C = T_A

Electrical Characteristics

V_{S+} = +5V, V_{S-} = -5V, R_L = 10kΩ and C_L = 10pF to 0V, T_A = 25°C unless otherwise specified.

Parameter	Description	Condition	Min	Typ	Max	Unit
Input Characteristics						
V _{OS}	Input Offset Voltage	V _{CM} = 0V		2	12	mV
TCV _{OS}	Average Offset Voltage Drift	[1]		5		μV/°C
I _B	Input Bias Current	V _{CM} = 0V		2	50	nA
R _{IN}	Input Impedance			1		GΩ
C _{IN}	Input Capacitance			1.35		pF
CMIR	Common-Mode Input Range		-5.5		+5.5	V
CMRR	Common-Mode Rejection Ratio	for V _{IN} from -5.5V to +5.5V	50	70		dB
A _{VOL}	Open-Loop Gain	-4.5V ≤ V _{OUT} ≤ +4.5V	75	95		dB
Output Characteristics						
V _{OL}	Output Swing Low	I _L = -5mA		-4.92	-4.85	V
V _{OH}	Output Swing High	I _L = 5mA	4.85	4.92		V
I _{SC}	Short Circuit Current			±120		mA
I _{OUT}	Output Current			±30		mA
Power Supply Performance						
PSRR	Power Supply Rejection Ratio	V _S is moved from ±2.25V to ±7.75V	60	80		dB
I _S	Supply Current (Per Amplifier)	No load		500	750	μA
Dynamic Performance						
SR	Slew Rate [2]	-4.0V ≤ V _{OUT} ≤ +4.0V, 20% to 80%		10		V/μs
t _s	Settling to +0.1% (A _V = +1)	(A _V = +1), V _O = 2V step		500		ns
BW	-3dB Bandwidth	R _L = 10kΩ, C _L = 10pF		12		MHz
GBWP	Gain-Bandwidth Product	R _L = 10kΩ, C _L = 10pF		8		MHz
PM	Phase Margin	R _L = 10kΩ, C _L = 10 pF		50		°
CS	Channel Separation	f = 5MHz		75		dB

1. Measured over operating temperature range
2. Slew rate is measured on rising and falling edges

EL5220C, EL5420C

12MHz Rail-to-Rail Input-Output Op Amps

EL5220C, EL5420C

Electrical Characteristics

$V_{S+} = 5V$, $V_{S-} = 0V$, $R_L = 10k\Omega$ and $C_L = 10pF$ to 2.5V, $T_A = 25^\circ C$ unless otherwise specified.

Parameter	Description	Condition	Min	Typ	Max	Unit
Input Characteristics						
V_{OS}	Input Offset Voltage	$V_{CM} = 2.5V$		2	10	mV
TCV_{OS}	Average Offset Voltage Drift	[1]		5		$\mu V/^\circ C$
I_B	Input Bias Current	$V_{CM} = 2.5V$		2	50	nA
R_{IN}	Input Impedance			1		$G\Omega$
C_{IN}	Input Capacitance			1.35		pF
CMIR	Common-Mode Input Range		-0.5		+5.5	V
CMRR	Common-Mode Rejection Ratio	for V_{IN} from -0.5V to +5.5V	45	66		dB
A_{VOL}	Open-Loop Gain	$0.5V \leq V_{OUT} \leq 4.5V$	75	95		dB
Output Characteristics						
V_{OL}	Output Swing Low	$I_L = -5mA$		80	150	mV
V_{OH}	Output Swing High	$I_L = +5mA$	4.85	4.92		V
I_{SC}	Short Circuit Current			± 120		mA
I_{OUT}	Output Current			± 30		mA
Power Supply Performance						
PSRR	Power Supply Rejection Ratio	V_S is moved from 4.5V to 15.5V	60	80		dB
I_S	Supply Current (Per Amplifier)	No load		500	750	μA
Dynamic Performance						
SR	Slew Rate [2]	$1V \leq V_{OUT} \leq 4V$, 20% to 80%		10		$V/\mu s$
t_S	Settling to +0.1% ($A_V = +1$)	($A_V = +1$), $V_O = 2V$ step		500		ns
BW	-3dB Bandwidth	$R_L = 10k\Omega$, $C_L = 10pF$		12		MHz
GBWP	Gain-Bandwidth Product	$R_L = 10k\Omega$, $C_L = 10pF$		8		MHz
PM	Phase Margin	$R_L = 10k\Omega$, $C_L = 10pF$		50		$^\circ$
CS	Channel Separation	$f = 5MHz$		75		dB

1. Measured over operating temperature range
2. Slew rate is measured on rising and falling edges

Electrical Characteristics

$V_{S+} = 15V$, $V_{S-} = 0V$, $R_L = 10k\Omega$ and $C_L = 10pF$ to 7.5V, $T_A = 25^\circ C$ unless otherwise specified.

Parameter	Description	Condition	Min	Typ	Max	Unit
Input Characteristics						
V_{OS}	Input Offset Voltage	$V_{CM} = 7.5V$		2	14	mV
TCV_{OS}	Average Offset Voltage Drift	[1]		5		$\mu V/^\circ C$
I_B	Input Bias Current	$V_{CM} = 7.5V$		2	50	nA
R_{IN}	Input Impedance			1		$G\Omega$
C_{IN}	Input Capacitance			1.35		pF
CMIR	Common-Mode Input Range		-0.5		+15.5	V
CMRR	Common-Mode Rejection Ratio	for V_{IN} from -0.5V to +15.5V	53	72		dB
A_{VOL}	Open-Loop Gain	$0.5V \leq V_{OUT} \leq 14.5V$	75	95		dB
Output Characteristics						
V_{OL}	Output Swing Low	$I_L = -5mA$		80	150	mV
V_{OH}	Output Swing High	$I_L = +5mA$	14.85	14.92		V

EL5220C, EL5420C

12MHz Rail-to-Rail Input-Output Op Amps

Electrical Characteristics (Continued)

$V_{S+} = 15V$, $V_{S-} = 0V$, $R_L = 10k\Omega$ and $C_L = 10pF$ to 7.5V, $T_A = 25^\circ C$ unless otherwise specified.

Parameter	Description	Condition	Min	Typ	Max	Unit
I _{SC}	Short Circuit Current			±120		mA
I _{OUT}	Output Current			±30		mA
Power Supply Performance						
PSRR	Power Supply Rejection Ratio	V _S is moved from 4.5V to 15.5V	60	80		dB
I _S	Supply Current (Per Amplifier)	No load		500	750	µA
Dynamic Performance						
SR	Slew Rate ^[2]	1V ≤ V _{OUT} ≤ 14V, 20% to 80%		10		V/µs
t _S	Settling to +0.1% (A _V = +1)	(A _V = +1), V _O = 2V step		500		ns
BW	-3dB Bandwidth	R _L = 10kΩ, C _L = 10pF		12		MHz
GBWP	Gain-Bandwidth Product	R _L = 10kΩ, C _L = 10pF		8		MHz
PM	Phase Margin	R _L = 10kΩ, C _L = 10 pF		50		°
CS	Channel Separation	f = 5MHz		75		dB

1. Measured over operating temperature range
2. Slew rate is measured on rising and falling edges

Connection Diagrams (Continued)

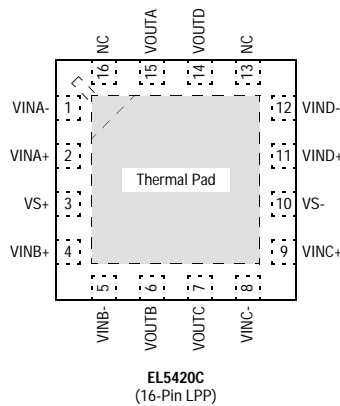

EL5220C, EL5420C

12MHz Rail-to-Rail Input-Output Op Amps

EL5220C, EL5420C

Typical Performance Curves

EL5420C Input Offset Voltage Distribution

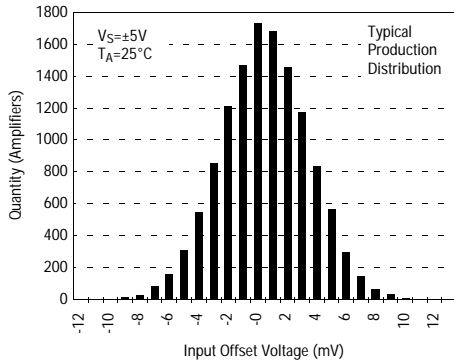

EL5420C Input Offset Voltage Drift

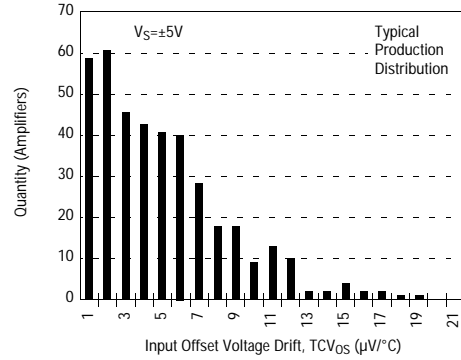

Input Offset Voltage vs Temperature

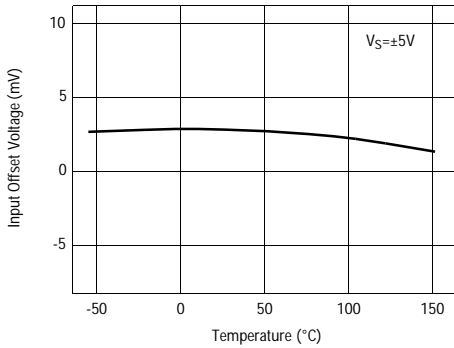

Input Bias Current vs Temperature

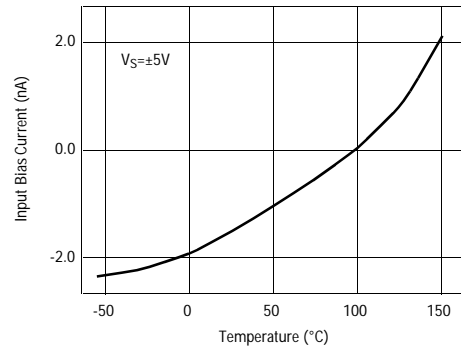

Output High Voltage vs Temperature

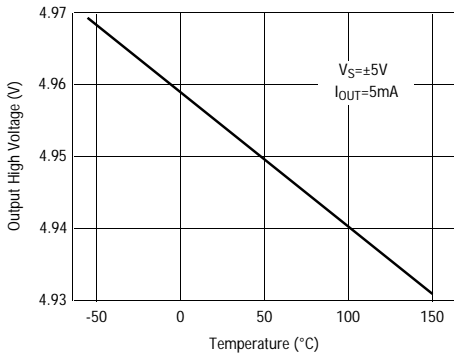

Output Low Voltage vs Temperature

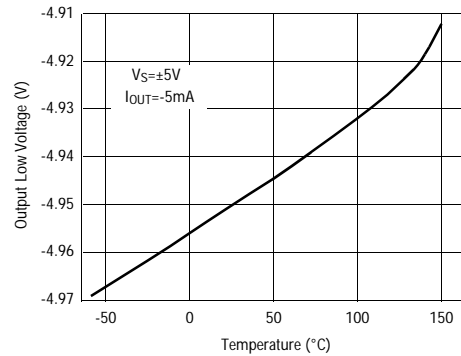

EL5220C, EL5420C

12MHz Rail-to-Rail Input-Output Op Amps

Typical Performance Curves

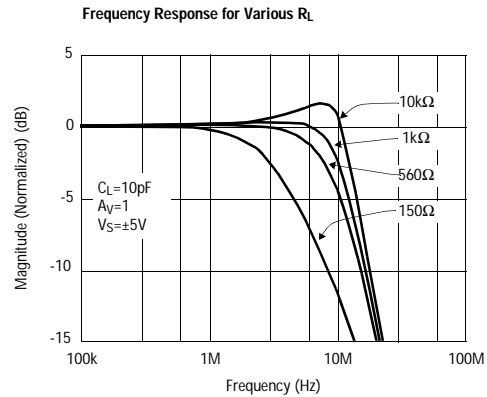
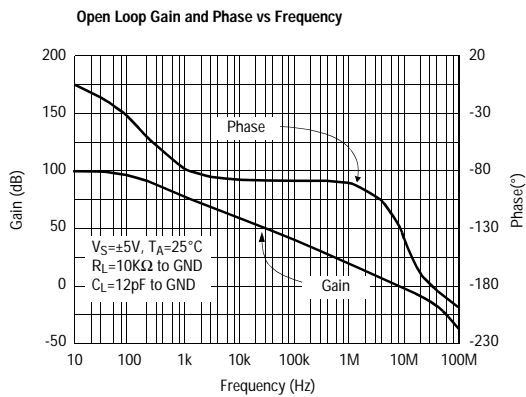
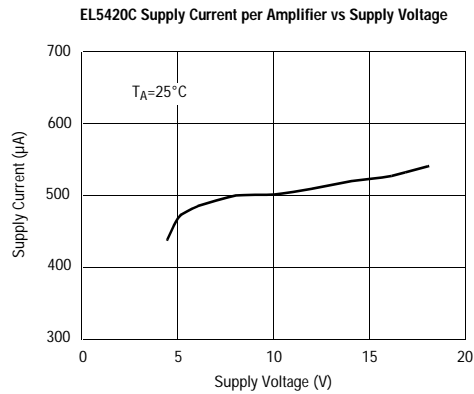
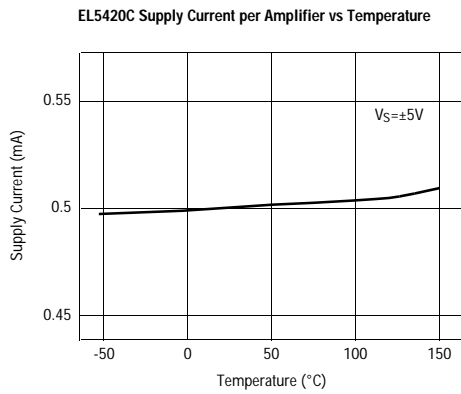
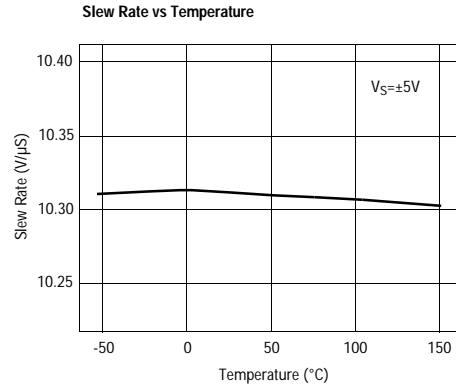
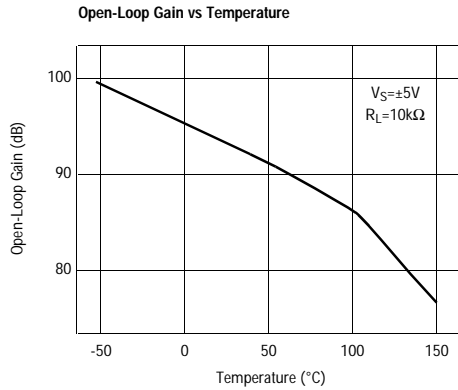

EL5220C, EL5420C

12MHz Rail-to-Rail Input-Output Op Amps

EL5220C, EL5420C

Typical Performance Curves

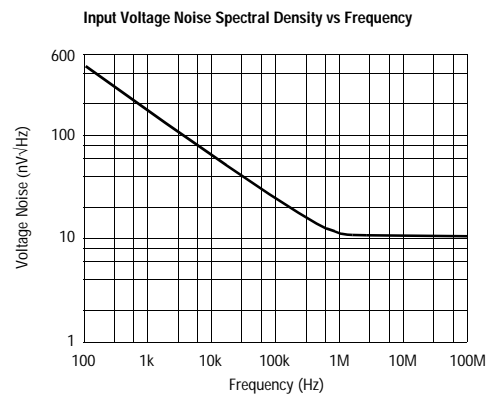
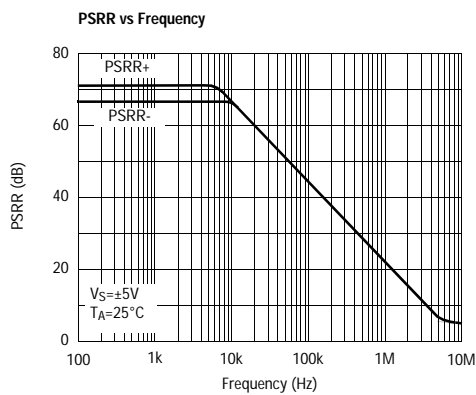
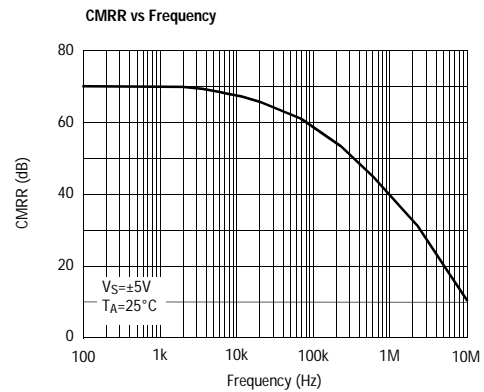
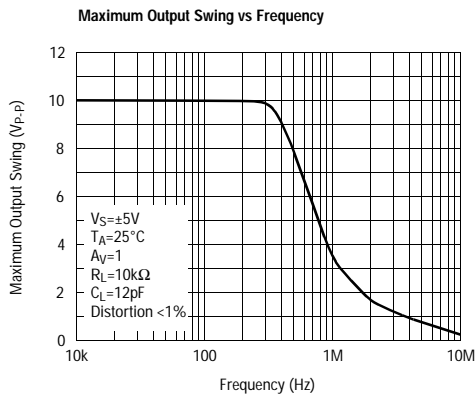
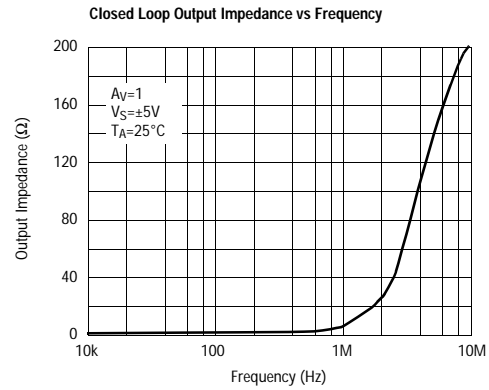
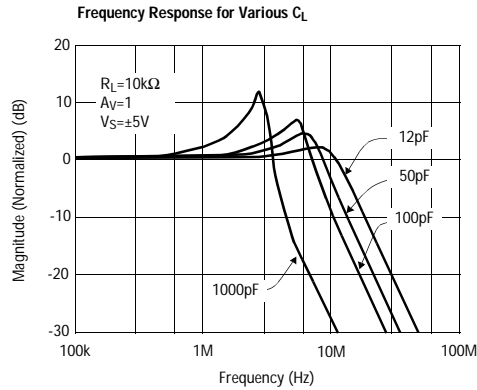

EL5220C, EL5420C

12MHz Rail-to-Rail Input-Output Op Amps

Typical Performance Curves

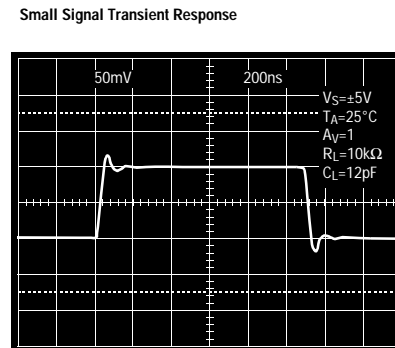
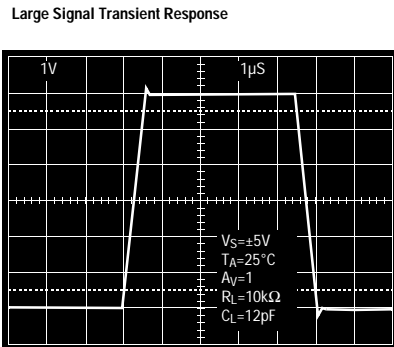
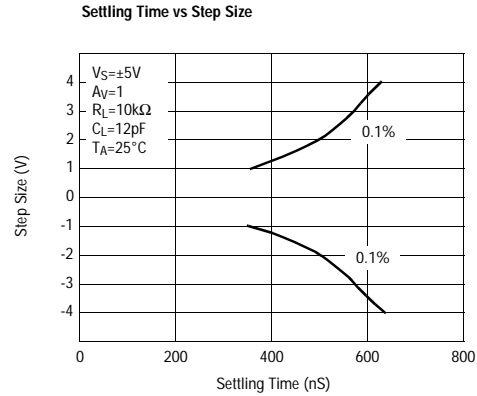
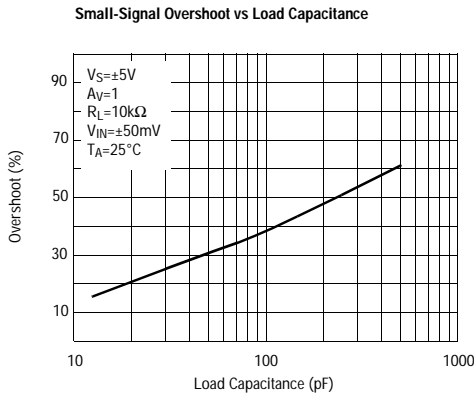
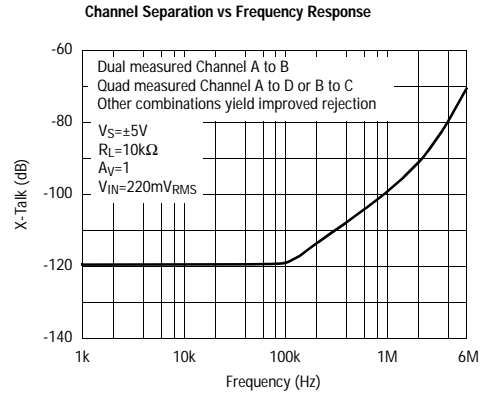
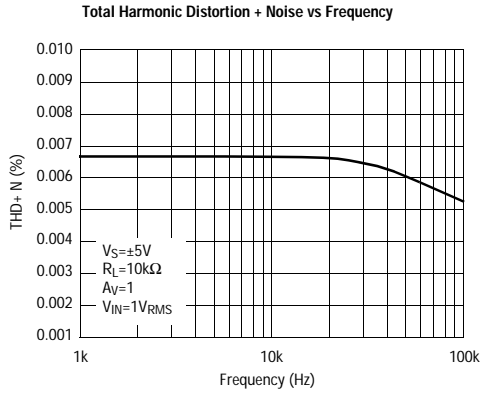

EL5220C, EL5420C

12MHz Rail-to-Rail Input-Output Op Amps

EL5220C, EL5420C

Pin Descriptions

EL5420C	EL5220C	Pin Name	Pin Function	Equivalent Circuit
1	1	VOUTA	Amplifier A Output	<p style="text-align: center;">Circuit 1</p>
2	2	VINA-	Amplifier A Inverting Input	<p style="text-align: center;">Circuit 2</p>
3	3	VINA+	Amplifier A Non-Inverting Input	(Reference Circuit 2)
4	8	VS+	Positive Power Supply	
5	5	VINB+	Amplifier B Non-Inverting Input	(Reference Circuit 2)
6	6	VINB-	Amplifier B Inverting Input	(Reference Circuit 2)
7	7	VOUTB	Amplifier B Output	(Reference Circuit 1)
8		VOUTC	Amplifier C Output	(Reference Circuit 1)
9		VINC-	Amplifier C Inverting Input	(Reference Circuit 2)
10		VINC+	Amplifier C Non-Inverting Input	(Reference Circuit 2)
11	4	VS-	Negative Power Supply	
12		VIND+	Amplifier D Non-Inverting Input	(Reference Circuit 2)
13		VIND-	Amplifier D Inverting Input	(Reference Circuit 2)
14		VOUTD	Amplifier D Output	(Reference Circuit 1)

EL5220C, EL5420C

12MHz Rail-to-Rail Input-Output Op Amps

Applications Information

Product Description

The EL5220C and EL5420C voltage feedback amplifiers are fabricated using a high voltage CMOS process. They exhibit rail-to-rail input and output capability, they are unity gain stable, and have low power consumption (500 μ A per amplifier). These features make the EL5220C and EL5420C ideal for a wide range of general-purpose applications. Connected in voltage follower mode and driving a load of 10k Ω and 12pF, the EL5220C and EL5420C have a -3dB bandwidth of 12MHz while maintaining a 10V/ μ s slew rate. The EL5220C is a dual amplifier while the EL5420C is a quad amplifier.

Operating Voltage, Input, and Output

The EL5220C and EL5420C are specified with a single nominal supply voltage from 5V to 15V or a split supply with its total range from 5V to 15V. Correct operation is guaranteed for a supply range of 4.5V to 16.5V. Most EL5220C and EL5420C specifications are stable over both the full supply range and operating temperatures of -40 $^{\circ}$ C to +85 $^{\circ}$ C. Parameter variations with operating voltage and/or temperature are shown in the typical performance curves.

The input common-mode voltage range of the EL5220C and EL5420C extends 500mV beyond the supply rails. The output swings of the EL5220C and EL5420C typically extend to within 80mV of positive and negative supply rails with load currents of 5mA. Decreasing load currents will extend the output voltage range even closer to the supply rails. Figure 1 shows the input and output waveforms for the device in the unity-gain configuration. Operation is from \pm 5V supply with a 10k Ω load connected to GND. The input is a 10V_{p-p} sinusoid. The output voltage is approximately 9.985V_{p-p}.

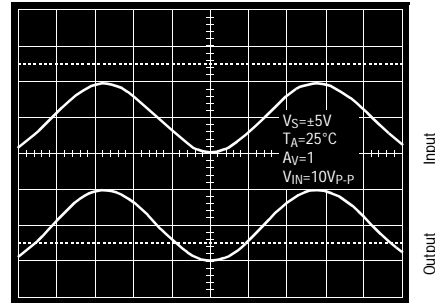

Figure 1. Operation with Rail-to-Rail Input and Output

Short Circuit Current Limit

The EL5220C and EL5420C will limit the short circuit current to \pm 120mA if the output is directly shorted to the positive or the negative supply. If an output is shorted indefinitely, the power dissipation could easily increase such that the device may be damaged. Maximum reliability is maintained if the output continuous current never exceeds \pm 30 mA. This limit is set by the design of the internal metal interconnects.

Output Phase Reversal

The EL5220C and EL5420C are immune to phase reversal as long as the input voltage is limited from (V_{S-}) -0.5V to (V_{S+}) +0.5V. Figure 2 shows a photo of the output of the device with the input voltage driven beyond the supply rails. Although the device's output will not change phase, the input's overvoltage should be avoided. If an input voltage exceeds supply voltage by more than 0.6V, electrostatic protection diodes placed in the input stage of the device begin to conduct and over-voltage damage could occur.

EL5220C, EL5420C

12MHz Rail-to-Rail Input-Output Op Amps

EL5220C, EL5420C

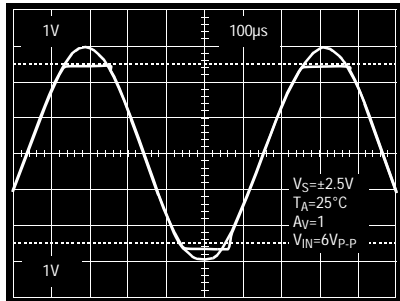

Figure 2. Operation with Beyond-the-Rails Input

Power Dissipation

With the high-output drive capability of the EL5220C and EL5420C amplifiers, it is possible to exceed the 125°C “absolute-maximum junction temperature” under certain load current conditions. Therefore, it is important to calculate the maximum junction temperature for the application to determine if load conditions need to be modified for the amplifier to remain in the safe operating area.

The maximum power dissipation allowed in a package is determined according to:

$$P_{DMAX} = \frac{T_{JMAX} - T_{AMAX}}{\theta_{JA}}$$

where:

T_{JMAX} = Maximum Junction Temperature

T_{AMAX} = Maximum Ambient Temperature

θ_{JA} = Thermal Resistance of the Package

P_{DMAX} = Maximum Power Dissipation in the Package

The maximum power dissipation actually produced by an IC is the total quiescent supply current times the total power supply voltage, plus the power in the IC due to the loads, or:

$$P_{DMAX} = \sum i \times [V_S \times I_{SMAX} + (V_S + -V_{OUTi}) \times I_{LOADi}]$$

when sourcing, and:

$$P_{DMAX} = \sum i \times [V_S \times I_{SMAX} + (V_{OUTi} - V_S) \times I_{LOADi}]$$

when sinking.

where

$i = 1$ to 2 for Dual and 1 to 4 for Quad

V_S = Total Supply Voltage

I_{SMAX} = Maximum Supply Current Per Amplifier

V_{OUTi} = Maximum Output Voltage of the Application

I_{LOADi} = Load Current

If we set the two P_{DMAX} equations equal to each other, we can solve for R_{LOADi} to avoid device overheat. Figures 3, 4, and 5 provide a convenient way to see if the device will overheat. The maximum safe power dissipation can be found graphically, based on the package type and the ambient temperature. By using the previous equation, it is a simple matter to see if P_{DMAX} exceeds the device's power derating curves. To ensure proper operation, it is important to observe the recommended derating curves in Figures 3, 4, and 5.

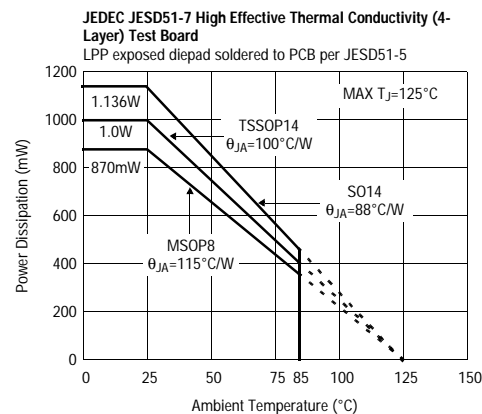

Figure 3. Package Power Dissipation vs Ambient Temperature

EL5220C, EL5420C

12MHz Rail-to-Rail Input-Output Op Amps

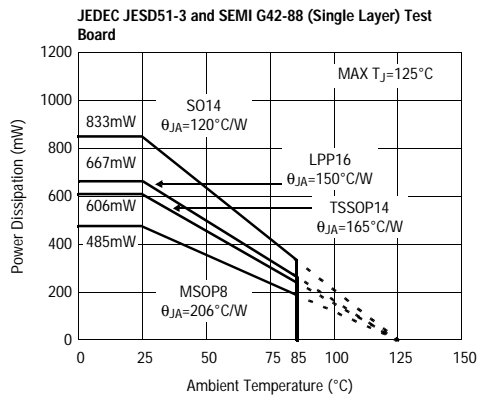

Figure 4. Package Power Dissipation vs Ambient Temperature

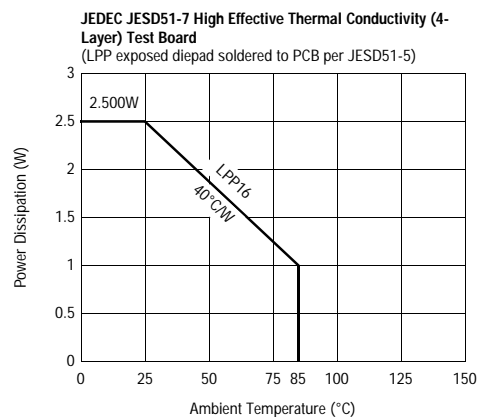

Figure 5. Package Power Dissipation vs Ambient Temperature

Unused Amplifiers

It is recommended that any unused amplifiers in a dual and a quad package be configured as a unity gain follower. The inverting input should be directly connected to the output and the non-inverting input tied to the ground plane.

Driving Capacitive Loads

The EL5220C and EL5420C can drive a wide range of capacitive loads. As load capacitance increases, however, the -3dB bandwidth of the device will decrease and

the peaking increase. The amplifiers drive 10pF loads in parallel with 10kΩ with just 1.5dB of peaking, and 100pF with 6.4dB of peaking. If less peaking is desired in these applications, a small series resistor (usually between 5Ω and 50Ω) can be placed in series with the output. However, this will obviously reduce the gain slightly. Another method of reducing peaking is to add a “snubber” circuit at the output. A snubber is a shunt load consisting of a resistor in series with a capacitor. Values of 150Ω and 10nF are typical. The advantage of a snubber is that it does not draw any DC load current or reduce the gain

Power Supply Bypassing and Printed Circuit Board Layout

The EL5220C and EL5420C can provide gain at high frequency. As with any high-frequency device, good printed circuit board layout is necessary for optimum performance. Ground plane construction is highly recommended, lead lengths should be as short as possible and the power supply pins must be well bypassed to reduce the risk of oscillation. For normal single supply operation, where the V_{S-} pin is connected to ground, a 0.1μF ceramic capacitor should be placed from V_{S+} to pin to V_{S-} pin. A 4.7μF tantalum capacitor should then be connected in parallel, placed in the region of the amplifier. One 4.7μF capacitor may be used for multiple devices. This same capacitor combination should be placed at each supply pin to ground if split supplies are to be used.

EL5220C, EL5420C**12MHz Rail-to-Rail Input-Output Op Amps****General Disclaimer**

Specifications contained in this data sheet are in effect as of the publication date shown. Elantec, Inc. reserves the right to make changes in the circuitry or specifications contained herein at any time without notice. Elantec, Inc. assumes no responsibility for the use of any circuits described herein and makes no representations that they are free from patent infringement.

élantec

HIGH PERFORMANCE ANALOG INTEGRATED CIRCUITS

Elantec Semiconductor, Inc.

675 Trade Zone Blvd.

Milpitas, CA 95035

Telephone: (408) 945-1323

(888) ELANTEC

Fax: (408) 945-9305

European Office: +44-118-977-6020

Japan Technical Center: +81-45-682-5820

WARNING - Life Support Policy

Elantec, Inc. products are not authorized for and should not be used within Life Support Systems without the specific written consent of Elantec, Inc. Life Support systems are equipment intended to support or sustain life and whose failure to perform when properly used in accordance with instructions provided can be reasonably expected to result in significant personal injury or death. Users contemplating application of Elantec, Inc. Products in Life Support Systems are requested to contact Elantec, Inc. factory headquarters to establish suitable terms & conditions for these applications. Elantec, Inc.'s warranty is limited to replacement of defective components and does not cover injury to persons or property or other consequential damages.