

TC74LVX00F, TC74LVX00FN, TC74LVX00FT

Quad 2-Input NAND Gate

The TC74LVX00F/FN/FT is a high-speed CMOS 2-input NAND gate fabricated with silicon gate CMOS technology. Designed for use in 3-V systems, it achieves high-speed operation while maintaining the CMOS low power dissipation.

This device is suitable for low-voltage and battery operated systems.

The internal circuit is composed of 3 stages including buffer output, which provide high noise immunity and stable output.

An input protection circuit ensures that 0 to 5.5V can be applied to the input pins without regard to the supply voltage. This device can be used to interface 5V to 3V systems and two supply systems such as battery back up. This circuit prevents device destruction due to mismatched supply and input voltages.

Features

- High-speed: $t_{pd} = 4.1 \text{ ns (typ.) (} V_{CC} = 3.3 \text{ V)}$
- Low power dissipation: $I_{CC} = 2 \mu\text{A (max) (} T_a = 25^\circ\text{C)}$
- Input voltage level: $V_{IL} = 0.8 \text{ V (max) (} V_{CC} = 3 \text{ V)}$
 $V_{IH} = 2.0 \text{ V (min) (} V_{CC} = 3 \text{ V)}$
- Power-down protection provided on all inputs
- Balanced propagation delays: $t_{pLH} \approx t_{pHL}$
- Low noise: $V_{OLP} = 0.5 \text{ V (max)}$
- Pin and function compatible with 74HC00

Note: xxxFN (JEDEC SOP) is not available in Japan.

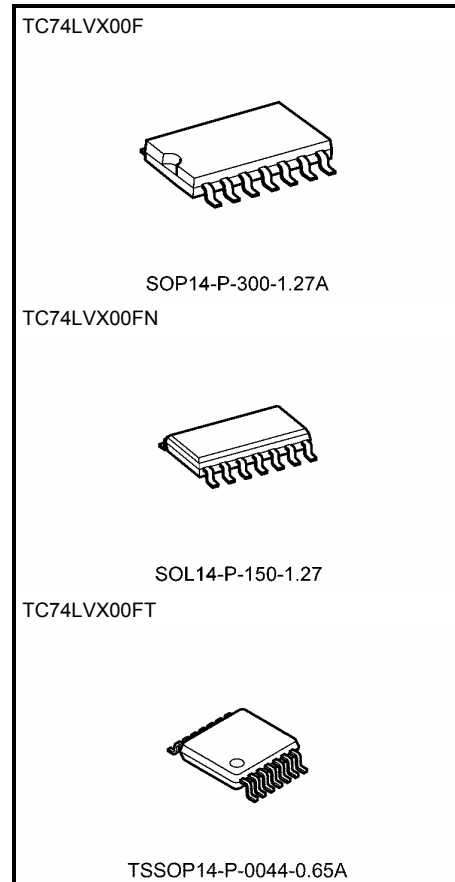

| | |
|----------------------|-----------------|
| Weight | |
| SOP14-P-300-1.27A | : 0.18 g (typ.) |
| SOL14-P-150-1.27 | : 0.12 g (typ.) |
| TSSOP14-P-0044-0.65A | : 0.06 g (typ.) |

Pin Assignment (top view)

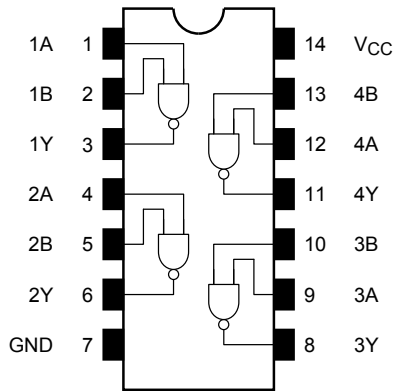

IEC Logic Symbol

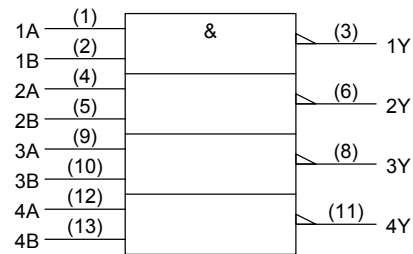

Truth Table

| Input | | Output |
|-------|---|--------|
| A | B | Y |
| L | L | H |
| L | H | H |
| H | L | H |
| H | H | L |

Absolute Maximum Ratings (Note)

| Characteristics | Symbol | Rating | Unit |
|-----------------------------|-----------|------------------------|-------------|
| Supply voltage range | V_{CC} | -0.5 to 7.0 | V |
| DC input voltage | V_{IN} | -0.5 to 7.0 | V |
| DC output voltage | V_{OUT} | -0.5 to $V_{CC} + 0.5$ | V |
| Input diode current | I_{IK} | -20 | mA |
| Output diode current | I_{OK} | ± 20 | mA |
| DC output current | I_{OUT} | ± 25 | mA |
| DC V_{CC} /ground current | I_{CC} | ± 50 | mA |
| Power dissipation | P_D | 180 | mW |
| Storage temperature | T_{stg} | -65 to 150 | $^{\circ}C$ |

Note: Exceeding any of the absolute maximum ratings, even briefly, lead to deterioration in IC performance or even destruction.

Using continuously under heavy loads (e.g. the application of high temperature/current/voltage and the significant change in temperature, etc.) may cause this product to decrease in the reliability significantly even if the operating conditions (i.e. operating temperature/current/voltage, etc.) are within the absolute maximum ratings and the operating ranges.

Please design the appropriate reliability upon reviewing the Toshiba Semiconductor Reliability Handbook ("Handling Precautions"/"Derating Concept and Methods") and individual reliability data (i.e. reliability test report and estimated failure rate, etc).

Operating Ranges (Note)

| Characteristics | Symbol | Rating | Unit |
|--------------------------|-----------|---------------|------|
| Supply voltage | V_{CC} | 2.0 to 3.6 | V |
| Input voltage | V_{IN} | 0 to 5.5 | V |
| Output voltage | V_{OUT} | 0 to V_{CC} | V |
| Operating temperature | T_{opr} | -40 to 85 | °C |
| Input rise and fall time | dt/dv | 0 to 100 | ns/V |

Note: The operating ranges must be maintained to ensure the normal operation of the device.
Unused inputs must be tied to either V_{CC} or GND.

Electrical Characteristics

DC Characteristics

| Characteristics | | Symbol | Test Condition | Ta = 25°C | | | Ta = -40 to 85°C | | Unit | | | | |
|--------------------------|---------|----------|----------------------------------|----------------------|-------------------|---------------------|------------------|------|------|------|----|---|------|
| | | | | V _{CC} (V) | Min | Typ. | Max | Min | | Max | | | |
| Input voltage | H-level | V_{IH} | — | 2.0 | 1.5 | — | — | 1.5 | — | V | | | |
| | | | | 3.0 | 2.0 | — | — | 2.0 | — | | | | |
| | | | | 3.6 | 2.4 | — | — | 2.4 | — | | | | |
| | L-level | V_{IL} | | 2.0 | — | — | 0.5 | — | 0.5 | | | | |
| | | | | 3.0 | — | — | 0.8 | — | 0.8 | | | | |
| | | | | 3.6 | — | — | 0.8 | — | 0.8 | | | | |
| Output voltage | H-level | V_{OH} | $V_{IN} = V_{IH}$ or V_{IL} | $I_{OH} = -50 \mu A$ | 2.0 | 1.9 | 2.0 | — | 1.9 | — | V | | |
| | | | | $I_{OH} = -50 \mu A$ | 3.0 | 2.9 | 3.0 | — | 2.9 | — | | | |
| | | | | $I_{OH} = -4 mA$ | 3.0 | 2.58 | — | — | 2.48 | — | | | |
| | L-level | | | V_{OL} | $V_{IN} = V_{IH}$ | $I_{OL} = 50 \mu A$ | 2.0 | — | 0 | 0.1 | | — | 0.1 |
| | | | | | | $I_{OL} = 50 \mu A$ | 3.0 | — | 0 | 0.1 | | — | 0.1 |
| | | | | | | $I_{OL} = 4 mA$ | 3.0 | — | — | 0.36 | | — | 0.44 |
| Input leakage current | | I_{IN} | $V_{IN} = 5.5 V$ or GND | 3.6 | | — | — | ±0.1 | — | ±1.0 | μA | | |
| Quiescent supply current | | I_{CC} | $V_{IN} = V_{CC}$ or GND | 3.6 | | — | — | 2.0 | — | 20.0 | μA | | |

AC Characteristics (input: $t_r = t_f = 3$ ns)

| Characteristics | Symbol | Test Condition | Ta = 25°C | | | Ta = -40 to 85°C | | Unit | | |
|-------------------------------|-------------------|----------------|---------------------|---------------------|-----|------------------|------|------|------|-----|
| | | | V _{CC} (V) | C _L (pF) | Min | Typ. | Max | | Min | Max |
| Propagation delay time | t _{pLH} | — | 2.7 | 15 | — | 5.4 | 10.1 | 1.0 | 12.5 | ns |
| | | | | 50 | — | 7.9 | 13.6 | 1.0 | 16.0 | |
| | 3.3 ± 0.3 | | 15 | — | 4.1 | 6.2 | 1.0 | 7.5 | | |
| | | | 50 | — | 6.6 | 9.7 | 1.0 | 11.0 | | |
| Output to output skew | t _{osLH} | (Note 1) | 2.7 | 50 | — | — | 1.5 | — | 1.5 | ns |
| | t _{osHL} | | | | — | — | 1.5 | — | 1.5 | |
| Input capacitance | C _{IN} | (Note 2) | | — | 4 | 10 | — | 10 | pF | |
| Power dissipation capacitance | C _{PD} | (Note 3) | | — | 19 | — | — | — | pF | |

Note 1: Parameter guaranteed by design.
 $(t_{osLH} = |t_{pLHm} - t_{pLHn}|, t_{osHL} = |t_{pHLm} - t_{pHLn}|)$

Note 2: Parameter guaranteed by design.

Note 3: C_{PD} is defined as the value of the internal equivalent capacitance which is calculated from the operating current consumption.

Average operating current can be obtained by the equation:
 $I_{CC(opr)} = C_{PD} \cdot V_{CC} \cdot f_{IN} + I_{CC}/4$ (per gate)

Noise Characteristics (Ta = 25°C, input: $t_r = t_f = 3$ ns, C_L = 50 pF)

| Characteristics | Symbol | Test Condition | V _{CC} (V) | Typ. | Limit | Unit |
|--|------------------|----------------|---------------------|------|-------|------|
| | | | | | | |
| Quiet output minimum dynamic V _{OL} | V _{OLV} | — | 3.3 | -0.3 | -0.5 | V |
| Minimum high level dynamic input voltage V _{IH} | V _{IHD} | — | 3.3 | — | 2.0 | V |
| Maximum low level dynamic input voltage V _{IL} | V _{ILD} | — | 3.3 | — | 0.8 | V |

Input Equivalent Circuit

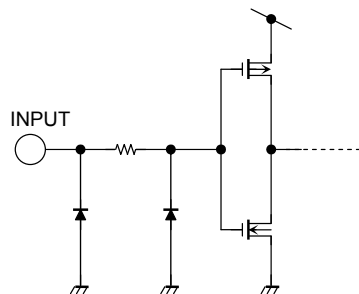

Package Dimensions

SOP14-P-300-1.27A

Unit: mm

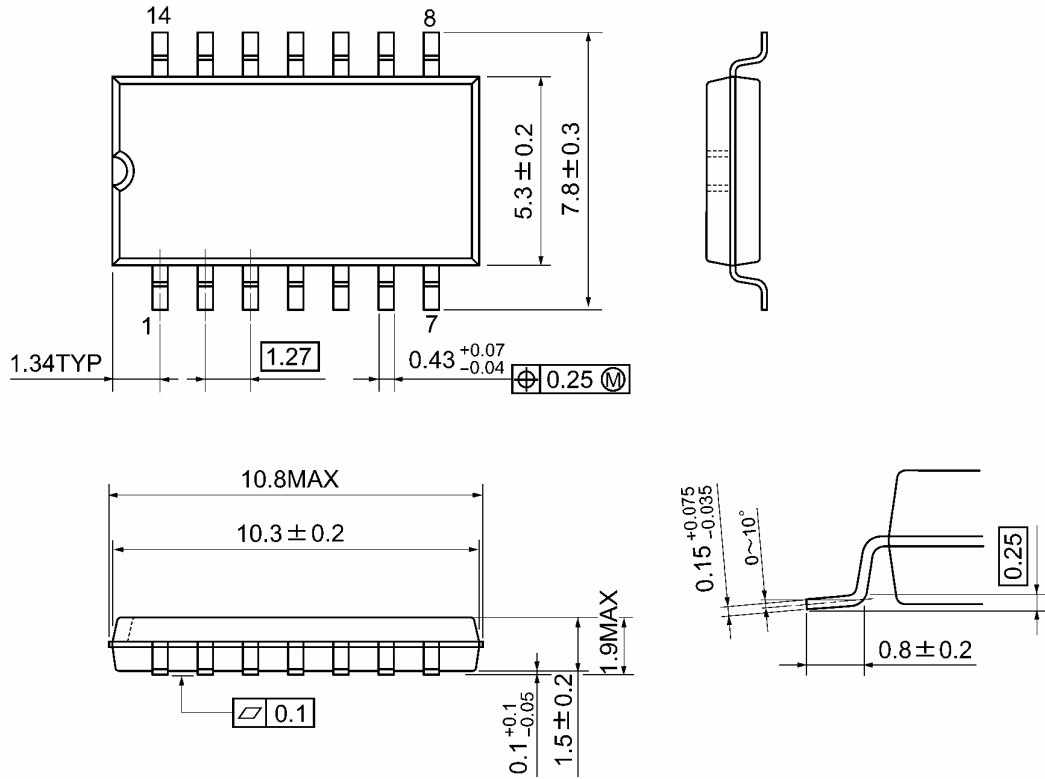

Weight: 0.18 g (typ.)

Package Dimensions (Note)

SOL14-P-150-1.27

Unit : mm

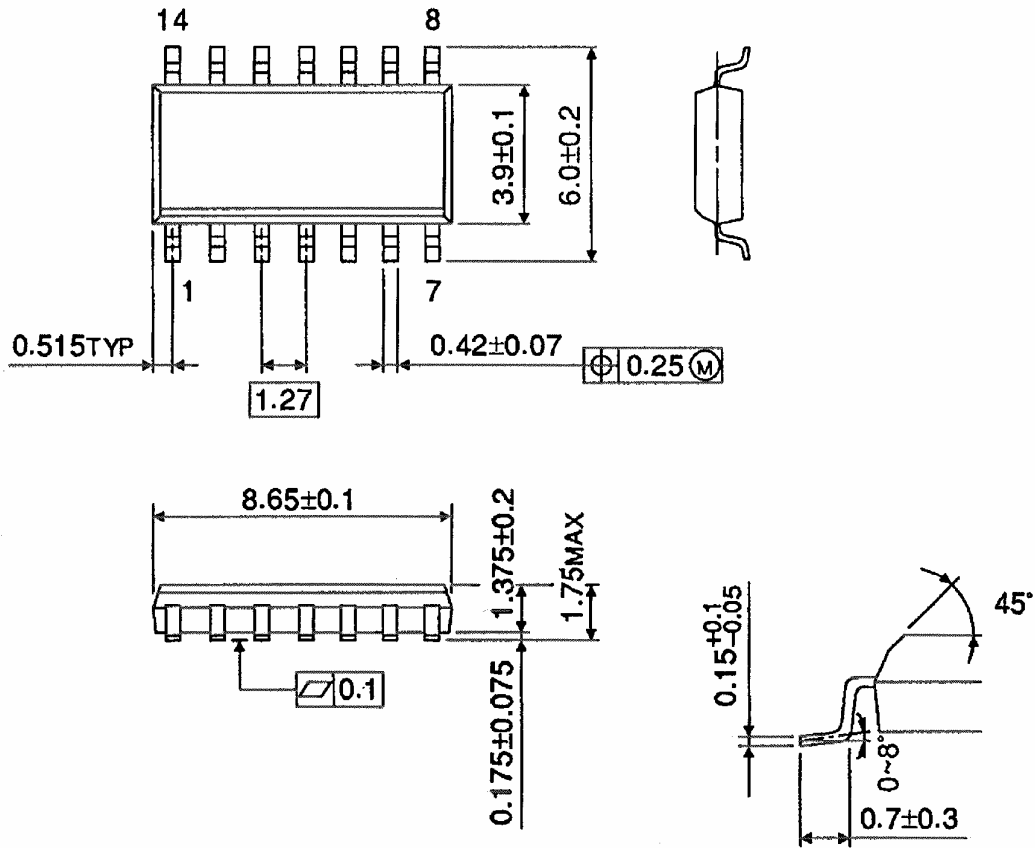

Note: This package is not available in Japan.

Weight: 0.12 g (typ.)

Package Dimensions

TSSOP14-P-0044-0.65A

Unit: mm

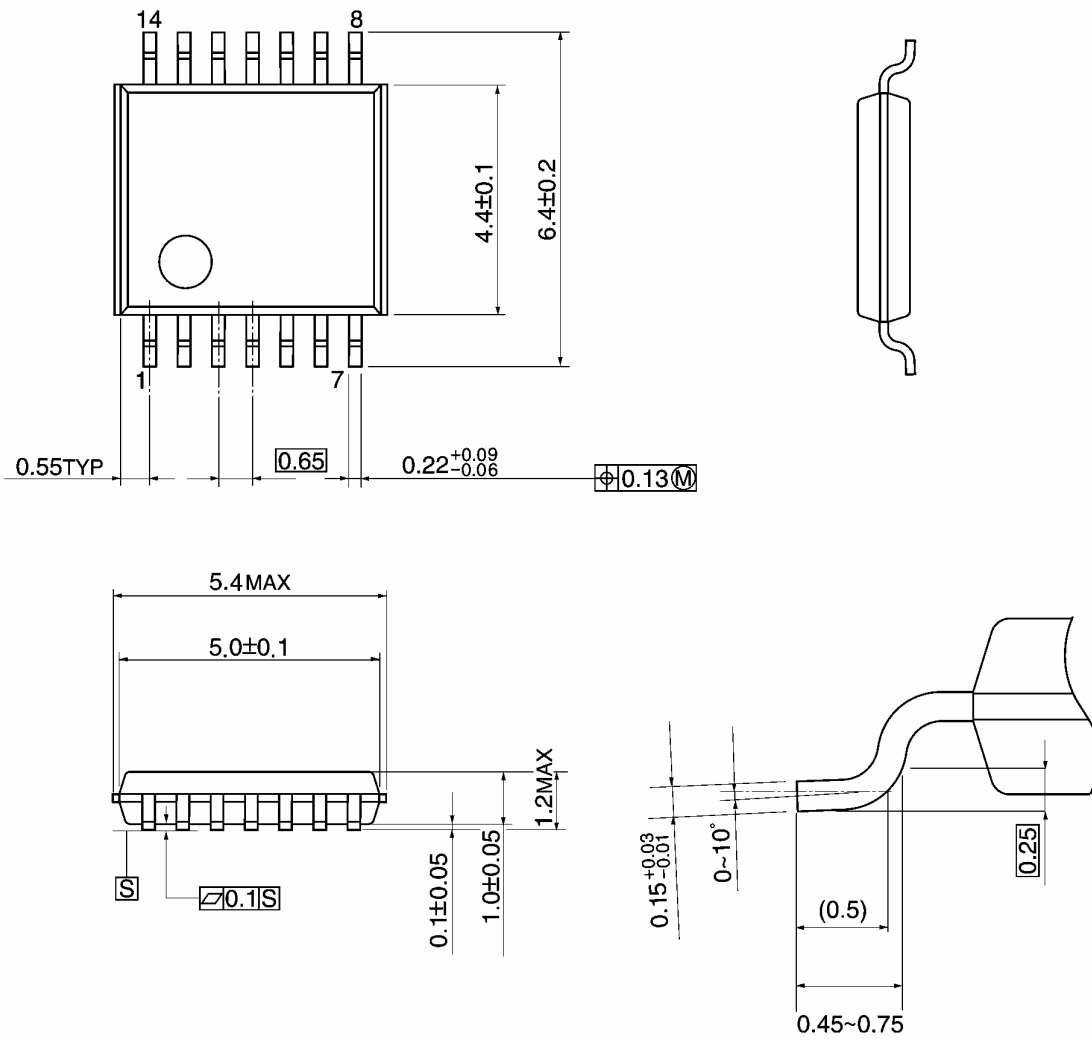

Weight: 0.06 g (typ.)

RESTRICTIONS ON PRODUCT USE

20070701-EN GENERAL

- The information contained herein is subject to change without notice.
- TOSHIBA is continually working to improve the quality and reliability of its products. Nevertheless, semiconductor devices in general can malfunction or fail due to their inherent electrical sensitivity and vulnerability to physical stress. It is the responsibility of the buyer, when utilizing TOSHIBA products, to comply with the standards of safety in making a safe design for the entire system, and to avoid situations in which a malfunction or failure of such TOSHIBA products could cause loss of human life, bodily injury or damage to property.
In developing your designs, please ensure that TOSHIBA products are used within specified operating ranges as set forth in the most recent TOSHIBA products specifications. Also, please keep in mind the precautions and conditions set forth in the "Handling Guide for Semiconductor Devices," or "TOSHIBA Semiconductor Reliability Handbook" etc.
- The TOSHIBA products listed in this document are intended for usage in general electronics applications (computer, personal equipment, office equipment, measuring equipment, industrial robotics, domestic appliances, etc.). These TOSHIBA products are neither intended nor warranted for usage in equipment that requires extraordinarily high quality and/or reliability or a malfunction or failure of which may cause loss of human life or bodily injury ("Unintended Usage"). Unintended Usage include atomic energy control instruments, airplane or spaceship instruments, transportation instruments, traffic signal instruments, combustion control instruments, medical instruments, all types of safety devices, etc.. Unintended Usage of TOSHIBA products listed in this document shall be made at the customer's own risk.
- The products described in this document shall not be used or embedded to any downstream products of which manufacture, use and/or sale are prohibited under any applicable laws and regulations.
- The information contained herein is presented only as a guide for the applications of our products. No responsibility is assumed by TOSHIBA for any infringements of patents or other rights of the third parties which may result from its use. No license is granted by implication or otherwise under any patents or other rights of TOSHIBA or the third parties.
- Please contact your sales representative for product-by-product details in this document regarding RoHS compatibility. Please use these products in this document in compliance with all applicable laws and regulations that regulate the inclusion or use of controlled substances. Toshiba assumes no liability for damage or losses occurring as a result of noncompliance with applicable laws and regulations.