

TOSHIBA CMOS Digital Integrated Circuit Silicon Monolithic

# TC74VCX162827FT

## Low-Voltage 20-Bit Bus Buffer with 3.6-V Tolerant Inputs and Outputs

The TC74VCX162827FT is a high-performance CMOS 20-bit bus buffer. Designed for use in 1.8-V, 2.5-V or 3.3-V systems, it achieves high-speed operation while maintaining the CMOS low power dissipation.

It is also designed with overvoltage tolerant inputs and outputs up to 3.6 V.

The TC74VCX162827FT is composed of two 10-bit sections with separate output-enable signals. For either 10-bit buffer section, the two output-enable ( $\overline{1OE1}$  and  $\overline{1OE2}$  or  $2\overline{OE1}$  and  $2\overline{OE2}$ ) inputs must both be low for the corresponding Y outputs to be active. When the  $\overline{OE}$  input is high, the outputs are in a high-impedance state. This device is designed to be used with 3-state memory address drivers, etc.

The 26- $\Omega$  series resistor helps reducing output overshoot and undershoot without external resistor.

All inputs are equipped with protection circuits against static discharge.

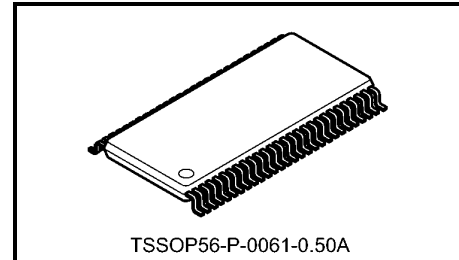

Weight: 0.25 g (typ.)

### Features

- 26- $\Omega$  series resistors on outputs
- Low-voltage operation:  $V_{CC} = 1.8$  to 3.6 V
- High-speed operation:  $t_{pd} = 3.4$  (max) ( $V_{CC} = 3.0$  to 3.6 V)  
                                   :  $t_{pd} = 4.1$  (max) ( $V_{CC} = 2.3$  to 2.7 V)  
                                   :  $t_{pd} = 8.2$  (max) ( $V_{CC} = 1.8$  V)
- Output current:  $I_{OH}/I_{OL} = \pm 12$  mA (min) ( $V_{CC} = 3.0$  V)  
                                   :  $I_{OH}/I_{OL} = \pm 8$  mA (min) ( $V_{CC} = 2.3$  V)  
                                   :  $I_{OH}/I_{OL} = \pm 4$  mA (min) ( $V_{CC} = 1.8$  V)
- Latch-up performance:  $-300$  mA
- ESD performance: Machine model  $\geq \pm 200$  V  
                                   Human body model  $\geq \pm 2000$  V
- Package: TSSOP
- 3.6-V tolerant function and power-down protection provided on all inputs and outputs

## Pin Assignment (top view)

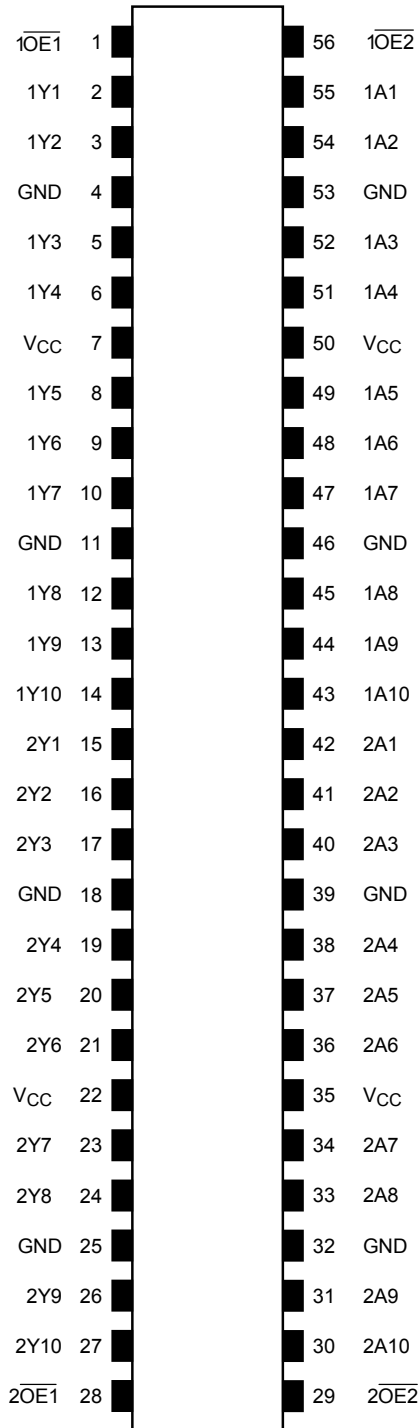

## IEC Logic Symbol

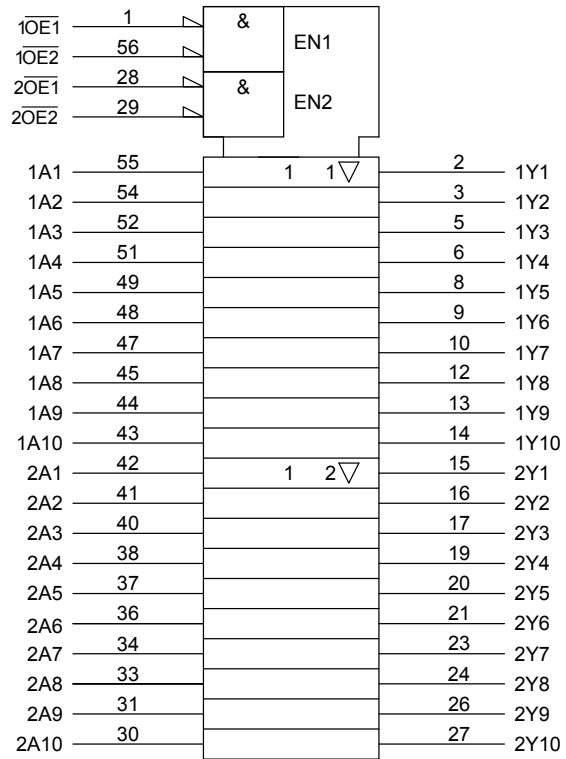

## Truth Table (each 10-bit latch)

Inputs			Outputs Y
$\overline{OE1}$	$\overline{OE2}$	A	
L	L	L	L
L	L	H	H
H	X	X	Z
X	H	X	Z

X: Don't care

Z: High impedance

## System Diagram

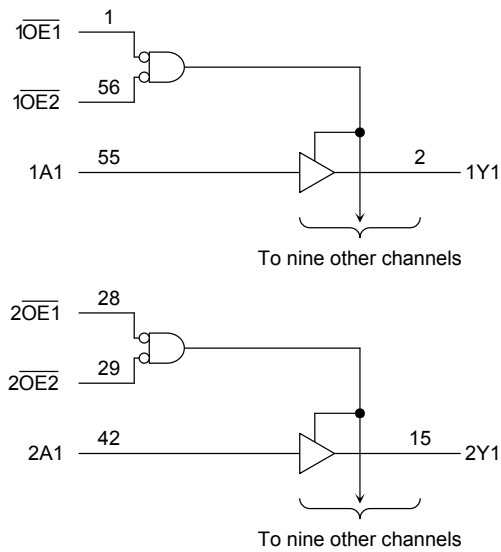

**Absolute Maximum Ratings (Note 1)**

Characteristics	Symbol	Rating	Unit
Power supply voltage	$V_{CC}$	-0.5 to 4.6	V
DC input voltage	$V_{IN}$	-0.5 to 4.6	V
DC output voltage	$V_{OUT}$	-0.5 to 4.6 (Note 2)	V
		-0.5 to $V_{CC} + 0.5$ (Note 3)	
Input diode current	$I_{IK}$	-50	mA
Output diode current	$I_{OK}$	$\pm 50$ (Note 4)	mA
DC output current	$I_{OUT}$	$\pm 50$	mA
Power dissipation	$P_D$	400	mW
DC $V_{CC}$ /ground current per supply pin	$I_{CC}/I_{GND}$	$\pm 100$	mA
Storage temperature	$T_{stg}$	-65 to 150	$^{\circ}C$

Note 1: Exceeding any of the absolute maximum ratings, even briefly, lead to deterioration in IC performance or even destruction.

Using continuously under heavy loads (e.g. the application of high temperature/current/voltage and the significant change in temperature, etc.) may cause this product to decrease in the reliability significantly even if the operating conditions (i.e. operating temperature/current/voltage, etc.) are within the absolute maximum ratings and the operating ranges.

Please design the appropriate reliability upon reviewing the Toshiba Semiconductor Reliability Handbook ("Handling Precautions"/"Derating Concept and Methods") and individual reliability data (i.e. reliability test report and estimated failure rate, etc).

Note 2: OFF state

Note 3: High or low state.  $I_{OUT}$  absolute maximum rating must be observed.

Note 4:  $V_{OUT} < GND, V_{OUT} > V_{CC}$

**Operating Ranges (Note 1)**

Characteristics	Symbol	Rating	Unit
Power supply voltage	$V_{CC}$	1.8 to 3.6	V
		1.2 to 3.6 (Note 2)	
Input voltage	$V_{IN}$	-0.3 to 3.6	V
Output voltage	$V_{OUT}$	0 to 3.6 (Note 3)	V
		0 to $V_{CC}$ (Note 4)	
Output current	$I_{OH}/I_{OL}$	$\pm 12$ (Note 5)	mA
		$\pm 8$ (Note 6)	
		$\pm 4$ (Note 7)	
Operating temperature	$T_{opr}$	-40 to 85	$^{\circ}C$
Input rise and fall time	$dt/dv$	0 to 10 (Note 8)	ns/V

Note 1: The operating ranges must be maintained to ensure the normal operation of the device. Unused inputs must be tied to either VCC or GND.

Note 2: Data retention only

Note 3: OFF state

Note 4: High or low state

Note 5:  $V_{CC} = 3.0$  to 3.6 V

Note 6:  $V_{CC} = 2.3$  to 2.7 V

Note 7:  $V_{CC} = 1.8$  V

Note 8:  $V_{IN} = 0.8$  to 2.0 V,  $V_{CC} = 3.0$  V

**Electrical Characteristics**

**DC Characteristics (Ta = -40 to 85°C, 2.7 V < VCC ≤ 3.6 V)**

Characteristics		Symbol	Test Condition		VCC (V)	Min	Max	Unit
Input voltage	H-level	V <sub>IH</sub>	—		2.7 to 3.6	2.0	—	V
	L-level	V <sub>IL</sub>	—		2.7 to 3.6	—	0.8	
Output voltage	H-level	V <sub>OH</sub>	V <sub>IN</sub> = V <sub>IH</sub> or V <sub>IL</sub>	I <sub>OH</sub> = -100 μA	2.7 to 3.6	V <sub>CC</sub> - 0.2	—	V
				I <sub>OH</sub> = -6 mA	2.7	2.2	—	
				I <sub>OH</sub> = -8 mA	3.0	2.4	—	
				I <sub>OH</sub> = -12 mA	3.0	2.2	—	
	L-level	V <sub>OL</sub>	V <sub>IN</sub> = V <sub>IH</sub> or V <sub>IL</sub>	I <sub>OL</sub> = 100 μA	2.7 to 3.6	—	0.2	
				I <sub>OL</sub> = 6 mA	2.7	—	0.4	
				I <sub>OL</sub> = 8 mA	3.0	—	0.55	
				I <sub>OL</sub> = 12 mA	3.0	—	0.8	
Input leakage current		I <sub>IN</sub>	V <sub>IN</sub> = 0 to 3.6 V		2.7 to 3.6	—	±5.0	μA
3-state output OFF state current		I <sub>OZ</sub>	V <sub>IN</sub> = V <sub>IH</sub> or V <sub>IL</sub> V <sub>OUT</sub> = 0 to 3.6 V		2.7 to 3.6	—	±10.0	μA
Power-off leakage current		I <sub>OFF</sub>	V <sub>IN</sub> , V <sub>OUT</sub> = 0 to 3.6 V		0	—	10.0	μA
Quiescent supply current		I <sub>CC</sub>	V <sub>IN</sub> = V <sub>CC</sub> or GND		2.7 to 3.6	—	20.0	μA
			V <sub>CC</sub> ≤ (V <sub>IN</sub> , V <sub>OUT</sub> ) ≤ 3.6 V		2.7 to 3.6	—	±20.0	
Increase in I <sub>CC</sub> per input		ΔI <sub>CC</sub>	V <sub>IH</sub> = V <sub>CC</sub> - 0.6 V		2.7 to 3.6	—	750	

**DC Characteristics (Ta = -40 to 85°C, 2.3 V ≤ VCC ≤ 2.7 V)**

Characteristics		Symbol	Test Condition		VCC (V)	Min	Max	Unit
Input voltage	H-level	V <sub>IH</sub>	—		2.3 to 2.7	1.6	—	V
	L-level	V <sub>IL</sub>	—		2.3 to 2.7	—	0.7	
Output voltage	H-level	V <sub>OH</sub>	V <sub>IN</sub> = V <sub>IH</sub> or V <sub>IL</sub>	I <sub>OH</sub> = -100 μA	2.3 to 2.7	V <sub>CC</sub> - 0.2	—	V
				I <sub>OH</sub> = -4 mA	2.3	2.0	—	
				I <sub>OH</sub> = -6 mA	2.3	1.8	—	
				I <sub>OH</sub> = -8 mA	2.3	1.7	—	
	L-level	V <sub>OL</sub>	V <sub>IN</sub> = V <sub>IH</sub> or V <sub>IL</sub>	I <sub>OL</sub> = 100 μA	2.3 to 2.7	—	0.2	
				I <sub>OL</sub> = 6 mA	2.3	—	0.4	
				I <sub>OL</sub> = 8 mA	2.3	—	0.6	
Input leakage current		I <sub>IN</sub>	V <sub>IN</sub> = 0 to 3.6 V		2.3 to 2.7	—	±5.0	μA
3-state output OFF state current		I <sub>OZ</sub>	V <sub>IN</sub> = V <sub>IH</sub> or V <sub>IL</sub> V <sub>OUT</sub> = 0 to 3.6 V		2.3 to 2.7	—	±10.0	μA
Power-off leakage current		I <sub>OFF</sub>	V <sub>IN</sub> , V <sub>OUT</sub> = 0 to 3.6 V		0	—	10.0	μA
Quiescent supply current		I <sub>CC</sub>	V <sub>IN</sub> = V <sub>CC</sub> or GND		2.3 to 2.7	—	20.0	μA
			V <sub>CC</sub> ≤ (V <sub>IN</sub> , V <sub>OUT</sub> ) ≤ 3.6 V		2.3 to 2.7	—	±20.0	

## DC Characteristics (Ta = -40 to 85°C, 1.8 V ≤ VCC < 2.3 V)

Characteristics		Symbol	Test Condition		VCC (V)	Min	Max	Unit
Input voltage	H-level	V <sub>IH</sub>	—		1.8 to 2.3	0.7 × V <sub>CC</sub>	—	V
	L-level	V <sub>IL</sub>	—		1.8 to 2.3	—	0.2 × V <sub>CC</sub>	
Output voltage	H-level	V <sub>OH</sub>	V <sub>IN</sub> = V <sub>IH</sub> or V <sub>IL</sub>	I <sub>OH</sub> = -100 μA	1.8	V <sub>CC</sub> - 0.2	—	V
				I <sub>OH</sub> = -4 mA	1.8	1.4	—	
	L-level	V <sub>OL</sub>	V <sub>IN</sub> = V <sub>IH</sub> or V <sub>IL</sub>	I <sub>OL</sub> = 100 μA	1.8	—	0.2	
				I <sub>OL</sub> = 4 mA	1.8	—	0.3	
Input leakage current		I <sub>IN</sub>	V <sub>IN</sub> = 0 to 3.6 V		1.8	—	±5.0	μA
3-state output OFF state current		I <sub>OZ</sub>	V <sub>IN</sub> = V <sub>IH</sub> or V <sub>IL</sub> V <sub>OUT</sub> = 0 to 3.6 V		1.8	—	±10.0	μA
Power-off leakage current		I <sub>OFF</sub>	V <sub>IN</sub> , V <sub>OUT</sub> = 0 to 3.6 V		0	—	10.0	μA
Quiescent supply current		I <sub>CC</sub>	V <sub>IN</sub> = V <sub>CC</sub> or GND		1.8	—	20.0	μA
			V <sub>CC</sub> ≤ (V <sub>IN</sub> , V <sub>OUT</sub> ) ≤ 3.6 V		1.8	—	±20.0	

## AC Characteristics (Ta = -40 to 85°C, input: t<sub>r</sub> = t<sub>f</sub> = 2.0 ns, C<sub>L</sub> = 30 pF, R<sub>L</sub> = 500 Ω) (Note 1)

Characteristics		Symbol	Test Condition		VCC (V)	Min	Max	Unit
Propagation delay time	t <sub>pLH</sub> t <sub>pHL</sub>	Figure 1, Figure 2			1.8	1.5	8.2	ns
					2.5 ± 0.2	1.0	4.1	
					3.3 ± 0.3	0.8	3.4	
3-state output enable time	t <sub>pZL</sub> t <sub>pZH</sub>	Figure 1, Figure 3			1.8	1.5	9.8	ns
					2.5 ± 0.2	1.0	5.9	
					3.3 ± 0.3	0.8	4.3	
3-state output disable time	t <sub>pLZ</sub> t <sub>pHZ</sub>	Figure 1, Figure 3			1.8	1.5	8.8	ns
					2.5 ± 0.2	1.0	4.9	
					3.3 ± 0.3	0.8	4.3	
Output to output skew	t <sub>osLH</sub> t <sub>osHL</sub>	(Note 2)			1.8	—	0.5	ns
					2.5 ± 0.2	—	0.5	
					3.3 ± 0.3	—	0.5	

Note 1: For C<sub>L</sub> = 50 pF, add approximately 300 ps to the AC maximum specification.

Note 2: Parameter guaranteed by design.

$$(t_{osLH} = |t_{pLHm} - t_{pLHn}|, t_{osHL} = |t_{pHLm} - t_{pHLn}|)$$

## Dynamic Switching Characteristics

( $T_a = 25^\circ\text{C}$ , input:  $t_r = t_f = 2.0 \text{ ns}$ ,  $C_L = 30 \text{ pF}$ ,  $R_L = 500 \Omega$ )

Characteristics	Symbol	Test Condition	V <sub>CC</sub> (V)	Typ.	Unit
Quiet output maximum dynamic V <sub>OL</sub>	V <sub>OLP</sub>	V <sub>IH</sub> = 1.8 V, V <sub>IL</sub> = 0 V (Note)	1.8	0.15	V
		V <sub>IH</sub> = 2.5 V, V <sub>IL</sub> = 0 V (Note)	2.5	0.25	
		V <sub>IH</sub> = 3.3 V, V <sub>IL</sub> = 0 V (Note)	3.3	0.35	
Quiet output minimum dynamic V <sub>OL</sub>	V <sub>OLV</sub>	V <sub>IH</sub> = 1.8 V, V <sub>IL</sub> = 0 V (Note)	1.8	-0.15	V
		V <sub>IH</sub> = 2.5 V, V <sub>IL</sub> = 0 V (Note)	2.5	-0.25	
		V <sub>IH</sub> = 3.3 V, V <sub>IL</sub> = 0 V (Note)	3.3	-0.35	
Quiet output minimum dynamic V <sub>OH</sub>	V <sub>OHV</sub>	V <sub>IH</sub> = 1.8 V, V <sub>IL</sub> = 0 V (Note)	1.8	1.55	V
		V <sub>IH</sub> = 2.5 V, V <sub>IL</sub> = 0 V (Note)	2.5	2.05	
		V <sub>IH</sub> = 3.3 V, V <sub>IL</sub> = 0 V (Note)	3.3	2.65	

Note: Parameter guaranteed by design.

## Capacitive Characteristics ( $T_a = 25^\circ\text{C}$ )

Characteristics	Symbol	Test Condition	V <sub>CC</sub> (V)	Typ.	Unit
Input capacitance	C <sub>IN</sub>	—	1.8, 2.5, 3.3	6	pF
Output capacitance	C <sub>O</sub>	—	1.8, 2.5, 3.3	7	pF
Power dissipation capacitance	C <sub>PD</sub>	f <sub>IN</sub> = 10 MHz (Note)	1.8, 2.5, 3.3	20	pF

Note: C<sub>PD</sub> is defined as the value of the internal equivalent capacitance which is calculated from the operating current consumption without load.

Average operating current can be obtained by the equation:

$$I_{CC(\text{opr})} = C_{PD} \cdot V_{CC} \cdot f_{IN} + I_{CC}/20 \text{ (per bit)}$$

**AC Test Circuit**

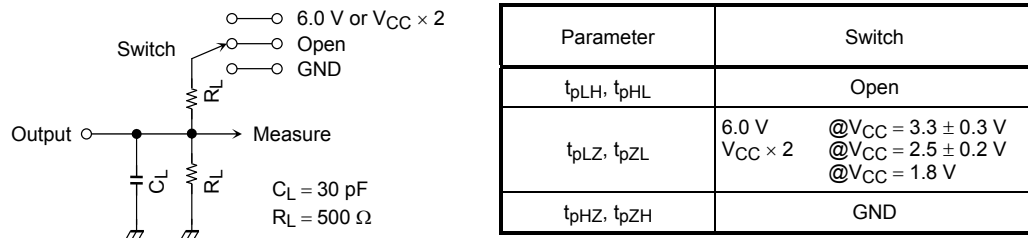

**Figure 1**

**AC Waveform**

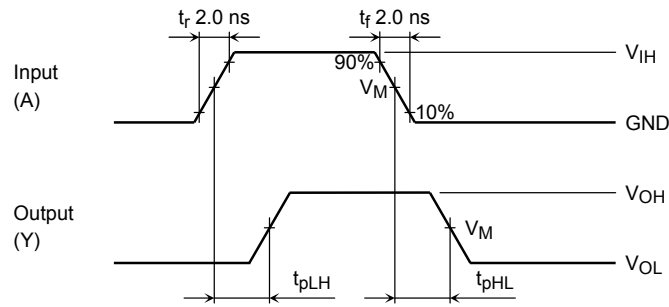

**Figure 2  $t_{pLH}, t_{pHL}$**



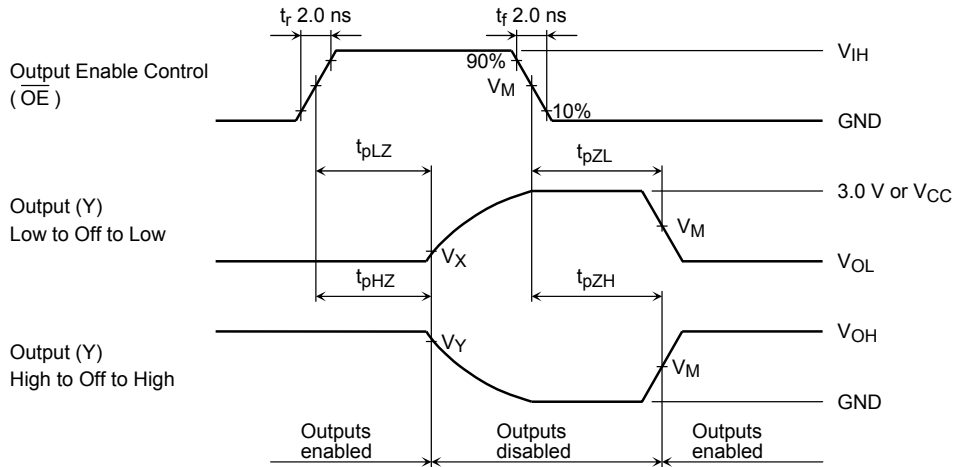

**Figure 3**  $t_{pLZ}$ ,  $t_{pHZ}$ ,  $t_{pZL}$ ,  $t_{pZH}$

Symbol	$V_{CC}$		
	$3.3 \pm 0.3 \text{ V}$	$2.5 \pm 0.2 \text{ V}$	$1.8 \text{ V}$
$V_{IH}$	$2.7 \text{ V}$	$V_{CC}$	$V_{CC}$
$V_M$	$1.5 \text{ V}$	$V_{CC}/2$	$V_{CC}/2$
$V_X$	$V_{OL} + 0.3 \text{ V}$	$V_{OL} + 0.15 \text{ V}$	$V_{OL} + 0.15 \text{ V}$
$V_Y$	$V_{OH} - 0.3 \text{ V}$	$V_{OH} - 0.15 \text{ V}$	$V_{OH} - 0.15 \text{ V}$

## Package Dimensions

TSSOP56-P-0061-0.50A

Unit: mm

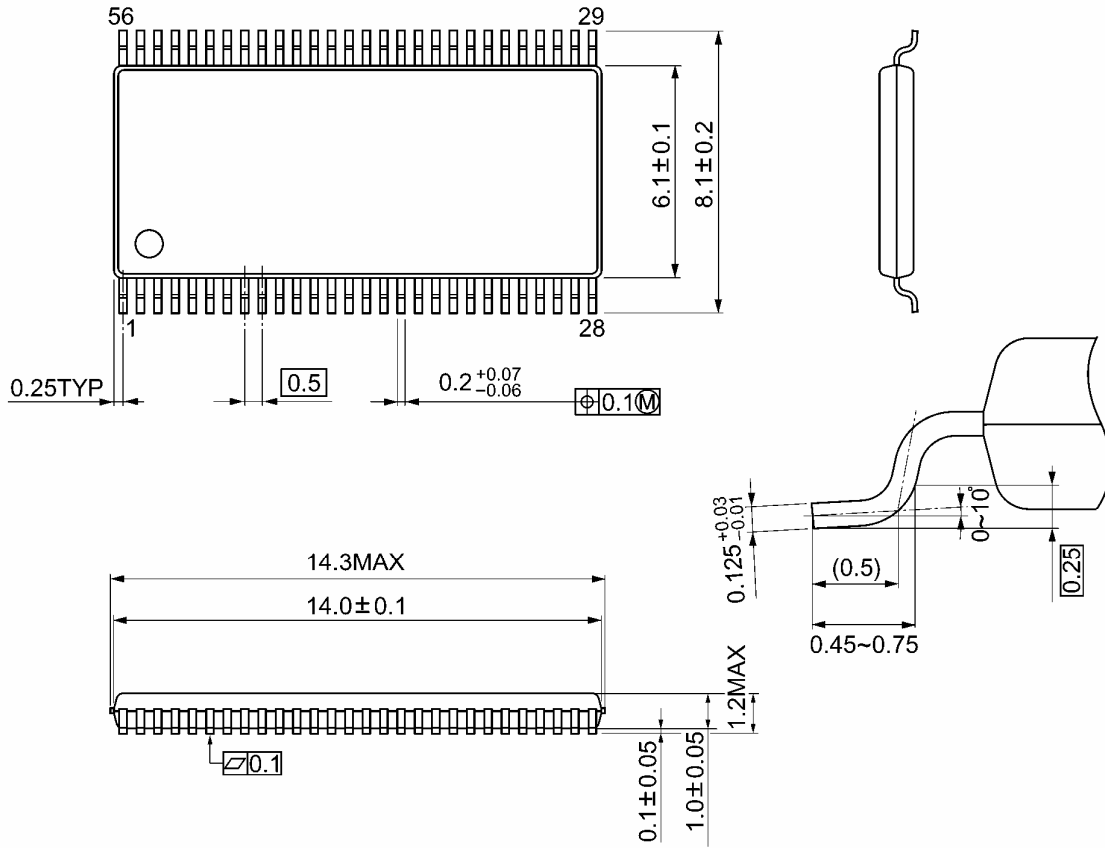

Weight: 0.25 g (typ.)

**RESTRICTIONS ON PRODUCT USE**

20070701-EN GENERAL

- The information contained herein is subject to change without notice.
- TOSHIBA is continually working to improve the quality and reliability of its products. Nevertheless, semiconductor devices in general can malfunction or fail due to their inherent electrical sensitivity and vulnerability to physical stress. It is the responsibility of the buyer, when utilizing TOSHIBA products, to comply with the standards of safety in making a safe design for the entire system, and to avoid situations in which a malfunction or failure of such TOSHIBA products could cause loss of human life, bodily injury or damage to property.  
In developing your designs, please ensure that TOSHIBA products are used within specified operating ranges as set forth in the most recent TOSHIBA products specifications. Also, please keep in mind the precautions and conditions set forth in the "Handling Guide for Semiconductor Devices," or "TOSHIBA Semiconductor Reliability Handbook" etc.
- The TOSHIBA products listed in this document are intended for usage in general electronics applications (computer, personal equipment, office equipment, measuring equipment, industrial robotics, domestic appliances, etc.). These TOSHIBA products are neither intended nor warranted for usage in equipment that requires extraordinarily high quality and/or reliability or a malfunction or failure of which may cause loss of human life or bodily injury ("Unintended Usage"). Unintended Usage include atomic energy control instruments, airplane or spaceship instruments, transportation instruments, traffic signal instruments, combustion control instruments, medical instruments, all types of safety devices, etc.. Unintended Usage of TOSHIBA products listed in this document shall be made at the customer's own risk.
- The products described in this document shall not be used or embedded to any downstream products of which manufacture, use and/or sale are prohibited under any applicable laws and regulations.
- The information contained herein is presented only as a guide for the applications of our products. No responsibility is assumed by TOSHIBA for any infringements of patents or other rights of the third parties which may result from its use. No license is granted by implication or otherwise under any patents or other rights of TOSHIBA or the third parties.
- Please contact your sales representative for product-by-product details in this document regarding RoHS compatibility. Please use these products in this document in compliance with all applicable laws and regulations that regulate the inclusion or use of controlled substances. Toshiba assumes no liability for damage or losses occurring as a result of noncompliance with applicable laws and regulations.