



Single PCI Express, Hot-Plug Controller

MAX5954

General Description

The MAX5954 hot-plug controller is designed for PCI Express™ applications. The device provides hot-plug control for 12V, 3.3V, and 3.3V auxiliary supplies of a single PCI Express (PCI-E) slot. The MAX5954's logic inputs/outputs allow interfacing directly with the system hot-plug management controller or through an SMBus™ with an external I/O expander. Integrated debounced attention switch and present-detect signals are included to simplify system design.

The MAX5954 drives two external n-channel MOSFETs to control the 12V and 3.3V main outputs. The 3.3V auxiliary output is controlled through an internal 0.3Ω n-channel MOSFET. An internal charge pump provides gate drive for the 12V output while the gate drive of the 3.3V output is driven by the 12V input supply. The 3.3V auxiliary output is completely independent from the main outputs with its own charge pump.

At power-up, the MAX5954 keeps all of the external MOSFETs off until the supplies rise above their respective undervoltage-lockout (UVLO) thresholds. The device keeps the internal MOSFET off only until the auxiliary input supply rises above its UVLO threshold. Upon a turn-on command, the MAX5954 enhances the external and internal MOSFETs slowly with a constant gate current to limit the power-supply inrush current. The MAX5954 actively limits the current of all outputs at all times and shuts down if an overcurrent condition persists for longer than a programmable overcurrent timeout. Thermal-protection circuitry also shuts down all outputs if the die temperature exceeds +150°C. After an overcurrent or overtemperature fault condition, the MAX5954L latches off while the MAX5954A automatically restarts after a restart time delay. The device is available in a 36-pin (6mm × 6mm) thin QFN package and operates over the -40°C to +85°C temperature range.

Applications

Servers
Desktop Mobile Server Platforms
Workstations
Embedded Devices

Typical Application Circuit appears at end of data sheet.

SMBus is a trademark of Intel Corp.

PCI Express is a trademark of PCI-SIG Corp.



Maxim Integrated Products 1

For pricing, delivery, and ordering information, please contact Maxim/Dallas Direct! at 1-888-629-4642, or visit Maxim's website at www.maxim-ic.com.

Features

- ◆ PCI Express Compliant
- ◆ Hot Swaps 12V, 3.3V, and 3.3V Auxiliary for a Single PCI-E Slot
- ◆ Integrated Power MOSFET for Auxiliary Supply Rail
- ◆ Controls di/dt and dv/dt
- ◆ Active Current Limiting Protects Against Overcurrent/Short-Circuit Conditions
- ◆ Programmable Current-Limit Timeout
- ◆ PWRGD Signal Output with Programmable Power-On Reset (POR) (160ms Default)
- ◆ Latched FAULT Signal Output after Overcurrent or Overtemperature Fault
- ◆ Attention Switch Input/Output with 4.4ms Debounce
- ◆ Present-Detect Input
- ◆ Forced-On Input Facilitates Testing
- ◆ Thermal Shutdown
- ◆ Allows Control through SMBus with an I/O Expander

Ordering Information

PART	TEMP RANGE	PIN-PACKAGE	PKG CODE
MAX5954AETX+	-40°C to +85°C	36 Thin QFN	T3666-3
MAX5954LETX+	-40°C to +85°C	36 Thin QFN	T3666-3

+Denotes lead free package.

Pin Configuration

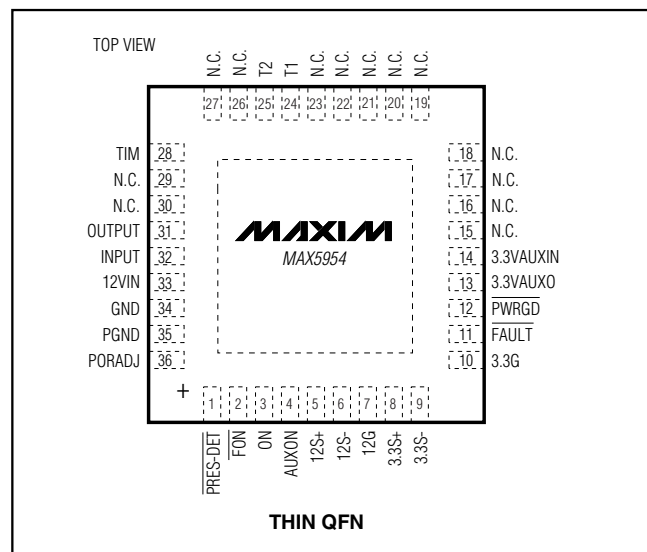

Single PCI Express, Hot-Plug Controller

ABSOLUTE MAXIMUM RATINGS

(All voltages referenced to GND, unless otherwise noted.)

12VIN	-0.3V to +14V
12G	-0.3V to (V _{12VIN} + 6V)
12S, 12S-, 3.3G	-0.3V to (V _{12VIN} + 0.3V)
3.3VAUXIN, ON, FAULT	-0.3V to +6V
PWRGD	-0.3V to +6V
PGND	-0.3V to +0.3V
All Other Pins to GND	-0.3V to (V _{3.3VAUXIN} + 0.3V)

Continuous Power Dissipation (T_A = +70°C)

36-Pin Thin QFN (derate 26.3mW/°C above +70°C)	2.105W
Operating Temperature Range	-40°C to +85°C
Junction Temperature	+150°C
Storage Temperature Range	-65°C to +150°C
Lead Temperature (soldering, 10s)	+300°C

Stresses beyond those listed under "Absolute Maximum Ratings" may cause permanent damage to the device. These are stress ratings only, and functional operation of the device at these or any other conditions beyond those indicated in the operational sections of the specifications is not implied. Exposure to absolute maximum rating conditions for extended periods may affect device reliability.

ELECTRICAL CHARACTERISTICS

(V_{12VIN} = V_{12S-} = V_{12S+} = 12V, V_{3.3S+} = V_{3.3S-} = V_{3.3VAUXIN} = V_{ON} = V_{AUXON} = V_{FON} = 3.3V, PWRGD = FAULT = PORADJ = TIM = OUTPUT = 12G = 3.3G = OPEN, INPUT = PRES-DET = PGND = GND, T_A = -40°C to +85°C, unless otherwise noted. Typical values are at T_A = +25°C.) (Note 1)

PARAMETER	SYMBOL	CONDITIONS	MIN	TYP	MAX	UNITS
12V SUPPLY						
12V Supply Voltage Range	V _{12VIN}		10.8	12	13.2	V
12VIN Undervoltage Lockout	V _{12UVLO}	V _{12VIN} rising	9.5	10	10.5	V
		Hysteresis		0.1		
12VIN Supply Current	I _{12VIN}	V _{12VIN} = 13.2V		0.5	1	mA
12VIN CONTROL						
12VIN Current-Limit Threshold (V _{12S+} - V _{12S-})	V _{12ILIM}		49	54	59	mV
12G Gate Charge Current	I _{12G_CHG}	V _{12G} = GND	4	5	6	μA
12G Gate Discharge Current	I _{12G_DIS}	Normal turn-off, ON = GND, V _{12G} = 2V	50	150	250	μA
		Output short-circuit condition, strong gate pulldown to regulation, V _{12VIN} - V _{12S-} ≥ 1V, V _{12G-} = 5V	50	120	180	mA
12G Gate High Voltage (V _{12G} - V _{12VIN})	V _{12GH}	I _{12G} = 1μA	4.8	5.3	5.8	V
12G Threshold Voltage For PWRGD Assertion	V _{PGTH12}	Referred to V _{12VIN} , I _{12G-} = 1μA (Note 2)	3.0	4	4.8	V
12S- Input Bias Current					1	μA
12S+ Input Bias Current				20	60	μA
3.3V SUPPLY						
3.3V Supply Voltage Range	V _{3.3S+}		3.0	3.3	3.6	V
Undervoltage Lockout (Note 3)		3.3S+ rising	2.52	2.65	2.78	V
		Hysteresis		30		mV

Single PCI Express, Hot-Plug Controller

MAX5954

ELECTRICAL CHARACTERISTICS (continued)

($V_{12VIN} = V_{12S-} = V_{12S+} = 12V$, $V_{3.3S+} = V_{3.3S-} = V_{3.3VAUXIN} = V_{ON} = V_{AUXON} = V_{FON} = 3.3V$, $\overline{PWRGD} = \overline{FAULT} = \overline{PORADJ} = \overline{TIM} = \overline{OUTPUT} = 12G = 3.3G = \text{OPEN}$, $\text{INPUT} = \overline{\text{PRES-DET}} = \text{PGND} = \text{GND}$, $T_A = -40^\circ\text{C}$ to $+85^\circ\text{C}$, unless otherwise noted. Typical values are at $T_A = +25^\circ\text{C}$.) (Note 1)

PARAMETER	SYMBOL	CONDITIONS	MIN	TYP	MAX	UNITS
3.3V CONTROL						
3.3V Current-Limit Threshold ($V_{3.3S+} - V_{3.3S-}$)	$V_{3.3LIM}$		17	20	23	mV
3.3G Gate Charge Current	$I_{3.3G\ CHG}$	$V_{3.3G} = \text{GND}$	4	5	6	μA
3.3G Gate Discharge Current	$I_{3.3G\ DIS}$	$\text{ON} = \text{GND}$, $V_{3.3G} = 2V$	50	150	250	μA
		Output short-circuit condition, strong gate pulldown to regulation, $V_{3.3S+} - V_{3.3S-} \geq 1V$, $V_{3.3G} = 5V$	100	150	220	mA
3.3G Gate High Voltage ($V_{3.3G} - V_{3.3S+}$)	$V_{3.3G_H}$	Sourcing $1\mu\text{A}$	4.5	5.5	6.8	V
3.3G Threshold Voltage For $\overline{\text{PWRGD}}$ Assertion	$V_{PGTH3.3}$	Referred to $V_{3.3VAUXIN}$, $I_{3.3G} = 1\mu\text{A}$ (Note 2)	-3.0	+4	+4.5	V
3.3S- Input Bias Current					1	μA
3.3S+ Input Bias Current				20	60	μA
3.3V AUXILIARY SUPPLY						
3.3VAUXIN Supply Voltage Range	$V_{3.3VAUXIN}$		3.0	3.3	3.6	V
3.3VAUXIN Undervoltage Lockout	$V_{3.3VAUXUVLO}$	3.3VAUXIN rising	2.52	2.65	2.78	V
		Hysteresis		30		mV
3.3VAUXIN Supply Current		$V_{3.3VAUXIN} = 3.6V$		1.5	3	mA
3.3VAUXIN to 3.3VAUXO Maximum Dropout		$I_{3.3VAUXO} = 375\text{mA}$			225	mV
3.3VAUXO Current-Limit Threshold		3.3VAUXO shorted to GND	376	470	564	mA
3.3VAUXO Threshold For $\overline{\text{PWRGD}}$ Assertion ($V_{3.3VAUXIN} - V_{3.3VAUXO}$)	$V_{PGTH3.3AUX}$	(Note 3)			400	mV
LOGIC SIGNALS						
Input-Logic Threshold (ON , $\overline{\text{FON}}$, AUXON , $\overline{\text{PRES-DET}}$, INPUT)		Rising edge	1.0		2.0	V
		Hysteresis		25		mV
Input Bias Current (ON , AUXON , INPUT)					1	μA
$\overline{\text{FON}}$, $\overline{\text{PRES-DET}}$ Internal Pullup			25	50	75	$k\Omega$
ON , AUXON High-to-Low Deglitch Time				4		μs

Single PCI Express, Hot-Plug Controller

ELECTRICAL CHARACTERISTICS (continued)

($V_{12VIN} = V_{12S-} = V_{12S+} = 12V$, $V_{3.3S+} = V_{3.3S-} = V_{3.3VAUXIN} = V_{ON} = V_{AUXON} = V_{FON} = 3.3V$, $\overline{PWRGD} = \overline{FAULT} = \overline{PORADJ} = \overline{TIM} = \overline{OUTPUT} = 12G = 3.3G = \text{OPEN}$, $\text{INPUT} = \overline{\text{PRES-DET}} = \text{PGND} = \text{GND}$, $T_A = -40^\circ\text{C}$ to $+85^\circ\text{C}$, unless otherwise noted. Typical values are at $T_A = +25^\circ\text{C}$.) (Note 1)

PARAMETER	SYMBOL	CONDITIONS	MIN	TYP	MAX	UNITS
PRES-DET High-to-Low Deglitch Time	t _{DEG}		3	5	7	ms
\overline{PWRGD} Power-On Reset Time (Note 2)	t _{POR_HL}	PORADJ = open	90	160	250	ms
		R _{PORADJ} = 20k Ω	35	55	75	
		R _{PORADJ} = 100k Ω	145	265	380	
		R _{PORADJ} = 200k Ω		570		
\overline{PWRGD} Low-to-High Deglitch Time	t _{POR_LH}		4		μs	
\overline{PWRGD} , \overline{FAULT} Output Low Voltage		Sinking 2mA			0.1	V
		Sinking 30mA			0.7	
\overline{PWRGD} , \overline{FAULT} Output-High Leakage Current		$V_{\overline{PWRGD}} = V_{\overline{FAULT}} = 5.5V$			1	μA
\overline{FAULT} Timeout	t _{FAULT}	TIM = open	5.5	11	17.0	ms
		R _{TIM} = 15k Ω	1.4	2.6	3.8	
		R _{TIM} = 120k Ω	12	22	32	
		R _{TIM} = 300k Ω		59		
\overline{FAULT} Timeout During Startup	t _{SU}		2 x t _{FAULT}			ms
Autorestart Delay Time	t _{RESTART}		64 x t _{FAULT}			ms
Fault Reset Minimum Pulse Width	t _{RESET}	(Note 4)		100		μs
Thermal-Shutdown Threshold	T _{SD}	T _J rising		+150		$^\circ\text{C}$
Thermal-Shutdown Threshold Hysteresis				20		$^\circ\text{C}$
OUTPUT Debounce Time	t _{DBC}		2.6	4.4	6.2	ms
OUTPUT High Voltage		Sourcing 2mA	$V_{3.3VAUXIN} - 0.3$	$V_{3.3VAUXIN}$		V
OUTPUT Low Voltage		Sinking 2mA			0.4	V

Note 1: 100% production tested at $T_A = +25^\circ\text{C}$. Parameters over temperature are guaranteed by design.

Note 2: \overline{PWRGD} asserts a time t_{POR_HL} after V_{PGTH12}, V_{PGTH3.3}, and V_{PGTH3.3AUX} conditions are met.

Note 3: The UVLO for the 3.3V supply is sensed at 3.3S+.

Note 4: This is the time that ON or AUXON must stay low when resetting a fault condition.

Single PCI Express, Hot-Plug Controller

Typical Operating Characteristics

($V_{12VIN} = V_{12S+} = 12V$, $V_{3.3VAUXIN} = V_{3.3S+} = V_{ON} = V_{AUXON} = V_{INPUT} = 3.3V$, $PRES-DET = GND$, $FON = PORADJ = TIM = float$, $FAULT = 10k\Omega$ to $3.3VAUXIN$, $PWRGD = 10k\Omega$ to $3.3VAUXO$, $T_A = +25^\circ C$, unless otherwise noted, see the *Typical Application Circuit*.)

MAX5954

12VIN INPUT SUPPLY CURRENT vs. TEMPERATURE

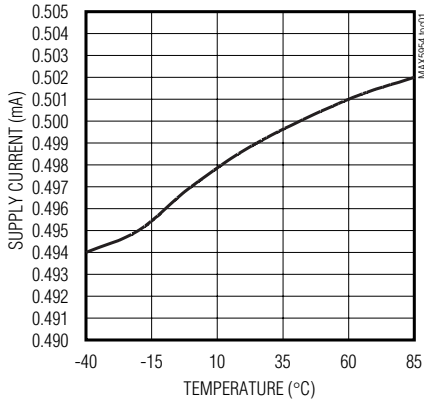

3.3VAUXIN SUPPLY CURRENT vs. TEMPERATURE

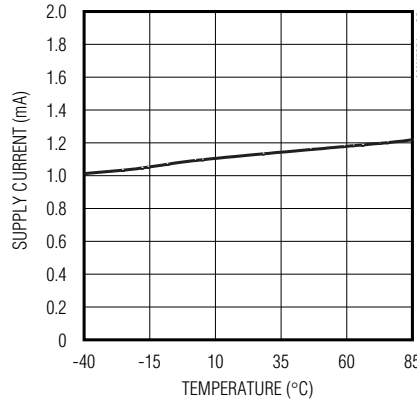

ON AND AUXON LOW-TO-HIGH THRESHOLD VOLTAGE vs. TEMPERATURE

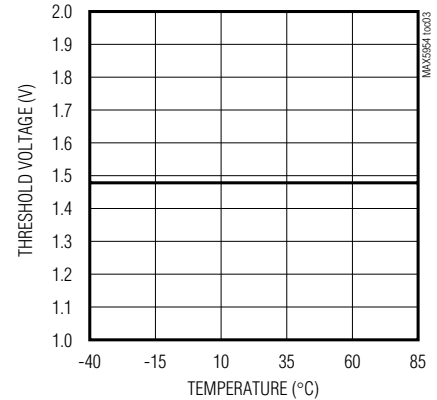

3.3VAUXO OUTPUT VOLTAGE vs. CURRENT

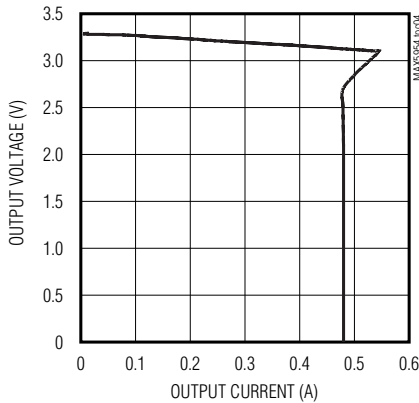

12G AND 3.3G GATE CHARGE CURRENT vs. TEMPERATURE

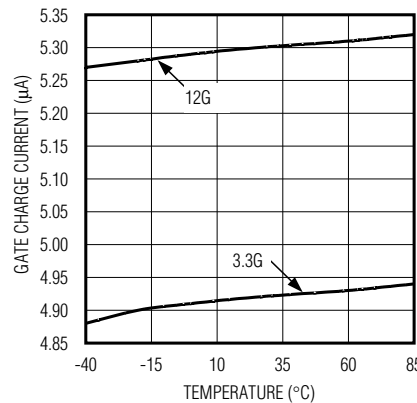

12G AND 3.3G GATE DISCHARGE CURRENT vs. TEMPERATURE

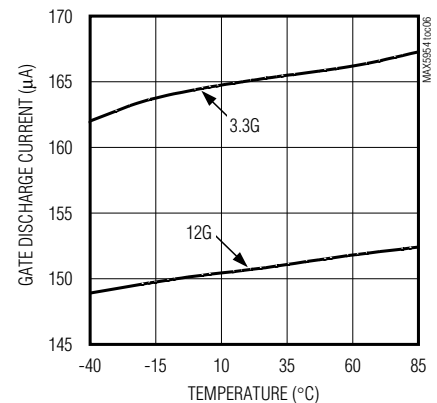

3.3VAUX INTERNAL SWITCH MAXIMUM DROPOUT vs. TEMPERATURE

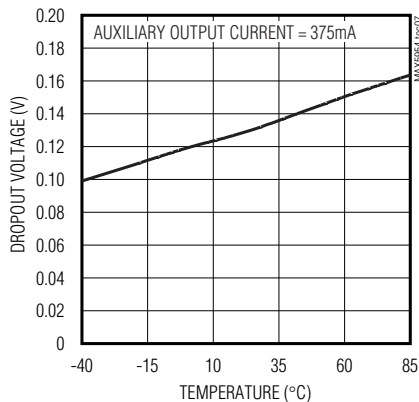

12V AND 3.3V CURRENT-LIMIT THRESHOLD VOLTAGE vs. TEMPERATURE

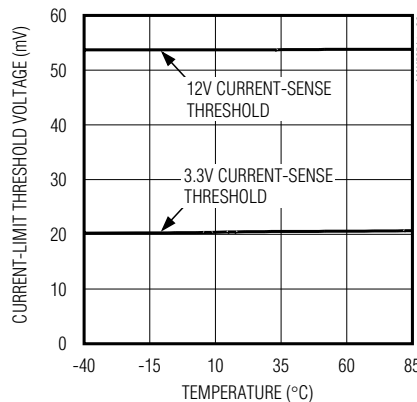

AUXILIARY CURRENT LIMIT vs. TEMPERATURE

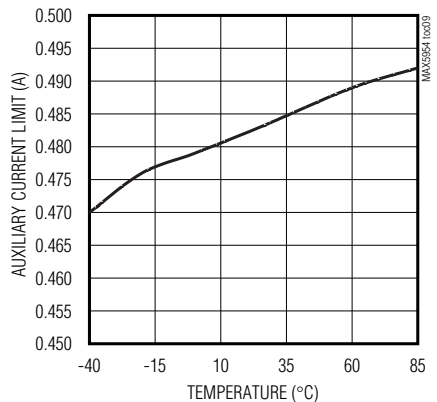

Single PCI Express, Hot-Plug Controller

Typical Operating Characteristics (continued)

($V_{12VIN} = V_{12S+} = 12V$, $V_{3.3VAUXIN} = V_{3.3S+} = V_{ON} = V_{AUXON} = V_{INPUT} = 3.3V$, $\overline{PRES-DET} = GND$, $FON = PORADJ = TIM = float$, $\overline{FAULT} = 10k\Omega$ to $3.3VAUXIN$, $\overline{PWRGD} = 10k\Omega$ to $3.3VAUXO$, $T_A = +25^\circ C$, unless otherwise noted, see the *Typical Application Circuit*.)

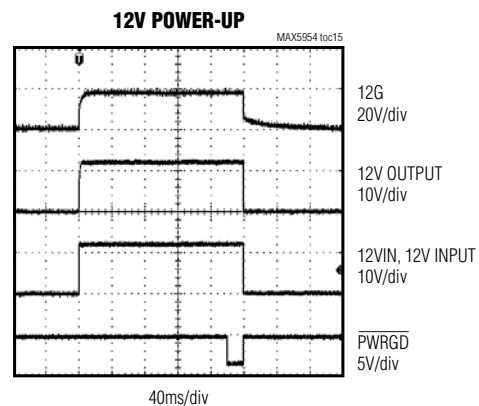
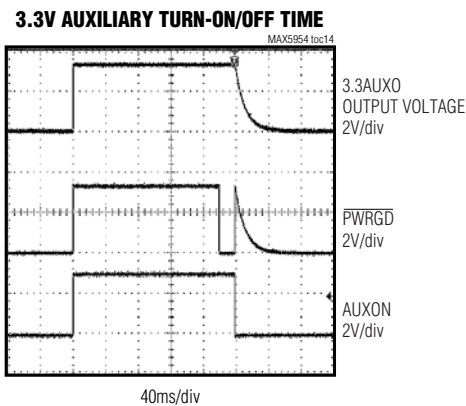
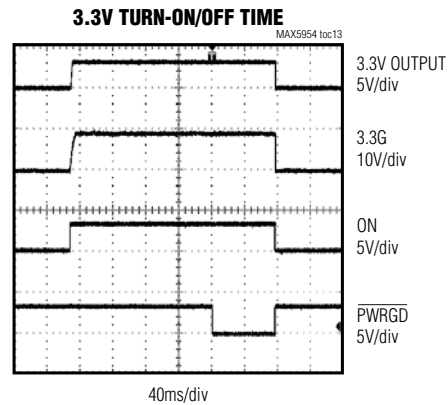
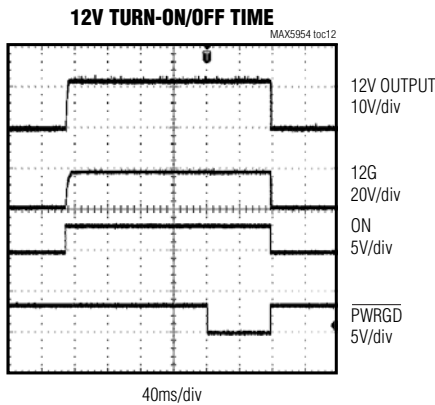
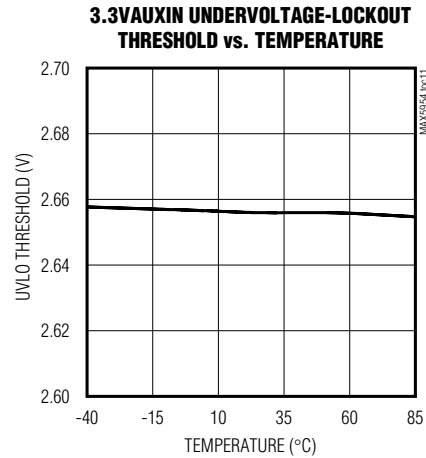
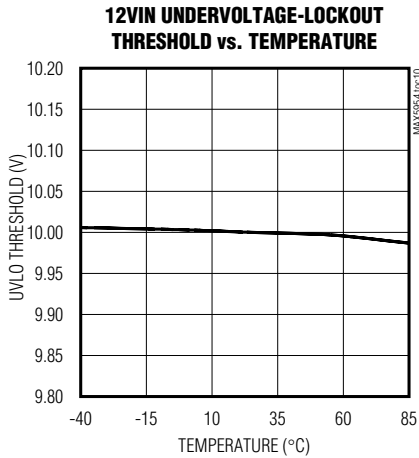

Single PCI Express, Hot-Plug Controller

MAX5954

Typical Operating Characteristics (continued)

($V_{12VIN} = V_{12S+} = 12V$, $V_{3.3VAUXIN} = V_{3.3S+} = V_{ON} = V_{AUXON} = V_{INPUT} = 3.3V$, $PRES-DET = GND$, $FON = PORADJ = TIM = float$, $FAULT = 10k\Omega$ to $3.3VAUXIN$, $PWRGD = 10k\Omega$ to $3.3VAUXO$, $T_A = +25^\circ C$, unless otherwise noted, see the *Typical Application Circuit*.)

3.3V INPUT/3.3V AUXILIARY INPUT POWER-UP

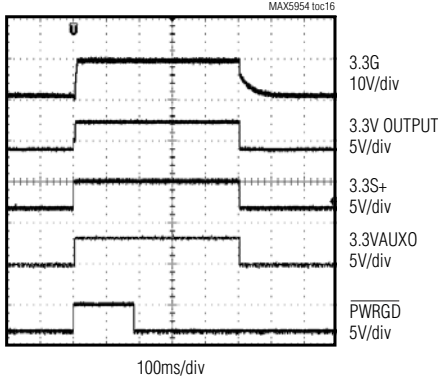

TURN-ON DELAY 3.3V OUTPUT AND 3.3V AUXILIARY OUTPUT

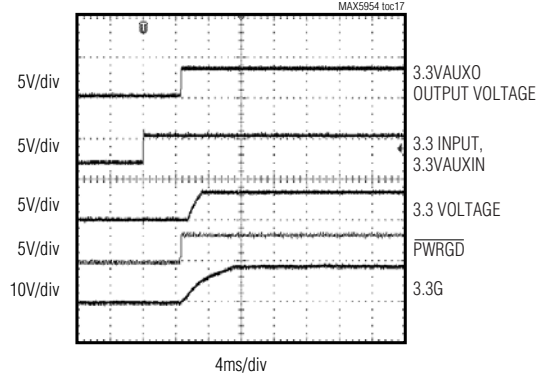

FAULT CONDITION ON 12V OUTPUT (AUTORESTART OPTION MAX5954A)

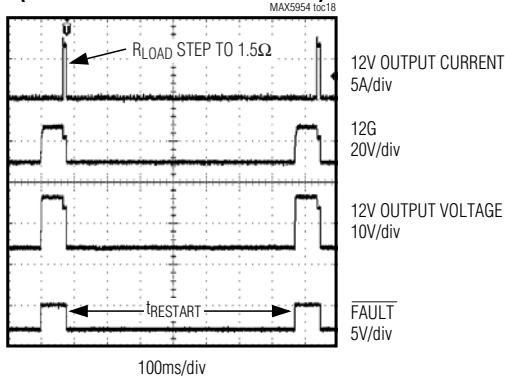

FAULT CONDITION ON 3.3V OUTPUT (AUTORESTART OPTION MAX5954A)

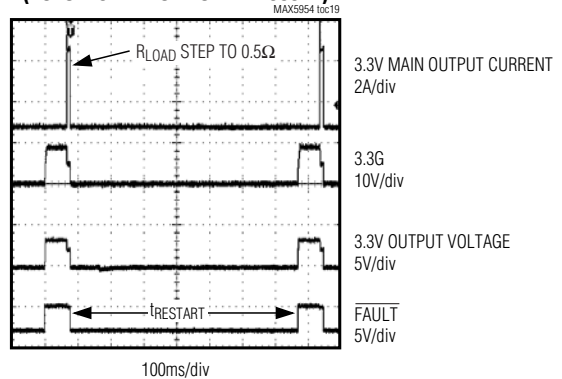

FAULT CONDITION ON AUXILIARY OUTPUT (AUTORESTART OPTION MAX5954A)

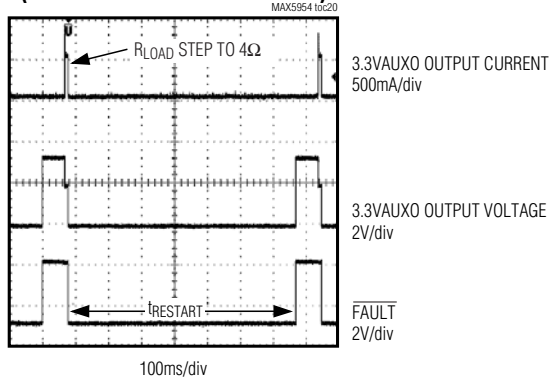

FAULT CONDITION ON 12V OUTPUT (LATCH OPTION MAX5954L)

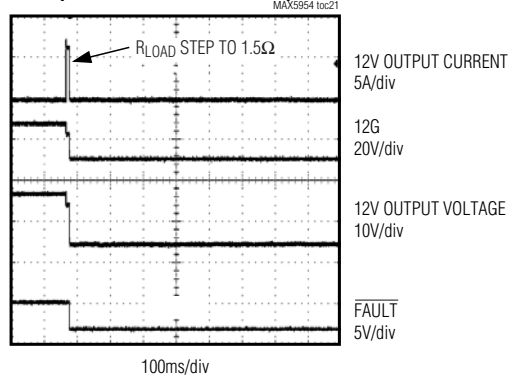

Single PCI Express, Hot-Plug Controller

Typical Operating Characteristics (continued)

($V_{12VIN} = V_{12S+} = 12V$, $V_{3.3VAUXIN} = V_{3.3S+} = V_{ON} = V_{AUXON} = V_{INPUT} = 3.3V$, $PRES-DET = GND$, $FON = PORADJ = TIM = float$, $FAULT = 10k\Omega$ to $3.3VAUXIN$, $PWRGD = 10k\Omega$ to $3.3VAUXO$, $T_A = +25^\circ C$, unless otherwise noted, see the *Typical Application Circuit*.)

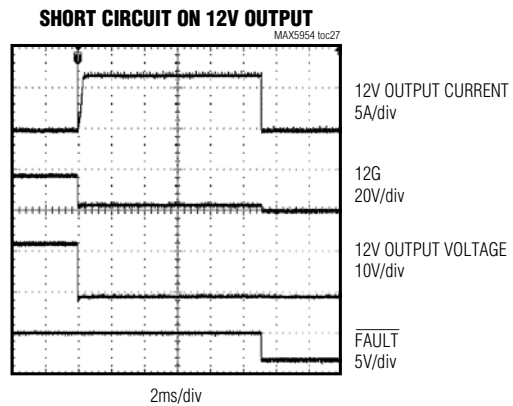
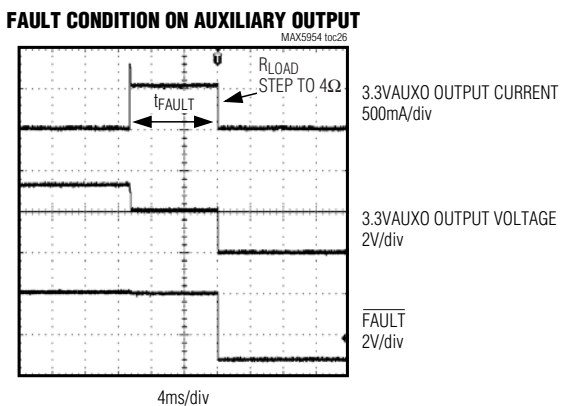
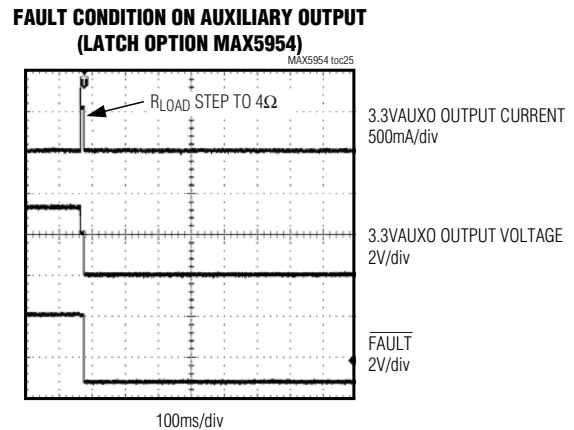
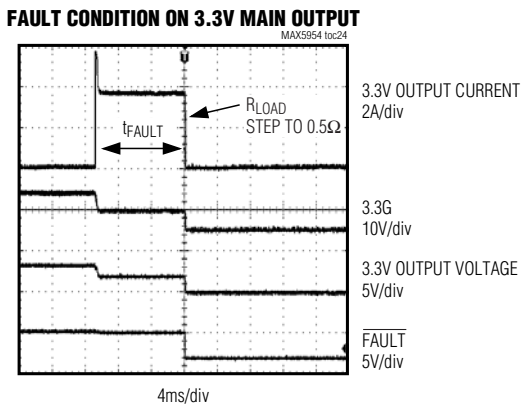
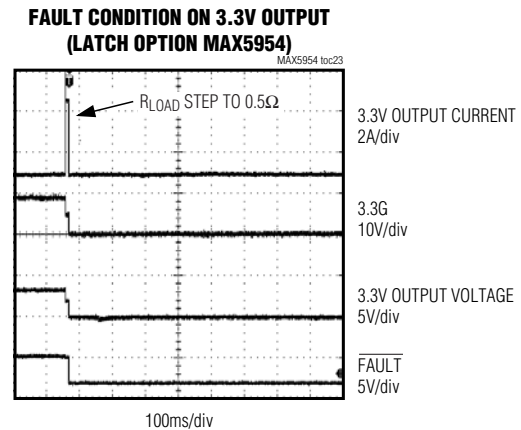
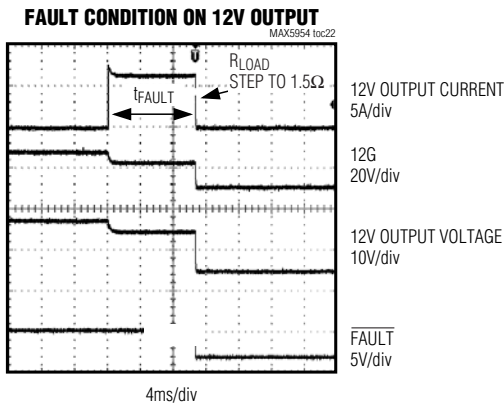

Single PCI Express, Hot-Plug Controller

MAX5954

Typical Operating Characteristics (continued)

($V_{12VIN} = V_{12S+} = 12V$, $V_{3.3VAUXIN} = V_{3.3S+} = V_{ON} = V_{AUXON} = V_{INPUT} = 3.3V$, $\overline{PRES-DET} = GND$, $FON = PORADJ = TIM = \text{float}$, $\overline{FAULT} = 10k\Omega$ to $3.3VAUXIN$, $\overline{PWRGDA} = 10k\Omega$ to $3.3VAUXO$, $T_A = +25^\circ C$, unless otherwise noted, see the *Typical Application Circuit*.)

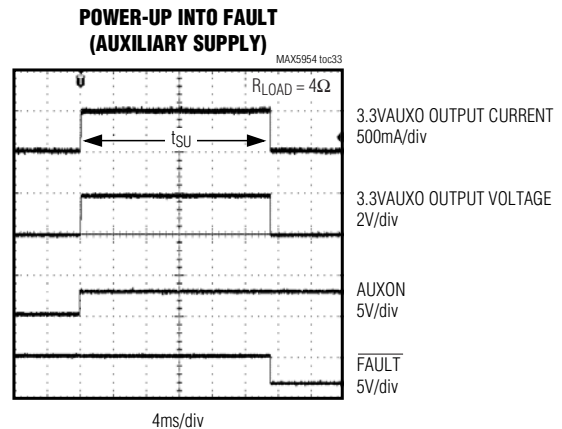
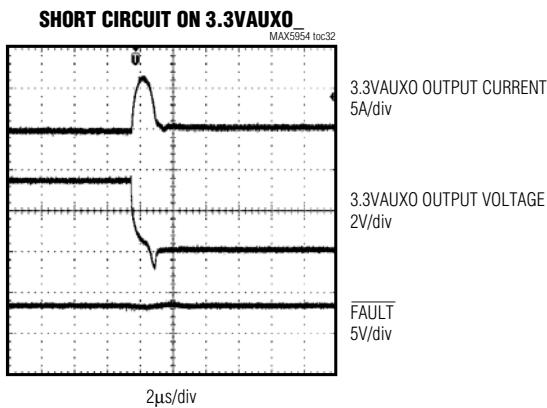
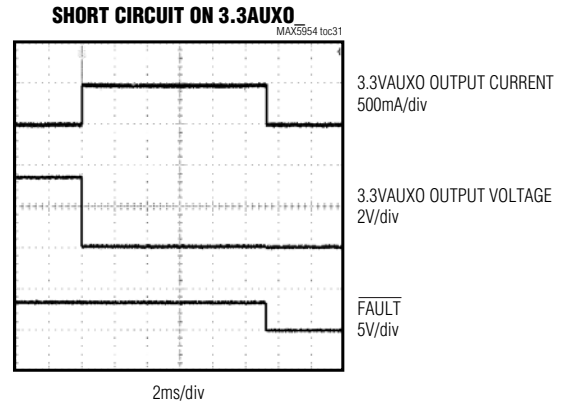
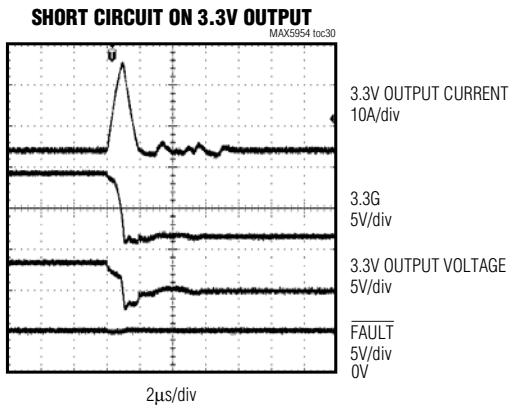
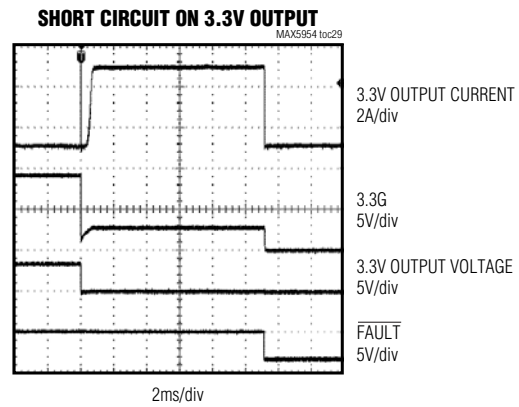
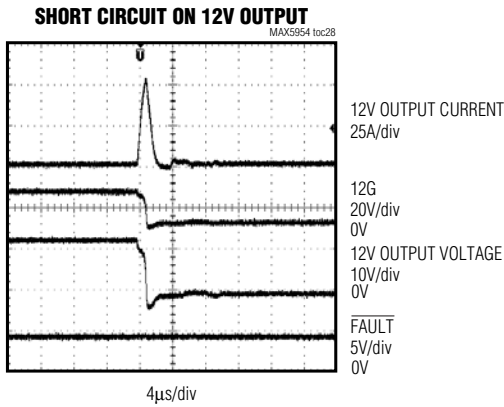

Single PCI Express, Hot-Plug Controller

Typical Operating Characteristics (continued)

($V_{12VIN} = V_{12S+} = 12V$, $V_{3.3VAUXIN} = V_{3.3S+} = V_{ON} = V_{AUXON} = V_{INPUT} = 3.3V$, $PRES-DET = GND$, $FON = PORADJ = TIM = float$, $FAULT = 10k\Omega$ to $3.3VAUXIN$, $PWRGD\bar{A} = 10k\Omega$ to $3.3VAUXO$, $T_A = +25^\circ C$, unless otherwise noted, see the *Typical Application Circuit*.)

POWER-UP INTO FAULT (3.3V MAIN)

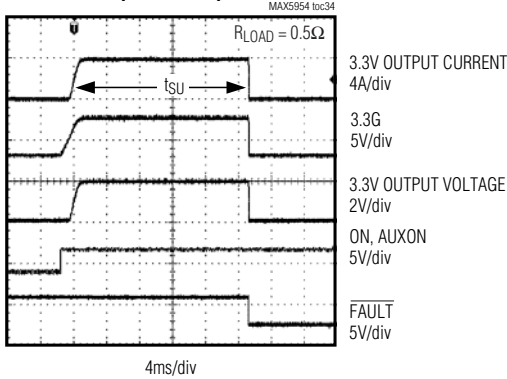

POWER-UP INTO FAULT (12V OUTPUT)

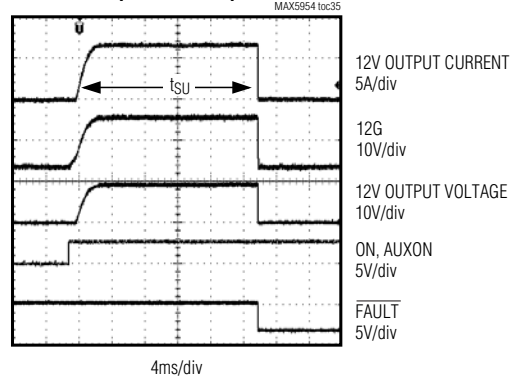

PRESENT-DETECT (ON/OFF) OPERATION

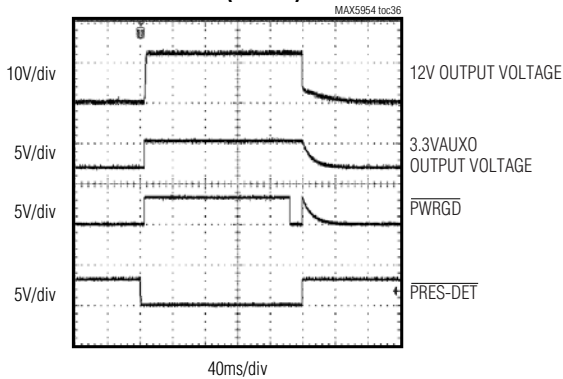

PRESENT-DETECT (ON/OFF) OPERATION

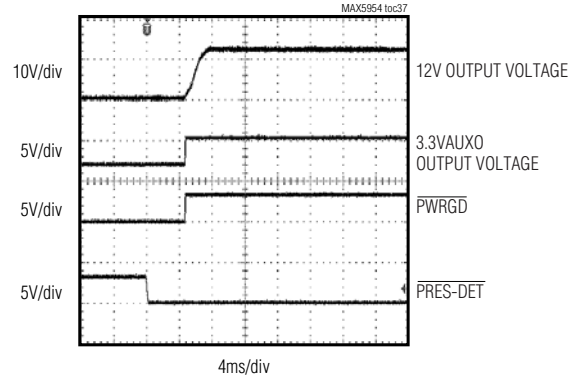

FORCED-ON (ON/OFF) OPERATION

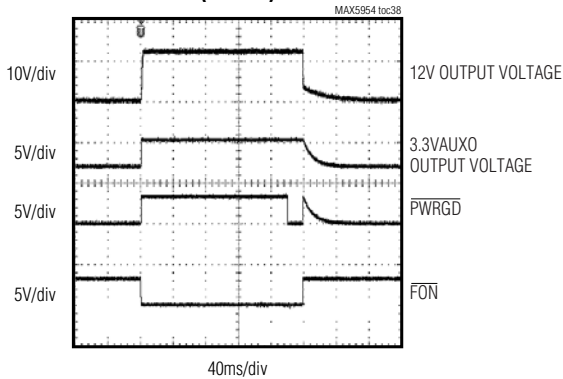

FORCED-ON (ON/OFF) OPERATION

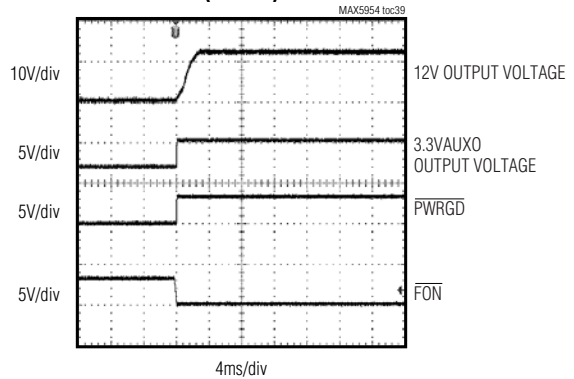

Single PCI Express, Hot-Plug Controller

MAX5954

Typical Operating Characteristics (continued)

($V_{12VIN} = V_{12S+} = 12V$, $V_{3.3VAUXIN} = V_{3.3S+} = V_{ON} = V_{AUXON} = V_{INPUT} = 3.3V$, $\overline{PRES-DET} = GND$, $FON = PORADJ = TIM = \text{float}$, $FAULT = 10k\Omega$ to $3.3VAUXIN$, $PWRGDA = 10k\Omega$ to $3.3VAUXO$, $T_A = +25^\circ C$, unless otherwise noted, see the *Typical Application Circuit*.)

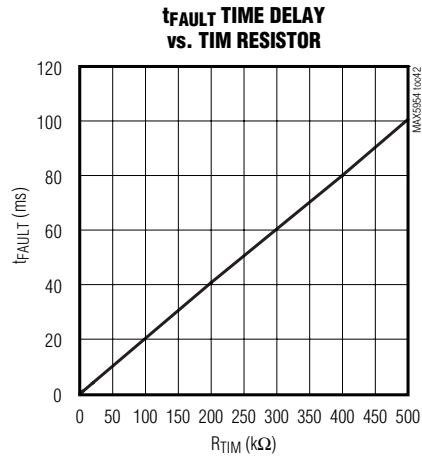
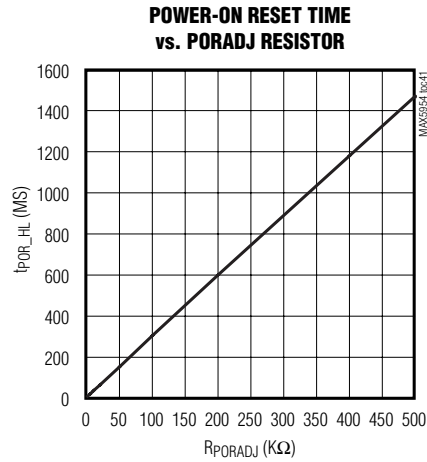
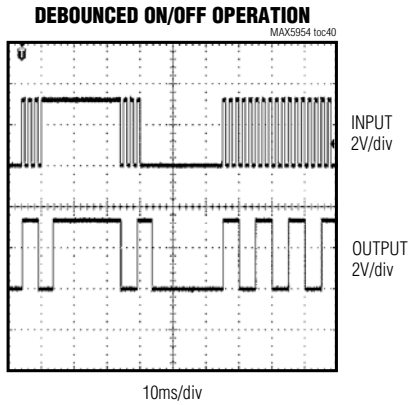

Single PCI Express, Hot-Plug Controller

Pin Description

PIN	NAME	FUNCTION
1	$\overline{\text{PRES-DET}}$	Present-Detect Input. $\overline{\text{PRES-DET}}$ accepts inputs from the PRSNT#2 pin on a PCI-E connector. $\overline{\text{PRES-DET}}$ has an internal pullup to 3.3VAUXIN. When $\overline{\text{PRES-DET}}$ is low, the outputs follow the command from ON and AUXON after a 4ms debounced time. When $\overline{\text{PRES-DET}}$ goes from low to high, all outputs of the respective slot shut down with no delay (see Table 2).
2	$\overline{\text{FON}}$	Forced-On Input. $\overline{\text{FON}}$ has a 50k Ω internal pullup to 3.3VAUXIN. A logic-low on $\overline{\text{FON}}$ turns on all PCI-E outputs as long as the power inputs are within their operating range, regardless of the status of the other input signals. Leave $\overline{\text{FON}}$ open for normal operation (see Table 2).
3	ON	12V and 3.3V Outputs Enable. A logic-high at ON turns on the 12V and 3.3V outputs (see Table 2).
4	AUXON	3.3V Auxiliary Output Enable. A logic-high at AUXON turns on the auxiliary output (3.3VAUXO) (see Table 2).
5	12S+	12V Positive Current-Sense Input. Connect the positive terminal of the current-sense resistor to 12S+ using the Kelvin-sensing technique to assure accurate current sensing.
6	12S-	12V Negative Current-Sense Input. Connect 12S- to the negative side of the current-sense resistor using the Kelvin-sensing technique to assure accurate current sensing.
7	12G	12V Gate-Drive Output. Connect 12G to the gate of the 12V MOSFET. At power-up, V _{12G} is raised to the internal charge-pump voltage level by a constant current.
8	3.3S+	3.3V Positive Current-Sense Input. Connect the positive side of the current-sense resistor to 3.3S+ using the Kelvin-sensing technique to assure accurate current sensing. This input is also used for the 3.3V supply's UVLO function.
9	3.3S-	3.3V Negative Current-Sense Input. Connect to the negative side of the sense resistor using the Kelvin-sensing technique to assure accurate current sensing.
10	3.3G	3.3V Gate-Drive Output. Connect 3.3G to the gate of the 3.3V MOSFET. At power-up, V _{3.3G} is charged to 5.5V above the 3.3V supply by a constant current derived from V _{12VIN} .
11	$\overline{\text{FAULT}}$	Open-Drain Fault Output Signal. $\overline{\text{FAULT}}$ latches active low whenever the outputs are shut down due to a fault. A fault is either of: <ul style="list-style-type: none"> • An overcurrent condition lasting longer than the overcurrent timeout. • A device over temperature condition. If the fault is detected in the main outputs, $\overline{\text{FAULT}}$ must be reset by toggling the ON input. If the fault is in the auxiliary output, $\overline{\text{FAULT}}$ must be reset by toggling both ON and AUXON. For the auto-restart version, $\overline{\text{FAULT}}$ is reset when the part initiates the next power-on cycle.
12	$\overline{\text{PWRGD}}$	Open-Drain Power-Good Output. $\overline{\text{PWRGD}}$ goes low t _{POR_HL} after all outputs reach their final value and the power MOSFETs are fully enhanced.
13	3.3VAUXO	3.3V Auxiliary Power-Supply Output
14	3.3VAUXIN	3.3V Auxiliary Supply Input. 3.3VAUXIN is the input to a charge pump that drives the internal MOSFET connecting 3.3VAUXIN to 3.3VAUXO. V _{3.3VAUXIN} is also used to power the internal control logic and analog references of the MAX5954.
15–23, 26, 27, 29, 30	N.C.	No Connection. Not internally connected.
24	T1	Test Input. Connect T1 to GND.

Single PCI Express, Hot-Plug Controller

MAX5954

Pin Description (continued)

PIN	NAME	FUNCTION
25	T2	Test Input. Connect T2 to GND.
28	TIM	Overcurrent Timeout Programming Input. Connect a resistor between 500Ω and 500kΩ from TIM to GND to program t _{FAULT} . Leave TIM floating for a default timeout of 11ms.
31	OUTPUT	Digital Output. 4ms debounced digital output of INPUT.
32	INPUT	Digital Logic Gate Input
33	12VIN	12V Supply Input. V _{12VIN} drives the gate of the MOSFET connected to 3.3G. 12VIN powers an internal charge pump that drives the gate of the MOSFET connected to 12G.
34	GND	Ground
35	PGND	Power Ground. Connect externally to GND.
36	PORADJ	Power-On-Reset Programming Input. Connect a resistor between 500Ω and 500kΩ from PORADJ to GND to program the POR timing. Leave floating for a default value of 160ms.

Detailed Description

The MAX5954 hot-plug controller is designed for PCI Express applications. The device provides hot-plug control for 12V, 3.3V, and 3.3V auxiliary supplies of a single PCI Express slot. The MAX5954's logic inputs/outputs allow interfacing directly with the system hot-plug-management controller or through an SMBus with an external I/O expander. An integrated debounced attention switch and present-detect signals are included to simplify system design.

The MAX5954 drives two external n-channel MOSFETs to control the 12V and 3.3V main outputs. The 3.3V auxiliary output is controlled through an internal 0.3Ω n-channel MOSFET. An internal charge pumps provides a gate drive for the 12V output while the gate drive of the 3.3V output is driven by the 12V input supply. The 3.3V auxiliary output is completely independent from the main outputs with its own charge pump.

At power-up, the MAX5954 keeps all of the external MOSFETs off until all supplies rise above their respective UVLO thresholds. The device keeps the internal MOSFET off only until the 3.3VAUXIN supply rises above its UVLO threshold. Upon a turn-on command, the MAX5954 enhances the external and internal MOSFETs slowly with a constant gate current to limit the power-supply inrush current. The MAX5954 actively limits the current of all outputs at all times and shuts down if an overcurrent condition persists for longer than a programmable overcurrent timeout. Thermal-protection circuitry also shuts down all outputs if the die temperature exceeds +150°C. After an overcurrent or overtemperature fault condition, the MAX5954L latches

off while the MAX5954A automatically restarts after a restart time delay.

The power requirement for PCI Express connectors is defined by the PCI Express card specification and summarized in Table 1.

Startup

The main supply outputs can become active only after all the following events have occurred:

- V_{3.3VAUXIN} is above its UVLO threshold
- V_{12VIN} and V_{3.3S+} are both above their UVLO threshold
- ON is driven high
- $\overline{\text{PRES-DET}}$ is low for more than 5ms

The auxiliary supply output is made available only after the following events have occurred:

- V_{3.3VAUXIN} is above its UVLO threshold
- AUXON is driven high
- $\overline{\text{PRES-DET}}$ is low for more than 5ms

The $\overline{\text{FON}}$ input overrides all other control signals and turns on the PCI Express slot when driven low, as long as the UVLO thresholds have been reached. Table 2 summarizes the logic conditions required for startup.

The auxiliary supply input powers the internal control logic and analog references of the MAX5954, so the main supplies cannot be enabled if V_{3.3VAUXIN} is not present.

When an output is enabled, a programmable startup timer (t_{SU}) begins to count the startup time duration. The value of t_{SU} is set to 2x the fault timeout period

Single PCI Express, Hot-Plug Controller

MAX5954

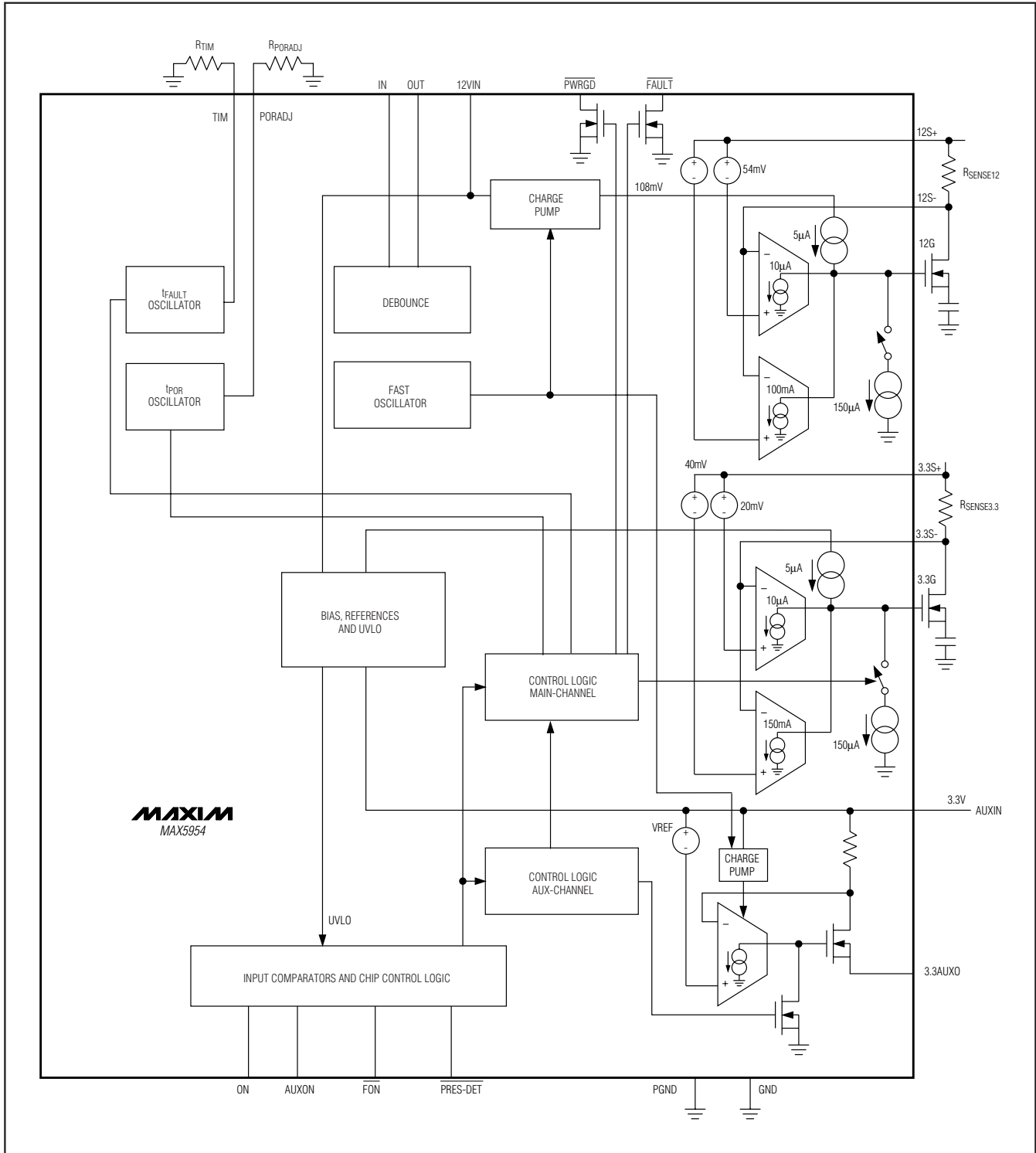

Figure 1. Functional Diagram

Single PCI Express, Hot-Plug Controller

Table 1. Power Requirements for PCI Express Connectors

POWER RAIL	X1 CONNECTOR	X4/8 CONNECTOR	X16 CONNECTOR
3.3V			
Voltage Tolerance	±9% (max)	±9% (max)	±9% (max)
Supply Current	3.0A (max)	3.0A (max)	3.0A (max)
Capacitive Load	1000µF (max)	1000µF (max)	1000µF (max)
12V			
Voltage Tolerance	±8% (max)	±8% (max)	±8% (max)
Supply Current	0.5A (max)	2.1A (max)	5.5A (max)
Capacitive Load	300µF (max)	1000µF (max)	2000µF (max)
3.3V AUXILIARY			
Voltage Tolerance	±9% (max)	±9% (max)	±9% (max)
Supply Current, Wake Enabled	375mA (max)	375mA (max)	375mA (max)
Supply Current, Non-Wake Enabled	20mA (max)	20mA (max)	20mA (max)
Capacitive Load	150µF (max)	150µF (max)	150µF (max)

Table 2. Control Logic Truth Table

ON	AUXON	$\overline{\text{FON}}$	$\overline{\text{PRES-DET}}$	12V AND 3.3V OUTPUTS	3.3VAUXO AUXILIARY OUTPUT
X	X	Low	X	On	On
X	X	High	High	Off	Off
Low	Low	High	Low*	Off	Off
High	Low	High	Low*	On	Off
Low	High	High	Low*	Off	On
High	High	High	Low*	On	On

*PRES-DET high-to-low transition has a 5ms delay (t_{DEG}).

(t_{FAULT}). RTIM externally connected from TIM to GND sets the duration of t_{FAULT} .

12V and 3.3V Outputs Normal Operation

The MAX5954 monitors and actively limits the current of the 12V and 3.3V outputs after the startup period. Each output has its own overcurrent threshold. If any of the monitored output currents rise above the overcurrent threshold for a period t_{FAULT} , $\overline{\text{FAULT}}$ asserts and the controller disengages both the 12V and 3.3V outputs (see the *Fault Management* section).

3.3V Auxiliary Output Normal Operation

The auxiliary output current is internally monitored and actively limited to the maximum current-limit value. An overcurrent fault condition occurs when the

output current exceeds the overcurrent threshold for longer than t_{FAULT} . A fault on an auxiliary channel causes all supplies to be disabled after a programmable time period t_{FAULT} (see the *Fault Management* section).

Power-Good ($\overline{\text{PWRGD}}$)

Power-good ($\overline{\text{PWRGD}}$) is an open-drain output that pulls low a time ($t_{\text{POR_HL}}$) after all of the outputs are fully on. All outputs are considered fully on when 3.3G has risen to $V_{\text{PGTH3.3}}$, 12G has risen to V_{PGTH12} , and $V_{3.3\text{AUXO}}$ is less than $V_{\text{PGTH3.3AUX}}$. $t_{\text{POR_HL}}$ is adjustable from 2.5ms to 1.5s by connecting a resistor from PORADJ to GND. See the *Setting the Power-On-Reset Timeout Period (t_{POR})* section.

Single PCI Express, Hot-Plug Controller

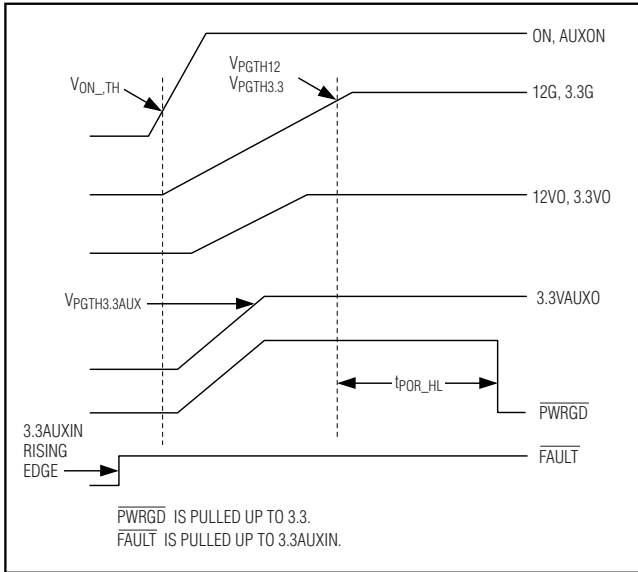

Figure 2. Power-Up Timing, No Fault

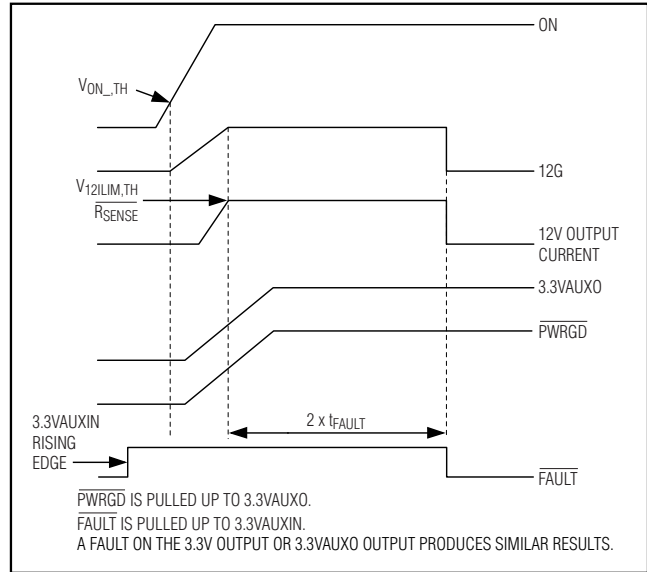

Figure 3. 12V Power-Up Timing (Turn-On into Output Overcurrent/Short Circuit)

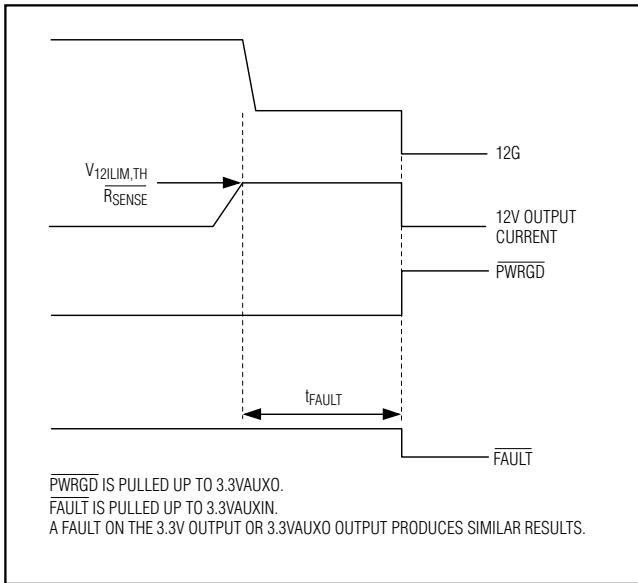

Figure 4. 12V Output Overcurrent/Short Circuit During Normal Operation

Thermal Shutdown

When the die temperature goes above +150°C (TSD), an overtemperature fault occurs and the MAX5954 shuts down all outputs. The device waits for the junction temperature to decrease below TSD - Hysteresis before entering fault management (see the *Fault Management* section).

Fault Management

A fault occurs when an overcurrent lasts longer than tFAULT or when the device experiences an overtemperature condition.

- A fault on a main output (12V or 3.3V) shuts down both main outputs. The 3.3V auxiliary is not affected.
- A fault on the 3.3V auxiliary output shuts down all three outputs.

The MAX5954A automatically restarts from a fault shutdown after the tRESTART period, while the MAX5954L latches off. If an overcurrent fault occurred on a main output, bring ON low for at least tRESET (100µs) and high again to reset the fault and restart the outputs. If the overcurrent fault occurred on an auxiliary output or an overtemperature fault occurred, bring both ON and AUXON low for a minimum of tRESET to reset the fault. Bring ON and/or AUXON high again to restart the respective outputs. As an extra protection, the MAX5954L waits a minimum of tRESTART before it can be restarted.

Debounced Logic Gate (Input and Output)

INPUT accepts an input from a mechanical switch. The corresponding output (OUTPUT) is debounced for 4.4ms. When INPUT goes from high to low, OUTPUT goes low right away and stays low for at least 4.4ms. After the debounce time OUTPUT follows INPUT. If INPUT goes from low to high, OUTPUT goes high right away and

Single PCI Express, Hot-Plug Controller

stays high for at least 4ms. After the debounce time, OUTPUT follows INPUT. Figure 5 shows the timing diagram describing the INPUT/OUTPUT debounced feature.

Present-Detect and Forced-On Inputs (PRES-DET, FON)

$\overline{\text{PRES-DET}}$ input detects the PRSNT#2 pin on a PCI Express connector. When the card is plugged in, $\overline{\text{PRES-DET}}$ goes low and allows the turn-on of the output after a 4ms debounced time. When the card is removed, an internal 50k Ω pullup forces $\overline{\text{PRES-DET}}$ high and the PCI Express slot is shut down with no delay. $\overline{\text{PRES-DET}}$ works in conjunction with ON and AUXON and only enables the device when ON and AUXON are high.

A logic-low on $\overline{\text{FON}}$ forces the PCI Express slot (main supplies and auxiliary) to turn on regardless of the status of the other logic inputs provided the UVLO thresholds are exceeded on all of the inputs.

Active Current Limits

Active current limits are provided for all three outputs. Connect a current-sense resistor between 12S+ and 12S- to set the current limit for the 12V output. The current limit is set to 54mV/RSENSE12. Connect a current-sense resistor between 3.3S+ and 3.3S- to set the current limit for the 3.3V main output to 20mV/RSENSE3.3. For the auxiliary output (3.3VAUXO) the current limit is fixed at 470mA.

When the voltage across RSENSE12 or RSENSE3.3 reaches the current-limit threshold voltage, the MAX5954 regulates the gate voltage to maintain the current-limit threshold voltage across the sense resistor. If the current limit lasts for t_{FAULT} , then an overcurrent fault occurs. The MAX5954 shuts down both the 12V and 3.3V outputs and asserts the $\overline{\text{FAULT}}$ output.

When the auxiliary output reaches the current limit (470mA) for longer than t_{FAULT} , a fault occurs and the device shuts down all outputs and asserts $\overline{\text{FAULT}}$.

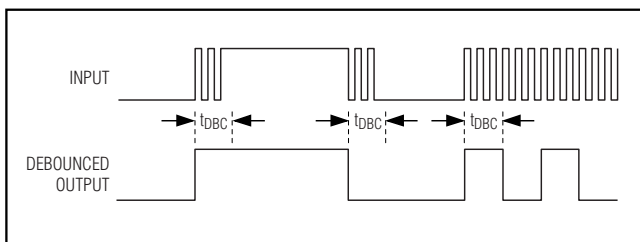

Figure 5. INPUT and OUTPUT Debounced Feature

Undervoltage-Lockout Threshold

The UVLO thresholds prevent the internal auxiliary MOSFET and the external main channel MOSFETs (Q1 and Q2 in the *Typical Application Circuit*) from turning on if V_{12VIN} , $V_{3.3VIN}$, and $V_{3.3VAUXIN}$ are not present. Internal comparators monitor the main supplies and the auxiliary supply and keep the gate-drive outputs (12G and 3.3G) low until the supplies rise above their UVLO threshold. The 12V main supply is monitored at 12VIN and has a UVLO threshold of 10V. The 3.3V main supply is monitored at 3.3S+ and has a UVLO threshold of 2.65V. The auxiliary supply is monitored at 3.3VAUXIN and has a 2.65V UVLO threshold. For the main outputs to operate, $V_{3.3VAUXIN}$ must be above its UVLO threshold.

External MOSFET Gate Driver (12G and 3.3G)

The gate drive for the external MOSFETs is provided at 12G and 3.3G. 12G is the gate drive for the 12V main supply and is boosted to 5.3V above V_{12VIN} by an internal charge pump. During turn-on, 12G sources 5 μ A into the external gate capacitance to control the turn-on time of the external MOSFET. During turn-off, 12G sinks 150 μ A from the external gate capacitance to quickly turn off the external MOSFET. During short-circuit events, an internal 120mA current activates to rapidly bring the load current into the regulation limits.

3.3G is the gate drive for the 3.3V main supply's MOSFET and is driven to 5.5V above the 3.3V main supply. The power for 3.3G is supplied from 12VIN and has no internal charge pump. During turn-on, 3.3G sources 5 μ A into the external gate capacitance to control the turn-on time of the external MOSFET. During turn-off, 3.3G sinks 150 μ A to quickly turn off the external MOSFET. During short-circuit events, an internal 150mA current activates to rapidly turn off the external MOSFET.

Auxiliary Supply (3.3VAUXIN)

3.3VAUXIN provides power to the auxiliary output as well as the internal logic and references. The drain of the internal auxiliary MOSFET connects to 3.3VAUXIN through internal sense resistor and the source connects to the auxiliary output 3.3VAUXO. The MOSFET's typical on-resistance is 0.3 Ω . An internal charge pump boosts the gate-drive voltage to fully turn on the internal n-channel MOSFET. The auxiliary supply has an internal current limit set to 470mA.

Single PCI Express, Hot-Plug Controller

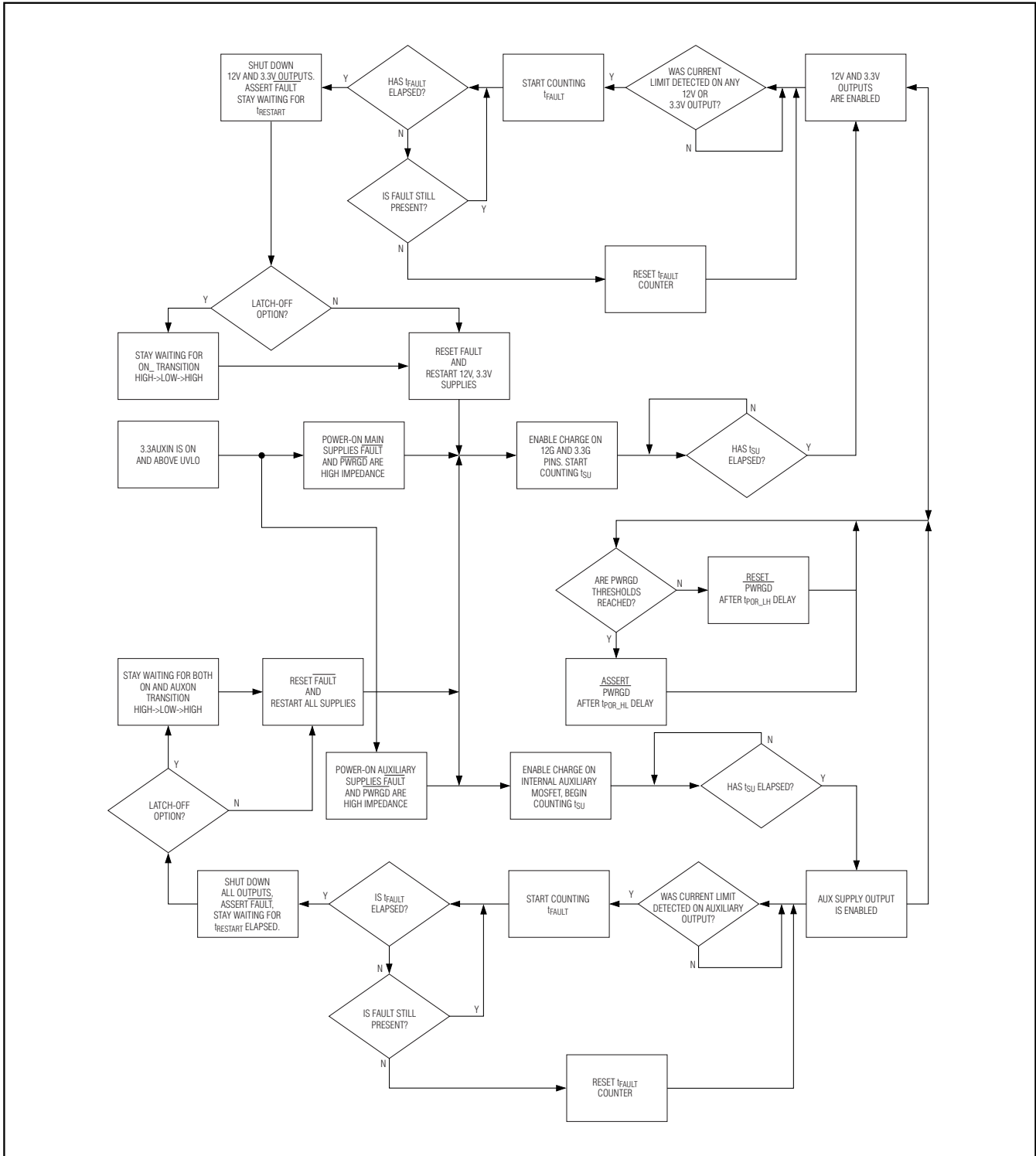

Figure 6. Fault Management Flow Chart

Single PCI Express, Hot-Plug Controller

Applications Information

Setting the Fault Timeout Period (t_{FAULT})

t_{FAULT} is the time an overcurrent or overtemperature fault must remain for the MAX5954 to disable the main or auxiliary outputs. Program the fault timeout period (t_{FAULT}) by connecting a resistor (R_{TIM}) from TIM to GND. t_{FAULT} can be calculated by the following equation:

$$t_{FAULT} = 166\text{ns} / \Omega \times R_{TIM}$$

The t_{FAULT} programmed time duration must be chosen according to the total capacitance load connected to 12G and 3.3G. To properly power-up the main supply outputs, the following constraints need to be taken:

$$t_{SU} \geq \frac{V_{GATE} \times C_{LOAD}}{I_{CHG}}$$

where $t_{SU} = 2 \times t_{FAULT}$ and where:

- 1) $I_{CHG} = 5\mu\text{A}$.
- 2) $V_{GATE} = 18.4\text{V}$ for 12G and $V_{GATE} = 9.4\text{V}$ for 3.3G.
- 3) C_{LOAD} is the total capacitance load at the gate.

Maximum and minimum values for R_{TIM} are $500\text{k}\Omega$ and 500Ω , respectively. Leave TIM floating for a default t_{FAULT} of 11ms.

Setting the Power-On-Reset Timeout Period (t_{POR_HL})

t_{POR_HL} is the time from when the gate voltages of all outputs reach their power-good threshold to when $\overline{\text{PWRGD}}$ pulls low. Program the power-on-reset timeout period (t_{POR}) by connecting a resistor (R_{PORADJ}) from PORADJ to GND. t_{POR_HL} can be calculated by the following equation:

$$t_{POR_HL} = 2.5\mu\text{s} / \Omega \times R_{PORADJ}$$

Maximum and minimum values for R_{PORADJ} are $500\text{k}\Omega$ and 500Ω , respectively. Leave PORADJ floating for a default t_{POR} of 160ms.

Component Selection

Select the external n-channel MOSFET according to the applications current requirement. Limit the switch power dissipation by choosing a MOSFET with an R_{DS_ON} low enough to have a minimum voltage drop at full load. High R_{DS_ON} causes larger output ripple if there are pulsed loads. High R_{DS_ON} can also trigger an external undervoltage fault at full load. Determine the MOSFET's power rating requirement to accommodate a short-circuit condition on the board during startup. Table 3 lists MOSFETs and sense-resistor manufacturers.

Additional External Gate Capacitance

External capacitance can be added from the gate of the external MOSFETs to GND to slow down the dV/dt of the 12V and 3.3V outputs.

Maximum Load Capacitance

Large capacitive loads at the 12V output, the 3.3V output, and the 3.3V auxiliary output can cause a problem when inserting discharged PCI cards into live backplanes. A fault occurs if the time needed to charge the capacitance of the board is greater than the typical startup time ($2 \times t_{FAULT}$). The MAX5954 can withstand large capacitive loads due to their adjustable startup times and adjustable current-limit thresholds. Calculate the maximum load capacitance as follows:

$$C_{LOAD} < \frac{t_{SU} \times I_{LIM}}{V_{OUT}}$$

V_{OUT} is either the 3.3V output, the 12V output, or the 3.3V auxiliary output.

Table 3. Component Manufacturers

COMPONENT	MANUFACTURER	PHONE	WEBSITE
Sense Resistor	Vishay-Dale	402-564-3131	www.vishay.com
	IRC	704-264-8861	www.irctt.com
MOSFETs	Fairchild	888-522-5372	www.fairchildsemi.com
	International Rectifier	310-322-3331	www.irf.com
	Motorola	602-244-3576	www.mot-sps.com/ppd/
	Vishay-Siliconix	—	www.vishay.com

Single PCI Express, Hot-Plug Controller

Input Transients

The 12V input (12VIN), the 3.3V input (3.3S+), and the 3.3V auxiliary (3.3VAUXIN) must be above their UVLO thresholds before startup can occur. Input transients can cause the input voltage to sag below the UVLO threshold. The MAX5454 rejects transients on the input supplies that are shorter than 4 μ s (typ).

Chip Information

PROCESS: BiCMOS

Single PCI Express, Hot-Plug Controller

Package Information

(The package drawing(s) in this data sheet may not reflect the most current specifications. For the latest package outline information, go to www.maxim-ic.com/packages.)

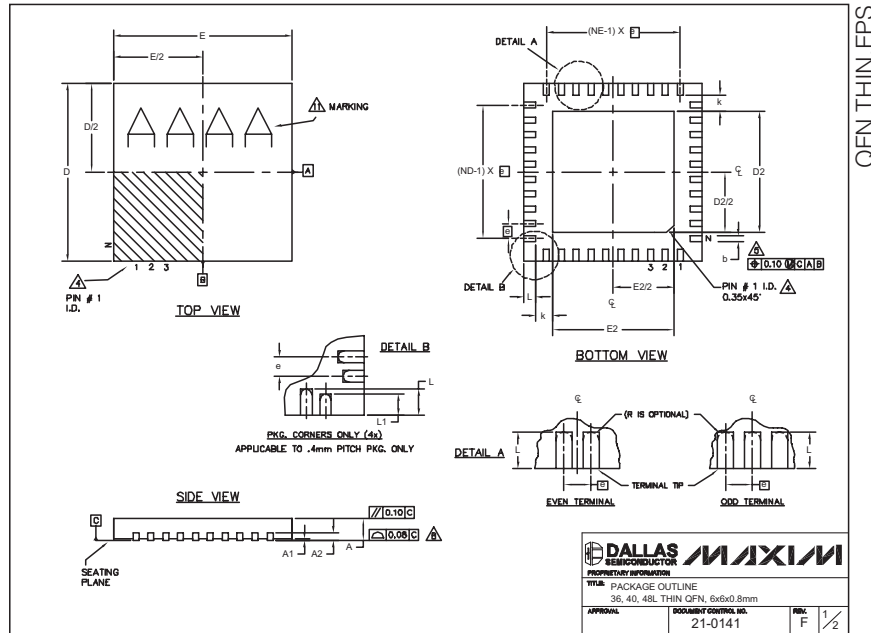

QFN THIN.EPS

COMMON DIMENSIONS									
PKG. SYMBOL	36L 6x6			40L 6x6			48L 6x6		
	MIN.	NOM.	MAX.	MIN.	NOM.	MAX.	MIN.	NOM.	MAX.
A	0.70	0.75	0.80	0.70	0.75	0.80	0.70	0.75	0.80
A1	0	0.02	0.05	0	0.02	0.05	0	—	0.05
A2	0.20 REF.			0.20 REF.			0.20 REF.		
b	0.20	0.25	0.30	0.20	0.25	0.30	0.15	0.20	0.25
D	5.90	6.00	6.10	5.90	6.00	6.10	5.90	6.00	6.10
E	5.90	6.00	6.10	5.90	6.00	6.10	5.90	6.00	6.10
e	0.50 BSC.			0.50 BSC.			0.40 BSC.		
k	0.25	—	—	0.25	—	—	0.25	0.35	0.45
L	0.45	0.55	0.65	0.30	0.40	0.50	0.40	0.50	0.60
L1	—	—	—	—	—	—	0.30	0.40	0.50
N	36			40			48		
ND	9			10			12		
NE	9			10			12		
.JEDEC	WJ4D-1			WJ4D-2			—		

PKG. CODES	EXPOSED PAD VARIATIONS						DOWN BONDS ALLOWED
	D2			E2			
	MIN.	NOM.	MAX.	MIN.	NOM.	MAX.	
T3666-2	3.60	3.70	3.80	3.60	3.70	3.80	YES
T3666-3	3.60	3.70	3.80	3.60	3.70	3.80	NO
T3666N-1	3.60	3.70	3.80	3.60	3.70	3.80	NO
T4066-2	4.00	4.10	4.20	4.00	4.10	4.20	YES
T4066-3	4.00	4.10	4.20	4.00	4.10	4.20	YES
T4066-4	4.00	4.10	4.20	4.00	4.10	4.20	NO
T4066-5	4.00	4.10	4.20	4.00	4.10	4.20	NO
T4866-1	4.20	4.30	4.40	4.20	4.30	4.40	YES

NOTES:

- DIMENSIONING & TOLERANCING CONFORM TO ASME Y14.5M-1994.
- ALL DIMENSIONS ARE IN MILLIMETERS. ANGLES ARE IN DEGREES.
- N IS THE TOTAL NUMBER OF TERMINALS.
- THE TERMINAL #1 IDENTIFIER AND TERMINAL NUMBERING CONVENTION SHALL CONFORM TO JESD 95-1 SPP-012. DETAILS OF TERMINAL #1 IDENTIFIER ARE OPTIONAL, BUT MUST BE LOCATED WITHIN THE ZONE INDICATED. THE TERMINAL #1 IDENTIFIER MAY BE EITHER A MOLD OR MARKED FEATURE.
- DIMENSION 9 APPLIES TO METALLIZED TERMINAL AND IS MEASURED BETWEEN 0.25 mm AND 0.30 mm FROM TERMINAL TIP.
- ND AND NE REFER TO THE NUMBER OF TERMINALS ON EACH D AND E SIDE RESPECTIVELY.
- DEPOPULATION IS POSSIBLE IN A SYMMETRICAL FASHION.
- COPLANARITY APPLIES TO THE EXPOSED HEAT SINK SLUG AS WELL AS THE TERMINALS.
- DRAWING CONFORMS TO JEDEC MO220, EXCEPT FOR 0.4mm LEAD PITCH PACKAGE T4866-1.
- WARPAGE SHALL NOT EXCEED 0.10 mm.
- MARKING IS FOR PACKAGE ORIENTATION REFERENCE ONLY.
- 12: NUMBER OF LEADS SHOWN FOR REFERENCE ONLY.

APPROVAL

DOCUMENT CONTROL NO. 21-0141

REV. F

1/2

Maxim cannot assume responsibility for use of any circuitry other than circuitry entirely embodied in a Maxim product. No circuit patent licenses are implied. Maxim reserves the right to change the circuitry and specifications without notice at any time.

22 **Maxim Integrated Products, 120 San Gabriel Drive, Sunnyvale, CA 94086 408-737-7600**